

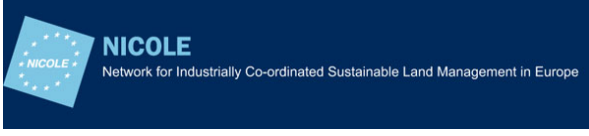

European Union Network for the Implementation
and Enforcement of Environmental Law



Working Group
Contamination

Toprak Gazı Ekstraksiyonu (SVE) Raporu

Final Raporu

Rapor Tarihi: 8 Kasım 2021
Rapor Numarası: 2020/09 SVE TR

IMPEL'e Giriş/ IMPEL Hakkında

Avrupa Birliđi Çevre Yasası Uygulama ve Yürütme Ađı (IMPEL), Avrupa Birliđi (AB) üye devletlerinin, AB'ye katılan ve AB'ye aday ülkelerin ve Avrupa Ekonomik Alanı(AEA) ülkelerinin çevre yetkililerinin kâr amacı gütmeyen uluslararası bir derneđidir. IMPEL Derneđi Belçika'da kayıtlıdır ve yasal merkezi Belçika'nın Brüksel şehrindeyir.

IMPEL, 1992 yılında, çevre hukukunun uygulanması ve icrası ile ilgili resmi olmayan bir Avrupa düzenleyicileri ve yetkilileri Ađı olarak kurulmuştur. Ađın amacı, Avrupa Topluluđunda çevre mevzuatının daha etkin bir şekilde uygulanmasını sağlama konusunda ilerleme sağlamak için gerekli ivmeyi yaratmaktır. IMPEL faaliyetlerinin özü, uygulama, yürütme ve uluslararası yaptırım işbirliđi hakkında farkındalık artırma, kapasite oluşturma ve bilgi ve deneyim alışverişi ile Avrupa çevre mevzuatının uygulanabilirliđini ve uygulanabilirliđini teşvik etmek ve desteklemekle ilgilidir.

Yıllar içerisinde IMPEL, bir dizi AB yasama ve politika belgesinde adı geçen, hatırı sayılır, yaygın olarak bilinen bir organizasyon haline geldi, (örn. 7. Çevre Eylem Programı ve Çevre Denetimleri için Asgari Kriterlere ilişkin Tavsiye)

IMPEL'deki katılımcıların uzmanlıđı ve deneyimi, bu ađı AB Çevre Mevzuatının hem teknik, hem de düzenleyici yönlerinde çalışmak için benzeriz şekilde nitelikli hale getirmektedir.

IMPEL Ađı ile ilgili bilgiler ayrıca şu adresteki web sitesinde de mevcuttur:www.impel.eu

Suggested citation:

Falconi M. et al. (2021), Toprak Gazı Ekstraksiyonu (SVE) Raporu. IMPEL, COMMON FORUM, EIONET, NICOLE report no 2020/09 SVE TR, 299 pages. Brussels, ISBN 978-2-931225-19-6

ISBN 978-2-931225-19-6



9 782931 225196

Rapor Başlığı: Toprak Gazı Ekstraksiyonu (Soil Vapor Extraction- SVE)	Rapor Numarası: 2020/09 SVE TR	
IMPEL Genel Kurul Toplantısında Kabul Edilen Rapor: 7-8 Aralık 2021, Ljubljana (Slovenya)	Toplam Sayfa No: 299 Rapor: 47 sayfa Ekler: 252 sayfa	
Proje Yöneticileri:		
Marco Falconi (IT)	IMPEL	ISPRA
Dietmar Müller-Grabherr (AT)	Common Forum	Umweltbundesamt AT
Frank Swartjes (NL)	EIONET WG Contamination	RIVM
Tomas Albergaria (PT)	NICOLE	Instituto Politécnico do Porto
Yazarlar:		
Dietmar Müller-Grabherr (AT)	Common Forum	Umweltbundesamt AT
Tomas Albergaria (PT)	NICOLE	Instituto Politécnico do Porto
Francesca Benedetti (IT)	IMPEL	MITE (Consultant)
Ezgi Bahar Çilesiz (TR)	-	ECOTORA
Said El Fadili (BE)	IMPEL	ENVIRONNEMENT BRUSSELS
Marco Falconi (IT)	IMPEL	ISPRA
Federico Fuin (IT)	IMPEL	ARPAV
Gabriella Grima (MT)	IMPEL	ERA
Güray Hatipoğlu (TR)	-	FARMLABS
Gokberk Kara (TR)	-	RSK
Dirk Krebs (DE)	IMPEL	REGIERUNGSPRÄSIDIUM DARMSTADT
Christina Pisani (MT)	IMPEL	ERA
Alex Plows (UK)	IMPEL	CYFOETHNATURIOLCYMRU
Andrea Sconocchia (IT)	IMPEL	ARPA UMBRIA
Asa Valley (SE)	EIONET WG Contamination	NATURVÅRDSVERKET
ISCO EK 1'e Katkı Sağlayanlar:		
Federico Caldera (IT)	MARES	
Simone De Fazio (IT)	GOLDER ASSOCIATES	
Boris Devic-Bassaget (FR)	SUEZ RR IWS REMEDIATION FRANCE	
Paola Canepa (IT)	ARPA LOMBARDIA	
Massimiliano Confalonieri (IT)	ARPA LOMBARDIA	
Sophia Dore (US)	GHD	
Alain Duchene (BE)	HAEMERS TECHNOLOGIES	
Daniela Fiaccavento (IT)	ARPAV	
René Fillion (US)	GHD	
Jan Haemers (BE)	HAEMERS TECHNOLOGIES	
Aline Jordens (BE)	HAEMERS TECHNOLOGIES	
Angela Rosa Marin (IT)	ARPA LOMBARDIA	
Valter Meda (IT)	ARPA LOMBARDIA	
Davide Menozzi (AU)	GHD	
Paola Panzeri (IT)	ARPA LOMBARDIA	
Mathieu Petitjean (BE)	HAEMERS TECHNOLOGIES	
Sara Puricelli (IT)	ARPA LOMBARDIA	

Jean Rhone (FR)	HAEMERS TECHNOLOGIES
Diego Ricci (IT)	ARPA LOMBARDIA
Hatem Saadaoui (BE/TN)	HAEMERS TECHNOLOGIES
Luca Sacilotto (IT)	RAMBOLL
Valentina Sammartino (IT)	ARPA CAMPANIA
Hadas Sharon (IL)	LUDAN ENVIRONMENTAL TECHNOLOGIES
Ewa Szczebak (PL)	ARCADIS
Corrado Thea (IT)	GOLDER ASSOCIATES
Aldo Trezzi (IT)	RAMBOLL
Mathieu Vion (FR)	SUEZ RR IWS REMEDIATION FRANCE
Okuyucu ve Eleştirmenler:	
Federico Caldera (IT)	MARES
Craig Cox (US)	COX COLVIN & ASSOCIATES
Mathieu Petitjean (BE)	HAEMERS TECHNOLOGIES
Yönetici Özeti	
Anahtar Kelimeler	
Toprak Gazı/Buharı Çıkarma, Sürdürülebilir İyileştirme, Toprak, Yeraltı Suyu, Toprak Politikası, İyileştirme, Çevre, Net arazi alımı olmaması, Kirlilik, Kirlenmiş tesisler, Kirlenme, Kirlenmiş sahalar, İzleme, Saha testi.	
Hedef Gruplar	
İyileştirme teknolojisi onayı/uygulaması/izlenmesi için yetkili makamlar, endüstriyel operatörler, çevre koruma kurumları, doğa koruma kuruluşları, çevre müfettişlikleri, çevre izleme ve araştırma kurumları, teknik üniversiteler, çevre dernekleri, STK'lar, sigorta şirketleri ve dernekleri, çevre danışmanları.	
2020 Çalışma Programının bir parçası olarak, IMPEL Ağı, iyileştirme teknolojilerinin uygulanabilirliğini değerlendirme kriterleri ile ilgili olarak bu Su ve Arazi İyileştirme (Water and Land Remediation 2020/09) projesini kurdu.	
Su ve Arazi İyileştirme projesi, iyileştirme teknolojisi uygulamasının tanımları ve temel adımları hakkında bir sıçrama tahtası olarak rehberlik eder ve iyileştirme teknolojileriyle bağlantılı teknik prosedürlere odaklanır. Projenin nihai amacı, iyileştirme teknolojisi uygulama önerisinin değerlendirilmesi için kriterleri kanıtlayan, uygulanabilirliğini, saha testlerinde ne yapılması gerektiğini ve tam ölçekli uygulamada bir belge üretmektir. Ek 1, okuyucunun karşılaşılabilecekleri herhangi bir sorunu tahmin etmesine ve sağlanan çözümün kendi sahası için geçerli olup olmadığını görmesine yardımcı olabilecek, her kontamine alanın diğerlerinden farklı olduğunu ve sahaya özel bir yaklaşıma ihtiyaç duyulduğunu bilerek bir dizi vaka çalışmasını kapsar.	
2020-2021 için Su ve Arazi İyileştirme projesinin amacı, Yerinde Kimyasal Oksidasyon(ISCO) ve Toprak Gazı Ekstraksiyonu(SVE) olmak üzere iki iyileştirme teknolojisine odaklanmaktır.	
Son olarak, Su ve Arazi İyileştirme projesi, toprak ve yeraltı suyu için yerinde ve yerinde iyileştirme teknolojilerinin uygulanmasını ve Avrupa'da yaygın olarak kullanılan ancak Avrupa'da sürdürülebilir olmayan Kazı ve Boşaltma ve Pompala ve Aritma tekniklerinin daha az uygulanarak orta-uzun vadeli olarak katkıda bulunmayı amaçlamaktadır. Toprak ve su doğal kaynaklardır ve teknik olarak mümkün olduğunda israf edilmeden geri kazanılmalıdır.	

Teşekkürler

Bu rapor, daha geniş bir IMPEL proje ekibi ve IMPEL Su ve Arazi Uzman Ekibi, ORTAK FORUM ağı, NICOLE ağı, EIONET WG Kontaminasyon ve bir grup harici uzman kişiler tarafından gözden geçirilmiştir.

Sorumluluk Reddi

Bu yayın, Kirlenmiş Arazi Yönetimi ile ilgilenen ortak ağların desteğiyle IMPEL Su ve Arazi iyileştirme projesi kapsamında hazırlanmıştır. Bir yazarlar ekibi tarafından yazılan ve gözden geçirilen bu belge, AB ülkeleri ve bölgeleri arasında köprü kurmak, bilgiyi genişletmek için birincil bilgi kaynağı olarak hizmet etmeyi amaçlamaktadır. Ortak bir anlayışa destek sağlamayı amaçlarken, iyileştirme teknolojisinin potansiyellerini de spesifik olarak kolaylaştırmaya çalışmaktadır.

Burada rapor edilen içerik, ilgili kaynakça, yazarların deneyimi ve toplanan vaka incelemelerine dayanmaktadır. Belge, bu teknolojinin uygulandığı veya uygulanacağı tüm durumlarda kapsamlı olmayabilir. Vaka çalışmaları (bkz. ek) gönüllü katkılar olarak kabul edilir. Yazarlar ekibinin vaka çalışması raporlarını değerlendirmek veya doğrulamak gibi bir görevi yoktur.

Ayrıca bazı ülkeler, bölgeler veya yerel makamlar, teknoloji uygulamalarını çerçevelemek için belirli mevzuat, kurallar veya yönergeler başlatmış olabilir, bu uygulanabilmektedir.

Bu belge, bu teknoloji için bir kılavuz veya Uygulanabilir En İyi Teknoloji Referans Belgesi olarak tasarlanmamıştır. Avrupa genelinde kirlenmiş alanların pedolojik, jeolojik ve hidrojeolojik ayarları geniş bir değişkenlik göstermektedir. Bu nedenle, kişiye özel sahaya özel tasarım ve uygulama, kontamine alanların iyileştirilmesinde başarının anahtarıdır. Dolayısıyla bildirilen herhangi bir tavsiye uygulanabilir, kısmen uygulanabilir veya uygulanmayabilir. Her durumda, yazarlar, katkıda bulunanlar, ilgili ağlar sorumlu tutulamaz.

Bu belgede ifade edilen görüşler, mutlaka aşağıda imzası bulunan ağların bireysel üyelerine ait değildir. IMPEL ve ortak ağları, teknolojiyi pratikte uygulamakla ilgilenen bireylerin/kuruluşların deneyimli çevre profesyonellerinin hizmetlerini sürdürmelerini şiddetle tavsiye etmektedir.

Marco Falconi – IMPEL

Dietmar Müller Grabherr – COMMON FORUM on Contaminated Land in Europe

Frank Swartjes – EEA EIONET WG Contamination

Tomas Albergaria – NICOLE

Terimler

TERİM	AÇIKLAMA	KAYNAK	PARAGRAF
'uyum noktası'	değerlendirme kriterlerinin ölçüleceği ve aşılmayacağı yer (örneğin, toprak veya yeraltı suyu)	ISO EN 11074	3.4.5
'uyum veya performans kontrolü'	Bir iyileştirme stratejisinin uygun şekilde uygulandığını (örneğin, tüm kirleticilerin ortadan kaldırıldığını) ve/veya bir sınırlama yaklaşımının benimsendiğini, bunun belirtilen seviye	ISO EN 11074	6.1.5
'kirletici' ¹	İnsan faaliyetleri sonucu toprakta bulunan madde(ler) veya ajan(lar)	ISO EN 11074	3.4.6
'kirlenmiş saha' ²	Kontaminasyonun/kirliliğin mevcut olduğu saha/yer/alan	ISO EN 11074	2.3.5
'kirlilik'	İnsan faaliyetleri sonucu toprakta bulunan madde(ler) veya ajan(lar)	ISO EN 11074	2.3.6
'verimlilik' ³	<iyileştirme yöntemi> bir iyileştirme yönteminin gerekli bir performansı elde etme yeteneğinin ölçüsü	ISO EN 11074	6.1.6
'emiyon'	Münferit veya dağınık kaynaklardan havaya, suya veya toprağa doğrudan veya dolaylı olarak madde, titreşim, ısı veya gürültü salınımı	IED	Art. 3 (4)
'çevresel kalite standardı'	Birlik hukukunda belirtildiği gibi, belirli bir çevre veya bunun belirli bir bölümü tarafından belirli bir zamanda yerine getirilmesi gereken gereksinimler dizisi;	IED	Art. 3 (6)
'Henry katsayısı'	toprak havası ve toprak suyu arasındaki bölme katsayısı	ISO EN 11074	3.3.12
'yerinde iyileştirme metodu' ⁴	Kirlenmiş matrisi topraktan çıkarmadan doğrudan işlenen çevresel ortama (örneğin toprak, yeraltı suyu) uygulanan arıtma yöntemi	ISO EN 11074	6.2.3
'sızma'	Çözünen maddelerin sui le çözülmesi ve hareketi	ISO EN 11074	3.3.15

¹ Bu tanımda, kontaminasyonun varlığından kaynaklanan zararlar varsayımı yoktur.

² Bu tanımda, kontaminasyonun varlığından kaynaklanan zararlar varsayımı yoktur.]

³ Prosese dayalı yöntem söz konusu olduğunda, etknlik, elde edilen kalıntı, kirletici konsantrasyonları cinsinden ifade edilebilir.

⁴ Not: ISO CD 241212 eş anlamı olarak şunu önerir: 'in-situ (remediasyon) tekniği' [Giriş için not 1: Bu tür iyileştirme kurulumu sahada yapılır ve kirleticiyi arıtma eyleminin doğrudan yeraltına uygulanması amaçlanır.] ISO CD 24212 3.1

'kirletici/kirleten madde'	Toprakta (veya yeraltı suyunda) bulunan ve özellikleri, miktarı veya konsantrasyonu nedeniyle toprak fonksiyonları üzerinde olumsuz etkilere neden olan madde(ler) veya ajan(lar)	ISO EN 11074	3.4.18
'kirlilik'	insan faaliyeti sonucunda, insan sağlığına veya çevrenin kalitesine zararlı olabilecek, maddi mülkiyete zarar verebilecek veya zarar verebilecek maddelerin, titreşimlerin, ısının veya gürültünün havaya, suya veya toprağa doğrudan veya dolaylı olarak girmesi veya çevrenin olanaklarına ve diğer meşru kullanımlarına müdahale etmek;	IED	Art. 3 (2)
'iyileştirme hedefi'	teknik (ör. artık kontaminasyon konsantrasyonları, mühendislik performansı), idari ve yasal gereklilikler ile ilgili olanlar da dahil olmak üzere herhangi bir amaç için genel terim	ISO EN 11074	6.1.19
'remediation/ iyileştirme stratejisi' ⁵	kontaminasyonla ilgili belirli hedefleri (örneğin artık kirletici konsantrasyonları) ve diğer hedefleri (örneğin mühendislikle ilgili) karşılayacak ve sahaya özgü kısıtlamaların üstesinden gelecek iyileştirme yöntemleri ve ilgili çalışmaların kombinasyonu	ISO EN 11074	6.1.20
'iyileştirme hedef değeri'	İyileştirme ile elde edilecek performansın göstergesi, genellikle kalıntı konsantrasyonu açısından kontaminasyonla ilgili amaç olarak tanımlanır.	ISO EN 11074	6.1.21
'doymuş bölge'	Gözetim anında gözenek boşluğunun tamamen sıvı ile dolu olduğu zemin bölgesi.	ISO EN 11074	3.2.6
'toprak'	ana kaya ile yüzey arasında yer alan yerkabuğunun en üst tabakası. Toprak, mineral parçacıklar, organik madde, su, hava ve canlı organizmalardan oluşur;	IED	Art. 3 (21)
'toprak gazı'	Toprağın gözenek ve boşluklarındaki buhar/gaz	ISO EN 11074	2.1.13
'doymamı bölge'	Gözetim anında gözenek boşluğunun tamamen sıvı ile doldurulmadığı zemin bölgesi.	ISO EN 11074	3.2.8

⁵ Yöntemlerin seçimi, topoğrafya, jeoloji, hidrojeoloji, taşkın eğilimi ve iklim gibi çeşitli sahaya özgü faktörler tarafından kısıtlanabilir.

İÇİNDEKİLER TABLOSU

1	GİRİŞ	10
1.1	TOPRAK GAZI/BUHARI EKSTRAKSİYONU (SVE) Yöntemi Geçmişi Hakkında	10
1.2	Toprak Gazı Ekstraksiyonu (SVE) Uygulanabilirliği	10
1.3	TOPRAK GAZI EKSTRAKSİYONU (SVE) Uygulanması	11
2	TEKİNİN AÇIKLAMASI	12
2.1	Genel Proses Açıklaması	12
2.2	Sistem Tekniği ve Bileşenleri	12
2.3	Kirleticilerin Arıtılabilirliği	13
2.4	Jeolojik Ortamın Dikkate Alınması	13
2.5	Sistemi Tasarlamak İçin Hususlar	14
3	FİZİBİLİTE ÇALIŞMASI	17
3.1	Saha Koşulları ve Kavramsal Saha Modeli	17
3.1.1	Kirlenmenin Doğası ve Kapsamı	18
3.1.2	Kaynağın Geometrik Karakteristiği	19
3.1.3	Suyla Karışmayan Sıvı Tehlikeli Kimyasal Maddenin (NAPL)'nin Mevcudiyeti	20
3.1.4	Toprak Gazı Araştırması Sonucu	20
3.1.5	Hava Geçirgenliği	20
3.1.6	Heterojenlikler ve Tercihli Ulaşım Yolları	20
3.1.7	Topoğrafya	21
3.2	SVE İyileştirme Tasarımında Sınama-Ölçek Testinin Kullanımları	21
3.3	SVE Fizibilite Değerlendirmesi	24
4	ARAZİ DENEYLERİ	26
4.1	Geleneksel /Bilinen Pilot Test	28
4.1.1	Geleneksel Pilot Test Ekipmanları	30
4.1.2	TGE'de artan vakum basamağı testi	30
4.1.3	TGE Sabit Vakum Testi	33
4.2	Helyum Dağılımı ve Geri Kazanımı Testi	34
4.3	Toprak Gazı İzlemesi	35
4.4	TGE arazi denemesi için minimum olması gereken ekipmanlar	36
4.5	Ekstraksiyon Kuyusu	36
4.6	Pilot Test Önerisi - Minimum Başvuru Gereklilikleri	37
4.7	Pilot Test Alternatifi	38

5	PERFORMANSIN İZLENMESİ	39
5.1	Operasyonel Faz İzlemesi	39
5.1.1	Kimyasal Parametreler	39
5.1.2	Fiziksel Parametreler	39
5.1.3	Meteorolojik	40
5.2	Temizlemenin Onaylanması ve Sistemin Kapatılması	40
5.2.1	Temizleme Onaylanması ile Değerlendirilebilecek Olası Kanıt Kaynakları	41
5.2.2	Kapanış Örneklemesi için Önerilen Prosedür	43
6	SONUÇLAR	44
6.1	Verimlilik, Avantajlar ve Dezavantajlar	44
6.2	TGE uygulamasının Operasyonel Kontrolü	45
	KAYNAKÇA	46

1 GİRİŞ

Avrupa Birliđi Çevre Yasasının Uygulanması ve Uygulanması Ađı olan IMPEL, Su ve Arazi İyileřtirme (WLR) projesi kapsamında, en yaygın ve en çok kullanılan toprak ve yeraltı suyu iyileřtirme teknolojilerine odaklanan bir dizi kılavuz geliřtirmektedir. Bu yönergeler, site sahipleri, çevredeki topluluk, proje yöneticileri, yükleniciler, düzenleyiciler ve diđer uygulayıcılar gibi farklı paydařların her bir iyileřtirme projesinden çıkan tüm bilgileri anlamalarına yardımcı olabilecek bu iyileřtirme teknolojileri hakkındaki en son ve en güncel bilgileri özetlemektedir. Hakemli bilimsel kaynaklarda ve resmi raporlarda elde edilen ilgili katkıda bulunanlardan sađlanan bilgileri kullanır.

Eldeki kılavuz, en sık kullanılan iyileřtirme teknolojilerinden biri olan Toprak Buharı Ekstraksiyonu (SVE) hakkında en son bilgileri derlemiřtir.

1.1 TOPRAK GAZI/BUHARI EKSTRAKSİYONU (SVE) Yöntemi Geçmiři Hakkında

Toprak Gazı Ekstraksiyonu (Toprak Havalandırma, Yerinde Toprak Havalandırma, Toprak Vakumlu Ekstraksiyon veya Vakumlu Ekstraksiyon gibi ilgili teknolojiler) en çok kullanılan toprak iyileřtirme teknolojilerinden biri olmuřtur [FRTR 2020]. Son on yıllardaki yaygın kullanımı nedeniyle SVE, günümüzde, doymamıř (veya vadoz) bölgedeki uçucu (veya sahaya özel olarak da yarı uçucu) organik bileřiklerle kirlenmiř toprakların iyileřtirilmesi için kabul görmüř, iyi kurulmuř ve etkili bir teknolojidir [Suthersan 1999].

Bir SVE sürecinin tipik bir řeması řekil 1.1'de sunulmaktadır. SVE, üfleyiciler/pompalar tarafından oluřturulan vakum kořullarının indüksiyonu ile toprakta oluřturulan bir hava akımı kullanarak bunları taşımak için kirleticilerin yüksek uçuculuđunu kullanır. Bu hava/buhar hareketi, kirleticileri, onları uygun řekilde geri kazanıldıkları veya tedavi edildikleri yüzeyin üzerinde bulunan gaz dıřı arıtma sistemlerine aktaran ekstraksiyon kuyularına taşır. En yaygın arıtma mekanizmaları, aktif karbon üzerine adsorpsiyon ve katalitik veya termal oksidasyon yoluyla yok suretiyle giderim sađlanmaktadır [EPA 2018, Soares 2012].

SVE çok yönlü bir iyileřtirme teknolojisidir ve yalnızca kirleticilerin buharlařmasına ve geri kazanılmasına odaklanarak tek bařına veya biyolojik bozunma (ör. sırasıyla doymamıř ve/veya doymuř bölgelere uygulandıđında "biyo"-serpme) veya desorpsiyon (elektrik direnci veya sıcak hava/buhar enjeksiyonu gibi ısıtma iřlemlerini kullanan, kirleticilerin buharlařma oranını artırmak ve kolaylařtırmak için termal olarak geliřtirilmiř SVE). SVE'nin toprađın doymamıř bölgesinde oluřturduđu hava/buhar akıřı, topraktaki hareketliliđini artırarak kirleticilerin uęmasını teřvik eder; ve uçucu kirleticilerin ekstraksiyon kuyularına tařınmasını artırır [Suthersan 1999, EPA 2018]. Genellikle toprak havalandırmasında kullanılan gibi daha düřük hava/buhar akıř hızları, toprak matrisinde teřvik edilen havalandırma yoluyla bozunabilir bileřiklerin biyolojik olarak bozunmasını destekler.

1.2 Toprak Gazı Ekstraksiyonu (SVE) Uygulanabilirliđi

Saha özellikleri ile ilgili olarak, SVE genellikle düřük/orta organik madde ve nem içeriđine sahip ve yeraltı suyuna olan derinlikleri 2 ila 30 m aralıđında olan geęirgen topraklar için etkilidir. Kirleticilerin türü göz önüne alındıđında, SVE halojenli ve halojenli olmayan uçucu organik bileřikler (VOC'ler) için etkinlik, halojenli ve halojenli olmayan yarı uçucu organik bileřikler (SVOC'ler) için sınırlı etkinlik, ortaya çıkan bazı kirleticiler (1,4-dioksan veya - ve polifloroalkil maddeler (PFAS) ve yakıtlar; ve inorganik kirleticiler, radyonüklidler ve mühimmat için geęerli deđildir [FRTR 2020, EPA 2018].

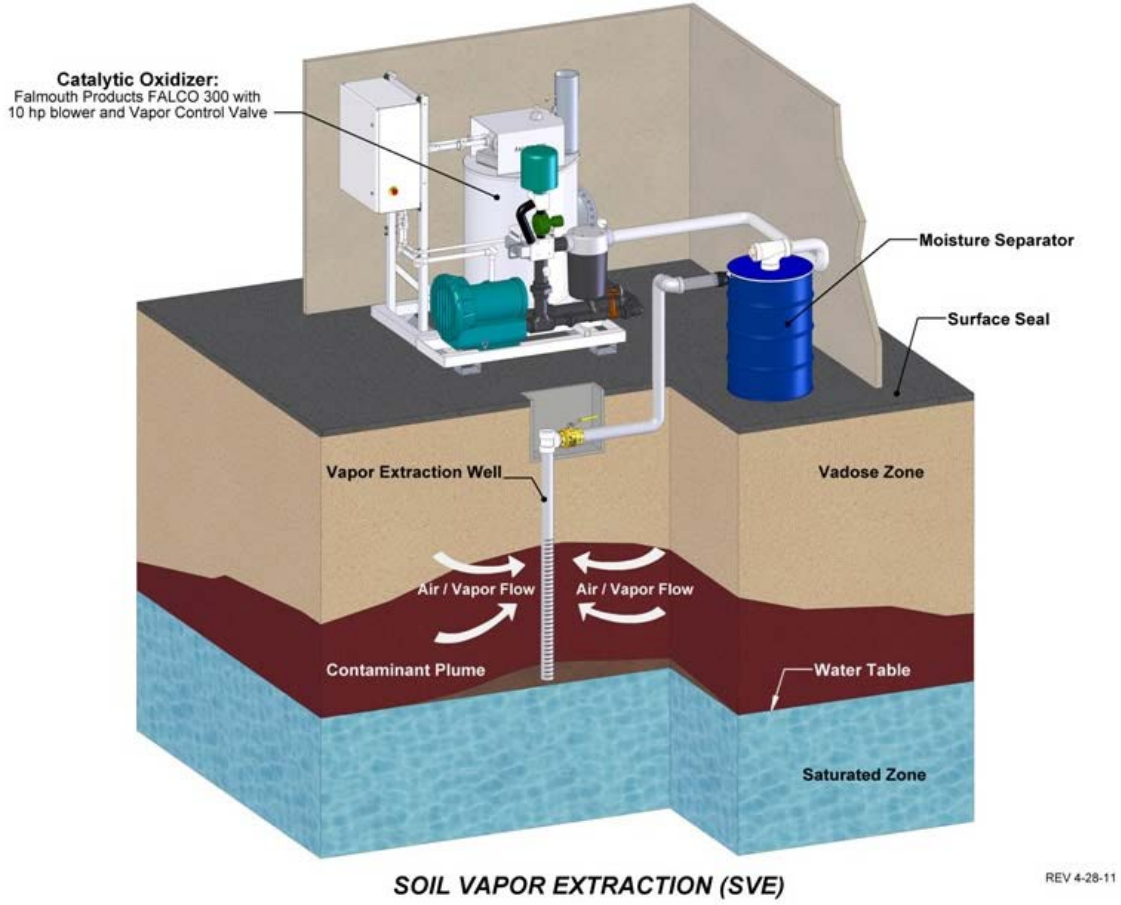

Şekil 1.1- SVE –Toprak Gazı Şeması.

1.3 TOPRAK GAZI EKSTRAKSİYONU (SVE) Uygulanması

Kirlenmiş bir alanın iyileştirilmesi için bir SVE sisteminin uygulanması, vakumlu üfleyicilerin/pompaların kullanılmasını, çıkarma kuyularının (dikey veya yatay) kurulmasını ve kirleticinin topraktan toprağa çıkarılmasından sorumlu olacak ilgili transfer borularının kullanılmasını gerektirir. Daha fazla tedavi için yüzey. Kirlenmiş hava akışının arıtılması, ulusal/bölgesel düzenlemeye uymak için emisyon arıtma hedeflerini gerçekleştirmek için tesislerin tasarımını/inşaatını/izinlerini ve uygun ekipmanı gerektirecektir. SVE işletimi ve bakımındaki deneyimler göz önüne alındığında, etkinliği genel olarak 1 ila 3 yıl aralığını göstermektedir [FRTR 2020].

2 TEKNİĞİN AÇIKLAMASI

2.1 Genel Proses Açıklaması

Toprak Gazı Ekstraksiyonu (SVE), doymamış bölgedeki kirlenmiş toprakların iyileştirilmesi için yerinde bir teknolojidir. Bu bölgeyi "havalandırarak" (veya bastırarak) uçucu kirleticilerin çıkarılmasına dayanır. Başarılı bir uygulama için ön koşul yeterli bir toprak geçirgenliğidir.

SVE, hava enjeksiyonu ile veya hava enjeksiyonu olmadan gerçekleştirilebilir. Aktif hava enjeksiyonu olmaması durumunda, taze hava atmosferden zemin yüzeyinden toprağın içine nüfuz eder. Hava sirkülasyonu, çeşitli fazlar (gaz, boşluk suyu, toprak parçacıkları) arasındaki kimyasal dengeyi değiştirerek katı ve/veya sıvı fazlardan uçucu kirleticilerin buharlaşmasını artırır. Çıkarılan buharlar, gaz çıkışı işlemine tabi tutulur.

Tüm süreç, tutarlı bir izleme sistemi tarafından kontrol edilmeli ve yönetilmelidir (örn. hava akış hızları, kirletici konsantrasyonu, sıcaklık, nem)

2.2 Sistem Tekniği ve Bileşenleri

Sahaya yerleştirilecek olan havalandırma sistemi aşağıdaki ana proses ekipmanlarından oluşmaktadır:

- kirlenmiş toprak tabakasına erişmek için dikey (veya yatay) çıkarma kuyuları ("çıkarma drenleri" olarak adlandırılır)
- İyileştirilecek alandaki hava akışını artırmak/kontrol etmek için dikey (veya yatay) enjeksiyon kuyuları (veya noktaları) ve özellikle sistemin tüm bileşenlerini ile saha sınır çizgilerinde bağlamak için valfler (ve akış hızı ölçerler)
- İyileştirilecek alandaki hava akışını artırmak/kontrol etmek için dikey (veya yatay) enjeksiyon kuyuları (veya noktaları) ve özellikle sistemin tüm bileşenlerini valfler (ve akış hızı ölçerler) ile saha sınır çizgilerinde bağlamak için
- İyileştirilecek alandaki hava akışını artırmak/kontrol etmek için dikey (veya yatay) enjeksiyon kuyuları (veya noktaları) ve özellikle sistemin tüm bileşenlerini valfler (ve akış hızı ölçerler) ile saha sınır çizgilerinde bağlamak için
- İyileştirilecek alandaki hava akışını artırmak/kontrol etmek için dikey (veya yatay) enjeksiyon kuyuları (veya noktaları) ve özellikle sistemin tüm bileşenlerini valfler (ve akış hızı ölçerler) ile saha sınır çizgilerinde bağlamak için
- Temizleme sistemini neme ve iletilen hava akımı tarafından harekete geçirilen yeraltı suyuna karşı korumak için bir yağışma ayırıcı veya buğu çözücü
- bir hava üfleyici blower/vakum ünitesi (ekstraksiyon kuyularına doğru toprak buharı akışını sağlamak için gerekli negatif basıncı oluşturmak için)
- bir çıkış gazı arıtma sistemi (çıkarılan toprak buharlarından kirleticileri çıkarmak için).

En yaygın arıtma mekanizmaları, aktif karbon üzerine adsorpsiyon ve katalitik veya termal oksidasyon yoluyla yok etmedir. Bir SVE sisteminin ve bileşenlerinin tipik bir şeması Şekil 2.1'de sunulmaktadır. Yanıcı maddeler (örneğin petrol) ilgili kirletici maddelerdir, bir sağlık ve güvenlik planı geliştirmek ve çıkış gazı arıtımında teknolojilerle ilgili kısıtlamaları dikkate almak çok önemlidir.

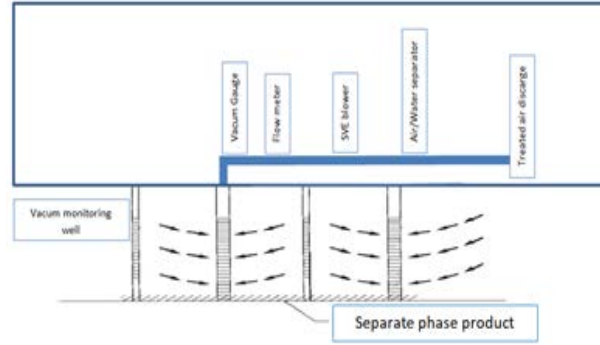

Şekil 2.1- Toprak Buharı/Gazı Ekstraksiyonu (SVE) Tesisinin Bşleşenleri

2.3 Kirleticilerin Arıtılabilirliği

SVE'nin etkinliği genellikle uçucu organik bileşikler (VOC'ler) için kanıtlanmıştır. Sahaya özel ve/veya diğer teknolojilerle kombinasyon halinde, yarı uçucu organik bileşikler (SVOC'ler) için uygulamalar da uygun olabilir. Genel olarak, kirleticilerin toprak katmanlarının katı fazına güçlü bir şekilde adsorbe edilmemesi de gereklidir.

Aromatikler için tipik uygulamalar (BTEX), Fenoller, Benzin, HC <12, Klorlu bileşikler (kloroform, VC, DCM, DCA, DCE, TCA, TCE, TC, PCE) ve Klorobenzenler (Düşük ikame ile). Bu nedenle SVE genellikle petrokimya sahalarında, benzin istasyonlarında, metal işleme ve metal işleme (yağ giderme ve kuru temizleme) atölyelerinde/endüstrisinde uygulanır.

SVE uygulamasında belirleyici faktörler, kirleticilerin özellikleri, özellikle fazlar arasındaki dağılım ve jeolojik saha düzeni, özellikle stratigrafi ve jeolojik katmanların geçirgenlik, gözeneklilik ve heterojenlik gibi özellikleridir.

Bazı kirlenici özellikler, sürecin verimliliği ve etkinliği için çok önemlidir. Bir bileşiğin buhar basıncı, o bileşiğin sıvısı (NAPL) ile dengede olan kısmi basıncıdır. Bu nedenle, L-V dengesinin (Liquid vapour equilibrium - Sıvı buhar Dengesi) bir ölçüsüdür. SVE, buhar basıncı > 0.5-1.0 mmHg olan maddeler için uygundur. Kaynama noktası buhar basıncı ile ilgilidir ve kaynama noktası 250-300°C'nin altında olan maddeler için uygun olan SVE'nin uygulanabilirliğini belirler. Henry sabiti, gaz halindeki belirli bir maddenin konsantrasyonunun ve sulu fazda aynı madde. SVE, Henry sabiti > 0.001 atm m³ / mol olan maddeler için uygundur.

2.4 Jeolojik Ortamın Dikkate Alınması

Jeoloji, toprak katmanlarının stratigrafisi ve toprak katmanı özellikleri, SVE uygulamasının etkinliği ve verimliliği için çok önemlidir. Bu nedenle tutarlı bir Kavramsal Alan Modeli geliştirmek için jeolojik saha düzenini anlamak çok önemlidir (bkz. bölüm 3.1).

Toprak özellikleri arasında temel parametreler gözeneklilik, geçirgenlik, (gözenek) su içeriği ve heterojenliktir. Toprak katmanlarındaki hava akışı, toprak içindeki birbirine bağlı gözenek boşlukları aracılığıyla gerçekleşir, bu nedenle daha fazla gözeneklilik, havanın topraktan akışını artırır. Gözeneklerde su bulunması hava akışını engelleyen fiziksel bir engeldir. Öte yandan, çok düşük nem içeriği, bazı kirleticilerin toprağa daha güçlü adsorpsiyonunu belirler.

Önemli ölçüde farklı doku ve geçirgenlik ile karakterize edilen alanların varlığı, hava akışını yönetebilir ve bu nedenle kısa kesintilere neden olan projeyi etkileyebilir (örn. homojen olmayan alanlarda veya emme şaftının yakınında tercih edilen hava akışları). Hava akışını sınırlayabilecek bir diğer önemli faktör de yeraltı suyu seviyesidir. Ekstraksiyon kuyularında indüklenen çöküntü, piyezometrik seviyede bir artışa neden olabilir (0.2 atm'lik bir çöküntü yaklaşık 2m'lik bir yükselmeye neden olur) ve kısmen kuyuları ve SVE sistemini taşar. Yaklaşık 3 m'lik bir yeraltı suyu tablası derinliği için uygun koşullar varsayılabilir, aksine 1.5 m'den daha az derinlikler tavsiye edilmez.

Ayrıca topraktaki (örneğin turba/torf) daha yüksek toprak organik karbonu (SOC) içeriği de SVE'yi engelleyebilir. (SOC desorpsiyonu ve uçuculuğu ile ilgili olarak giderek daha sınırlı hale gelir ve benzer geçirgenlik de önemli ölçüde azalacaktır, ancak bu net değildir).

Aşağıda özetlenen parametreler, başarılı bir projenin anahtar bileşenleri olabilir:

- Jeolojik katmanların yüksek geçirgenliği;
- homojen toprak bileşimi, yani farklı dokuya sahip katmanların ve mercceklerin olmaması, yeraltı altyapısının varlığından kaynaklanan tercihli hava akışı yollarının olmaması;
- organik kirleticiler için yüksek absorpsiyon kapasitesine sahip lenslerin veya turba tabakalarının olmaması;
- kısıtlandırılmış kirletici havuzların olmaması;
- nispeten düşük geçirgen tabakaların geçirimsiz kaplamasının olmayışı;
- sığ yeraltı suyunun olmayışı

2.5 Sistemi Tasarlamak İçin Hususlar

SVE sisteminin tasarımı aşağıdaki tanımlardan oluşmaktadır:

a) Sistem İşletim Parametreleri:

- Hava tahliye Hızı
- Ekstraksiyon kuyusundaki vakum derecesi
- Etki Yarıçapı (ROI)

b) Sistem Bileşenleri:

- Ekstraksiyon Kuyularının Sayıları ve Lokasyonları
- Kuyuların İnşaatı/teşkili
- Ekstraksiyon Fanı/ Emiş Fanı
- Su-Hava Sıyırıcı
- Isı Eşanjörlü Buhar İşleme Ünitesi

SVE'nin tasarımı için sahada pilot testler yapılır. Bu testler, ulaşılan vakumun ölçüldüğü en az 1 ekstraksiyon kuyusu ve en az 3 izleme noktası (saha heterojenliği durumunda muhtemelen çok seviyeli) içermelidir. Yararlı bir pilot test için, her şeyden önce, emme kanalında normalde sağlanan regülasyon/düzenleyici valfi üzerinde

hareket ederek ekstraksiyon akışını ayarlamak gerekir. Her valf konumu için (belirli bir akış hızına karşılık gelir), sistem stabilizasyonu için yaklaşık 30 dakika beklenerek ve aşağıdakiler ölçülür:

- Ekstraksiyon kuyusundaki vakum derecesi;
- İzleme noktalarında indüklenen vakum derecesi;
- Tahliye edilen/çıkarılan havanın akış hızı;
- Çıkarılan gazın bileşimi ve sıcaklığı.

Ölçümler, farklı derecelerde valf açıklığı için tekrarlanır. Zeminin/toprağın içsel geçirgenliği (k), pilot test sırasında toplanan ölçümlerle tahmin edilebilir.

En önemli tasarım kriterlerinden biri, pilot test sırasında toplanan ölçümlere dayanan etki yarıçapıdır. Sonuçlandırılmış vakalara dayalı bir veri tabanının olmaması durumunda, tam ölçekli bir müdahale tasarlamak için en güvenilir yöntemdir.

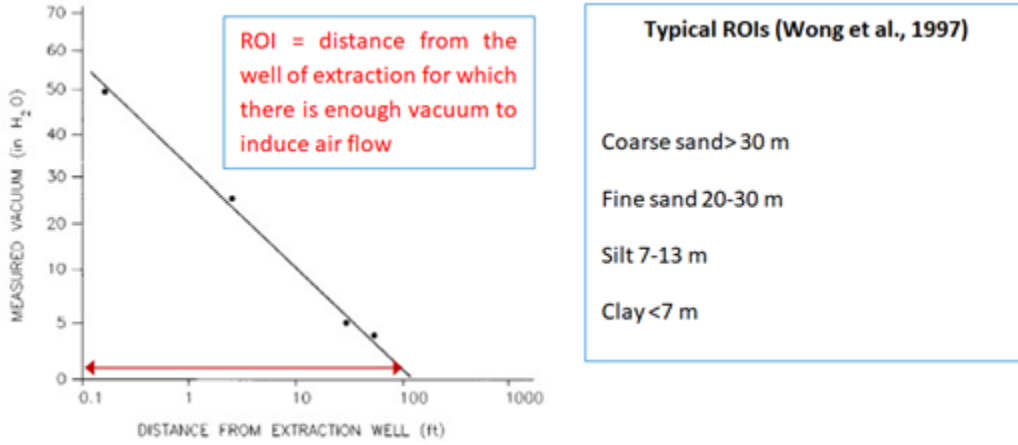

Şekil 2.4- Etki Yarıçapı

Etki yarıçapı tanımlandıktan sonra, yeterince tedavi edilmeyen/giderim sağlanmamış/iyileştirilmemiş alanlardan kaçınmak için kısmi bir örtüşme sağlayan, etki yarıçapına eşit bir yarıçapa sahip bir dizi daire çizilir.

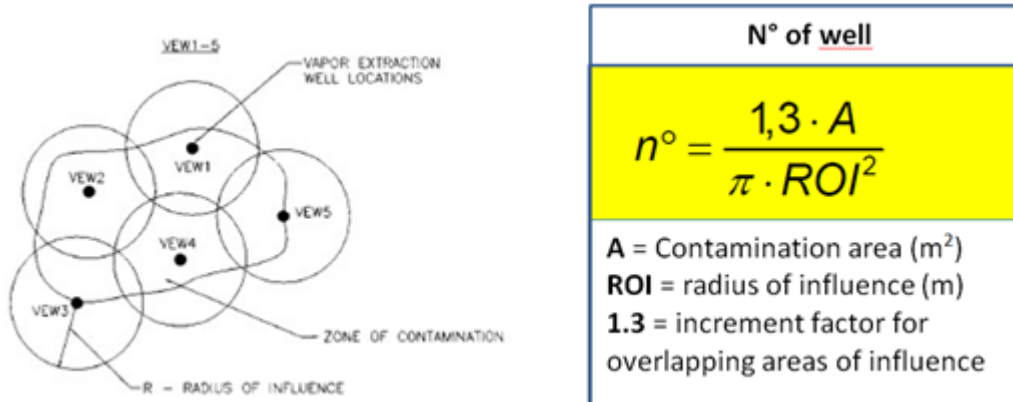

Şekil 2.5- Kuyu Sayısı

Pencerenin/ filtre için gözeneklerin derinliği tanımlandıktan sonra (genellikle kirlenmenin derinliğine eşittir) ve vakumla bağlantılı etki yarıçapı bilindiğinde, hava çıkarma hızlarını belirlemek mümkündür.

EXTRACTION RATES

$$\frac{Q}{H} = \pi \frac{k}{\mu} P_w \left[\frac{1 - \left(\frac{P_{atm}}{P_w}\right)^2}{\ln\left(\frac{R_w}{R_i}\right)} \right]$$

H = fenestration length (m)
k = intrinsic permeability (cm²)
P_w = well pressure (g / cm / s²)
P_{atm} = pressure atm (g / cm / s²)
R_w = well radius SVE (cm)
R_i = radius of influence (cm)
Q = well air flow (cm³ / s)

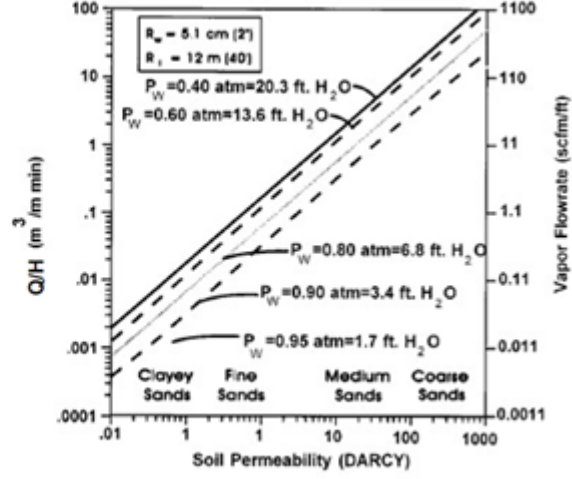

Şekil 2.6 Ekstraksiyon Oranları

Pilot çalışmalardan ve uygulamalardan elde edilen ekstraksiyon hızı için tipik tasarım değerleri 20-200 m³/saat; pilot çalışmalardan ve uygulamalardan kuyu başı çökmesi için tipik tasarım değerleri 0.5-1 atm'dir.

Çıkarılan buharlar, konsantrasyonlara bağlı olarak farklı işlemlere tabi tutulur. Yanıcı maddelerin endişe konusu kirleticiler olarak ilgili olması açısından en önemli parametre Alt patlama sınırındır (LEL). C (vap) < %25 LEL ise aktif karbon uygulanabilir ve katalitik oksidasyon uygulanabilir; C (vap) < %25-50 LEL ise termal oksidasyon önerilir; C (Vap) < %10 LEL ise biyofiltre uygulanabilir

3 FİZİBİLİTE ÇALIŞMASI

Bu teknolojiyi seçmek için birincil kriterler, gözenekli ortamın hava geçirgenliği ve kirleticilerin uçuculuğudur. Teknoloji daha sonra sahaya özgü çeşitli faktörler göz önünde bulundurularak daha fazla taranmalıdır.

3.1 Saha Koşulları ve Kavramsal Saha Modeli

Çok sayıda saha fiziksel ve kimyasal koşulu, iyileştirici bir alternatif olarak SVE'nin etkinliği üzerinde önemli bir etkiye sahiptir. Bu parametreler, toplanması gereken Toprak Gazı Ekstraksiyonu Yöntemi (SVE) fizibilitesi ve tasarımı ile ilgili saha karakterizasyon verileriyle birlikte aşağıdaki bölümlerde tartışılmaktadır.

Şekil 3.1, bu site karakterizasyon verilerini özetlemektedir. İlgili verileri mümkün olduğunca erken toplamanın önemi fazla vurgulanamaz. Bir kişinin siteyi anlaması asla mükemmel olmayacaksa da (çünkü karakterizasyon araçları, finansal kaynaklar ve örnekleme yöntemleri pratik sınırlamalara sahiptir), sitenin tutarlı bir resmine doğru yaklaşan kanıt dizilerini bir araya getirme ve belgeleme yükümlülüğü vardır. Sitenin bu resmi veya kavramsal modeli, çeşitli veri türlerini içermesi bakımından zorunlu olarak çok yönlü ve çok disiplinlidir. Ayrıca dinamiktir, ek veriler elde edildikçe gelişir. Yeni saha çalışmaları yeni bilgiler sağladığından, site kavramsal modelini sürekli olarak yeniden formüle etmek önemlidir.

Saha Kavramsal Modeli, bir (hidro)jeolojik saha tanımından başlamalı ve kirliliğin birincil kaynağını/kaynaklarını, salınan kütleyi, salınım modelini ve özellikle vadoz bölgesindeki kirletici dağılımının dikey ve yatay boyutunu karakterize etmelidir. Toprak gazı/buharı ekstraksiyonu için vadoz bölgesi karakterizasyonunun bir dizi kilit yönü vardır. Kısaca bunlar şunları içerir:

- yüzey örtüsünün tipi (e.g., asfalt, nebati toprak, bitki);
- gömülü yapıların veya tesislerin mevcudiyeti ve kapsamı
- topoğrafya
- toprak tipi dağılımı ve derinliği
- su tablasına olan derinlik ve suyun seviyesinin mevsimsel dalgalanması
- toprak nem içeriği ve değişkenliği
- kılcal saçak kalınlığı
- hava geçirgenliği ve ilgi alanı içerisinde nasıl değiştiği
- organik karbon içeriği ve çeşitliliği

Bu kilit site öğelerinin herhangi biri (veya bir kombinasyonu) SVE etkinliğini güçlü bir şekilde etkileyebilir ve/veya Toprak Gazı Ekstraksiyonu (SVE) için ciddi bir sınırlama oluşturabilir. Çoğu zaman, SVE teknolojilerinin uygulanması için potansiyel olarak önemli olan saha karakterizasyon verileri toplanmaz çünkü toprak sondajlarının ve gözlem çukurlarının günlüğe kaydedilmesinden sorumlu olanlar ya bunların farkında değildirler ya da bunları tanımları ve sistematik olarak kaydetmeleri istenmemektedir.

Yüzey horizonlarının doğasını anlamak çok önemlidir. Daha ince dokulu bir matristeki kumlu veya çakıllı mercerler veya tercihli hava akışı yolları olarak hizmet edebilecek makro gözenekler gibi yüzey altı özelliklerinin belirtileri kaydedilmelidir. Toprak renkleri ve benekler, su tablasının mevsimsel olarak dalgalandığı bölgenin bir göstergesi olabilir. Kentsel veya endüstriyel yerlerde, mümkünse bozulmuş toprak/dolgu ile doğal toprak arasındaki temas fark edilmelidir. Standart toprak karakterizasyon yöntemleri, bu amaçlar için, kullanımları konusunda eğitim almış kişiler tarafından kullanılmalıdır (Breckenridge, Williams ve Keck 1991; USEPA 1991h).

Parameter	Collection Method	Analytical Method
Air-phase permeability (field-scale)	Pneumatic pump test	See Cho and DiGiulio (1992)
Air-phase permeability (core-scale)	In situ or undisturbed 50- to 75-mm diameter soil sample typical	See paragraph 4-2d and Appendix D; Corey (1986a)
Stratigraphy/heterogeneity	Soil boring and/or test pit	Visual observation; Breckenridge, Williams, and Keck (1991); USEPA (1991h)
Grain size	Split spoon or other soil sample	ASTM D422-63 (1998)
Porosity	Undisturbed 50- to 75-mm-diameter soil sample	Calculated from dry bulk density and particle density
Dry bulk density	Undisturbed 50- to 75-mm-diameter soil sample	ASTM D2850
Organic carbon content	Split spoon sample	SW-846 9060; Churcher and Dickhout (1989)
Moisture content (saturation)	Neutron logging via access tubes Tensiometers Undisturbed 50- to 75-mm diameter soil sample	Neutron gauge (Gardner 1986), ASTM D3017, ASTM D5220 Cassel and Klute (1986) ASTM D2216-92
Soil moisture retention (Capillary pressure saturation curve)	Undisturbed 50- to 75-mm diameter soil sample	Klute (1986); ASTM D2325-93
Dry end soil moisture retention	Undisturbed 50- to 75-mm diameter soil sample	Psychrometer Method (Jones, Gee, and Heller 1980)
Soil Temperature	Thermometer, Thermocouple	Portable Meter
Depth to groundwater and seasonal variations	Water table monitoring wells, Water level meter or interface gauge and surveyed well elevations	ASTM D4750
Volatile hydrocarbon content in soil gas	In situ	Downey and Hall (1994); ASTM D3416-78
O ₂ content in soil gas	In situ	Portable meter, electrochemical cell method
CO ₂ content in soil gas	In situ	Portable meter, infrared adsorption method
Microbial respiration rate	In situ	Hinchee et al. 1992

Şekil 3.1- Test ve Analitik Yöntemlerin Özeti

3.1.1 Kirlenmenin Doğası ve Kapsamı

Saha karakterizasyonu sırasında, SVE'nin uygulanabilirliğini değerlendirmek için saha ortamının kimyasal özellikleri ve kontaminasyonun doğası ve kapsamı belirlenmelidir. SVE'ye en uygun kirleticiler, benzin, kerosen, birçok dizel yakıt bileşeni, freon ve PCE, trikloroeten ve metilen klorür gibi çözücüleri içeren VOC'lerdir.

Aşağıdaki şekil, çeşitli kirlenme grupları sunmakta ve SVE'ye uygunluklarını derecelendirmektedir.

Contaminant Groups		Example of Contaminants	Effectiveness
Organics	Halogenated VOCs	Tetrachloroethene, Trichloroethene	a
	Halogenated SVOCs*	Para-dichlorobenzene	b
	Nonhalogenated VOCs	Gasoline	a
	Nonhalogenated SVOCs*	Diesel fuel	a
	PCBs	Aroclor - 1242	c
	Pesticides	Chlordane	c
	Dioxins/furans	2,3,7,8-Tetrachlorodibenzo-p-dioxin	c
	Organic cyanides		c
	Organic corrosives		c
	Explosives	2,4,6 Trinitrotoluene	c
Inorganics	Volatile metals	Mercury, tetraethyl lead	c
	Nonvolatile metals	Nickel, chromium	c
	Asbestos		c
	Radioactive materials		c
	Inorganic corrosives		c
	Inorganic cyanides	Sodium cyanide	c
Reactive	Oxidizers		c
	Reducers		b

Figure 3.2- SVE'nin Kirlenici gruplar üzerindeki etkinliđi

3.1.2 Kaynađın Geometrik Karakteristiđi

- Uygun teknolojilerin taranması için projenin saha karakterizasyonu aşamasında kontaminasyonun boyutu üç boyutta belirlenmelidir. SVE ile ilgili olarak, doymamış bölge ve doymuş bölge karakterize edilmelidir.
- Kirlenme derinliđi, SVE sistemlerinin fizibilitesini ve tasarımı etkiler. Kirlenme zemin yüzeyi ile sınırlıysa, SVE dışındaki teknolojiler tercih edilecektir. Kirlenme, doymuş bölgede derinlikte bulunuyorsa, tek başına SVE mümkün olmayacaktır. SVE'nin uygulanabilir olduđu yerlerde, kontaminasyon derinliđi kuyu tipini (yatay ve dikey), taranan kuyu aralıđını ve diđer tasarım faktörlerini etkileyecektir.
- Kirlenmiş toprađın hacmi, SVE'nin uygulanabilirliđini etkiler. Hacim küçükse, kazı ve saha dışında bertaraf gibi diđer alternatifler daha uygun maliyetli olabilir. Kirlenmiş toprađın hacmi, kuyu sayısı, bloerların/hava üfleyicilerin boyutu ve atık gaz arıtma sistemi kapasitesi gibi sistem tasarımının birçok yönünü de etkiler.
- SVE sistemlerinin fizibilitesi ve tasarımı belirlenirken, potansiyel tesis dışı buhar fazı kirlenici kaynakları göz önünde bulundurulmalıdır. SVE sırasında önemli buhar fazı kontaminasyonu saha dışı kaynaklardan sahaya geçebilirse, sistem tasarımının hava enjeksiyon kuyularını veya bu oluşumu önlemenin başka yollarını içermesi gerekecektir.

3.1.3 Suyla Karışmayan Sıvı Tehlikeli Kimyasal Maddelerin (NAPL)'nin Mevcudiyeti

Saha araştırmacısı, NAPL'nin mevcut olup olmadığını belirlemelidir. Yeraltı suyu numunelerindeki serbest ürün, NAPL'nin bir göstergesi olacaktır. NAPL, doymamış bölge içindeki gözenek alanı için hava ve toprak nemi ile rekabet ederek hava fazı geçirgenliğini azaltır. Ek olarak, NAPL sürekli bir kirlenici kaynağı sağlar. Mevcut gözenek alanının yüzde 15 ila 50'si arasında doymamış bölge artık doygunlukları rapor edilmiştir (USEPA 1989c).

Yoğunluğu Sudan Fazla Suyla Karışmayan Sıvı Tehlikeli Kimyasal Madde (DNAPL)'nin varlığından şüpheleniliyorsa, DNAPL'nin daha derin hidrolojik birimlere göç etme riskini azaltmak yerine SVE'nin uygulanmasının artabileceğine dair endişeler olabilir. Örneğin, DNAPL su tablasının üzerindeki kırık anakayada bulunuyorsa bu durum söz konusu olabilir. Böyle bir ortamda bir ekstraksiyon kuyusuna doğru hava akışının indüklenmesine, DNAPL'nin kırılma sisteminin daha derinlerine ve belki de doymuş bölgeye doğru bir karşı akışının eşlik edebileceği teorize edilmiştir. Böyle bir durumda Teknik Uygulanamazlık feragati uygulanabilir (USEPA 1993g).

3.1.4 Toprak Gazı Araştırması Sonucu

Doğaları gereği, SVE'ye uygun kirleniciler, toprak gazı araştırmaları sırasında ölçülebilir. Sıklıkla, sahadaki toprak gazı ölçümü, bir sahadaki toprak kirliliğinin doğasını ve kapsamını karakterize etmenin yararlı bir yoludur. Sınırlı sayıda laboratuvar analizi ile teyit edilen toprak gazı kirlenici konsantrasyonlarının saha ölçümleri, saha karakterizasyonu için genellikle yeterlidir. Bununla birlikte, toprak gazı ve toprak konsantrasyonları arasında iyi bir nicel korelasyon nadiren elde edilebilir. Bu, özellikle kalıntı NAPL nedeniyle daha yüksek kirlenici konsantrasyonları mevcut olduğunda geçerlidir. Toprak gazı ve toprak numunesi konsantrasyonlarını karşılaştırırken, toprak numunesi sonuçlarının tüm toprak kompartımanlarındaki kirlenicileri temsil ettiğini ve toprak gazının sadece buhardakileri ölçtüğünü akılda tutmak faydalı olacaktır. Toprak gazı araştırmaları, başlangıçta SVE atık gazında beklenebilecek kirlenici konsantrasyonlarının bir göstergesini de sağlayabilir.

3.1.5 Hava Geçirgenliği

Hava geçirgenliği, toprağın hava geçişine izin verme yeteneği, SVE fizibilitesini ve tasarımını etkileyen en kritik parametrelerden biridir. Katı matris özelliklerinin ve nem içeriğinin bir fonksiyonudur. Hava geçirgenliği, hava akış hızları ve kirlenici geri kazanım oranları üzerinde derin bir etkiye sahiptir. İri taneli topraklar tipik olarak büyük hava geçirgenliği değerleri ve daha düzgün hava akışı modelleri sergiler. Hava geçirgenliği yaklaşık 10-10 cm²'den az olan topraklar SVE'ye uygun olmayabilir (USEPA 1993d).

3.1.6 Heterojenlikler ve Tercihli Ulaşım Yolları

Heterojenlikler, doymamış bölge içindeki kirlenicilerin dağılımında önemli bir rol oynar ve toprak tipi, tabakalaşma, gözeneklilik ve nem içeriğindeki uzaysal değişikliklerden kaynaklanır. Bir SVE sisteminin çalışması sırasında, bu değişiklikler hava akışı modellerini ve nihayetinde doymamış bölge içindeki kirlenici geri kazanım oranlarını etkileyebilir. Örneğin, doymamış bölge, birbirini izleyen iri ve ince daneli toprak katmanlarından oluşuyorsa, hava akışı iri daneli katmanlarla sınırlanabilir. Kirleniciler genellikle çok daha yavaş oranlarda daha ince taneli tabakalardan uzaklaştırılır. Zemin sondajları, koni penetrometrisi ve test çukurlarının maruz kalan yüzlerinin zemin profile incelemeleri, fiziksel heterojenlikler hakkında bilgi edinme yöntemleri arasındadır.

Bazı durumlarda, fırtına ve sıhhi kanalizasyon gibi yeraltı kamu hizmetleri veya bu özelliklerle ilişkili dolgu malzemesi, bir SVE sistemiyle bağlantılı hava akımında kısa devre oluşturabilir. Sonuç olarak, hava akımı, tedavi gerektiren bölge içinde değil, bu özellikler boyunca yoğunlaşabilir. Ek olarak, bu özellikler doymamış bölge içindeki hem serbest fazlı sıvılar hem de buharlar için göç yolları sağlayabilir. Sonuç olarak, bu özelliklerin yönelimi ve geometrisi, sıvıların veya buharların göç ettiği yönü belirleyebilir. Çoğu zaman, yeraltı tesislerinin doğru şekilde yapılmış çizimleri mevcut değildir, bu nedenle sahaya aşına olan kişilere de danışılmalıdır. Yakındaki binaların bodrumları ve akışı etkileyebilecek diğer özellikler not edilmelidir.

3.1.7 Topoğrafya

Topoğrafya ve zeminin doğası SVE'yi etkilemektedir. Geçirimsiz bir yüzey, yatay hava akışını artırma ve etki yarıçapını artırma eğiliminde olacaktır. Geçirgen bir yüzey bunun tersini yapacak ve yeraltına giren atmosferik hava miktarını arttıracaktır. Binalar, yollar ve altyapı sistemleri gibi yüzey kısıtlamaları, SVE'yi diğer seçeneklere göre çekici bir iyileştirici alternatif haline getirebilir. Zemin yüzeyinde kaplama varsa, bütünlüğü incelenmelidir. Çatlaklar not edilmeli ve mümkünse kapatılmalıdır.

3.2 SVE İyileştirme Tasarımında Sınama-Ölçek Testinin Kullanımları

Tasarım parametrelerini belirlemek için sütun testleri kullanılmaktadır. Ball ve Wolf (1990), küçük alanlarda homojen izotropik topraklarda tek kirleticilere yönelik SVE sistemleri için tasarım parametrelerinin belirlenmesi için laboratuvarında kolon testleri önermektedir. Yaklaşımları, bir kolonu saha toprağı ile doldurmak, temsili bir hava akımı uygulamak ve gözenek hacmi değişimlerinin sayısının bir fonksiyonu olarak atık kirletici konsantrasyonlarını ölçmektir. Daha sonra üstel bir bozunma denklemi bu verilere uyarlanır ve kalibrasyon parametresi, tam ölçekli SVE sistemi için emisyon oranının büyütülmüş bir tahmininde kullanılır. Bu bilgi ile toplam toprak iyileştirme süresi ve maliyeti tahmin edilebilir.

SVE etkinliğini belirlemek için sütun testleri kullanılmaktadır. USEPA (1991c), SVE'nin bir sahada etkili olup olmayacağına dair bir soru olduğunda, sütun testleri önermektedir. Hedef bileşiklerin buhar basıncı 10 mm Hg veya daha fazla olduğunda bu adım atlanabilir. Kolon/sütun testleri, ana kayası kırık veya büyük moloz parçalarından oluşan heterojen dolgulu sahalar için de uygun değildir.

Bu çalışmaların maliyeti nispeten düşüktür ve kolondan yaklaşık 2.000 gözenekli hava hacminin geçirilmesini içerir (yaklaşık 6 günlük çalışma sırasında). Bu eşdeğerliğin, geçirgenlik ve nem içeriği gibi toprak koşullarına bağlı olduğuna dikkat edilmelidir. Örneğin, kuru, kumlu bir toprakta 2.000 gözenekli hacim bir yıl gibi kısa bir sürede çıkarılabilirken, nemli, siltli bir kil 6 yıldan fazla gerektirebilir. Ancak çoğu durumda, sahaya özgü akış senaryoları 3 ila 6 yıllık aralığa denk gelir. Kolon testlerinin yapılmasının nedeni, zeminin difüzyon kinetiğini incelemektir. İlk 1000 gözenekli hacimde kirletici madde salınımının neredeyse her zaman difüzyonla sınırlı hale geldiği ve bu da dengeye nispeten hızlı bir şekilde ulaşıldığını gösterir. 2.000 gözenekli hacimli bir çalışma periyodu bu nedenle difüzyon kinetiğinin nicelleştirilmesine izin verir.

Test sırasında toprak gazı kirletici konsantrasyonları izlenir ve yüzde 80 veya daha fazla bir azalma, SVE'nin saha için potansiyel olarak uygun olduğunu ve ek kolon çalışmaları ile daha fazla değerlendirilmesi gerektiğini gösterir. Yüzde 95'ten daha fazla azalma elde edilirse, kolondaki kalıntı toprak, kalıntı kontaminasyonu ölçmek için analiz edilebilir. Konsantrasyonlar temizleme hedeflerinin altındaysa, ilaç seçimi için sütun testleri atlanabilir ve daha sonra hava geçirgenlik testleri yapılabilir.

Sütun testleri çoğu SVE uygulaması için gerekli değildir, ancak belirli koşullar altında, örneğin yenideninatif (bozunması zor) kirleticilerin havalandırılması ve/veya biyolojik olarak bozunması gibi durumlarda faydalı olabilir. Kolon testleri tipik olarak 2 ila 8 kg kirlenmiş toprak (örneğin, 5 ila 10 cm çapında ve 30 ila 60 cm uzunluğunda kolon boyutlarına sahip) kullanır ve sonuçlar asimptotik hale gelene kadar, toprak özelliklerine ve toprak özelliklerine bağlı olarak süre ve maliyetle birlikte yürütülür. Kirleticiler, kolon testlerinden önce alınan ölçümler, yığın yoğunluğu, nem içeriği ve toprak matrisindeki, sızıntı suyundaki ve üst boşluktaki kirletici konsantrasyonlarının analizlerini içerebilir. Kirletici çıkarma oranlarının hava akışına duyarlılığını kontrol etmek için farklı hava akış hızları test edilebilir. Test sırasında alınan ölçümler, içeri giren ve çıkan hava basınçlarını, atık kirletici madde konsantrasyonlarını, hava akış oranlarını ve sıcaklığı içerir. Testten sonra, temizleme hedefleriyle karşılaştırma için toprak matrisindeki ve Toksikite Karakteristik Yıkama Prosedürü (TCLP) sızıntı suyundaki kirletici konsantrasyonları ölçülür. Şekil 3.3'te bir kolon test cihazının bir taslağı gösterilmektedir.

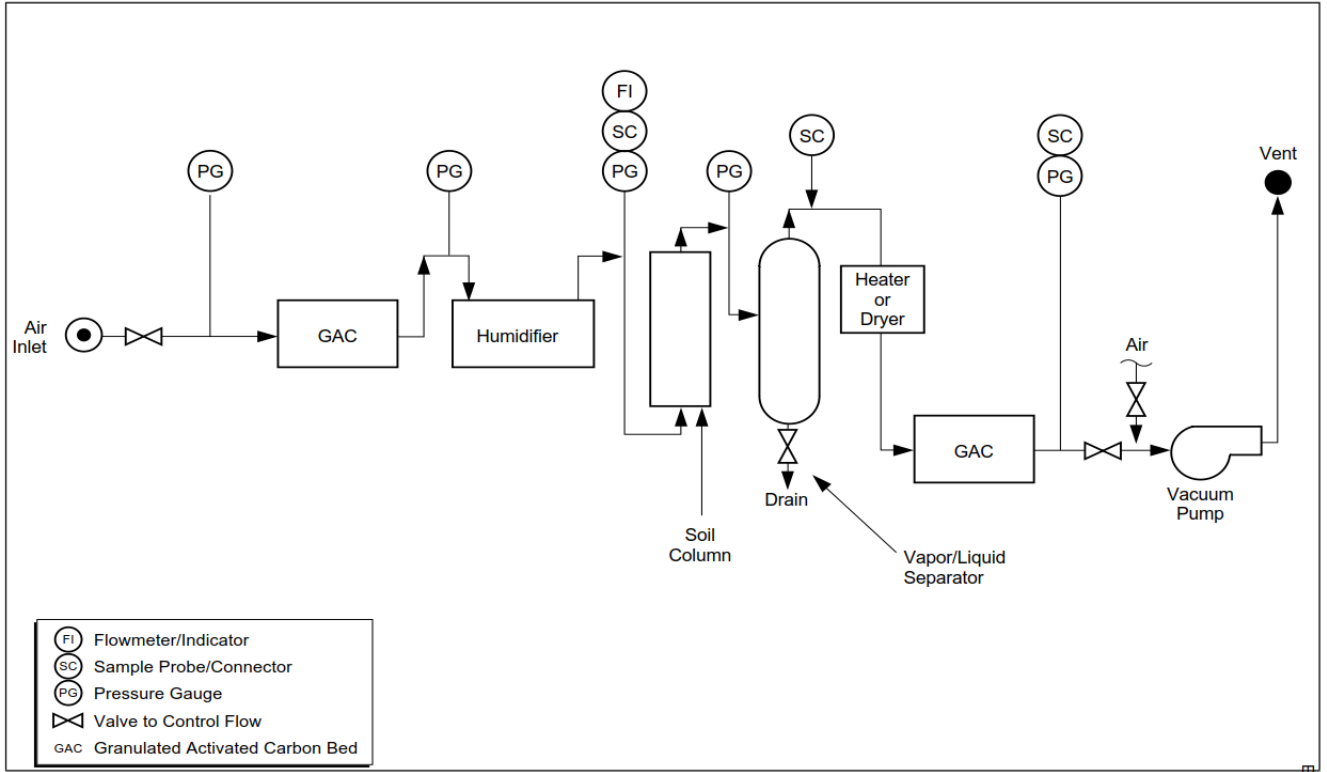

Şekil 3.3- Bir Kolon test Cihazının Şeması

Şekil 3.4, kolon testlerinin avantajlarını ve dezavantajlarını sunar. Kolon testleri genellikle hava geçirgenlik verilerinin tek kaynağı olarak güvenilmemekle birlikte, yerinde hava geçirgenlik testlerini desteklemek için yararlı bir araç sağlayabilirler.

Örneğin, yerinde testler genellikle yalnızca sınırlı sayıda lokasyonda gerçekleştirilebilirken, bozulmamış maçalar, in situ ka test lokasyonları dahil olmak üzere birçok lokasyon ve derinlikten toplanabilir, böylece laboratuvar ve in situ arasındaki korelasyon veriler incelenebilir. Sonuçlar iyi bir şekilde ilişkilendirilirse, laboratuvar verileri, örnekleme alanı boyunca yerinde sonuçları genelleştirmek için kullanılabilir.

Advantages	Limitations
1. May accelerate the SVE process to permit evaluation of maximum contaminant removal potential.	1. Stripping air always has good access to the contaminants throughout the column. Airflow to different zones varies widely in the field.
2. Gives order-of-magnitude information on the partition coefficients needed for mathematical modeling.	2. Diffusion processes are often not properly modeled.
3. Order-of-magnitude air permeability measurements may be obtained with "undisturbed" samples.	3. Due to the differences in scale and airflow vs. core orientation, more representative air permeability results must be obtained through field air permeability measurements.
4. Can permit analysis of closely spaced samples.	4. Standard procedures must be formulated and validated.

Şekil 3.4- Sütun/kolon testi avantajları ve sınırlamaları

Kolon testleri en iyi şekilde sağlam çekirdek numuneleri kullanılarak gerçekleştirilir. Sağlam karot numuneleri, sürücü numune alıcıları veya sürekli karot alma cihazları kullanılarak elde edilebilir. Karot numuneleri sert kılıflar içinde toplanmalı ve numune tanımlaması ve yönü ile açıklanmalı olmalıdır. Numuneler, kirletici maddelerin buharlaşmasını ve bozulmasını önlemek için toplandıktan sonra mühürlenmeli ve soğutulmalıdır. Tipik sondaj prosedürleri, zemin çekirdeklerini dikey veya dikeye yakın bir oryantasyonda kırtarır. SVE sırasındaki tipik hava akışı, kesinlikle üç boyutlu olsa da, dikey değildir ve yatay hava geçirgenliği muhtemelen daha fazla ilgi çekicidir. Bu gerçek, test için dikey çekirdeklerin toplanıp toplanmayacağına karar verirken dikkatlice tartılmalıdır.

Laboratuvarda, karot numuneleri test kolonlarına ekstrüde edilebilir veya numune manşonları kolon kurulumuna dahil edilebilir. Bozulmuş numuneler alındıysa, numuneler saha koşullarına yaklaşan bir nihai yoğunluğa yeniden paketlenmelidir. Test, katmanlı bir profilden dikey akışı simüle etmek için tasarlanmışsa, zeminin yerleştirilmesi sırasında katmanlar dahil edilebilir. Testin yatay hava akışını simüle etmesi amaçlanıyorsa, bozulmamış, yatay olarak yönlendirilmiş maçaların toplanması düşünülmelidir.

Test ekipmanı tipik olarak bir vakum veya hava besleme sistemi, akış ölçüm cihazları ve basınç ölçüm ekipmanı içerir. Toprak nemi ölçüm cihazları (örneğin tansiyometreler) de sağlanabilir. Hava besleme sistemi, kolon duvarları ve zemin numunesi arasındaki tüm bağlantılar hava geçirmez olmalıdır. Bazı kolonlar, toprak numunesinin kenarları boyunca sızıntıyı önlemek için çekirdek numune ile kolon duvarı arasındaki halkada şişirilebilir bir balon içerir. Kirletici konsantrasyonları katı veya buhar fazında ölçülebilir. Toprak ölçümleri yıkıcı örnekleme gerektirdiğinden, ölçüm noktaları başlangıç ve son konsantrasyonlarla sınırlıdır. Buhar örnekleme, atık konsantrasyonlarının zaman serisi ölçümüne izin verir, ancak tipik olarak karmaşık yerinde ölçüm ekipmanı (örneğin gaz kromatografarı) gerektirir. Buhar ölçümleri, ilk ve son toprak konsantrasyonları ile desteklenmelidir.

Test sonuçları genellikle değiştirilen havanın toplam hacmine karşı kirletici konsantrasyonu olarak ifade edilir. Kolon testlerini saha uygulamalarıyla ilişkilendirmek için hava değişimi tipik olarak gözenek hacmi birimlerinde ifade edilir.

Gözenek hacimlerinin hesaplanması, numune gözenekliliği ve boyutlarının yanı sıra akış hızı ve geçen sürenin ölçülmesini gerektirir. Sonuçlar, kirletici uzaklaştırma oranını ve tahmini kalıntı konsantrasyonlarını değerlendirmek için kullanılabilir. Denge konsantrasyonlarının odak ile birlikte her fazda eş zamanlı olarak ölçülmesi koşuluyla, bölme katsayıları da belirlenebilir.

3.3 SVE Fizibilite Değerlendirmesi

- Henry Yasası sabitleri düşük olan kirleticilerin SVE yoluyla arıtılması zordur. Belirli koşullar altında, sıcak hava, buhar enjeksiyonu veya diğer yüzey altı ısıtma teknolojileri yoluyla uçuculuğu iyileştirmek için SVE'deki termal iyileştirmeler düşünülebilir.
- SVE, doymuş bölgede etkili değildir ve su tablası yüksekliğindeki mevsimsel değişiklikleri hesaba katmak için çıkarma kuyusu ekranları konumlandırılmalıdır. Bazı tesislerde, su tablasının pompalama yoluyla düşürülmesi, SVE yoluyla daha fazla ortamı arıtmaya maruz bırakmak için düşünülebilir.
- Sistem, hedef aralığın tüm bölümlerinden buharın etkin bir şekilde uzaklaştırılmasını sağlamak için tasarlanırken jeolojik çerçeve ve yanal ve dikey heterojenlik derecesi dikkate alınmalıdır. Örneğin, bir silt veya kil merceği ile karşılaştırıldığında, kumlu bir aralıkta akışı indüklemek daha kolaydır. Ayrıca, bir kuyu bunu hesaba katacak şekilde taranmazsa, bir kil tabakası kirlenmiş aralığın bölümlerinde buhar çıkarılmasını engelleyebilir.
- Yüksek oranda ince taneli ve yüksek derecede su doygunluğuna sahip topraklar, daha yüksek vakumlar gerektirecek, maliyetleri artıracak ve/veya arıtmanın etkinliğini ve homojenliğini engelleyecektir.
- Çok değişken geçirgenliğe veya tabakalaşmaya sahip toprak, kirlenmiş bölgelerden gaz akışının eşit olmayan şekilde çekilmesine neden olabilir. Bir SVE sistemi (geçici veya kalıcı olarak) kapatıldıktan sonra, bu aynı zamanda kütle transfer işlemlerinin zamanla daha az etkili olduğu daha düşük geçirgenlik bölgelerinden kirletici geri tepmesine neden olabilir. Çıkarma kuyusu tasarımı/yerleştirme ve/veya SVE operasyonları (örn. ekstraksiyon kuyularının çevrimi, darbeli çalışma) ve olası kırılma ihtiyacının, değişen geçirgenlikleri/katmanlaşmayı ve geri tepme potansiyelini ele almak için dikkate alınması gerekebilir.
- SVE sistem tasarımı, bireysel ekstraksiyon kuyuları için hava akışı ve kirletici konsantrasyonlarının ölçülmesine izin vermelidir (hava üfleyici blowerdaki bileşik ölçümlere kıyasla). Bireysel kuyu ölçümlerinin hariç tutulması, uygun performans değerlendirmesine veya optimizasyona izin vermeyecektir. Heterojen litoloji için, daha geçirgen bir yerde taranan bir veya birkaç ekstraksiyon kuyusunun neredeyse tüm hava akışını hesaba katması nadir değildir. Kirletici çıkarma oranları zamanla azaldıkça, daha düşük kirletici temizleme oranlarına sahip ayrı ayrı çıkarma kuyularını kapatma veya kapatma seçeneği avantajlı hale gelir.
- Vakum ölçüm noktalarının kurulumu, arıtma bölgesi boyunca temsili sayıda konum, ayrıca ekstraksiyon kuyularından mesafeler ve daha derin arıtma bölgeleri için farklı toprak birimleri içindeki derinlikler için önerilir. Yeterli sayıda gaz sondasında yapılan vakum ölçümleri, tedavi alanı boyunca hava akış hızlarının ve dağıtım modellerinin genel bir tahminini sağlar. Yeniden doldurma etkisini ve uzaklaştırma ilerlemesini değerlendirmek ve ayrıca ele alınması gereken daha fazla optimizasyon gerektirebilecek etkisiz arıtmanın potansiyel "ölü bölgelerini" belirlemek için solunum (örn. oksijen) ve kirletici konsantrasyonu ölçümleri de toplanabilir.
- Yağıştan ve/veya SVE sistemine yükselen su tablasından su sızması, çeşitli operasyonel sorunlara yol açabilir. Hat tıkanmasını önlemek için transfer borularının ekstraksiyon kuyularına veya stratejik olarak yerleştirilmiş toplama noktalarına doğru eğimli olması gerekir. Daha büyük hacimli sığ yeraltı suyunun emme kaldırması veya sisteme çökelti sızmasının sürüklenmesi, hava/su ayırıcıyı bunaltabilir ve şiddetli korozyona ve üfleyici iç parçalarının (değiştirilmesi gereken) sıkışmasına neden olabilir. Yoğun yağış veya sığ yeraltı suyu dönemlerinde, bu sorunları önlemek için SVE sisteminin kapatılması veya vakum/hava akışının azaltılması gerekebilir.
- Gazdan arındırma işlemi genellikle gereklidir ve SVE operasyonlarının maliyetini önemli ölçüde artıracaktır. Örneğin, artık sıvılar işleme/bertaraf gerektirebilir, kullanılmış GAC'nin yeniden oluşturulması veya atılması gerekecektir ve termal/katalitik oksidasyonun çalışması için önemli elektrik/gaz maliyetleri gerektirebilir. Uzun vadeli proje planlaması, kirletici içeri giren madde

konsantrasyonları zamanla azaldıkça hava arıtmasını deęiřtirmek veya durdurmak için yeterli esneklięe izin vermelidir (örn. (örneęin, kiralık ekipman kullanımı, arıtma için izin gerekliliklerine karşı giriş suyunun sık sık izlenmesi).

- SVE etkinlięi zamanla azalma eğilimindedir ve sonunda simetrik olmayan/plato koşullarına ulaşır. Asimetrik/plato koşulları, kirletici kütlesinin öncelikle daha yüksek geçirgenlik bölgelerinden çıkarılmasının bir eseri olabilirken, düşük geçirgenlik bölgelerinden, daha yüksek nemli alanlardan kirletici kütlesinin çıkarılması veya toprak matrisine daha yüksek kirletici adsorpsiyonu ile ilgili zorluklar yaşanır. SVE sistem tasarımının ve operasyonlarının daha fazla deęerlendirilmesi, bunun belirli bir sahada gerçekleşmesi durumunda tavsiye edilir. Kalıcı kirletici konsantrasyonlarının yeraltı suyu konsantrasyonları veya buhar giriři üzerindeki etkisinin analizi, uygun modelleme araçları kullanılarak yapılmalıdır. Geri tepme testi ve vakum ölçüm noktalarında buhar konsantrasyonu ölçümleri, daha fazla sistem optimizasyonu veya sistem kapatma ihtiyacına ilişkin sağlam kararlar almak için arıtma alanı boyunca kalan kirletici seviyelerini deęerlendirmek için yapılmalıdır.
- Darbeli çalışma çözelgelerinin kullanılmasıyla SVE etkinlięi artırılabilir. Sistem kapalıyken kirleticiler gözenek boşluęuna yayılabilir ve ardından sistem aktifken süpürülebilir.
- Çıkış gazı sıcaklıęı tedavi seçeneklerini sınırlayabilir. İşlemden önce sıcaklıęı düşürmek için ısı eşanjörlerinin dahil edilmesine dikkat edilmelidir.

4 ARAZİ DENEYLERİ

TGE uygulaması için yüzeyaltını hava akımı açısından yeterince karakterize edebilmek kritik öneme sahiptir. Her ne kadar havanın kesin dağılımını tahmin etmeye çalışmak bu zamanda pratik olmasa da, bu dağılımların kabaca sahip olduğu karakteristikler basit jeolojilerde ön görülebilir (çok geçirgen ve homojen olan oluşumlar veya büyük ölçekli kil katmanları gibi heterojenlikleri olan kum ağırlıklı topraklar gibi) ve topraktan alınan karot örneklerinin görsel incelenmesi sonucu elde edilen bilgiler TGE uygulaması için paha biçilemezdir.

Arazinin karakterize edilmesi aşaması sonunda ve tarama ile pilot test fazlarından önce, eldeki arazi karakteri ilişkili veri hedef iyileştirme bölgesi tanımlamada ve alandaki hava dağılımı için bir kavramsal model önermekte kullanılmalıdır.

TGE pilot uygulaması son sistem tasarımı için aşağıda belirtilen parametrelerde güvenilir veri sağlamalıdır:

- hedef uygulama bölgesini tanımlamak
- işbu hedef bölgedeki hava dağılımı için kavramsal model geliştirmek
- sürdürülebilir hava akımı hızları
- Toplam gaz ekstraksiyon hızı
- Beklenen kirletici gazı giderim hızları
- Tercih edilecek yüzeyaltı hava akımı yönelimi
- Etkili olduğu yarıçap. Ayrıca kuyular arasındaki boşluğun maliyet dolayısıyla zorlayıcı olup olmadığına karar verin ve eğer zorlayıcıysa maliyet-zorlayıcı olmayan minimum kuyu aralığını belirleyin.
- Kuyuların derinliği, konumu ve inşaatıyla ilgili bilgilerin önerisini yapın
- Gereken gaz ekstraksiyon kuyusu sayısı
- Sistem çıkış gazı için gaz arıtımı teknolojisi



Şekil 4.1- Pilot test sonrası etki yarıçapı (Confalonieri vd., bkz. Ek1)

TGE tasarım parametrelerine karar verecek olan temel faktörler şunlardır: (1) topraktaki kirliliğin doğası ve boyutu, (2) topraktaki geçirgenliğin dağılımı (heterojenlikler vb.) ve (3) ayıklanan toprak gazındaki kirletici derişimi. Bu bilgilerin ortaya çıkan kavramsal saha modelinde erişilebilir olarak bulunması beklenir.

Tam ölçekte bir sistemin tasarım parametrelerini belirlemede gerekli verileri sağlamanın yanında, düzgünce gerçekleştirilmiş bir pilot test danışmana işbu projedeki zaman kısıtlamalarının karşılanıp karşılanamayacağına yönelik de yardımcı olacaktır. Bu ulaşılabilir gaz giderim hızlarının değerlendirilmesiyle belirlenebilir.

ACTIVITY	QUESTION(S) ANSWERED
Enjeksiyon basınç/debi testi	İstenilen debinin makul basınçlarda elde edilmesi mümkün mü?
Helyum iz testi	Hava dağılımının yaklaşık olarak yatay düzlemdeki kapsamı nedir? Yön eğilimleri belirten herhangi bir gösterge var mıdır?
Haza gazı/çıkış gazı örnekleme	Buharlaşma hızı nedir? Herhangi bir göze çarpan düzeyde güvenlik tehlikesi var mı?
Çözünmüş Oksijen (DO) ölçümleri	Hava dağılımının yaklaşık olarak yatay düzlemdeki kapsamı nedir? Yön eğilimleri belirten herhangi bir gösterge var mıdır?

4.1 Geleneksel /Bilinen Pilot Test

TGE uygunluğunu değerlendirmek açısından geleneksel saha karakterizasyonu verileri önemli olsa da bunlar görece statik bir görünüm sağlar ve tam kapasite tasarım için yeterli veri sağlamazlar. Özellikle kirleticinin kütsel giderimindeki dinamik davranışı tahmin etmek TGE için pilot test yapmadan oldukça zordur. Ekstraksiyondaki dinamik davranış çoğunlukla şu etkenlere bağlıdır: kirlenmiş toprak hacmi, advectif ya da difusif olarak karakterize edilmiş toprak hacminin birbirlerine oranı, difuzyon sınırlı kaynak bölgelerin kütle transferi özellikleri, kaynaklara göre ekstraksiyon perdelerinin konumları ve sulu çözeltide olmayan fazda sıvıların (NAPL) varlığı. Aşağıdaki tartışma NAPL 'ı göz önünde bulundurmamaktadır, yine de belli bir bölgedeki ısrarlı olarak aynı derişim miktarlarının arka arkaya birden fazla ekstraksiyon periyotlarında neredeyse tıpatıp aynı miktarlarda görülmesi NAPL göstergesidir.

Daha erken bir pilot test çalışması iyileştirme prosesi planlaması aşamasında, tercihen saha karakterizasyonu çalışmasının bileşeni olarak gerçekleştirilir. Böylece çalışma başladıktan sonra tasarım değişikliklerine gerek kalma olasılığı daha az olacaktır. Özellikle görece büyük ve karmaşık sahalarda pilot test kesinlikle önerilir.

Bir pilot testin tasarımının yapılması istenen bir toplam gaz ekstraksiyon hızı ya da ekstraksiyon süresi olmasını gerektirir. İdeal olarak pilot testi kirlenmiş topraklardan bir ya da daha fazla gözenek hacmine karşılık gelecek hacimde çekim yapar. Bu testin amacı ayıklanan gazdaki ilk VOC derişimi düşüşünü ve değişen uzaklıklardaki toprak gazı sondalarında da derişim düşüşlerini gözlemleyebilecek kadar uzun süre çalıştırmaktır. Bu kütle transferi kısıtları üzerine ilk tahminleri verip tek bir kuyunun etkili olduğu yarıçapı da belirlemeye başlayacaktır [DiGiulio ve Varahan, 2001a]. El yordamıyla düşünülüğünde pilot testin ne hızda ve sürede yapılacağı kavramsal saha modelinde toplam kirlenmiş toprak hacmi (V), toprak gözenekliliği ve toprak nem içeriğine aşağıdaki denklemdeki gibi hesaplanabilir:

$$Q = V_{\text{toprak}} (1-S)$$

Aşağıdaki şekilde 3 günlük 64 Nm³/hr ekstraksiyon işlemi sonrasında şüphelenilen TCE gazı kaynak bölgesine yerleştirilmiş kuyudaki TCE gaz derişimleri verilmiştir. Ayıklanan gazdaki derişim toprak gazı ekstraksiyon ve değişim hızıyla da bağlantılı şekilde ekstraksiyonun ilk saatlerinde hızlı bir düşüş gösterdi. Daha sonraki ardışık ekstraksiyon işleminde TCE derişimi çok daha yavaş düşüşler göstermeye başladı. Bunun nedeni vadoz bölgenin ortasındaki kil biriminden kaynaklanan difusif kütle transferi kısıtlarıydı. Bu gözlemlerin gösterdiği işbu pilot sistemin bu sahadaki tam ölçekli bir sistemin yerini tutabilecek düzeyde olduğudur. Aktif karbonun çıkış gazı buharını arıtmada da maliyet açısından uygunluğu gösterilmiştir.

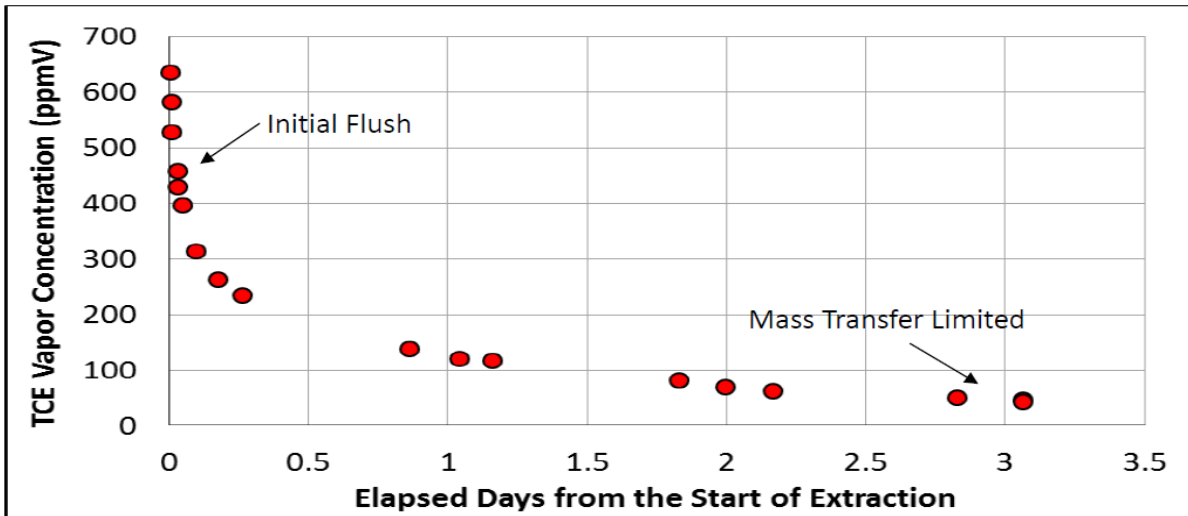

Şekil 4.2- TGE pilot testinden örnek gaz konsantrasyon verisi

Daha düşük toprak geçirgenliklerinde istenen debiye ulaşabilmek için ikinci bir kuyu yerleştirilmesi gerekebilir ya da daha uzun yıkama süreleri tasarlanabilir. Ancak bu şekilde kütle transfer kısıtları ortaya çıkacaktır. Daha sonra da açıklanacağı üzere, kütle transfer kısıtlarıyla ilgili ek bilgiler ekstraksiyon kesildikten sonra TCE derişiminin ne düzeyde geri geldiği (rebound) ölçülerek elde edilmiştir. Buna ek olarak, eğer TCE gaz derişimi başlangıçta görece yüksektiye ve ilk çökme sonrası yine de görece yüksek değerlerde kalabildiye, ki bu yoğun sulu çözeltide olmayan sıvı faz (DNAPL) varlığı göstergesidir, karbon tutunumu yüksek kütlece ekstraksiyon hızları için uygun maliyetli bir seçenek olmayabilir.

Eğer halihazırda yapılmış saha karakterizasyon çalışmalarından kalmamışsa, izleme noktaları birden fazla derinlikte, hatta alt katmanda dahi kurulabilir ve söz gelimi 3-15 metre uzaklıklarla ekstraksiyon kuyusunun etki yarıçapı içerisinde olacak şekilde kurulabilir. Her izleme noktası yeraltı suyu derinliği ve jeolojik katmanlaşmaya bağlı olarak değişen dikey nokta kümelerine sahip olabilir.

Aşağıdaki Sekil 4.3'te de gösterildiği gibi bu noktalar tahmin edilen kirletici kaynağının üstünde, altında ya da içinde olacak şekilde yerleştirilebilir. Pilot test sırasında gaz derişimini ve vakum tepkilerini ölçmek için bu konumlar kullanılır.

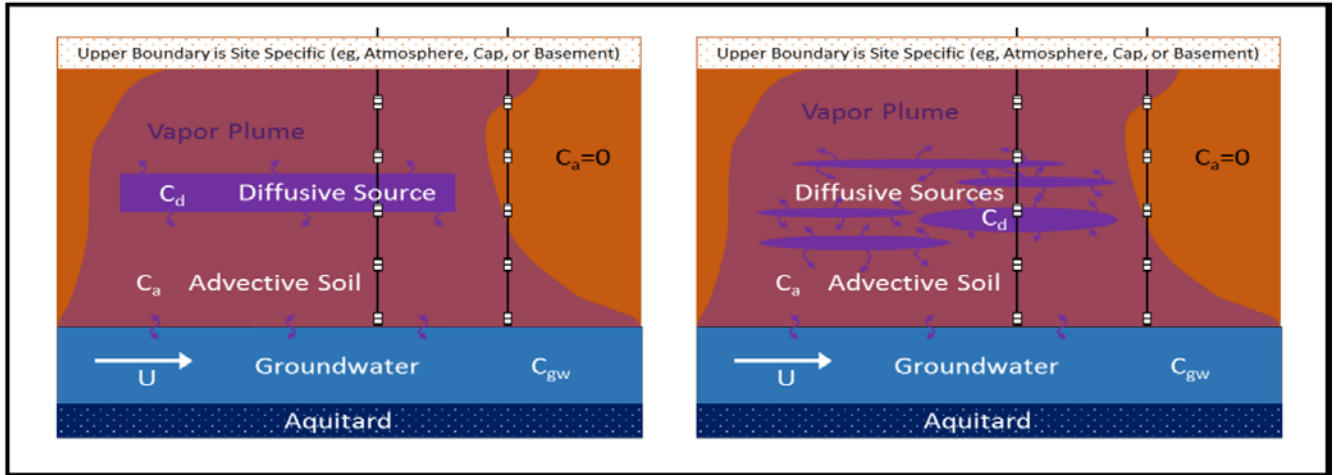

Sekil 4.3- Difüzyon sınırlı kütle transferi ve tipik toprak gazı izleme noktaları için kavramsallaştırılmış senaryolar

Vakum verisinin ne düzeyde kullanışlı olacağı toprağın geçirgenliğine doğrudan bağlıdır ve TGE'nin etki yarıçapını belirlemede bu verilere güvenilemez. Daha önemli olanı gaz derişiminde değişikliklerdir. Geçirgen kumlu topraklarda çok küçük bir vakum uygulaması görece yüksek hava akımlarına neden olabileceken killi topraklarda büyük ölçekte vakum uygulamaları pek hissedilebilir bir hava akımına neden olamayabilir. Fakat vakum izleme verileri dikey düzleme karşılık yatay düzlemdeki akımları ve yüzey koşullarının (söz gelimi bir levha boyunca sızıntı için düşük geçirgenlik ya da atmosfere açık bir toprak yüzeyi) yüzeydeki toprak hacimlerinde yıkama düzeyine olan etkilerini anlamada kullanılabilirler.

Pilot test sırasında uçucu organik bileşiklerin (VOC) buhardaki derişimlerinin sağlam bir izleme programıyla denetlenmesi toprak gazı izleme noktalarındaki eğilimleri tespit edebilmek için önerilir. Bu eğilimler pilot testte yıkanabilmiş toprak gözenek hacmiyle ilişkilendirilebilir istenen yıkama sıklığındaki (söz gelimi gözenek hacmi derişim hızı) tam kapasite tasarımın hazırlanmasında bir sonraki bölümde detaylandırılacağı gibi ekstraksiyon kuyularının aralıklarının belirlenmesinde kullanılabilir. Toprak gazı VOC verisinin hacmini uygun maliyetle artırabilmek için deneyimli bir uygulayıcı ile arazide gaz kromatografi kullanımı teşvik edilir.

Çoğunlukla sağlık, güvenlik ve kamu endişelerinden ötürü çıkış gazlarının arıtılmadan deşarj edilmesi kabul edilemez. Eğer koşullar bunu gerekli kılıyorsa çıkış gazı arıtımı için aktif karbon, termal oksidasyon ya da diğer ilgili teknolojiler atmosfere salınacak çıkış gazındaki kaliteyi artırmak için uygulanabilir.

4.1.1 Geleneksel Pilot Test Ekipmanları

TGE pilot testi çalışması için gereken ekipmanlar aşağıda belirtilenleri ya da eşleniklerini içerebilir [Farallon, 2019]:

- Bir adet bir beygir gücünde kızaklı geri kazanımlı Rotron DR 404 denginde minimum 50 inç su kolonu vakumu (127 cm) ve dakikada 105 standard fit küp (2.9733 metreküp) debiye ulaşabilen fan.
- Vakum göstergeli bir nem ayırıcısı, vakum tahliye vanası ve drenaj vanası.
- Bir seri vanadan oluşan bir manifold, vakum göstergeleri ve dakikada 0.66'dan 100 standart kübik fite (0.0187'den 2.8317 metreküpe) kadar ölçüm yapabilen ve 0.1 ile 80 inç (0.254 ile 203.2 cm) su kolonu basıncında çalışabilen akım metre
- TGE ekstraksiyon kuyusundan gaz deşarj noktasına ekipmanları bağlamak için kauçuklanmış esnek birleştiriciler, hortumlar ve/ya Schedule 40 polivinil klorür bağlantılar

Gözlem kuyuları küresel vanada sonlanan vakum geçirmez bağlantı parçalarına sahip olmalıdır. Bu vanayla vakum ölçerle bağlanıp pilot çalışma boyunca gözlenen vakumun izlenmesi sağlanacaktır. Proses ve cihaz diyagramı aşağıdaki Şekil 4.4'te verilmiştir.

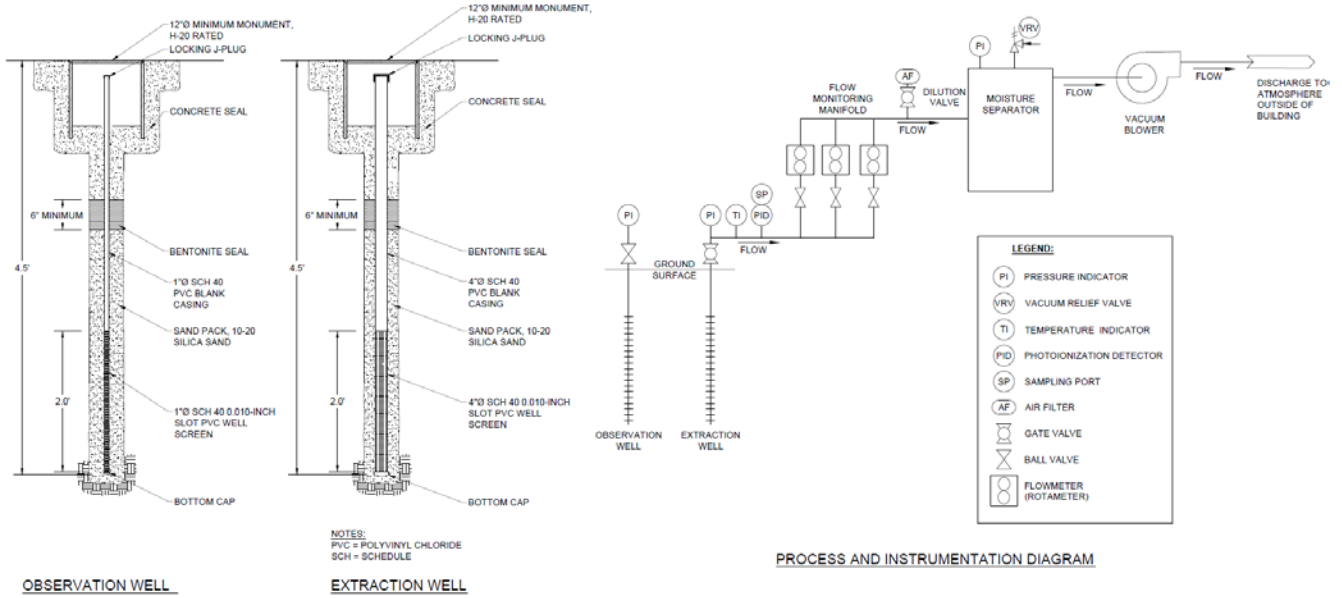

Şekil 4.4- Örnek proses ve cihaz diyagramı (Farallon Consulting)

4.1.2 TGE'de artan vakum basamağı testi

TGE pilot testi en az 3 farklı hava akımı debisi basamağına sahip olacak şekilde gerçekleştirilmelidir. Testteki her bir basamağın süresi en azından vakum izleme noktalarında ölçülen parametrelerinin her birinin durağan koşula ulaşılmasına kadar sürmelidir. Ekstraksiyon kuyusunda ki ve bütün toprak vakum izleme noktalarında basınç ölçümleri gaz ekstraksiyon kuyusundaki debi ve vakum sabit tutulurken (bunu yapabilmek için sık sık ölçümler yapılmalıdır) alınmalıdır. Pilot testin başlangıcında ölçümler sık olmalıdır (her 5 ya da 10 dakikada bir gibi); bu ölçümler arası zaman test ilerledikçe uzatılabilir.

Pilot test için minimum olarak bir adet toprak gazı ekstraksiyon kulesi ve 3 adet ekstraksiyon kuyusundan farklı uzaklıklarda konumlara yerleştirilmiş vakum izleme noktaları önerilmektedir. Her ne kadar bu işe adanmış toprak gazı ekstraksiyon kuyuları ve izleme noktaları tercih edilecekse de uygun konum ve yapıda olan yeraltısuyu izleme kuyuları da kabul edilebilirdir. Bu sözü edilen yeraltısuyu kuyularının TGE ekstraksiyon kuyusu ya da izleme noktası olarak kullanımının kabulü sahaya özgü olarak yapılacaktır. Genel bir kural olarak vakum izleme noktaları gaz ekstraksiyon kuyularından 5 ila 10 feet (1.524 ila 3.048 metre), 10 ila 20 feet (3.048 ila 6.096 metre), 20 ila 40 feet (6.096 ila 12.192 metre) ve 40 feet'ten (12.192 metreden) daha uzak olacak şekilde 5 farklı konumda bulunmalıdır. Vakum izleme noktaları çizgisel bir şekilde dizilmekten ziyade ışınsal olarak, söz gelimi 120° açılarla yerleştirilmesş sahadaki hava akımının daha kolay geçtiği potansiyel öncelikli patikaları değerlendirmeye yarayacaktır. Eğer topraktaki kirlenme birden fazla farklı geçirgenlikte olan birimde gerçekleşmişse her bir birim kaymanı kendi toprak gazı ekstraksiyon kulesi ve 3 adet gaz izleme noktasıyla değerlendirilmelidir.

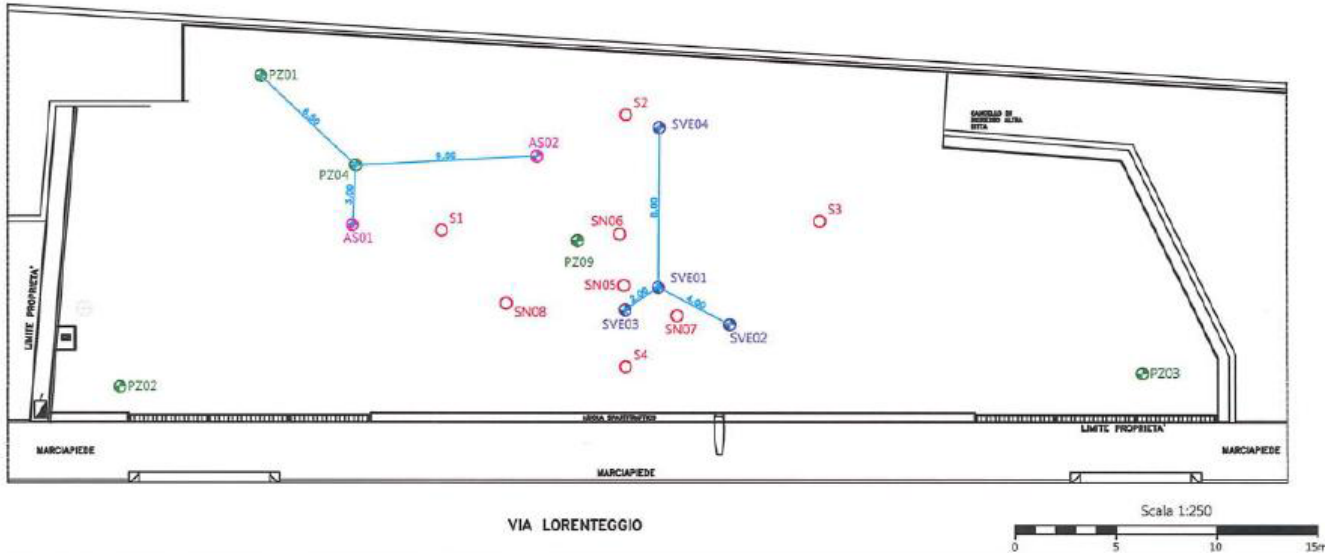

Şekil 4.5- TGE izleme noktasının 120° 'sinde tipik bir konuşlandırma (Confalonieri vd., bkz Ek1)

Tipik bir hava ekstraksiyon kuyusu 1 ila 4 inç (2.54 ila 10.16 cm) çapında dikey bir kuyu olup 1 ila 5 fit (0.3 ila 1.52 metre) uzunluğunda perdelenme aralığına sahiptir fakat bu parametreler sahaya özgü olarak belirlenmelidir.

TGE basamaklı test aşamasının uygulanmasından önce gözlem kuyularından arka plan basınç verileri toplanacaktır. Ayrıca organik buharlar için FID ya PID ve explosimetre ile yapılacak bir tarama çalışması da önerilmektedir.

TGE basamak testleri TGE ekstraksiyon kuyusunda uygulanan vakumun çok küçük kademelerle artırılması ile gerçekleştirilir. Uygulanabilecek maksimum vakum su tablası ile vakuma maruz kalacak perdenin en üst noktası arasındaki mesafeye ya da elde bulunan ekipmana bağlıdır. 1 beygir güçlü rejeneratif fana göre oluşturulan fan eğrilerine dayanarak TGE ile ekstraksiyon kuyusunda uygulanabilecek maksimum vakum tahmini olarak 50 inç (127 cm) su kolonudur [Farallon 2019]. Küçük artımlar fandaki maksimum vakumlama hızının % 30'luk, 70'lik ve 100'lük oranlarında uygulanacaktır. Basamak testinin her bir aşamasında aşağıda belirtilen parametreler minimum olarak 15 dakika aralıklarla ilgili ölçütler stabilize olana kadar (ölçümler arası % 5'ten daha az değişim) ya da maksimum olarak her basamakta 2 ila 3 saat boyunca izlenmelidir:

- TGE ekstaksiyon kuyusuna uygulanan vakum değeri
- TGE ekstraksiyon kuyusundaki ekstraksiyon debisi

- Ayıklanmış gazın sıcaklığı
- Bir fotoiyonizasyon dedektörü ile ayıklanan gaz akımındaki uçucu organik bileşim derişimlerinin ölçümleri
- Gözlem kuyularındaki vakum
- Vakum değerleri ölçülen basınç değerleri şeklinde kaydedilecek.

minutes	Pid	Lel	O2	CO2	Depress	V	T	Q
	ppm	%	%	%	mbar	m/s	°C	mc/h
0	480.1	18	21.3	1.22	-286.0	7.74	1.4	47
10	2147.0	16	21.5	3.45	-258.0	6.57	0.8	47
30	2371.0	13	20.9	3.16	-249.0	6.23	4	43
60	4106.0	13	20.9	2.7	-236.0	6.77	4.1	50
90	4469.0	10	20.9	2.26	-232.0	7.46	4.6	53
120	5000.0	10	20.9	2.08	-229.0	8.27	5.2	57
180	5000.0	9	20.9	1.83	-225.0	9.03	5.9	64
240	5000.0	9	20.9	1.62	-222.0	9.53	6.9	67
300	5000.0	8	20.9	1.44	-220.0	9.6	7	72

Şekil 4.6- İzleme masası örneđi (Confalonieri vd., bkz. Ek1)

Gaz örnekleri Summa metal tüplerinde ve/ya Tedlar çantalarında ve/ya benzer ve denk destekli kaplarda toplanmalı ve her basamağın sonunda PID ile ayıklanan gazda ölçülen en yüksek derişim değerinde laboratuvar analizine gönderilmelidir.

AIR FLOW RATE VERSUS VACUUM

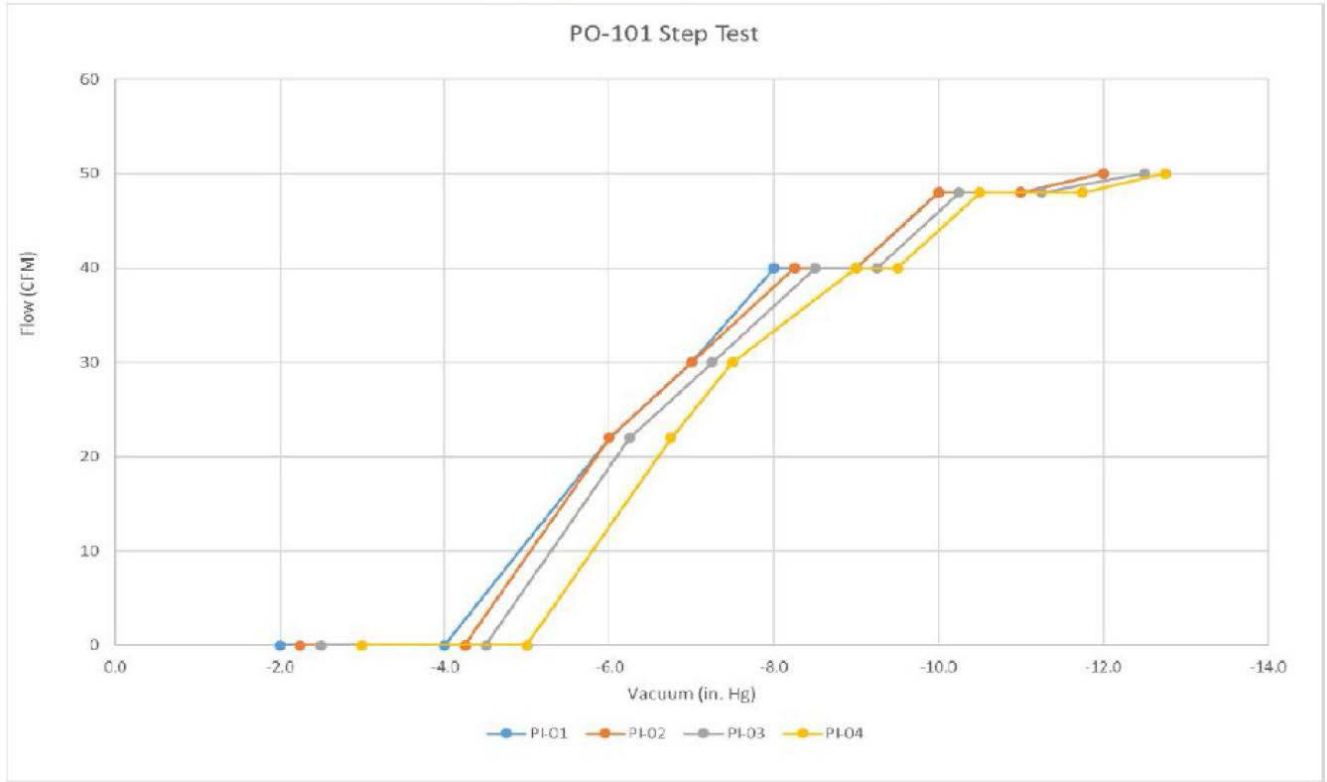

Şekil 4.7- TGE artan vakum basamağı testi örneği (Menozzi vd., bkz. Ek1)

4.1.3 TGE Sabit Vakum Testi

TGE'deki basamaklı testten sonra ideal vakum ve ekstraksiyon debisi elde edileceği için TGE pilot çalışmasının ikinci bileşeni olan sabit vakum testi aşamasına geçilebilir. Optimum vakum ve debi ekstraksiyon kuyusunda gözlenen vakum ve debilere, gözlem kulelerindeki vakum tepkisi ve gaz geri kazanımına ve yeraltısuyu düzeylerine olan etkiye bakarak belirlenmelidir. Optimum debi aynı zamanda basamak testi aşamasında ölçülen etki yarıçapından da belirlenebilir.

TGE Sabit Vakum Testi TGE basamak testinden hemen sonra uygulanmalı ve yaklaşık olarak 24 saat boyunca çalıştırılmalıdır. Basamak testinde izlenen parametreler bu sabit vakum testinde de izlenip 15 dakikalık aralıklarla kayıt edilecektir. Bu parametreler:

- TGE ekstraksiyon kuyusuna uygulanan vakum değeri
- TGE ekstraksiyon kuyusundaki ekstraksiyon debisi
- Ayıklanmış gazın sıcaklığı
- Bir fotoiyonizasyon dedektörü ile ayıklanan gaz akımındaki uçucu organik bileşim derişimlerinin ölçümleri
- Gözlem kuyularındaki vakum
- Vakum değerleri ölçülen basınç değerleri şeklinde kaydedilecek.

Arazide yapılan gözlemlere dayanarak pilot testteki izleme zamanı aralıkları değiştirilebilir. TGE Sabit Vakum Testinin daha uzun süre olması durağan koşullara ulaşıldığındaki salım derişimlerini ve sahaya özgü operasyonel TGE hava akımı ve vakumunun değerlendirilmesine yardımcı olur.

Gaz örnekleri Summa metal tüplerinde ve/ya Tedlar çantalarında ve/ya benzer ve denk destekli kaplarda toplanmalı ve TGE Sabit Vakum Testi sonunda laboratuvar analizine gönderilmelidir.

4.2 Helyum Dağılımı ve Geri Kazanımı Testi

Her ne kadar sınırlı arzdan dolayı Helyum iz testi yayın bir pratik olmasa da bu yöntemin bir diğer güçlü yanı kolay bir şekilde tekrarlanabilmesi ve tekrarlar arası gecikmenin yalnızca bir kaç saat ve türevi olmasıdır. Bu sayede prostedeki değişimlerin, söz gelimi kuyulardaki hava akımı dağılımdaki değişimlerin hızlı bir şekilde değerlendirilmesi mümkündür.

Görece ucuz, rahat bir şekilde bulunabilen ve arazi kullanımı için gerekli ekipmanların ulaşılabilir olmasından dolayı helyum en sık kullanılan izleme gazıdır. Tipik dedektörler helyum derişimini 0.1 % ile 100 % derişimler arasında tespit edebilmektedir. Fabrikada kalibre edilen bir sistem olduğundan arazide tekrar kalibre edilme duruma olmayacaktır, fakat cihazın uygun bir şekilde çalışıp çalışmadığını kontrol etmek için helyum standartlarıyla çeşitli kontroller yapılmalıdır. Tipik olarak gaz örnekleri metal tüpler ya da Tedlar çantalarında toplanmalıdır. Daha sonra ölçüm için helyum dedektörü örneğin konteynırına doğrudan tutturulur. Alternatif olarak helyum dedektörü sürekli örnekleme sistemi şeklinde modifiye edilebilir. TGE çıkış gazı için kesintisiz örnekleme yapmak bu tarz kesintisiz bir gaz akışı uygun olarak bulunurken oldukça kolaydır.

Burada tanımlanan iz geri kazanımı testleri pilot testin bir parçası olarak ya da tam kapasite operasyonda yapılabilir. Testler uygulama ve yorumlama açısından oldukça basittir. Kabaca, etkileşimi girmeyen bir iz (çoğunlukla helyum) zemine sabit ve bilinen bir hızda uygulanır ve TGE çıkış gazında bu iz içeriğın derişimi takip edilir. Belli bir zaman sonra (bir çok sistem için bu bir saat ya da daha azdır) çıkış gazında verilen izin derişimi artmaya başlar. Belli bir süre bu artış devam ettikten sonra sabit bir yüzeye ulaşır. Elde edilebilen havanın yüzdesi şu şekilde hesaplanabilir: helyumun TGE'deki derişimi sabitlendikten sonraki hava derişim değeri TGE debisiyle çarpılır ve bu sonuç izin enjekte edilme hızına aşağıda verildiği gibi bölünür.

$$\%Recovery = \frac{SVE \text{ flowrate}}{Trace \text{ injection rate}} \times \% \text{ tracer in offgas} \times 100$$

% hava kazanımı= TGE debisi çıkış hazındaki % iz 100

Daha sağlam bir arazi geri kazanım testi ise öncelikle TGE manifolduna doğrudan izi enjekte edip %100 geri kazanım derişimine karşılık gelen değeri ölçmektir. (Her iki durumda da akımın aynı olmasına özen gösterilmelidir çünkü iki sistemin geri-basınçları ciddi ölçüde farklıdır.) Bu durumda da % geri kazanım TGE çıkış gazında ölçülen helyum derişiminin % 100 geri kazanım derişimine bölünmesiyle bulunur.

Eğer iz olarak helyum kullanılıyorsa yukarda kalma sorunları (buoyancy) olmaması için enjeksiyon derişimi hacimce % 10'un altında tutulmalıdır Değişen geri basınç koşullarında tutarlı helyum akımını elde edebilmek için kalibre edilmiş doğrudan okuma sistemli akım metre basınç ölçer ve ölçme vanasıyla birlikte kullanılmalıdır. Böylece akım metrede yüksek geri basınç elde edilir.

İz geri kazanım testi sistem performansı için "tehlike işareti" olacak şekilde tasarlanmıştır. Eğer iz geri kazanımı düşük ise havanın ve izin su tablası altında düşük geçirgenliği olan katmanlarda kilitlenip kalmış olması olasıdır ve TGE sistemin ulaşabildiği yerlerin dışında yatay olarak hareket ediyor olabilir.

Bazı durumlarda kesintisiz katmanlardan dolayı kuyuya hiç helyum gelmemesi de olasıdır. Bu gibi katmanların varlığı sistem açılış ve kapanışı sırasında yapılan yeraltısuyu basıncı izlemelerinde de belirlenebilir olmalıdır. Böylelikle, helyum geri kazanım testinin yeraltısuyu basınç ölçümleriyle birlikte uygulanması önerilmektedir.

Eğer helyum geri kazanımı söz gelimi % 80'den daha yüksek ise bu TGE sisteminin iyi çalıştığını ve gazın yatay hareketinin bir problem teşkil etmeyeceğini gösterir.

4.3 Toprak Gazı İzlemesi

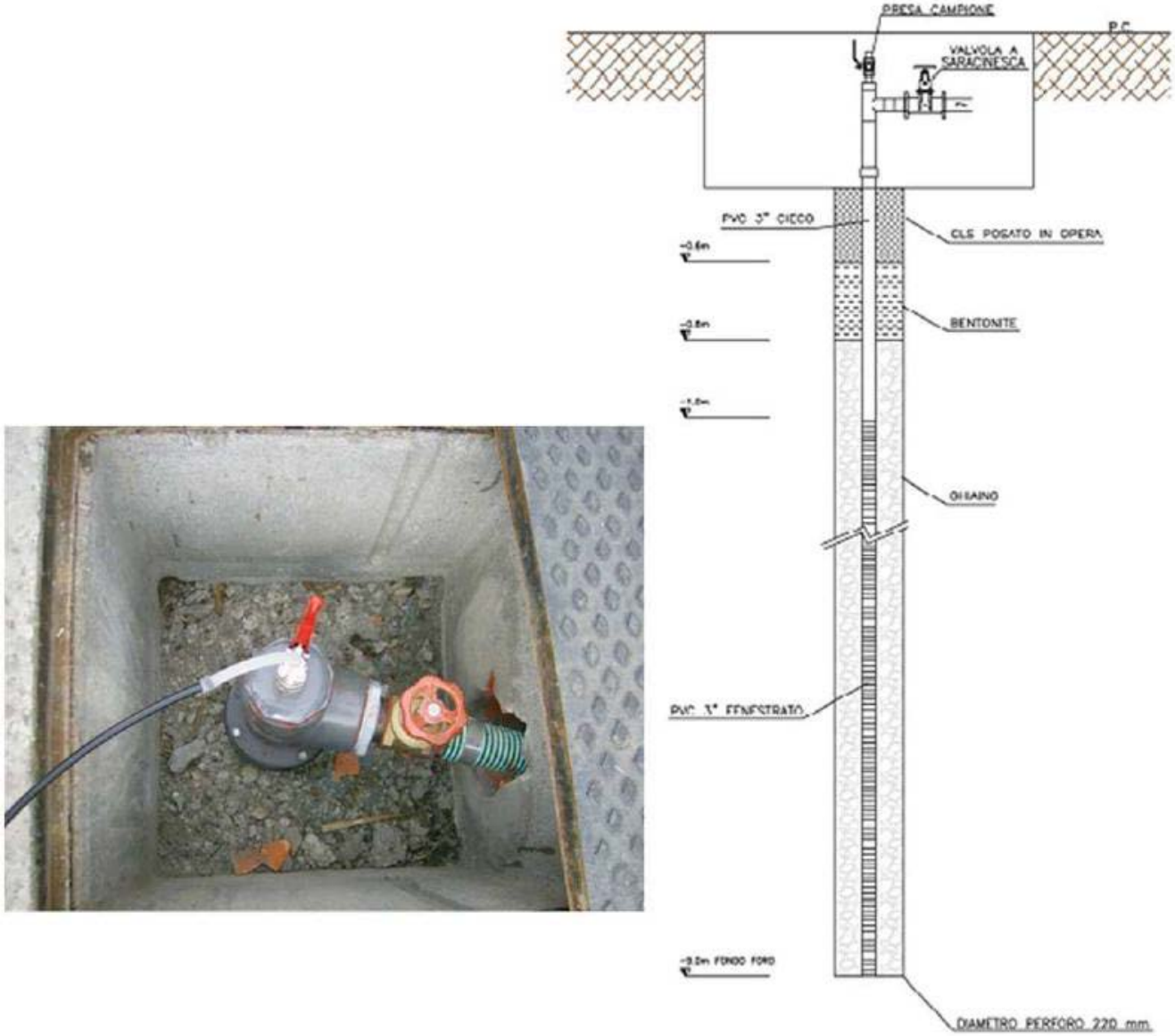

Şekil 4.8- Yuva Sonda Kurulum Örneği (Trezzi vd., bkz. Ek1)

Pilot test sırasında olası laboratuvar analizi için her bir debi basamağında toprak gazı ekstraksiyon kuyusundan toprak gazı örnekleri toplanmalıdır. Laboratuvara analize gönderim açısından örnekleme sıklığı ve örnek sayısı sahaya özgü koşullara göre belirlenmelidir. Yine de minimum olarak arazi cihazlarında okunan en yüksek değer görüldüğü basamaktan bir adet örnek laboratuvara gönderilmelidir. Gaz örnekleme kuyunun başı ile fan arasındaki örnekleme deliğinin bulunduğu gaz ekstraksiyon noktasından yapılmalıdır. VOC, CO₂ ve O₂ analizleri için örnekler Tedlar çantasıyla, odun kömürü içeren tüple ya da Summa-tipi metal tüplerle toplanabilir, ki en sonuncusu önerilir. Analitik yöntem projenin teknik ekibi tarafından onaylanmış olmalıdır. Draeger tüpleri CO₂ ölçümleri için yaygın olarak kullanılmaktadır ve VOC derişimleri ölçmek için de kabul

edilebilir. Eğer belirli minimum raporlama gereksinimleri sahaya özgü koşullardan ötürü karşılanamayacaksa bu açıklanmalı ya da tartışılmalıdır.

Çıkış gazındaki kirletici derişiminde artış ve TGE ekstraksiyon hızı kirletici kütlesi giderim hızını belirlemede kullanılabilir. Elbette ki pilot testin kısa süresi sırasında yapılan denemeler uzun dönem performansın ne düzeyde olacağını kesin olarak göstermez. Yine de genel olarak pilot testte görülen performansın sistemin maksimum verimini belirttiği varsayılabilir. Bu bağlamda söz gelimi pilot denemenin kapanışında ölçülmüş kütleli giderimler çok düşük ise bu sahada TGE sisteminin işe yararlılığı konusunda ciddi endişeler oluşmalıdır.

4.4 TGE arazi denemesi için minimum olması gereken ekipmanlar

TGE sistemi için yapılacak bir pilot test mekanizması kirletici alan üstünde bir ekstraksiyon kuyusu, benzer yapıda ama belgelendirilmiş bir kirletici kaynağı olmayan başka yere konuşlandırılmış bir kuyu ve ilgili gözlem kuyularını içerir. Pilot test konfigürasyonunun diğer önemli bileşenleri:

- Taşınabilir fan ya da vakum ayıklayıcı
- Kuyu örnekleme delikleri
- Ekstraksiyon kuyuları için ölçüm cihazları
- Örnek toplama ekipmanı

Yaygın kullanılan ölçüm aletleri:

- fotoiyonizasyon ölçücü dedektör (PID), salınan uçucu bileşiklerin miktarını ölçer
- Belli miktarda vakum pompaları / ölçümleri ve hava geçiş hızı ölçerleri ile ekstraksiyon kuyusunun etki çemberinin belirlenmesinde yararlanır
- sıcaklık ölçerler ile toprak gazının sıcaklığı belirlenir, ki bu parametre genel hava akışı hızını etkileyebilmektedir.

Örnek ekipmanlar içinde:

- ""Tedlar"" çantalar ve portatif hava pompaları, giriş ve çıkış örnekleri toplayabilmek için
- Tek kullanımlık ""bailers"" lar, gözlem kuyularından su ya da ürün örnekleri toplayabilmek için

4.5 Ekstraksiyon Kuyusu

Ekstraksiyon kuyuları SVE iyileştirme pilot deneme sistemlerinin temel birimini oluşturmaktadır. Bu kuyular kirleticilerin vadoz bölgeden çıkarılması için negatif basınç değişimi uygulayarak bir yol oluşturur. Kirleticiler ekstraksiyon kuyularına doğru "emilirler" çünkü bu noktalarda bulunan basınç diğer yerlere göre daha azdır. Bir giderim tekniği olarak gaz ekstraksiyonunu uygulayan bir iyileştirme tekniğinin başarılı olabilmesindeki kilit nokta bu basınç değişikliğinin ne düzeyde/miktarda uygulanacağını doğru belirlenmesidir. Bu tip bir bilgiyi elde etmenin yaygın bir yolu pilot test uygulamasıdır.

Elbetteki yalnızca ekstraksiyon kuyusundan örnekleme yapılırsa elde edilen yapıbozun bir çok parçası eksik olacaktır. Her ne kadar ekstraksiyon kuyusunda yapılacak gözlemler bu sahanın ekstraksiyon yapılan alanındaki değişimi gösterecek olsa da bunun pek de ötesine gitmeyebilir. Burası gözlem kuyularının çok önemli olduğu noktadır. Gözlem kuyuları ekstraksiyon kuyularına benzer bir şekilde perdelenmiş olup yeraltısuyu düzeylerindeki dalgalanmaları, gaz basıncı değişimlerini ve hatta kirletici bulutundaki göç olaylarını ölçüp uygulayıcıları bilgilendirebilecektir. Hem ekstraksiyon hem de gözlem kuyularından düzenli olarak örnekleme yapıldığında bilim insanları büyük resmi görebilecektir ve bu her halükarda bunun yalnızca bir parçasını ölçen

sistemlerden daha doğru bir sonuca ulaştıracaktır. İdeal olarak yapılan ölçümler içerisinde su düzeyi göstergesi ile ölçülmüş yeraltı suyu tablası , arayüz sondası ile ölçülecek herhangi bir serbest faz ürünün kalınlığı ve fotoiyonizasyon ölçerler ile belirlenecek VOC'ların derişimleri bulunmalıdır. Toplanan örnekler ekipmanlara giren ve çıkan hava örneklerini ve ayıklanan gazı uygulanan herhangi bir çıkış gazı arıtımı sonrası oluşan gazı içermelidir. Bu toplanan örneklerin laboratuvar ortamında uçucu organik bileşikler (VOC) ve toplam petrol hidrokarbonları (TPH) değerleri açısından analizleri yapılmalıdır. Analizler için sahaya özgü çeşitli gereksinimler de farklı olabileceğinden her halükarda yerel düzenleyici otorite ile iletişime geçip öneri/rehberlik almak iyi olacaktır.

4.6 Pilot Test Önerisi - Minimum Başvuru Gereklilikleri

1. Arazideki prosedürleri, pilot testin sonuçlarını ve aynı zamanda etki yarıçapının belirlenmesini ve kirletici bileşimi ile gaz giderim hızlarının tartışılmasını içeren anlatı.

2. Statik (test öncesi) veri:

- Statik su tablası verisi (en yakın 0.01 ft (0.3 cm) hassaslığında), eğer izleme kuyuları kullanılıyorsa vakum izleme noktaları ya da gaz ekstraksiyon noktaları şeklinde;
- Toprak ve hava sıcaklığı;
- Statik basınç (inç H₂O (su)), ve atmosferik koşullar (basınç ve sıcaklık)

3. Ekstraksiyon noktasında toplanan test verisi (belirli zaman aralıklarında raporlanır)

- Hava debisi;
- Eğer izleme kuyuları varsa 0.01 ft (0.3 cm) hassasiyetinde su kütlesi yüksekliği
- VOC, CO₂ ve O₂ derişimleri;
- FID(ya da PID ve explosimetre) ölçümleri
- basınç;
- Toprak ve hava sıcaklığı;

4. Vakum izleme noktasında toplanan test verisi (belirli zaman aralıklarında raporlanır)

- vakum (H₂O inç);
- 0.01 ft hassasiyetinde su kütlesi yüksekliği

5. Şekiller

- Kaynak alan(lar)ın konumlarını, ekstraksiyon ve vakum izleme noktalarını, yapıları, döşenmiş alanları ve yardımcı hendekler, toprak ve yeraltı suyu kirliliğinin kapsamını ve su tablasını ölçekli olarak gösteren saha haritaları
- Sahanın önemli jeolojik özelliklerini, kirletici dağılımını ve ekstraksiyon/izleme noktalarının konumlarını gösteren jeolojik kesitleri;
- Ekstraksiyon kuyuları ve vakum izleme noktalarının inşaat diyagramları.
- Manifold tasarımının inşasının şematik gösterimi. Bileşenler borular, cihazlar, vanalar, örnekleme delikleri ve pilot deneme sisteminde bulunan diğer her bileşenlerdir.

6. Grafikler:

- Her bir debi basamağının ekstraksiyon kuyusundan uzaklığın (yarı-logaritmik kağıda çizilmiş) veriye karşılık normalize edilmiş vakum (noktasal vakum izleme, noktasal vakum ekstraksiyonu)
- Hava akımı hızındaki her bir basamak için ekstraksiyon kuyusundaki hava akımı ve H₂O inç cinsinden uygulanan vakum
- Zamana karşı toplam uçucu organik bileşik (VOC) gaz fazında derişimi
- Zamana karşı yeraltısuyu yüksekliği

4.7 Pilot Test Alternatifi

Hem uzun vadede hem de ekonomik anlamda iyileştirme çalışması için pilot test yapılması idealdir. Fakat bazı durumlarda bu seçenek yapılabilir olmayabilir. O halde göz önünde bulundurulacak diğer seçenekler de vardır. Her ne kadar kurulum öncesi bir kaç ön test uygulamak kadar son raddede uygun maliyetli olmasalar da bu seçenekler de kabul edilebilir sonuç üretmeleriyle bilinirler.

Pilot test uygulanmasına ilk alternatif basitçe alanda geçici bir iyileştirme sisteminin kurulması ve iyileştirmeye anında başlanmasıdır. Teknolojideki ilerlemeler sayesinde daha çok yönlü, küçük TGE sistemleri üretildi ve bazıları kiralık kullanıma da sunulmaktadır. Bu daha küçük ve hareketli sistemler her hangi bir değişiklik yapılması gerektiğinde önceden görüp önlem almaya fırsat verirler.

Pilot teste ikinci alternatif ise alan karakteristiklerini tahmin etmek için genellenmiş referans bilgilerin kullanılmasıdır. Litoloji ve kabaca kirlenme uzamı bilindiğinde toprak geçirgenliği ve hava akımı tahmini için tane boyutu analizi bilgileri kullanılabilir. Bu tarz kabaca hesaplar kirlenme düzeyi küçük olan sahalarda iyi sonuç üretebilir. Bu yöntemin dezavantajları arasında, sahanın tahmin edildiği kadar homojen olmayabileceği ve farklı karakteristiklere sahip olabileceği durumu ve katmanlaşmış jeolojik koşulların görece belirgin zorluğu vardır. Bunlara ek olarak, eğer sistem hava salımı içeriyorsa havadaki derişimlerin tahminleri bizzat iyileştirme uygulamasından önce bulunmayacaktır.

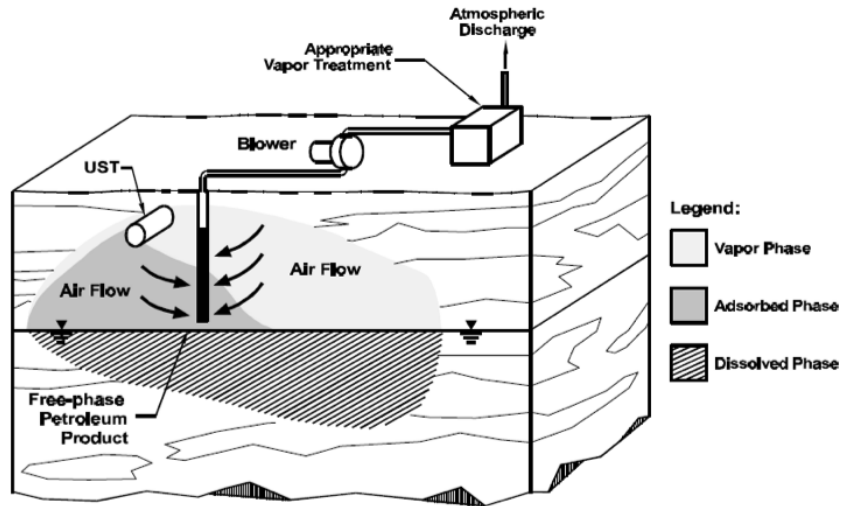

Şekil 4.9- Bir fan ile oluşturulmuş şema

Bu basamaklar ardışık bir şekilde de ardışıklık olmadan da uygulanabilir.

5 PERFORMANSIN İZLENMESİ

İzlemeler iyileştirmenin operasyonel fazında işlemin performansını değerlendirmek için, sistemi kapatıp toplamadan önce de temizleme ölçütünün sağlanıp sağlanmadığını test etmek için yapılır.

İzleme planında sistem başlangıcı ve kapanışta temizlik onaylanması bölümlerinde daha sık örnekleme olmalıdır. Operasyonel faz İzlemesinde sistem optimize olduktan sonra örnekleme sıklığı ve yoğunluğu azaltılabilir [USACE, 2002]

5.1 Operasyonel Faz İzlemesi

Rutin izlemeler sırasında dikkat edilmesi gerekli olan parametrelerin kısa açıklamaları aşağıda verilmiştir.

5.1.1 Kimyasal Parametreler

- İyileştirme prosesinin verimliliğinin ölçülmesi için toprak gazı kimyasal izlemeleri gereklidir. Bu toprak gazı münferit ekstraksiyon kuyularından ve toprak gazı sondalarından örneklenmelidir. Operasyonel faz sırasında arazi cihazları, alevle iyonizasyon dedektörü (FID) ya da foto-iyonizasyon dedektörleri olarak, sık ve sürekli toplam VOC ölçümleri için kullanılmaktadır. Yukarıda sözü edilmiş cihazlarla yapılan ölçümler tarama olarak nitelendirilmelidir. Bunun nedeni dedektörlerin seçici tepki vermemesi ve az sonra değinilecek diğer kısıtlamalardır [EPA, 2001].
 - Konvansiyonel bir foto iyonizasyon dedektör (PID) lamba kullanıldığında bir çok VOCların yüksek iyonlaşma potansiyelinden ötürü tespit edilemeyeceklerdir.
 - Gaz matris etkileri, nem, karbon dioksit ve alkanlar (özellike metan) PID tepkilerini düşürürler. Bununla birlikte eğer bağıl nem oldukça yükse ve % 100'e yakınsa dedektör üstünde yoğunlaşmalar olacağından hatalı pozitif tepkiler üretilecektir. Bu sinyal sensördeki elektrodların arasındaki akımın sızıntısından kaynaklanmaktadır [RAE System, 2013].
 - Bir çok VOC'taki yüksek halojen miktarı FID dedektörü kullanıldığında azımsanmış sonuçlar ve hatta hiç tespit edilememeye neden olacaktır.
- TGE sistemindeki ve olasılıkla münferit ekstraksiyon kutyularındaki VOC ve debi ölçümleri doymamış toprak bölgesinden kirletici kütlesi giderimini hesaplamak için kullanılmalıdır.
- Genel olarak çıkış gazı arıtımının öncesi ve sonrasında (karbon metal tüplreden önce ve sonra) hava salımı kontrol sisteminin verimliliğini değerlendirmek için kirletici derişimi ölçümleri yapılır.
- Yeraltısuyu kimyasal izleme: vadoz bölgede iyileştirme çalışmaları yeraltısuyu koşullarından bağımsız bir şekilde işletilmemelidir. Söz gelimi doymamış toprak kılcallılık eylemleri ve su tablası düzeyi dalgalanmaları ile yeniden kirlenebilir. Yeraltısuyundaki kirletici derişimleri de sıvı fazdan toprak gazına kütle transferini değerlendirmek için izlenmelidir.

5.1.2 Fiziksel Parametreler

- Toprak ve gaz sıcaklığı ölçümleri: Gaz sıcaklık verileri gaz kontrol sistemlerinin verimliliğini değerlendirmekte faydalı olabilir ve aşağıda tartışıldığı gibi debilerin normalize edilmesini sağlayabilir. Toprak sıcaklığı değerleri vadoz bölgede meydana gelen biyoyıkım (biodegradation) süreçleri için bir gösterge olabilir.
- Bağıl nem: nem içeriği gözeneklerde akışkan hareketlerini destekleyecek boşluğun hacmini azaltır. Bu yüzden yüksek nem düzeyleri vadoz bölge boyunca hava geçirgenliği ve hava akımını düşünebilir, aynı nedenden dolayı da toprak gazı izleme sonuçlarını etkileyebilir. Ayrıca, ayıklanan gazın bağıl nem değeri

fanı korumak için ve gaz emisyon kontrol sistemlerinin verimini artırmak için düşürülebilir (bağıl nemin %50'den fazla olduğu durumlarda aktif karbonun tutma kapasitesi ciddi ölçüde azalır.) Genelde buhar akımının bağıl nemi bir hava ısıtma sistemiyle düşürülebilir [USACE, 2002]. Çoğunlukla sistemle kurulmuş fan bu iş için gereken ısıyı getirmektedir. Buhar akımının ne düzeye kadar ısıtılacağı aktif karbon kullanımı sırasındaki izin verilen en yüksek sıcaklıkla sınırlıdır.

- Su düzeyleri: bu değerler vakum uygulaması sonucunda yükselme derecesini gözleyebilmek için ekstraksiyon kuyuları alanında ölçülmelidir. Özellikle su tablasındaki dalgalanmaları özel bir dikkat gösterilmelidir, çünkü bu değişimler katı, sıvı, gaz fazları arasında kirlenici kütle transferini artırabilir. Ayrıca su yükselmesi iyileştirme bölgesinde aşırı neme neden olarak aktif karbonun tutuculuk kapasitesini düşürebilir. Bu sorun nem ayırımını geliştirerek ve/ya yükselme ile gelen yeraltısuyu bizzat başka bir yere pompalayarak düzeltilebilir [USACE, 2002].
- Debi ölçümü: her bir kuyudaki debi verisi ile uygulanan vakum basıncı birlikte değerlendirildiğinde vadoz bölgenin hava geçirgenliği düzeyi hakkında fikir verebilir. Debi değerlerini standart sıcaklık ve basınca göre normalize etmek diğer çalışmalardaki verilerle karşılaştırma yapılabilmesi açısından oldukça önemlidir.
- Vakum / basınç ölçümleri: farklı noktalarda ve derinliklerde yapılan vakum ölçümlerinden alınan değerler hava akımı yollarının bir göstergesidir. Vakum ölçümlerinden elde edilen basınç değişimleri yatay ve dikey düzlemde hava iletkenliği tahminleriyle birleştirilerek gezinti süresi ve hız değerlendirmelerinde kullanılmalıdır [Truex, 2013].

5.1.3 Meteorolojik

Meteorolojik veri (yağmur, barometrik basıncı, hava sıcaklığı gibi) kaydedilmeli ve izleme sonuçlarının doğru yorumlanabilmesi için hesaba katılmalıdır.

- Yağmur: yağış olayları uçucu kirlenicilerin toprak boyunca taşınmasını sınırlandırarak TGE performansı ve toprak gazı izleme sonuçları üzerinde önemli etkiye sahip olabilirler. Bu yüzden ciddi bir yağıştan sonra (yarım inç [1.27 cm] ya da daha fazla yağmuru takip eden 24 saatlik periyot) toprak gazı örnekleme yapılmamalıdır. Bu bekleme süresi toprak drenaj eğrileri baz alınarak belirlenmelidir [CalEPA, 2015].
- Barometrik basınç: Atmosferik basınçtaki dalgalanmalar yüzeyaltı ve atmosfer arası gaz geçişini tetikler. Doymamış bölgedeki atmosferik basınçtaki doğal dalgalanmalar sonucunda oluşan gaz hareketlerine "barometrik pompalama" denmektedir. Atmosferik basınç düştüğünde gazlar yüzeyaltından yukarıya, atmosfere doğru hareket ederler. Tam tersi durumda da, atmosferik basınç arttığında temiz hava toprağa aşağıya doğru ilerlemeye başlar [Kuang, 2013] Barometrik basınçtaki değişimlerin atmosferik gazların taşınmasına olan etkisi sistem kapatma sırasında daha da belirgin olabilir.

5.2 Temizlemenin Onaylanması ve Sistemin Kapatılması

Genellikle iyileştirme prosesinin amacı farklı çevresel matrisler için önceden belirlenmiş kalite standartlarının elde edilmesidir. TGE için nihai kapatma ölçütü genellikle topraktaki yasal ya da risk bazlı belirlenmiş derişim standartlarına ulaşım ulaşmamaya bağlıdır. Bununla birlikte toprak örnekleme hem maliyetlidir hem de potansiyel olarak bozucu etkiye sahiptir. Ayrıca tutarlı bir biçimde kalıntı kirlenme miktarını tahmin etmek çok ciddi boyutlarda ve sayıda toprak örnekleme gerektirir, çünkü toprak karışmamış, heterojen bir ortamdır [USACE, 2002]. Bu nedenle büyük ölçekli bir toprak örnekleme çalışmasına başlamadan önce diğer parametrelere (kanıt çeşitlerine) bakılarak, gerekli izlemeler yapılarak iyileştirme süreci takip edilebilir ve iyileştirme hedeflerinin ulaşılabilirliği gibi gözüküp gözükmediği değerlendirilebilir.

5.2.1 Temizleme Onaylanması ile Değerlendirilebilecek Olası Kanıt Kaynakları

- toprak örnekleme: pahalı ve bozucu Temizlemenin teyit edilmesi ve sistemin kapatılması için sonucu kullanılacak toprak örnekleme topraktaki derişim dağılımının heterojenliğine ve VOC için toprak örneklemedeki belirsizliklere dikkat etmelidir [USACE, 2002].
- Ayıklanan gazda derişim eğilimi: Ekstraksiyon kuyularındaki VOC derişimi kirletici kütlesi giderimine bir ölçer görevi görür ve iyileştirme sürecinin de bir göstergesidir. Genellikle bir kaç aylık operasyondan sonra veriler çok hızlı bir düşüş eğilimi göstermeye başlar, ki bunun sonucuna derişim asimptotik düzeylere ulaşmaktadır (bkz. Şekil 5.1 ve Şekil 5.2) Bir çok vakada asimptotik koşullara ulaşılması karar verici nokta olma özelliğindedir ve teknolojinin performans sınırları ile havalandırma sisteminin kapanması zamanlarını belirtir. Fakat çıkış gazında düşük asimptotik gaz derişimi gözlenmesi kirlenmiş topraktan kirletici maddenin kütlece gideriminde katedilen yolu göstermede gerekli fakat kendi başına yeterli olmayan bir göstergedir. Çıkış gazında asimptotik derişim görüşmesi havalandırma sistemi tasarımı (söz gelimi kuyular arası aralık) ya da operasyon koşulları (söz gelimi debi) ve ayrıca ya da birlikte gaz transfer hızındaki kısıtlamalarından dolayı olabilir [EPA, 2001].

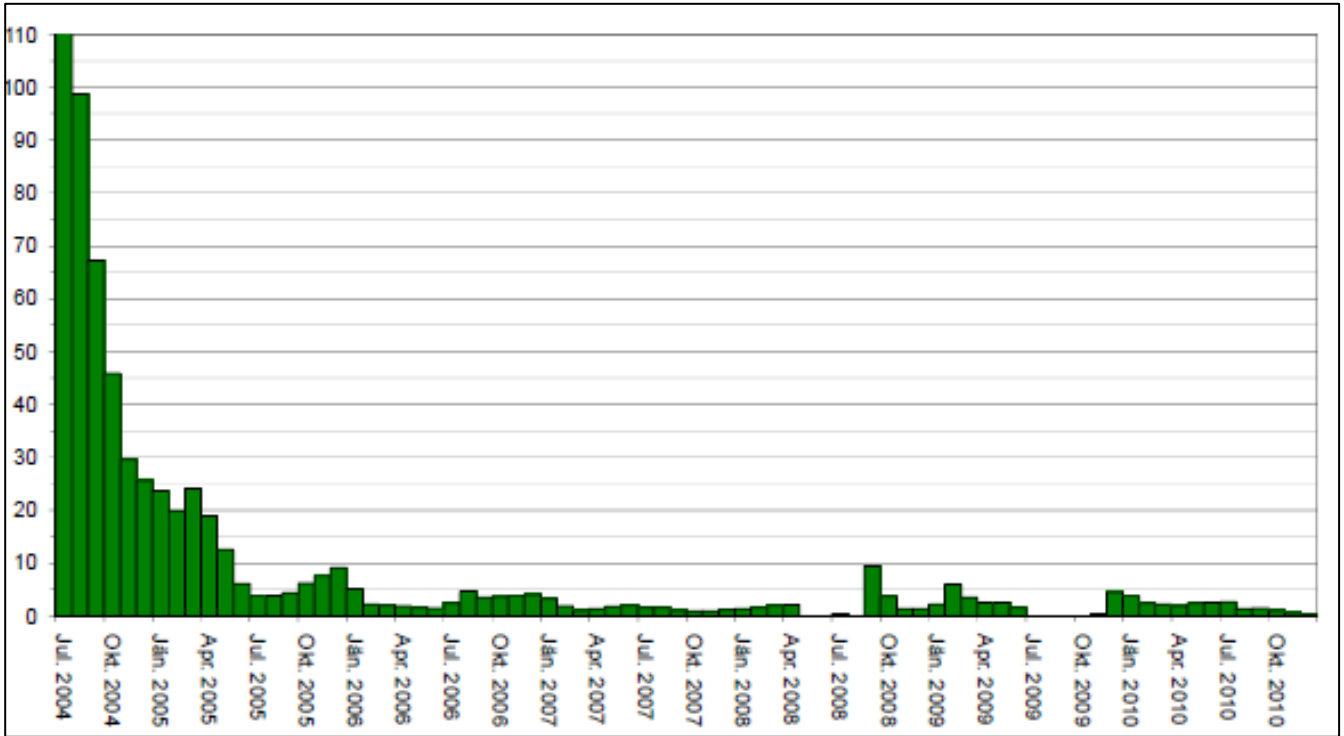

Şekil 5.1 – Kirletici kütlesi giderimindeki eğilimler (TGE): kg PCE/gün

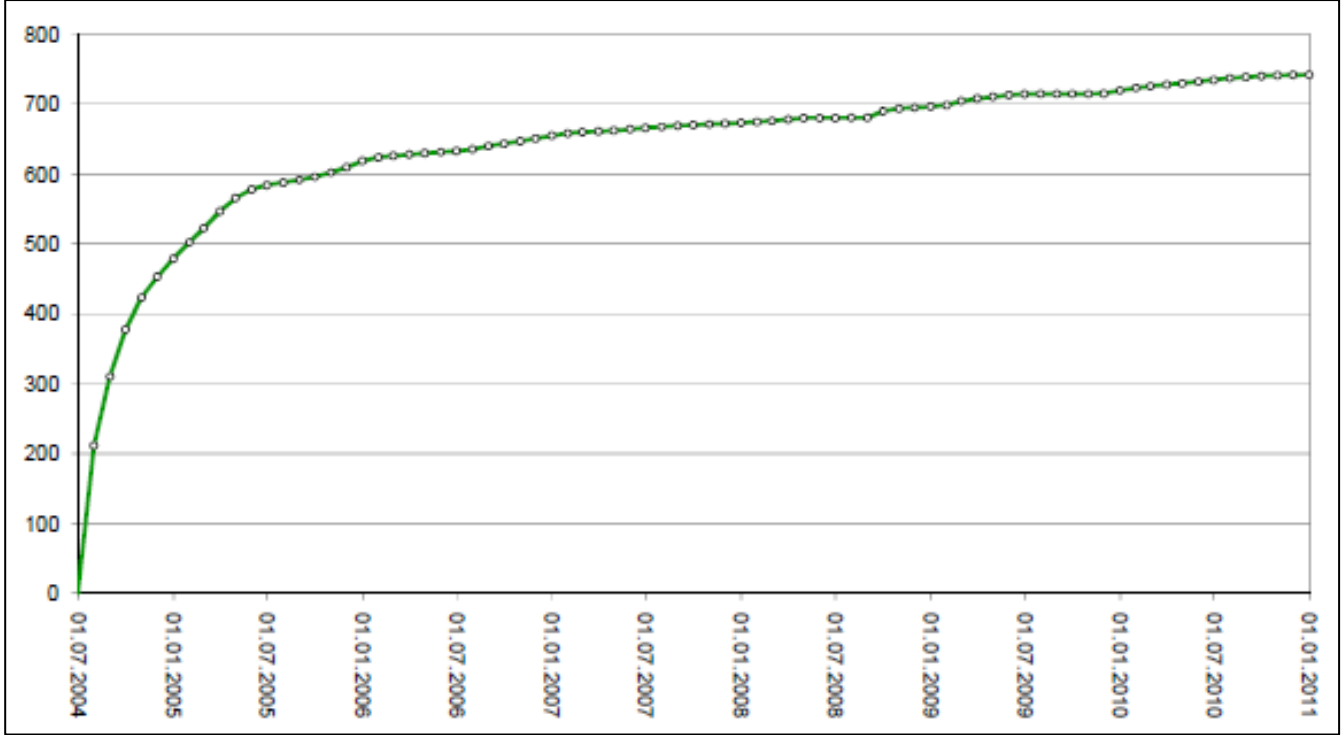

Şekil 5.2 – Kirlenici kütlesi giderimindeki eğilimler (TGE): kg PCE (toplam zaman)

- Gaz ekstraksiyonu işlemi kuyuların yakınında ya da arasında iyi yıkanan toprak bölgelerinde oldukça etkilidir, bu yüzden toprakta bu denli iyi şekilde gazı ayıklanamayan bölgelerde çok ciddi miktarlarda kirlenici miktarı varken yukarıda söz edilen kuyu-yakın bölgelerde VOC derişiminde düşük asimptota çok daha erkenden ulaşılabilir.
- Ayıklanan gazda asimptotik derişim düzeylerine ulaşılması toprak havalandırmasında hız kısıtlamaları olduğunu da ima ediyor olabilir. Eğer ekstraksiyon hızı toprak medyasında farklı fazlar arasında (katı, sıvı ve gaz) difüzyon hızından daha fazla olursa topraktaki ve sudaki bütün kirleniticiler giderilmeden ayıklanmış gazda derişim düşüşü görülebilir [USACE, 2002].
- Toprak gazı izlemesi: toprak gazının örneklenmesi görece daha ucuzdur ve hava daha karışık bir medya olduğu için elde edilecek veri de daha büyük bir alandan entegre olacaktır. Bu yüzden toprak gaz ölçerlerde VOC izlemesi yapmak büyük olasılıkla daha önce a) ve b) de tanımlanmış iyileştirme sürecini izleme yöntemlerinden daha verimli ve etkilidir. Toprak gazı örnekleme standart bir prosedür izlenerek yapılmalıdır. Bu prosedür izleme sonuçlarının üstündeki arazi koşullarının etkisini (litoloji, nem gibi) ve örnekleme parametrelerinin etkisini (örnekleme debisi, hacmi gibi) göz önünde bulundurmalıdır. Toprak gaz sondaları ayrıca ekstraksiyon kuyusundan uzakta, iyileştirilmesi zor yerlere de kurulmalıdır. Böylece kalıntı kirlenici miktarı izlenebilecektir.
- Geri geliş (riband ya da rebound): Operasyonel fazda genel olarak kütle transfer hızındaki sınırlar nedeniyle (açlık etkisi) ve civar havayla seyrelme nedeniyle toprak gazındaki VOC derişiminde düşüş görülmektedir. Sonuç olarak TGE sistemi kapatıldığında bu fazlardan difüzyon yeniden başlayarak VOC derişimlerinde artışlaa neden olabilir. Bu fenomen genelde riband/geri gelme olarak tanımlanır ve arıtım etkililiğinin güvenilir bir göstergesi olarak düşünülebilir. Minimum riband ya da ribandın durağan bölgelerde dahi sistemin durdurulmasının ardından bir süre sonra hiç olmaması olasılıkla oradaki kirlenici kütlesinin temizlendiğine işaret etmektedir. Deneye ulaşmak için gereken zaman periyodu kirlenici ve toprak tipine özeldir. Kumlu topraklar genelde bir kaç hafta içinde dengeye ulaşırken çok

katmanlı yapıda topraklar için bu süre bir kaç aydan fazla olabilir. Yıllık denge (geri gelme) tesleri önerilmektedir [AFCEE, 2001].

5.2.2 Kapanış Örnekleme için Önerilen Prosedür

TGE için nihai kapatma ölçütü genellikle topraktaki hedeflenmiş derişim standartlarına ulaşip ulaşmamaya bağlıdır. Bununla birlikte daha önce de tartışıldığı gibi toprak örnekleme hem maliyetli hem de potansiyel olarak çevreyi bozucu etkisi olduğu için büyük ölçekli bir toprak örnekleme kampanyası başlatmadan önce diğer parametrelere (kanıt çeşitleri) bakarak iyileştirme çalışması sonuç verebilecek gibi görünüyor mu kontrol edilmelidir. Böylelikle temizleme onaylanması için aşağıda verilmiş 3 adımda doğrulama prosedürü önerilmektedir:

- Operasyonel fazda hedef toprak gazı derişiminin elde edilmesi;
- Sistem geçici olarak kapatıldığında hedef toprak gazı derişiminin elde edilmesi;
- Toprak örnekleri sonuçları ile temizleme ölçütlerinin karşılaştırılması.

6 SONUÇLAR

Toprak Gazı Ekstraksiyonu (TGE) doymamış bölgedeki uçucu organik bileşiklerin derişiminin düşürülmesi için arazide saha üstünde yapılmaya uygun bir teknolojidir.

TGE genel olarak uçucu organik bileşiklerin gideriminde etkili bulunmuştur ve yarı-uçucu bileşiklerin de başka yöntemlerle gideriminde destek olabilecek durumdadır. Belli başlı bazı projelerde kloroetilenler (PCE ve TCE gibi) gibi klorlü çözücüler ya da petrol gibi uçucu petrol ürünleriyle kirlenmiş sahalarda TGE yöntemi sıklıkla diğer iyileştirme yöntemleriyle birlikte uygulanmaktadır.

6.1 Verimlilik, Avantajlar ve Dezavantajlar

TGE'nin etkinliğini etkileyen kilit faktörler:

- toprağın hava geçirgenliği (bu parametre toprak boyunca hareket edebilecek hava ve buharın miktarını etkiler);
- toprak yapısı ve katmanlaşması (bunun önemi ekstraksiyon sırasında topraktaki hava akımının yönünü ve eğilimini etkilemesindedir);
- toprak nemi (gözenekler arası gas akımını kısıtlayabilmektedir);
- yer altı suyu tablasının derinliğidir.

Temel avantajları:

- Bilinen verimlilik, kolay elde edilebilen araç-gereçler, kolay kurulum;
- Saha etkinliklerinin az düzey bozukluk oluşturması: TGE sistemlerin tasarımı oldukça esnek olup herhangi bir saha koşuluna uyum sağlayabilir çünkü kuyu inşaatı düşük müdahaleli ve görece adapte olabildi bir işlemdir.
- Kısa arıtma süreleri (optimum koşullarda 6 ay - 2 yıl arası süreler): her ne kadar arıtım süresi saha koşullarına bağlı olsa da diğer yöntemlere göre görece kısadır, genelde bir kaç ay ile bir kaç yıl arasında değişir ve çok uçucu bileşiklerde % 90'a kadar giderim sağlayabilirken yarı uçucularda bu giderim 30-40 % bandında olmaktadır.
- Uçucu bileşikleri gidermede kullanılabilecek diğer yöntemlere kıyasla kolay uygulanabilir, görece ucuz ve fiyat-performans oranı iyidir (rekabet edebilen maliyet: 15-60 €/ton kirlenmiş toprak)
- Serbest ürünleri olan alanlara da uygulanabilir ve diğer teknolojilerle birleştirilebilir. Toprak katmanlarına uygulanan vakum yeraltındaki gaz taşınımını kontrol eder ve yapıları ve yeraltı altyapılarını yanıcı ya da toksik uçucu bileşiklerden korur.

Ana kısıtlamalar:

- %90'dan daha yüksek derişim giderim verimleri elde edilmesinin zorluğu;
- Düşük geçirgenliği olan ve heterojen olarak katmanlaşmış topraklarda bu yöntemin oldukça düşük verimlilik sergilemesidir.

6.2 TGE uygulamasının Operasyonel Kontrolü

Teknolojinin uygulanabilirliğinin değerlendirilmesi için yapılması gereken temel ön kontrollerin arasında doymamış toprak bölgesinin geometrik, litolojik, hidrojeolojik karakteristiklerinin tanımlanması ve su tablasındaki herhangi bir artış ve azalışın göz önünde bulundurulması/değerlendirilmesi vardır. Arıtılacak doymamış bölgenin 3 boyutta sınırları göz önünde bulundurulduğu zaman odadaki toplam kirletici miktarının iyileştirme çalışmasından önce tahmin edilmesi oldukça yararlıdır. Bu şekilde kirletici giderim hızları karşılaştırılabilir ve zamana göre değişen giderim verimleri belirlenebilir, aynı zamanda uygulamanın sonlandırılması da toplam kirletici giderimine bakarak karar verilebilir.

İnşaat aşamasında doğrulanacak parametreler arasında temel olanlar etki yarıçapı (R) ve arıtım yarıçapı (ROT)'dır. Kontrol edilmesi gereken ve operasyona etkisi olacak diğer parametreler ise şunlardır: yeraltısuyu düzeyinde dalgalanmalar, hava toplama sistemleri, ayıklanmış gazların atmosfere salınmadan önce arıtılmasının veriminin zamanla değişimi. Operasyon boyunca sistem kontrol altında olmalıdır. Bu aynı zamanda arıtmanın sonlandırılması için uygun zamanı belirlemek adına önemlidir.

TGE ile iyileştirme girişiminin sonuna yaklaştığında işbu girişimin olası kapanışını değerlendirmede ilerlemek için bazı kontroller gereklidir. Bu noktaya kadar uygulayıcı (operator) 'nın bir dizi bilgiyi değerlendirmesi ve ilgili Otoritelere gerekli analizler yapıldıktan sonra çevresel durum hakkında rapor sunması gereklidir. Aynı zamanda uygulayıcı iyileştirmenin yeterince yapıp yapılmadığına ilişkin yapabileceği çapraz kontroller için de gerekli unsurları Otoritelere teslim etmelidir.

KAYNAKÇA

Belgeler alfabetik sıraya göre atfedilmiştir: [Yazar/lar, Yıl, Başlık, #]

- AFCEE, 2001. United States Air Force Environmental Restoration Program: Guidance on Soil Vapor Extraction Optimization. Air Force Center for Environmental Excellence, Brooks Air Force Base, Texas. Last accessed July 17, 2012, at <http://www.dtic.mil/docs/citations/ADA392205>;
- Air Sparging: Technology Transfer and Multi-Site Evaluation ESTCP Project ER-9808, freely downloadable at <https://www.serdp-estcp.org/content/download/3734/59418/file/ER-9808%20Design%20Paradigm.pdf>
- Analysis of Selected Enhancements for Soil Vapor Extraction, September 1997, EPA-542-R-97-007, consulted at <https://clu-in.org/download/remed/sveenhmt.pdf>
- Baker, R. S., ve Wiseman, J. T. 1992. Importance of vadose zone monitoring during soil vapor extraction pilot studies. Proceedings: International Symposium on In Situ Treatment of Contaminated Soil and Water. Cincinnati, OH. February 3-6, 1992. Air and Waste Management Association, pp. 26-41.
- Ball, R., ve Wolf, S. 1990. Design considerations for soil cleanup by soil vapor extraction. Environmental Progress. 9(3):187-90
- Breckenridge, R. P., Williams, J. R., ve Keck, J. F. 1991. Characterizing Soils for Hazardous Waste Site Assessments. Ground-Water Issue, EPA/540/4-91/003, Office of Research and Development, Office of Solid Waste and Emergency Response.
- CalEPA, 2015: California Environmental Protection Agency, Advisory – Active Soil Gas Investigations, Department of Toxic Substances Control.
- Davies, S. H. 1989. The influence of soil characteristics on the sorption of organic vapors. The Workshop on Soil Vacuum Extraction. R.S. Kerr Environmental Research Laboratory, Ada, OK. April 27-28, 1989.
- DiGiulio, D.C., ve R. Varahan. 2001a. Limitations of ROI testing for venting design: description of an alternative approach based on attainment of a critical pore-gas velocity in contaminated media. Ground Water Monitoring & Remediation 21(1): 97-114.
- Engineering Issue: Soil Vapor Extraction (SVE) Technology, February 2018, EPA/600/R-18/053, consulted at https://cfpub.epa.gov/si/si_public_file_download.cfm?p_download_id=538425&Lab=NRML.
- Farallon consulting, Final capital industries plant 4soil vapor extraction pilot study work plan freely downloadable at <https://www.farallonconsulting.com/wp-content/uploads/2020/09/2019-Final-SVE-Pilot-Study-WP.pdf>
- Freeze, R. A., ve Cherry, J. A. 1979. Groundwater. Prentice Hall, Englewood Cliffs, NJ. 604 pp.
- FRTR Technology Screening Matrix: Thermal Treatment, March 2020, consulted at <https://frtr.gov/matrix2/section4/4-9.html>.
- Interim Final. Directive 9234.2-25, September 1993. OSWER. Washington, DC. 26 pp.
- Johnson, Jeffrey, DeWitt, Christopher B., Wolfe, Bryan, and Mark Garman. 1999. Moisture and Ammonia-Enhanced Bioventing in Arid Environments, abstract, in "Proceedings of the Fifth International Symposium on In-Situ and On-Site Bioremediation, San Diego, CA, April 19-22, 1999"
- Jury, W. A., Winer, A. M., Spencer, W. F., and Focht, D. D. 1987. Transport and transformations of organic chemicals in the soil-air-water ecosystem. Reviews of Environmental Contamination and Toxicology. 99:120-64.
- Kuang vd., 2013 Review on airflow in unsaturated zones induced by natural forcings. Water Resour. Res., 49 (2013), pp. 6137-6165
- Minnesota Pollution Control Agency Voluntary Investigation and Cleanup Design Criteria and Reporting Requirements Guidance Document #17 (Vapor Extraction, Air Sparging), freely downloadable at <https://www.pca.state.mn.us/sites/default/files/vic-gd17.pdf>
- PNNL. SVE System Operation, Transition, and Closure Guidance (2013)
- RAE System, 2013 The PID handbook. Theory and Applications of Direct-Reading Photoionization

Detectors, ISBN: 0-9768162-1-0

- Soares, A.A., Pinho, M.T., Albergaria, J.T. vd. Sequential Application of Soil Vapor Extraction and Bioremediation Processes for the Remediation of Ethylbenzene-Contaminated Soils. *Water Air Soil Pollut* 223, 2601–2609 (2012).
- Soil Vapor Extraction (SVE) treatment technology resource guide, September 1994, EPA/542-B-94-007, freely downloadable at https://www.epa.gov/sites/production/files/2015-08/documents/sve_tt_res_guide.pdf
- State of Florida, Soil Vapor Extraction Pilot Test Guidance <https://floridadep.gov/sites/default/files/BPSS12B-SVEGuidance.pdf>
- Suthersan, S. S. (1999). Soil vapour extraction. In *Remediation engineering: Design concepts* (pp. 27–88). Boca Raton: Lewis Publisher Inc.
- The SVE Pilot Test, consulted 16/03/2021 at <https://www.enviroequipment.com/blog/soil-vapor-extraction-sve-pilot-test>
- Truex, M. J., D. J. Becker, M. A. Simon, M. Oostrom, A. K. Rice, ve C. D. Johnson. *Soil Vapor Extraction System Optimization, Transition, and Closure Guidance*, PNNL-21843. U.S. Department of Energy, Washington, DC, 2013.
- USACE. 2002. *Engineering and Design: Soil Vapor Extraction and Bioventing*. EM 1110-1-4001, U.S. Army Corps of Engineers, Washington, D.C. Last accessed July 17, 2012, at http://publications.usace.army.mil/publications/eng-manuals/EM_1110-1-4001_sec/toc.htm
- USAF. *Guidance on Soil Vapor Extraction Optimization* (2001)
- US EPA. 2001. *Development of Recommendations and Methods to Support Assessment of Soil Venting Performance and Closure*. EPA/600/R-01/070, U.S. Environmental Protection Agency, Washington, D.C.
- USEPA. 1991h. *Description and Sampling of Contaminated Soils, A Field Pocket Guide*. EPA 625/12-91/002, Center for Environmental Research Information, Cincinnati, OH.
- USEPA. 1989c. *Laboratory Investigation of Residual Liquid Organics from Spills, Leaks, and the Disposal of Hazardous Wastes in Groundwater*. EPA/600/6-90/004. New Mexico Institute of Mining and Technology, Socorro, NM.
- USEPA. 1993g. *Guidance for Evaluating the Technical Impracticability of Ground-Water Restoration*.



European Union Network for the Implementation
and Enforcement of Environmental Law

Annex 1

Soil Vapour Extraction – Case studies

IMPEL Project no. 2020/09



1. Contact details - CASE STUDY: SVE n.1

1.1 Name and Surname	Aline Jordens, Mathieu Petitjean, Hatem Saadaoui, Jan Haemers
1.2 Country/Jurisdiction	Belgium
1.3 Organisation	Haemers Technologies
1.4 Position	Innovation Engineer
1.5 Duties	R&D
1.6 Email address	innovation@haemers-tech.com
1.7 Phone number	+32 2 786 39 43



2. Site background

2.1 History of the site

The site is located in the military airbase of Biên Hòa, Dong Nai, Vietnam. During the US-Vietnam War (1955-1975), millions of litres of herbicides were dropped over Vietnam: The Rainbow agents. Those Rainbow Agents were sprayed throughout the Operation Ranch Hand to clear thick jungle, by defoliating crops and forest. Bien Hoa Airbase was a joint operating base for the South Vietnam Air Force and the United States Air Force. According to the U.S. Department of Defense, 98 000 barrels of Agent Orange, 45 000 barrels of Agent White and 16 000 barrels of Agent Blue were stored at Bien Hoa Airbase [1].

As a consequence, the Biên Hòa airbase is currently the largest dioxin hotspot in Vietnam [2].

Nowadays, it is estimated that between 408,500 and 495,300 m³ of dioxin-contaminated soil and sediment are present in the site [3]. This is almost 4 times the volume of the last airbase that underwent treatment (Danang).

More than four decades after the Vietnam War ended (in 1975), the stability and bioaccumulation of dioxins still affect the inhabitants. Measures had to be taken to improve living conditions for residents, starting with the remediation of dioxin contaminated soil. In 2018, at the request of the Government of Vietnam (GVN), the U.S. Government agreed to cooperate on dioxin remediation at Bien Hoa Airbase Area. Haemers Technologies was invited to perform a pilot remediation in the process of the technology selection for the full-scale project.

[1] DOD. 2007. Presentation made at the Second Agent Orange and Dioxin Remediation Workshop, Hanoi, Vietnam, June 18-19, 2007. Co-sponsored by U.S. Department of Defense and Vietnam Ministry of National Defense.

[2]: USAID, FACT SHEET: DIOXIN REMEDIATION AT BIEN HOA AIRBASE AREA, consulted 16/12/2020, <https://www.usaid.gov/vietnam/documents/fact-sheet-dioxin-remediation-bien-hoa-airbase-area>

[3] USAID. 2016. Environmental Assessment of dioxin contamination at Bien Hoa Airbase

2.2 Geological setting

There are mainly two types of soils that need to be remediated : low-humidity soil as well as high-humidity muds from swamp-like areas.





2.3 Contaminants of concern

Agent Orange was proven to cause severe health issues, including birth defects, neurological problems and cancers. Agent Orange is a mixture of 2,4-dichlorophenoxyacetic acid and 2,4,5-trichlorophenoxyacetic. Traces of dioxins were also found in some Agents. Indeed, dioxin 2,3,7,8-Tetrachlorodibenzo-p-dioxin (2,3,7,8-TCDD) can be formed by condensation of 2,4,5-trichlorophenol during 2,4,5-trichlorophenoxyacetic synthesis.

Hereafter is shown the breakdown of a sample taken from the site (Contaminated sample column). The “treated sample” column refers to the sample after a lab test. The increase in secondary contaminants after treatment is most likely due to the sample heterogeneity.

	<i>Contaminated sample</i>	<i>Treated sample</i>	<i>Unit</i>
Dry matter	94,9	99,7	% (dry matter mass)
2,3,7,8-Tétra CDD	2800	630	ng/kg DM
1,2,3,7,8-PentaCDD	14	84	ng/kg DM
1,2,3,7,8,9-Hexa CDD	13	27	ng/kg DM
1,2,3,6,7,8-HexaCDD	20	42	ng/kg DM
1,2,3,4,7,8 -Hexa CDD	3,5	7,5	ng/kg DM
1,2,3,4,7,8,9-Hepta CDD	99	46	ng/kg DM
Octa CDD	450	200	ng/kg DM
1,2,3,7,8 Penta CDF	1,7	3,2	ng/kg DM
2,3,4,7,8-Penta CDF	1,2	2,8	ng/kg DM
2,3,7,8-Tétra CDF	75	28	ng/kg DM
1,2,3,7,8,9 - Hexa CDF	<1,0	<1,0	ng/kg DM
2,3,4,6,7,8 - Hexa CDF	2,3	1,9	ng/kg DM
1,2,3,4,7,8 Hexa CDF	1,5	2,0	ng/kg DM
1,2,3,6,7,8 Hexa CDF	<1,0	1,4	ng/kg DM
1,2,3,4,7,8,9 -Hepta CDF	<5,0	<5,0	ng/kg DM
1,2,3,4,6,7,8 -Hepta CDF	9,4	<5,0	ng/kg DM
Octa CDF	<10	<10	ng/kg DM
I-TEQ-PCDD/F-OTAN/CCMS (lower limit)	2820 ⁴	685	ng/kg DM
I-TEQ-PCDD/F-OMS 1998 (lower limit)	2830 ⁴	727	ng/kg DM
I-TEQ-PCDD/F-OMS 2005 (lower limit)	2830 ⁴	726	ng/kg DM
I-TEQ-PCDD/F-OTAN/CCMS (upper limit)	2820 ⁵	685	ng/kg DM
I-TEQ-PCDD/F-OMS 1998 (upper limit)	2830 ⁵	727	ng/kg DM
I-TEQ-PCDD/F-OMS 2005 (upper limit)	2830 ⁵	727	ng/kg DM



2.4 Regulatory framework

Haemers Technologies was invited by the Vietnam Government to perform a pilot project in the context of the technology selection for the Bien Hoa airbase remediation led by USAID and GVN.

The soil concentration limits after treatment have been defined as following:

- Industrial use: 1,200 ppt
- Urban area: 300 ppt
- Sediment: 150 ppt

3. Pilot-scale application in field

3.1 Extraction system

The treatment proposed by Haemers Technologies is a thermopile (ex-site thermal treatment). The thermopile is a small pilot-scale pile of 500 tons (11m x 14m at its base). In a thermopile, the soil is heated by conduction until it reaches the temperature of volatilization of the pollutants (a process known as thermal desorption). The vapours are then extracted to be treated. In the pile are installed 15 heating tubes and 13 exchanger tubes that transfer thermal energy to the soil. The vapours are extracted by 15 perforated tubes that are connected to a 15 kW blower in order to generate a low but constant depression sucking the gasses out. The typical depression generated is in the order of -0.2 mbar.

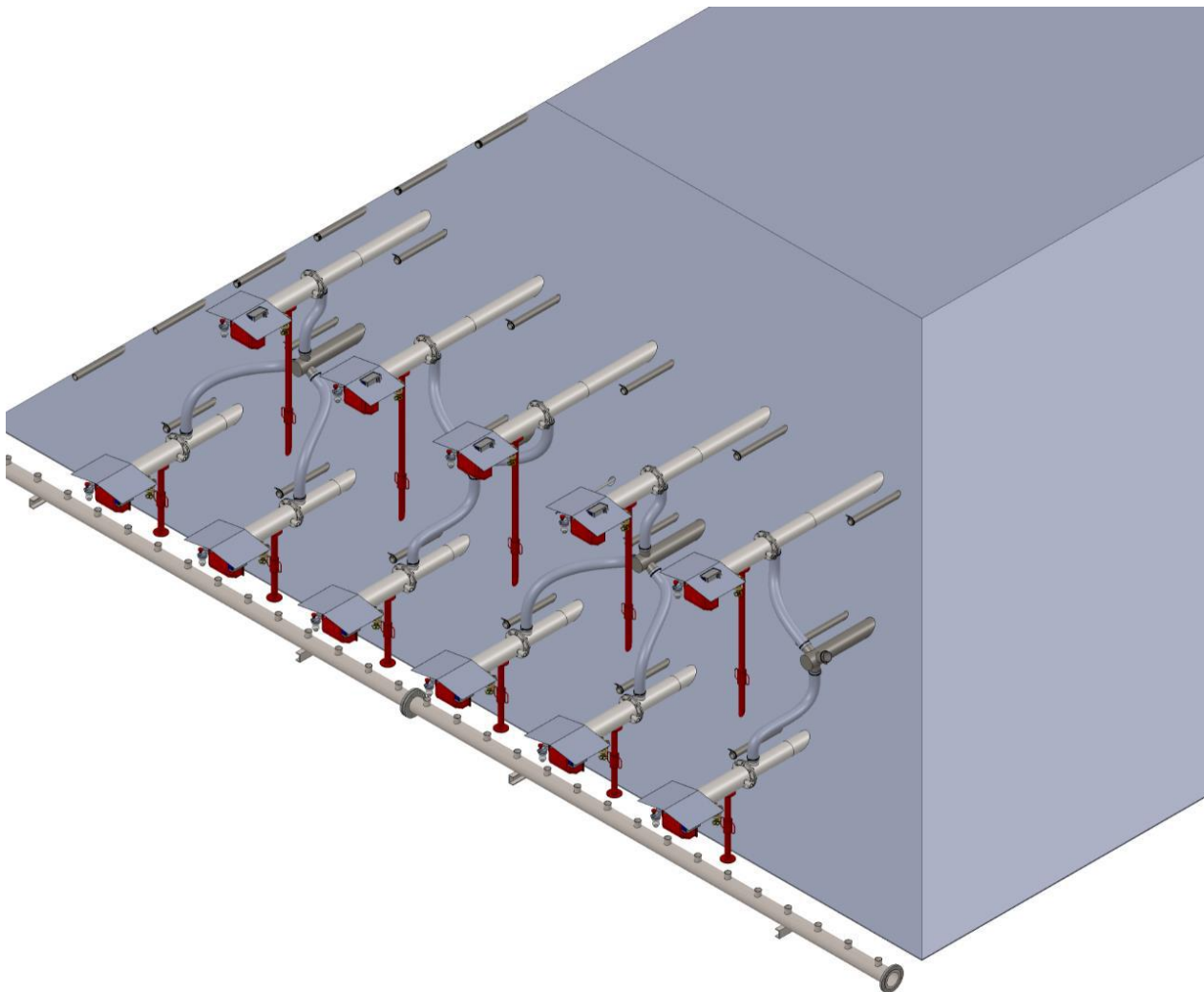



3.2 Injection system

In thermal desorption treatment, there is no injection system. The gases are generated when the contaminants and the water are vaporized due to the thermal energy transfer.

3.3 Radius of influence

The treatment is effective on the whole pile. Lab tests have shown that if the soil reaches 350°C and that the temperature is maintained for at least 5 days, the target treatment concentrations are met.

The main factor of influence is the interdistance between heating wells in the pile, but they only affect the **heating time**, i.e. the time needed to reach 350°C. The treatment effectiveness is unchanged.

In this case, the soil vapour extraction wells are approx 1.2m apart. This short range is not the actual radius of influence of each well, as this radius varies in the course of the treatment. As temperature increases, soil is drying out, affecting the permeability to vapours. Therefore, the actual radius of influence of each pipe is likely much larger than 1.2m, even if the applied negative pressure is very low (in the order of 0.2mbar). E The high density of soil vapour extraction wells is commanded by the necessity to collect all vapours despite the low negative pressure and avoid fugitive emissions.

3.4 Off gas Treatment

The contaminated vapours are sucked from the pile and transit through the Vapor Treatment Unit (VTU). Contrary the approach taken by USAID at Danang which used activated carbon, Haemers Technologies uses a Thermal Oxidizer in order not to leave any waste requiring further treatment.

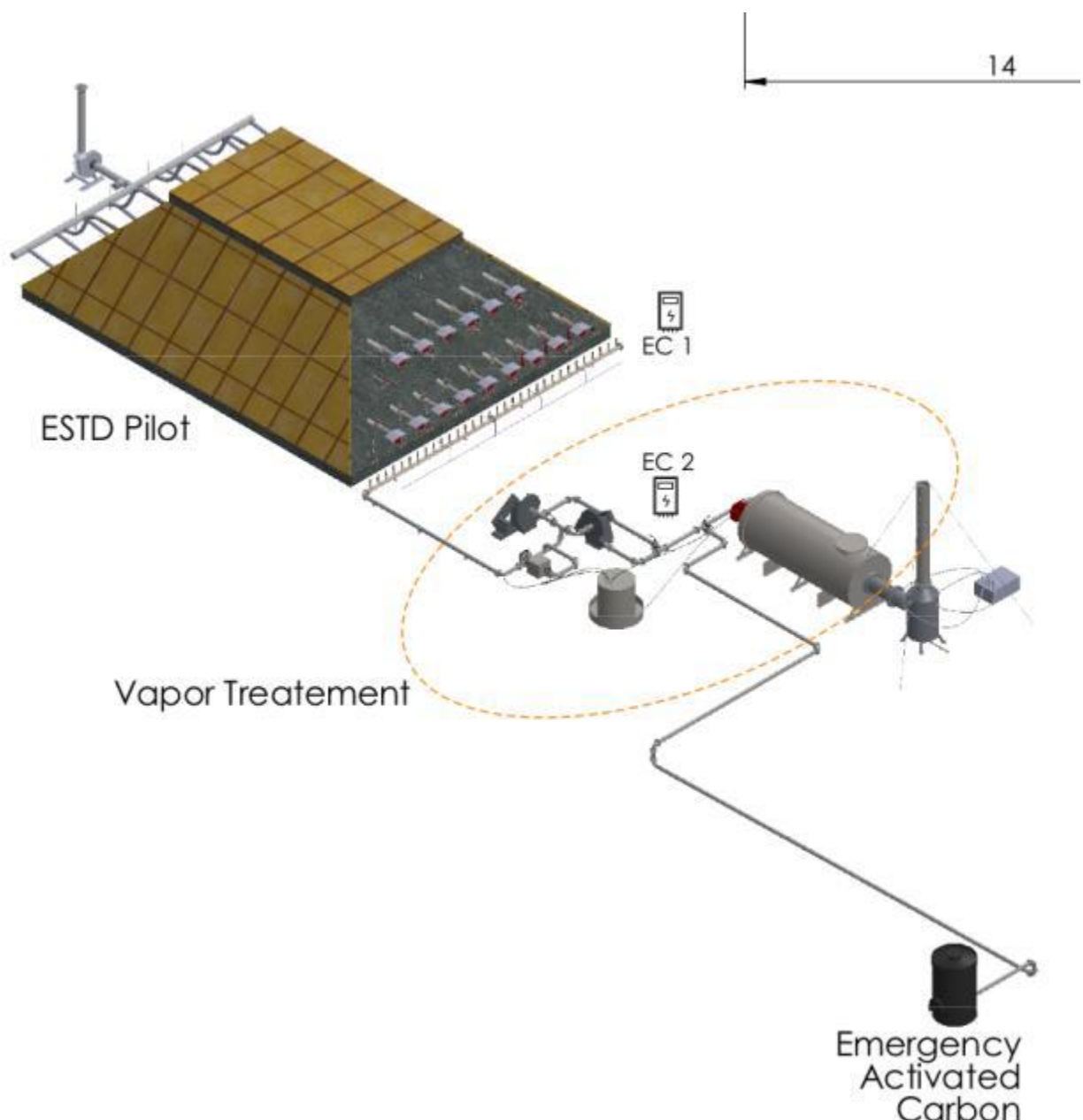

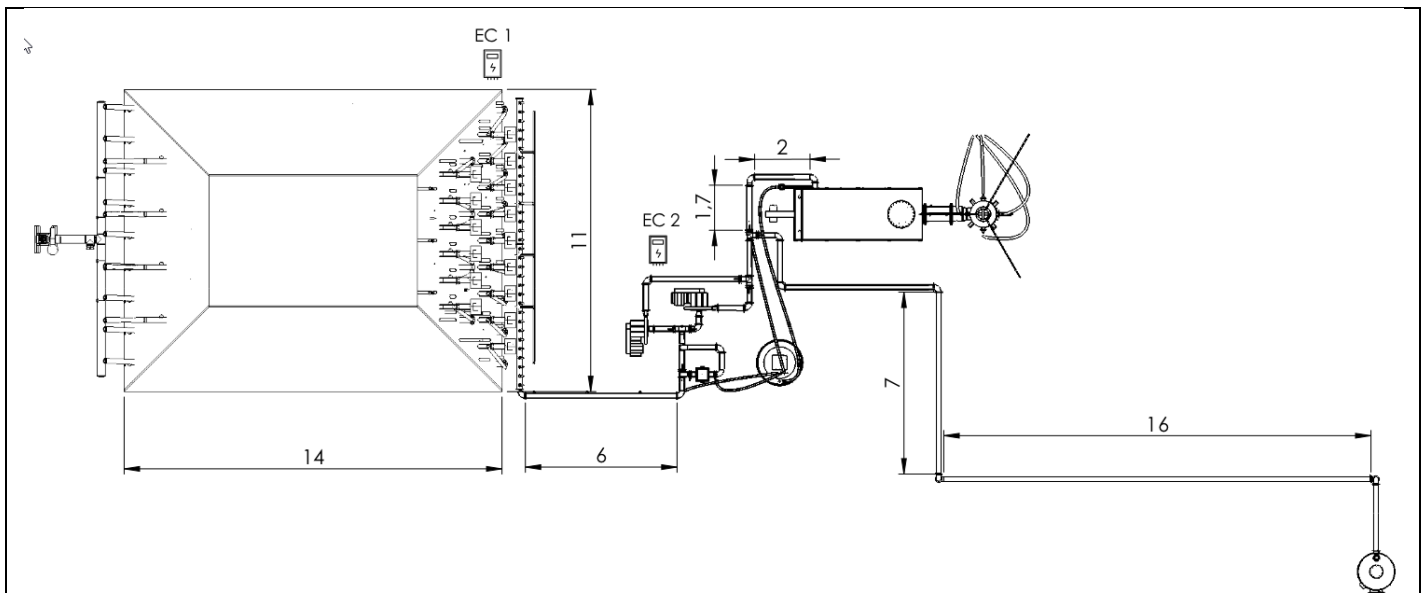

Before entering the Thermal Oxidizer, the vapours may circulate through an Arsenic filter if needed.

The vapours are then directly incinerated in order to destroy all PCDD and PCDF's. Proper oxidation guarantees compliant air emissions. It has to be noted that condensation will certainly happen along the network. To reduce liquid formation, the network is thermally insulated. Nevertheless, the liquid formed can be reinjected in the Thermal Oxidizer. To reach a destruction rate efficiency over 99,99%, the following criteria must be fulfilled in the oxidation chamber [4][5]:

1. Temperature of minimum 1100°C (preferably 1200°C)
2. Oxygen content of min 6% (preferably 10%)
3. Residence time of minimum 1 second (preferably 2 seconds)
4. High Turbulence ($Re \gg 2500$).

It is well known that dioxin compounds reformation can happen in the cooling phase, in a temperature range between 200°C and 500°C. Dioxins can be reformed in the presence of oxygen, chlorine (Cl_2) and hydrocarbons [6]. Other parameters such as presence of dust and/or presence of metals, can also promote the dioxins/furans formation. To avoid the reformation process, the vapours are directed towards a cooling quench tower to a temperature below 180°C before being released in the atmosphere.

In case of issue, a back-up activated carbon tank is also present.

[4] Gao, Y. &. (2015). Assessment of Reynolds Averaged Navier–Stokes Modeling of Scalar Dissipation Rate Transport in Turbulent Oblique Premixed Flames. *Combustion Science and Technology*, 18

[5] Jacob E. Temme, T. M. (2015). Measurements of Premixed Turbulent Combustion Regimes of High Reynolds Number Flames. 53rd AIAA Aerospace Sciences Meeting (p. 21). Kissimmee, Florida : AIAA SciTech Forum.

[6] Buekens, A. (2001). Dioxins from thermal and metallurgical processes: recent studies for the iron and steel industry,. *Chemosphere* 42, 729-735.



3.5 Control parameters

Of course, the dioxin content in the soil is analyzed before and after treatment to assess the treatment effectiveness. However, thermal desorption has already been implemented at the Danang airport and has been proved to be effective against dioxin contamination.

The parameters that are continuously monitored during the treatment are the following:

- The temperature at the coldest points in the thermopiles
- The emissions at all chimneys to guarantee regulatory compliance
- The depression in the pile to ensure proper extraction
- The temperature in the Thermal Oxidizer
- The oxygen content in the Thermal Oxidizer
- The temperature of gases at the quench tower output to avoid dioxin reformation

4. Full-scale application

The pilot project was interrupted by the Covid-19 pandemic and the full-scale application has not started yet.

5. Enhancements to SVE

5.2 Any other enhancement

The Thermal Oxidizer in combination with a heat exchanger can be used to improve the overall thermal efficiency of the thermal desorption process by recovering energy and preheating the combustion air and the vapours themselves.

6. Post treatment and/or Long Term Monitoring

6.1 Post treatment and/or Long Term Monitoring

Post treatment monitoring consists of soil analysis.

Monitoring is based on the extracted vapours as well as temperatures inside the soil.



7. Additional information

7.1 Lesson learnt

The biggest hurdle in this project was the heavy burden of procedures and authorizations required to perform the actual projects, due to the high sensitivity of the site with respect to its danger and history, as well as the military control over all operations.

7.2 Additional information

Even if the project is not finished, it has already been established that thermal desorption is effective against dioxin contamination. The addition of a Thermal Oxidizer improves the Danag process, given that:

- Soil is indeed treated according to standards
- The exhaust gas after thermal oxidation are compliant (no reformation of dioxin)
- No solid nor liquid waste is generated, not needed further off-site disposal

7.3 Training need

Training needs are specific both the heating and extraction system, as well as to the Health and Safety measures to be taken on site.

Additional communication is required given the nature of the contaminants in order to fully inform operators and local community about the safety of the process for their own health.

Glossary of Terms

Term (alphabetical order)	Definition
VTU Vapor Treatment Unit	VTU Vapor Treatment Unit
ppt	part-per-thousand

1. Contact details - CASE STUDY: SVE n.2

1.1 Name and Surname	Jean Rhone, Mathieu Petitjean, Alain Duchene, Hatem Saadaoui, Jan Haemers
1.2 Country/Jurisdiction	Belgium
1.3 Organisation	Haemers Technologies
1.4 Position	Innovation Engineer
1.5 Duties	R&D
1.6 Email address	innovation@haemers-tech.com
1.7 Phone number	+32 2 786 39 43

2. Site background

2.1 History of the site

The site is located in the North of France. It used to be a manufacturing site producing different chemicals, acids and catalysers. Many soil and water investigations were carried out from 1998 to 2015. They showed a presence of impacts of many pollutants in multiple spots of the 0.32 km². The results of those analyses were not different from classic industrial pollution and the main pollutants found were hydrocarbons, BTEX, PAH and heavy metals. The site is located next to agricultural fields and the soil is mainly made of backfills and loam. Once the analyses confirmed the concentrated polluted spots, a “Plan de Gestion” (remediation plan) was drafted, leading to various site uses and different remediation target concentrations.

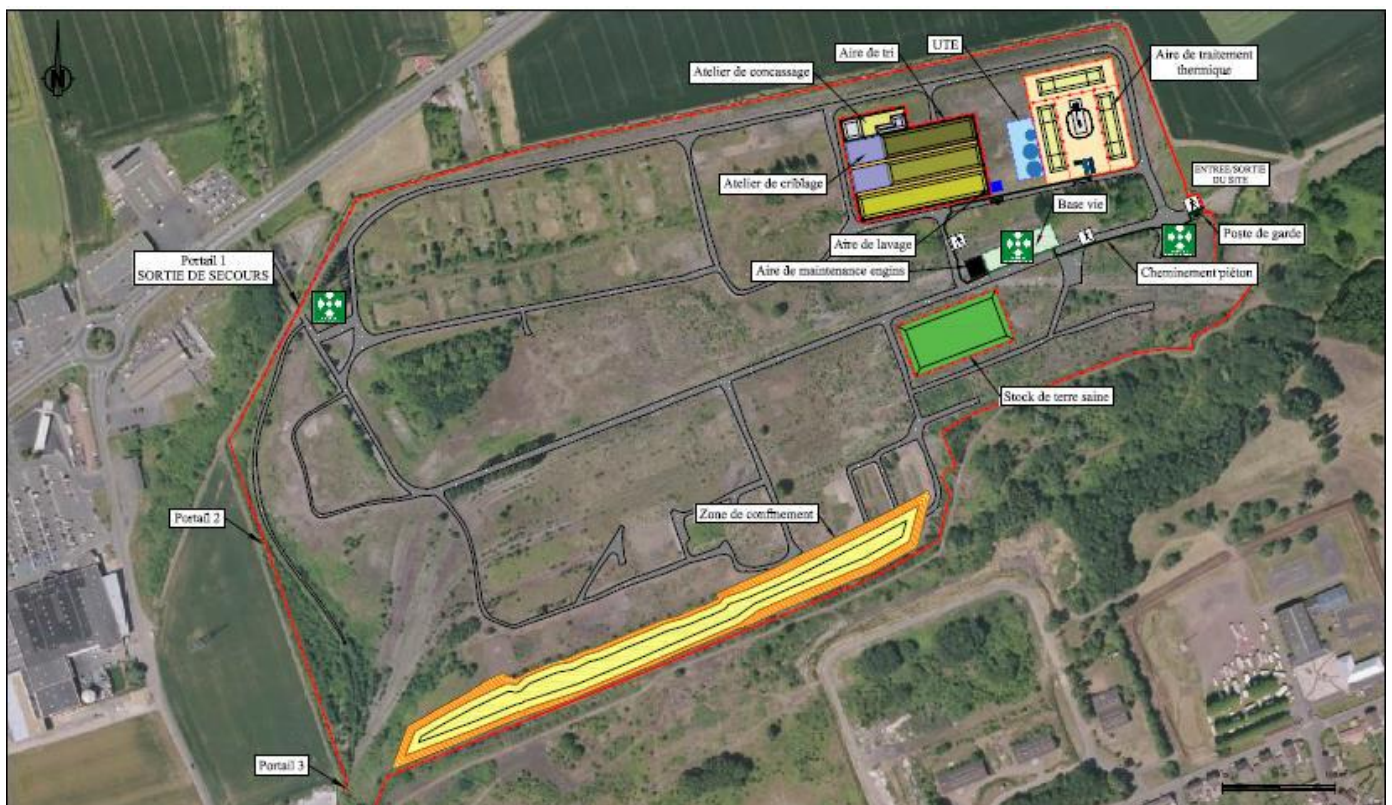



2.2 Geological setting

The whole site covers about 34 hectares. It is located between a commercial area and an agricultural area. Indeed, agricultural fields are present at North and East of the site. The main issue with high concentrated spots on a large area is the difficulty to treat all the spots onsite and therefore an Ex-Situ Thermal Desorption (ESTD) was selected. Soils with hydrocarbons concentrations higher than the remediation target were excavated and stored in a single location and eventually erected in several polluted soil piles.

Item	Value	Units
Average Soil Density	1.8	kg/m ³
Average Porosity	0,3	V_v/V_T
Moisture Content	0,24	$\frac{W_{water}}{W_{soil}}$

The thermal treatment area is isolated from groundwater with a waterproof geotextile placed at a depth of 0.4 m. The site's topography was designed to have no accumulation of rainwater in the area. Slight slopes were designed and a rainwater collecting system was constructed to send the rainwater to the water treatment plant.



2.3 Contaminants of concern

The contaminants are the COCs identified hereafter:

Contaminant Type	Number of samples	Average concentration (mg/kg DM)	Targets (mg/kg DM)	
C ₅ -C ₁₀			Clay/loam	250
			Backfill	100
C ₅ -C ₄₀	218	4145,5	Clay/loam	2000
			Backfill	1000
BTEX	218	1,16	Benzene	1,5
			Toluene	5
			Ethylbenzene	10
			Xylene	40
HAP	218	30,3	50	

Soils with hydrocarbons concentrations higher than the remediation target were excavated and stored in a single location and eventually erected in several polluted soil piles. The treatment area was chosen to be able to run 2 piles simultaneously, with a third one in mobilization/demobilization.

Because of the client's concern about Mercury (Hg) soil concentration, a classic ESTD treatment was chosen with the addition of an ad-hoc Vapor Treatment Unit situated at in the middle of the treatment area.

2.4 Regulatory framework

The site has been owned by different companies over the course of the last century. A prefectural order was issued in 2015 for the soil remediation in the context of a remediation plan (one commercial and activity area and one park and walking area). The owner issued Golder Associates to be the prime contractor. The contractor chosen by Golder Associates was Seché EcoService, which partnered with Haemers Technologies.

3. Pilot-scale application in field

No pilot-scale application was performed

4. Full-scale application

4.1 Extraction system

The treatment proposed by Haemers Technologies is a rotating thermopile (ex-situ thermal treatment). Each pile consists of 2000m³ of polluted soil. In the pile are installed 75 heating tubes and 25 exchanger tubes that transfer thermal energy to the soil. The vapours are extracted by perforated tubes that are connected to a blower in order to generate a low but constant depression sucking the gas out. The typical generated depression is in the order of -0.2 mbar.

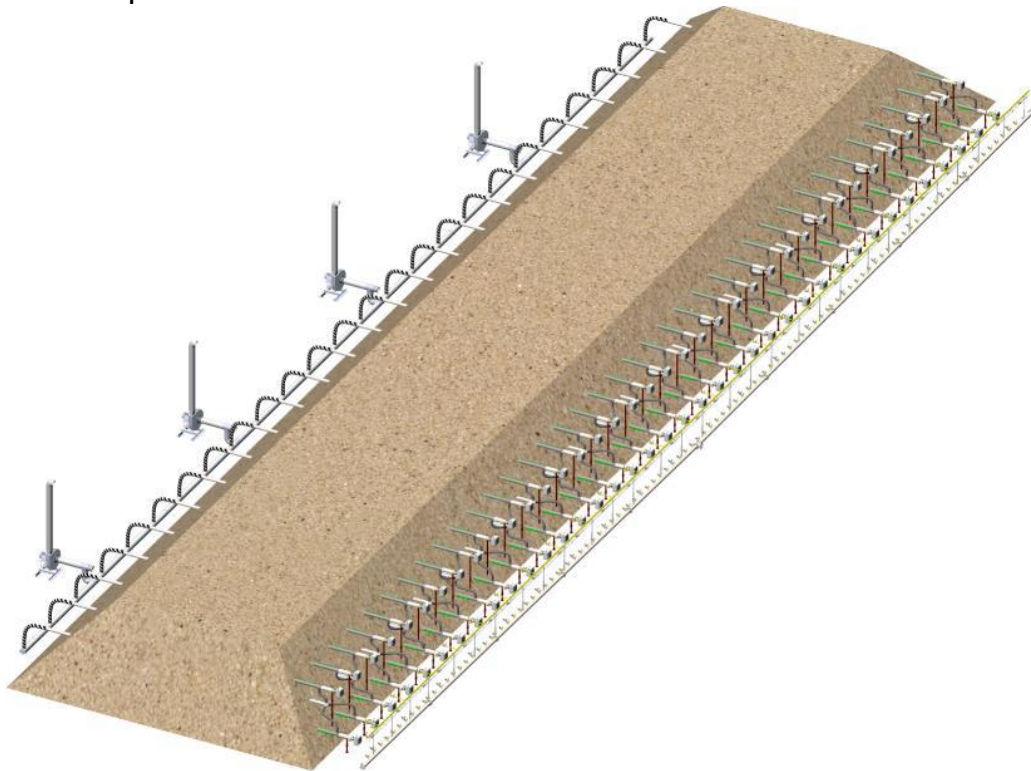



4.2 Injection system

In thermal desorption treatment, there is no injection system. The gases are generated when the contaminants and the water are vaporized due to the thermal energy transfer.

4.3 Radius of influence

The treatment is effective on the whole pile. Lab tests have shown that if the soil reaches 200°C and that the temperature is maintained for at least 3 days, the target treatment concentrations are met.

The main factor of influence is the interdistance between heating wells in the pile, but they only affect the heating time, i.e. the time needed to reach 200°C. The treatment effectiveness is unchanged.

In this case, the soil vapour extraction wells are approx 1.5m apart. This short range is not the actual radius of influence of each well, as this radius varies in the course of the treatment. As temperature increases, soil is drying out, affecting the permeability to vapours. Therefore, the actual radius of influence of each pipe is likely much larger than 1.5m, even if the applied negative pressure is very low (in the order of 0.2mbar).

The high density of soil vapour extraction wells is commanded by the necessity to collect all vapours despite the low negative pressure and avoid fugitive emissions.

4.4 Off gas Treatment

The contaminated vapours are sucked from the pile and transit through the Vapor Treatment Unit (VTU). The VTU is able to handle the off gases of two simultaneous piles. This way, a rotating schedule was implemented where two piles are in treatment while the third is dismantled and the next one is built.

The VTU aims to treat the contaminant's vapours coming from the piles' treatment to stay within national environmental release norms. The VTU is composed of various elements designed to achieve the treatment. Most of the VTU's installation is focused on the contaminant's vapours suction and condensation. The other part is focused on direct treatment through adsorption or thermal oxidation.

The following Figure presents the contaminated vapours flow from the Pile to the VTU.

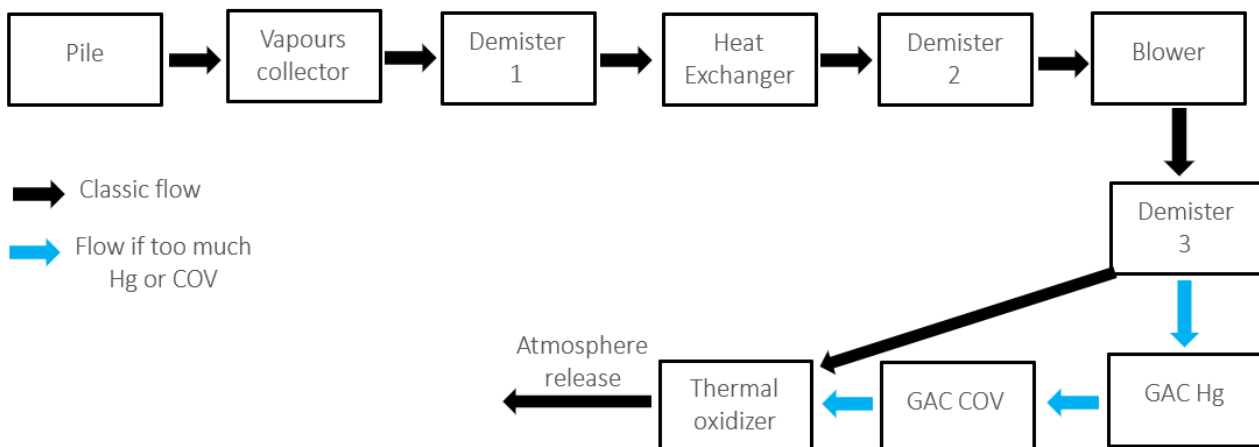

The VTU consists of three demisters and a heat exchanger. The non-condensable vapours (mainly air and light hydrocarbons) are sent to a thermal oxidizer (operating at 820°C), with a residence time of 2 seconds. If high concentration of Mercury is detected, the vapours are routed to a sulphured Activated carbon filter.

The process is partly duplicated to be able to continue the thermal treatment during maintenance of each VTU element. A Programmable Logic Controller was used to automate the switch between the two line.

The next figure will show the duplicated VTU scheme.

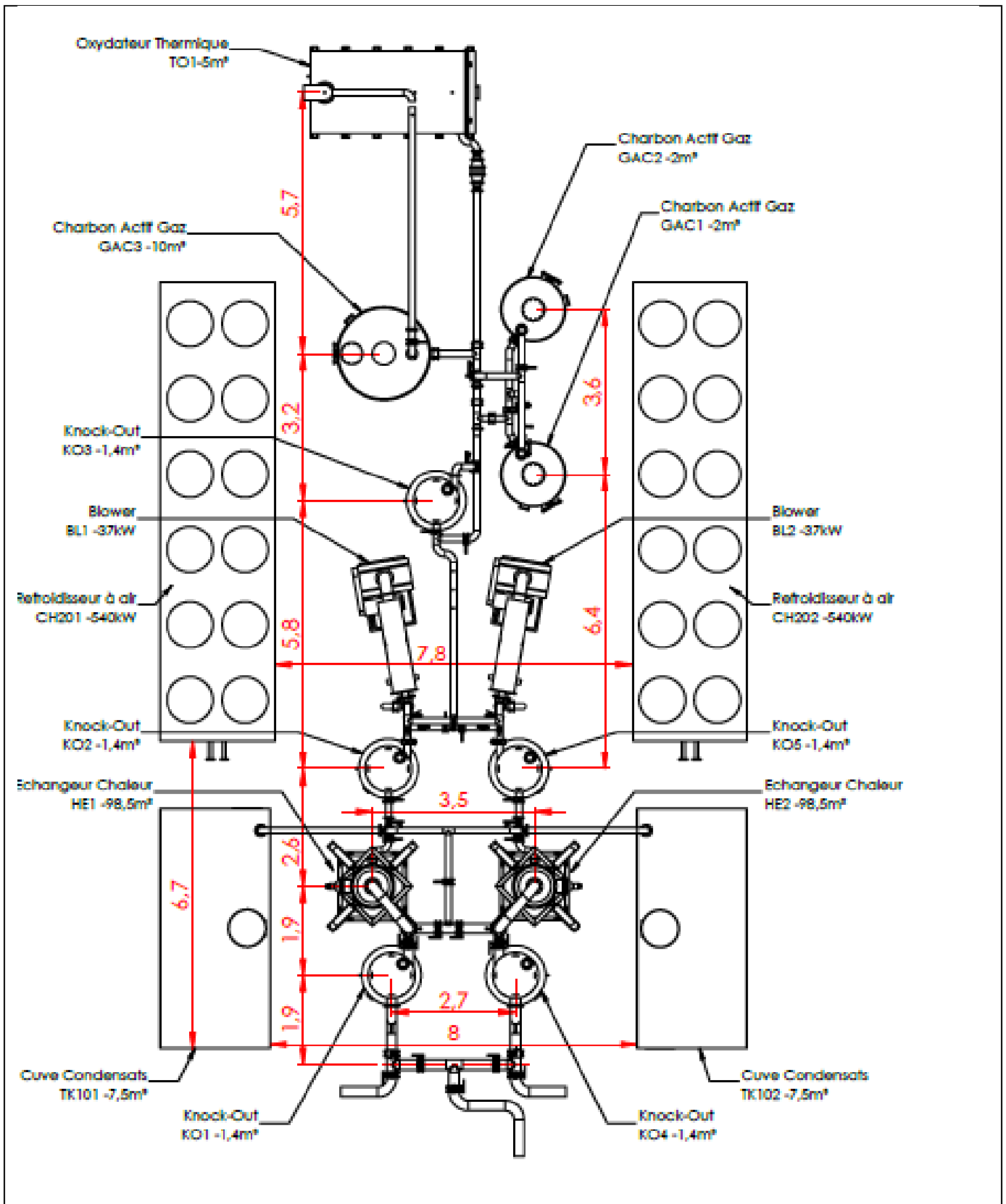

Vapours collector

One 5" vapour collector was built for each pile. It was made of 10 sections of 6 meters

each. Each collector has a low cant in order to collect the condensates. The collector is connected to an underground tank. Vapour flexible are connected to the collector as shown in the next picture.



The underground tank is connected to an 8" vapour collector that goes to the VTU as shown in the next picture.



Water collected on the underground tanks is sent to the condensate tanks.

Demisters

A demister equipment is made to remove liquid droplets from gases.

Condensates are collected at the bottom of the tank and sent to be treated by Seché ES. One demister is placed at the VTU entry in order to remove the droplets formed on the 8" collector. One is then placed after the heat exchanger to remove the droplets formed during the vapours' cooling. The final demister is placed after the blower. Indeed, pressure changes in the blower can also create droplets. The aim was to remove humidity before entering the thermal oxidizer.

Heat exchanger

Installation of one heat exchanger was mandatory for two main reasons: vapour cooling before the blower, water removal using condensation process. In a tubular exchanger, vapours pass through copper thin pipes and gets cool down by water passing between the pipes. Each of the heat exchanger has a 98.5 m² exchange surface. Water is then cooled down using a dry air cooler (540 kW). Glycol was added to the water to prevent freezing during winter. The next pictures show the heat exchanger and the dry air cooler.



Blower

The blower is the most important part of the VTU. Its aim is to depressurize the pile by vacuuming the air and the contaminated vapours. Each of the two blowers was designed to vacuum two piles simultaneously. Thus, each blower has a maximum flow capacity of 3,200 m³/h. They are set using one frequency regulator. The maximum acceptable temperature at the input is set to 80°C. The next picture shows one blower.



GAC Hg

Mercury traces were found in previous soil analysis. Exxon suggested Haemers Technologies to provide a solution in order to prevent any mercury atmospheric releases. Two sulphurous activated carbon tanks of 3 m³ and one Hg analyser (VM-3000) were added to the VTU. The aim was to analyse the vapours after the blower in order to know the mercury concentration. If the concentration was over the norms, an electrovalve redirected the vapour flow to the activated carbon. Another sampling point was placed after the activated carbon in order to assess the mercury removal. The chosen activated coal has an apparent density of 0.63 kg/l and a sulphur concentration of 13-16%. The following picture shows the mercury tanks.

GAC COV

Vapours should be treated through the thermal oxidizer. However, in case of thermal oxidizer breakdown, an activated coal tank of 10 m³ was added. In case of thermal oxidizer breakdown, the flow was redirected to this new tank. The outlet was connected to the thermal oxidizer's chimney. An activated coal with the following specifications was chosen: apparent density of 0.475 kg/l and US Standard Mesh granulometry of 4*8. It was chosen to remove COV from the vapours. The following picture shows the tank and its chimney connection.



Thermal oxidizer

The thermal oxidizer is the key equipment for the vapour treatment. Indeed, the other equipment (except for the GACs) were not chosen for the hydrocarbons removal but mainly to remove the water from the vapours for a better thermal oxidation. Its aim was to remove the pollutants from the vapours and to release clean gases. A residency time of minimum 2 seconds was calculated in order to have an efficient pollutants thermal oxidation. The thermal oxidizer is 5 m³ and has a 3 meters chimney. It is designed to resist to a maximal temperature of 1,000 °C. A 850 kW burner is connected to the thermal oxidation chamber and fuelled with gas. The burner power is regulated depending on the temperature inside the thermal oxidizer. The normal conditions to have the best pollutants removal efficiency were fixed from 780°C to 820°C. The next picture shows the thermal oxidizer.





4.5 Control parameters

The VTU operation is monitored by a Programmable Logic Controller (PLC). The following key data is monitored:

- Vapor temperatures at all steps of the process
- Pile depression to ensure proper aspiration of the vapours
- Pressure points at all steps of the VTU
- Mercury content after the blower
- Gas emissions at the Thermal Oxidizer chimney (COV, CO, NO_x, PM2.5, PM10, PCDD, HCl, HF, SO₂)

6. Post treatment and/or Long Term Monitoring

6.1 Post treatment and/or Long Term Monitoring

Post treatment monitoring consists of soil samples analysis.

7. Additional information

7.1 Lesson learnt

Special care needs to be taken when operating in countries where below-zero temperatures can be reached. In the case of this project, glycol needed to be mixed with water in the cooling sections.

- It can be beneficial to perform more advanced analysis than the ones provided by the end customer. In particular, the presence of acidic compounds is not relevant per se to the remediation but can damage the equipment.



7.2 Additional information

The success of remediation is determined by the compliant pollutants content in the soil after treatment as well as compliant emissions throughout the treatment.

Glossary of Terms

Term (alphabetical order)	Definition
VTU	Vapor Treatment Unit

1. Contact details - CASE STUDY: SVE n.3

1.1 Name and Surname	Luca Sacilotto
1.2 Country/Jurisdiction	Italy
1.3 Organisation	Ramboll Italy S.r.l.
1.4 Position	Senior Managing Consultant
1.5 Duties	Project management of contaminated sites and brownfield assessments for industries; development and implementation of complex remedial projects addressing a wide variety of contaminants in several hydrogeological settings.
1.6 Email address	lsacilotto@ramboll.com
1.7 Phone number	+39-3341319233



2. Site background

2.1 History of the site

The site extends over a surface of around 90,000 m², of which around 82,000 m² is paved or covered by buildings (buildings cover an area around 41,000 m²).

The plant began the production of freezers and refrigerators for food preservation in 1967, production which is still ongoing even if at a reduced rate. The contamination of the site was discovered in 2009 during site characterization activities, and exceedances of the CSC have been identified in deep soils (depth > 1 m bgl) for organochlorinated compounds (vinyl chloride, 1,2-Dichloroethane, Trichloroethylene, 1,2-Dichloropropane), and in groundwater for the following compounds:

- Non-Volatile Metals: Iron, Manganese;
- inorganic compounds: Nitrite, Sulphate;
- BTEX: Toluene, Benzene;
- chlorinated aliphatic compounds: Tetrachlorethylene, Trichloroethylene, Vinyl Chloride, Chloroform, 1,2-Dichloroethane, 1,1-Dichloroethylene, 1,2-Dichloroethylene, 1,2-Dichloropropane, 1,1,2-Trichloroethane.

Furthermore, local areas of buried wastes were found at the site, and removed during subsequent intervention, but it cannot be excluded that additional buried wastes are still present.

2.2 Geological setting

Only the shallow portion of soil and groundwater, till a depth of about 15 m b.g.l., was investigated during the site characterization. The subsoil is formed by alluvial deposit formed by interbedded sandy and silty layers as indicated below, overlaying a silty aquitard (see figure below). At a regional scale, a thin semiconfined aquifer contained in a conglomerates formation is present at 70 m b.g.l.

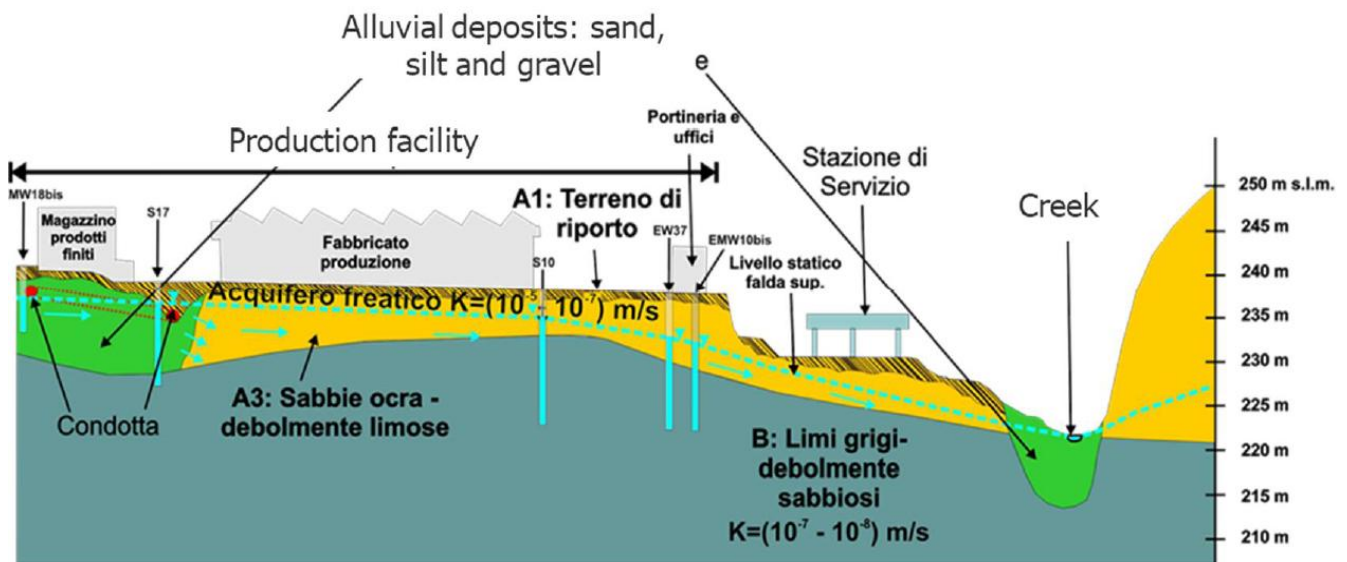

The figure represents the hydro-geological cross-section of the site along the groundwater flow main direction (North-East to South-West).

During site characterization, shallow groundwater levels were ranging between 2 and 9 m b.g.l. (on average 4 m b.g.l.), with flow direction mainly from the upgradient hill (North, North-West) to South, South-Est, towards a Creek; however, groundwater flow at the N-E corner of the facility is affected by the presence of an intubated stream existing at the northern portion of the facility with direction from N-E to S-W, generating a local depression of the groundwater table. Backfilling materials used in the past in earth moving activities for underground installation of the intubated stream appear to be characterized by a low permeability, even if presence of more permeable alluvial materials (sand and gravel) is documented along the pipe at depths between around 8 and 11 m b.g.l. Average groundwater gradient was estimated equal to 3% and hydraulic conductivity (k) ranges between 10^{-6} (North-West side) and 10^{-8} m/s (North-Est side), with an average value of 5×10^{-7} m/s.

2.3 Contaminants of concern

Soil:

- vinyl chloride: 0.42 ÷ 0.45 mg/kg
- 1,2-Dichloroethane: 7 ÷ 672 mg/kg
- Trichloroethylene: 20 ÷ 43 mg/kg
- 1,2-Dichloropropane: 27 ÷ 154 mg/kg

Groundwater:

Non-Volatile Metals:

- Iron: 3.1 ÷ 41,400 µg/l
- Manganese: 0.89 ÷ 18,500 µg/l

BTEX:

- Toluene: 0.05 ÷ 200 µg/l
- Benzene: 0.053 ÷ 56 µg/l

Chlorinated aliphatic compounds:

- Tetrachlorethylene: 0.05 ÷ 38 µg/l
- Trichloroethylene: 0.05 ÷ 31,000 µg/l
- Vinyl Chloride: 0.031 ÷ 410 µg/l
- Chloroform: 0.018 ÷ 69 µg/l
- 1,2-Dichloroethane: 0.018 ÷ 4,800,000 µg/l
- 1,2-Dichloroethylene: 0.054 ÷ 22,000 µg/l
- 1,2-Dichloropropane: : 0.019 ÷ 89,000 µg/l



2.4 Regulatory framework

Clean-up goals for soil and groundwater were defined in the Risk Assessment, and are included in the on-going remedial plan, approved in 2012 (the updated approval in 2017 did not modify them).

According to Italian regulation, although the remedial targets are defined on a Risk Assessment basis inside the facility (SSTLs or CSR), groundwater quality at the end of remedial action must comply with regulatory limits (CSC, much more conservative than calculated SSTLs) at the downgradient boundary of the site. Therefore, once reduced the concentration below the CSR for inhalation risk inside the facility, the ultimate clean-up goal for groundwater is to reduce and control the off-site migration at the Southern and Eastern borders of the site. In particular, a general conformity of the Southern border of the site is registered, with an exception at one piezometer at the south-eastern site boundary, where concentrations for TCE are slightly over the potable limit (10 µg/L) and one order of magnitude above the regulatory limit (CSC = 1.5 µg/L). Along the Eastern border, one piezometer exceeds regulatory limits both for 1,2-DCA and 1,2DCP, with a contamination 2-3 orders of magnitude above the respective regulatory limits (CSC for 1,2-DCA = 3 µg/L; CSC for 1,2-DCP = 0.15 µg/L).



3. Pilot-scale application in field

No pilot test was performed

4. Full-scale application

4.1 Extraction system

The SVE system is composed of two extraction wells and an horizontal trench, and it is combined with an Air Sparging (AS) system which includes four wells. The characteristics of the installed systems are as follows:

- N.2 SVE wells (namely SVE1 and EMW30 both 7 meters deep, with a screened interval from 3 to 7 m bgl. SVE1 is 4" diameter, and EMW30 3");
- N.1 horizontal trench (100 meters long, with a diameter of 200 mm);
- N. 4 AS wells (one close to the trench and EMW30, namely AS1p, and three close to SVE1, namely AS14, AS15, AS16). AS wells are 15 meters deep, and with a 2" diameter. They are all screened in the interval 14-15 m bgl;
- the SVE system is powered by a blower "MAPRO 36/21" (5.5 kW, 220V, triphase 50 Hz);
- the AS system is powered by a scroll compressor "Atlas Copco SF2" (2.2 kW, 220V, triphase, 50 Hz).

4.2 Injection system

As previously mentioned, four injection wells are installed to circulate air in groundwater (Air Sparging) with the scope to strip contaminants that would then be collected by the SVE system. Air is injected at an average pressure of 1 bar.

4.3 Radius of influence

The theoretical value of ROI, calculated in the design phase for the Air Sparging was estimated as 5 to 10 meters.



4.4 Off gas Treatment

As for off-gas treatment, there are two granular activated carbon (GAC) filters (1 cubic meter each) in series connection.

4.5 Control parameters

- Air flow and extraction rates
- Air pressure measurements
- Water levels
- Dissolved oxygen and contaminant concentrations in groundwater
- Oxygen, carbon dioxide and contaminant concentrations in SVE off-gas or soil vapour
- Mass removal

7. Additional information

7.1 Lesson learnt

- Low permeability soils difficult to treat through AS technology.
- The presence of heterogeneous subsoil is a big challenge for this types of in-situ technologies.



7.2 Additional information

To assess the success of remediation is fundamental to perform:

- trend analysis of each contaminant monitored over time with respect to the initial baseline value
- quantification of extracted mass over time

7.3 Training need

To ensure the achievement of remediation goals is fundamental to perform a good operation and maintenance of the overall system. To do that is important that the system is managed by trained personnel. Despite a general training can be done from webinars and e-learning to obtain a targeted training specific for the single system installed few on-the job session, especially in the first weeks of system running, can be a good way to have site personnel sufficiently trained with respect to the specific performances of the system installed.

Glossary of Terms

A glossary will help a you to maintain the level of precision necessary for key terms and maintain consistency across the text. We found out that sometimes terms that sounds similar like “contaminated” and “polluted” are used in the same way as synonyms in some country, while in other they have different meanings (due to legislation or for other reasons). So fill in this glossary for your key elements and of course for acronyms.

Term (alphabetical order)	Definition
SSTLs or CSR	Site Specific Target Level, which are named CSR in Italian regulation, are concentration target levels defined according to Risk Analysis procedure

1. Contact details - CASE STUDY: SVE n.4

1.1 Name and Surname	Luca Sacilotto
1.2 Country/Jurisdiction	Italy
1.3 Organisation	Ramboll Italy S.r.l.
1.4 Position	Senior Managing Consultant
1.5 Duties	Project management of contaminated sites and brownfield assessments for industries; development and implementation of complex remedial projects addressing a wide variety of contaminants in several hydrogeological settings.
1.6 Email address	lsacilotto@ramboll.com
1.7 Phone number	+39-3341319233

2. Site background

2.1 History of the site

Since its first installation (1970), within the site have been produced compressors for refrigerators and air conditioning units. The analysis of the production processes within the facility highlighted the use in the past of potentially polluting substances such as heavy metals and chlorinated solvents, mainly PCE, TCE and Cr IV. The production was active up to 2018 and then the assembly lines have been dismantled.

2.2 Geological setting

Site soil consists largely of silts and clays interbedded with thicker layers of fine sands. This succession mainly consists of silty-clayey layers with two major sandy layers of different thickness, ranging from few centimetres to about 1 meter, located in the following ranges of depth:

- Level 1: between 10 and 15m b.g.s.
- Level 2: between 25 and 30m b.g.s.

The depth to ground water is approximately 5-7 meters below ground surface.

The following image depict the geological setting of the first two meters of soil subjected to ventilation through the SVE system.





2.3 Contaminants of concern

The main compounds of concern are:

- tetrachlorethylene (PCE),
- trichloroethylene (TCE),
- cis 1,2-dichloroethylene (cis 1,2-DCE),
- trans 1,2-dichloroethylene (trans 1,2-DCE),
- 1,1-dichloroethylene,
- chloroform,
- vinyl chloride (VC),
- freon-11,
- freon-113

2.4 Regulatory framework

The administrative path of the remediation process started on 2001 when the client informed the Public Authorities of a potential contamination resulting from the presence of chlorinated solvents in groundwater detected during a series of investigations carried out in order to verify the quality of the subsoil at the Site. Subsequently, the following activities have been done: Site Characterization, Preliminary Remediation Design, Final Remediation Design for the treatment of the contamination from groundwater. In 2016 an ambient-air survey highlighted the absence of risks for workers to be exposed to contaminant chlorinated vapours stemming from the contaminated groundwater.

Nevertheless, the client, as a preventive and precautionary measure for workers decided to install a Soil Venting system (same technology of a classical SVE system) to brake any possible migration pathway of contaminated vapours from the groundwater to the productive building.



3. Pilot-scale application in field

3.1 Extraction system

Before the installation of the full scale system, a pilot scale application has been performed to estimate the effective radius of influence that potentially can be achieved from each extraction well. The test was carried out connecting, through flexible pipes, one vertical well of 4" diameter, 2 m depth screened from 0.5 m below ground level to 2 m depth, with a blower for vapour extraction (with filters and silencers). In addition, the system included a condensate separator to remove water from the extracted gas before to pass through the blower and a granular activated carbon unit (200 L) to treat the contaminated vapour streams before the emission in atmosphere. Moreover, the well head of the extraction well was equipped with a pressure gauge and connected to the extraction system through a flexible pipe. Along the extraction line (2" diameter) there was a manual adjustment valve, vacuum gauge, sampling points and two asameters for air flow measurement.



3.3 Radius of influence



Examples of vacuum measurements at wellhead (left) and monitoring point (right)

Two tests were performed to estimate the radius of influence: step test and long duration test.

For the step test increasing flow rates have been considered with values centred around the design value:

- 26 m³/h
- 40 m³/h (design value)
- 50 m³/h
- 80 m³/h
- 125 m³/h

During each step test, the following parameters were monitored:

- suction depression at the blower,
- depression on the wellhead of the suction point,
- depression induced on the soil gas monitoring points,
- flow rate of extracted gases,
- VOC concentrations.

On the basis of the step test outcomes a flow rate of 60 m³/h has been sustained



constant for about 48 hours during which the same parameters of the step tests have been monitored.

Plotting in semi-logarithmic graph the depressions induced in the monitoring points at different distances from the extraction well and considering a cut-off pressure of 1% of the depression measured at the wellhead (Johnson and Ettinger, 1994), namely 0.12 mbar, a ROI of about 120 m has been estimated from the suction shaft considered for pilot test.

3.4 Off gas Treatment

During the pilot scale application in field, off gas were treated by a granular activated carbon unit of 200 L to treat the contaminated vapour streams before the emission in the atmosphere.

3.5 Control parameters

To assess the effectiveness of the treatment the following parameters were monitored during the pilot scale application:

- suction depression at the blower,
- depression on the wellhead of the suction point,
- depression induced on the soil gas monitoring points at different distances from the extraction well,
- flow rate of extracted gases,
- VOC concentrations.

4. Full-scale application

4.1 Extraction system

The full scale SVE system basically consist of 5 extraction wells, 4 of which within the productive building and 1 in the external area still within the site boundary. Each vertical extraction well is of 4" diameter, 2 m depth screened from 0.5 m below ground level to 2 m depth. Each vacuum well is connected to the vacuum unit through HDPE underground and aboveground pipes of 2", 3" and 4" to take into account pressure drop along the line.

The vacuum unit is basically composed of 2 vacuum blowers (one as backup blower), air flow rate 230 Nm³/h each, with filters and silencers, 1 condensate separator to remove water from the extracted gas before to pass through the blower and 1 electrical panel to control the blowers. Outside the vacuum unit there are 2 granular activated carbon units (1 m³ each with about 600 kg of carbons) and a chimney for treated gas emissions. Each well head is equipped with a pressure gauge and along each of the 5 extraction lines there are from the bottom to the top: sampling port, flow meter, pressure gauge, regulation valve, on/off valve.



Examples of instruments along each extraction line

The system is completed by 32 monitoring points spatially distributed to cover the overall treated area.

To assess the different performances for different monitoring system we installed:

- N. 9 “nesty probes”, 7 of which in external area and 2 within the facility;
- N. 23 “vapor pin” within the facility.



Nesty probe



Vapor Pin

4.3 Radius of influence

As a result of pilot test an extraction flow rate of about $50 \text{ m}^3/\text{hour}$ for each of the 5 extraction wells has been set and a ROI of about 50 m has been associated with each extraction well in order to cover the planar extension of the groundwater plume which has basically an orientation north-south. The following image depict the expected ROI (brown dotted lines) from each extraction well (green squares).

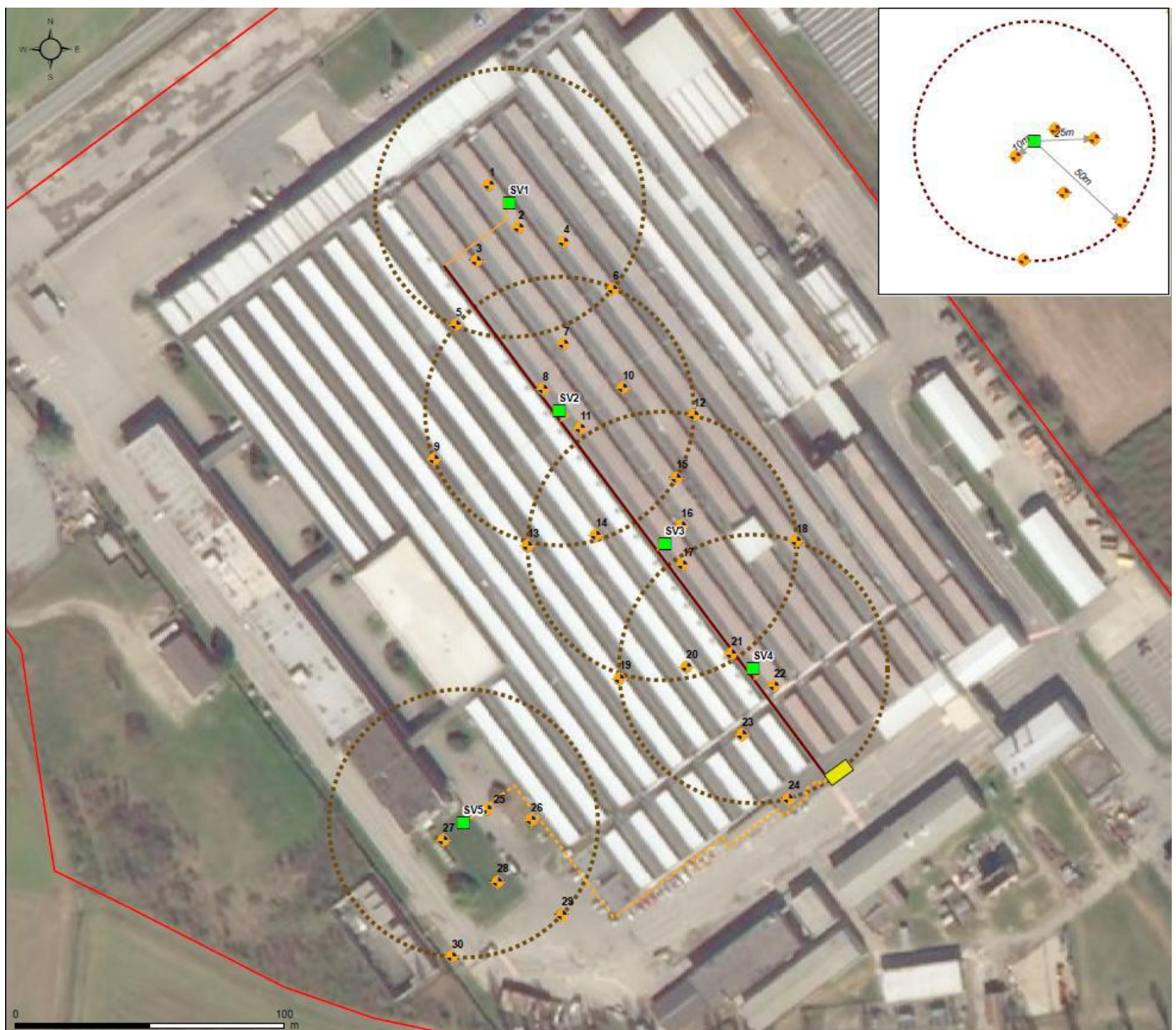

System layout with expected ROI

4.4 Off gas Treatment

Off gas treatment is basically composed of 2 granular activated carbon units (1 m³ each with about 600 kg of granulated activated carbons) and a chimney for treated gas emissions in the atmosphere.





4.5 Control parameters

To assess the effectiveness of the treatment the following parameters were monitored with the following frequency

With a weekly basis:

- flow rate of each extraction well,
- temperature and pressure/ suction depression both upstream and downstream the blower,
- the occurrence of condensate waters,

With a 3 months basis:

- VOC, O₂, CH₄, CO₂ and depression induced at each monitoring point,
- soil gas concentration for each monitoring point, well heads and off gases before the emission in atmosphere

5. Enhancements to SVE

No pneumatic and/or hydraulic fracturing systems has been employed to enhance the SVE application which was designed only to ventilate and hence brake any possible pathways of contaminated streams from the groundwater to the productive building.

6. Post treatment and/or Long Term Monitoring

6.1 Post treatment and/or Long Term Monitoring

The treatment is still ongoing but as a long term monitoring plan it can be scheduled monitoring campaigns on a six months basis on each soil gas control point available at the site and an ambient-air monitoring survey on a year basis to verify if any changes with respect to the status achieved at the end of ventilation.



7. Additional information

7.1 Lesson learnt

1) Methodology and procedures

Before the installation of a full scale system perform a pilot test to verify, with field data, the design hypothesis related to ROI extension and flow rate achievable from each extraction well since due to local heterogeneities not all wells perform at the same way.

2) Technical aspects

Prior the installation of the extraction wells perform a detailed screening and review of historical maps of the areas that need to be treated with a sub slab ventilation to assess the occurrence of any subsurface services which can reduce the extension of expected ROI, hence reducing the overall efficacy of the system.

3) Legislative, organizational aspects

To be compliant with regulation limits for off gas emission is key the periodic check of the efficacy of the treatment system to avoid the emission in atmosphere of contaminated gases.

7.2 Additional information

To assess the success of remediation is fundamental to perform:

- trend analysis of each contaminant monitored over time with respect to the initial baseline value
- quantification of extracted mass over time

7.3 Training need

To ensure the achievement of remediation goals is fundamental to perform a good operation and maintenance of the overall system. To do that is important that the system is managed by trained personnel. Despite a general training can be done from webinars and e-learning to obtain a targeted training specific for the single system installed few on-the job session, especially in the first weeks of system running, can be a good way to have site personnel sufficiently trained with respect to the specific performances of the system installed.

1. Contact details - CASE STUDY: SVE n.5

1.1 Name and Surname	Federico Caldera
1.2 Country/Jurisdiction	Italy
1.3 Organisation	Mares S.r.l.
1.4 Position	Analista Sviluppo & Compliance
1.5 Duties	Sanitary and environmental risk assessment, innovative remediation and characterization technologies development
1.6 Email address	federicocaldera@maresitalia.it
1.7 Phone number	+39 3497616386

2. Site background

2.1 History of the site

The site is a gas station in peripheral area south of a city of central Italy, along a road with medium vehicular traffic.





2.2 Geological setting

The geological structure of the area is characterized by the presence of soils of volcanic origin and deposits of alluvial origin.

In the area under examination the volcanic deposits of the Pleistocene age produced by the volcanic systems of Lazio emerge.

From a geomorphologic point of view, the site is located on the slope in a hilly area artificially terraced for the construction of the square.

Hydrography essentially consists of a series of ditches which, with dendritic branching, flow north-east. They have a torrential regime, with superficial outflows that occur during intense rainfall and of a certain duration, mainly in the winter season.

The area is characterized in general by soils with variable permeability, both in relation to the variety of soils constituting the stratigraphic succession, and to the frequent variability of the lithological and structural aspects found within the individual units that make up this succession.

The site stratigraphy is characterized by the presence of the following two main units:

- Anthropogenic material - Mixed material, essentially consisting of medium sand with the presence of gravel/pebbles, which extends from 0 m from ground level. about 3 m b.g.s.;
- Silt and Clays - Cohesive deposit made up of silts and clays with local intercalations of coarser sandy lenses, found up to the maximum investigated depth (10 m b.g.s.).

Literature data allow us to hypothesize the presence of a significant underground water circulation at high depths: in a well surveyed about 400 m south of the gas station area, a water table level of 78 m a.s.l. is reported, corresponding to a depth from the ground surface at the site of about 45-50 m.

2.3 Contaminants of concern

Contamination affected unsaturated soil, with BTEX, C_{≤12} and C_{>12} as CoCs, found at a depth of 3.4 m b.g.s.



2.4 Regulatory framework

In Italy the environmental regulatory system is regulated by Legislative Decree No. 152/2006 and for fuel stations by the Ministerial Decree No. 31/2015.

The target values for benzene, toluene, ethylbenzene, xylene, C<12 and C>12 are set equal to 50, 50, 50, 50, 250 and 750 mg/kg, respectively, for soils with commercial use. For the implementation of SVE technology (as well as for the implementation of any remediation plan) the approval by local authorities is needed.

3. Pilot-scale application in field

3.1 Extraction system

The execution of the pilot test, placing vertical wells SN03 and SN04 (5 meters depth, screened between 1 and 5 m b.g.s.) in depression by a blower, showed that:

- by varying the extraction rate (from 30 to 1000 L/min) within point SN03, rather small depressions were detected in the monitoring points, in any case lower than the value of 0.5 mbar (the maximum value was 0.3 mbar observed in SN04 with an extraction rate of 1000 L/min) indicated by literature as the minimum depression to have an induced influence from the well being extracted (“cut off” value);
- during the test a further test was performed by putting in depression point SN02: also in this case, depressions were observed within the point SN03 lower than the value of 0.5 mbar (the maximum value was 0.2 mbar observed in SN03 with an extraction rate of 2330 L/min);
- no condensation accumulation was detected during the test inside the separator.

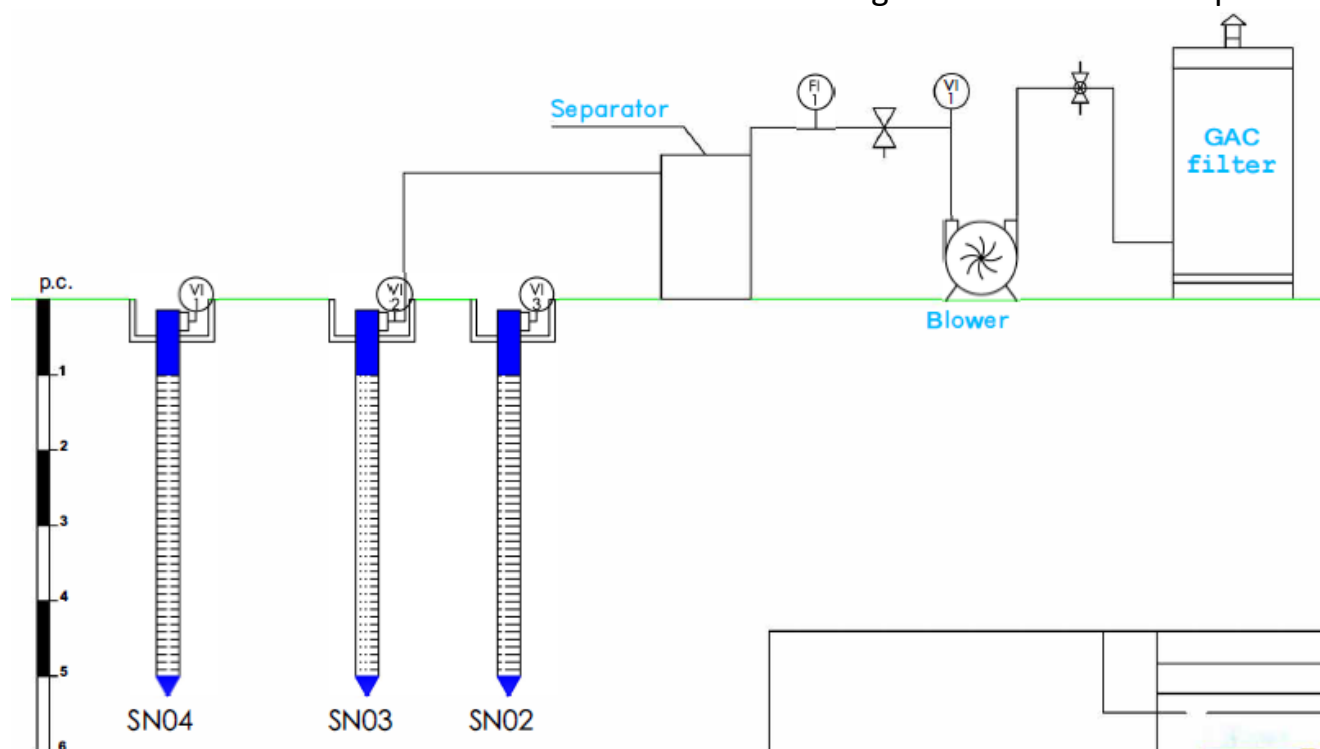

The results obtained by means of the pilot study performed allowed to confirm the applicability of the SVE system to the site. The high permeability of the subsoil to vapor flows, in fact, made it possible to extract significant quantities of air without inducing significant depressions.



3.3 Radius of influence

The project parameters, obtained on the basis of the pilot study specifically performed on the site, are the following:

- Radius of influence, ROI: 3.0 m;
- Maximum flow rate of extracted air for each SVE point, Q_{Ea}: 70 m³/h;
- Working depression at each point, d_{Pp}: - 50 mbar.

3.4 Off gas Treatment

For the abatement of pollutants present in the extracted air was set, downstream of the air/liquid separation system, a pair of iron with epoxy treatment filters, filled with activated carbon in pellets, (H 1400 mm x D 780 mm).

3.5 Control parameters

During the test, the data listed below were recorded:

- extraction rate;
- d_{Pp} work-related depression and d_{Pi}-induced depression;
- VOC, CH₄, CO₂ and O₂ in the extraction well.

4. Full-scale application

4.1 Extraction system

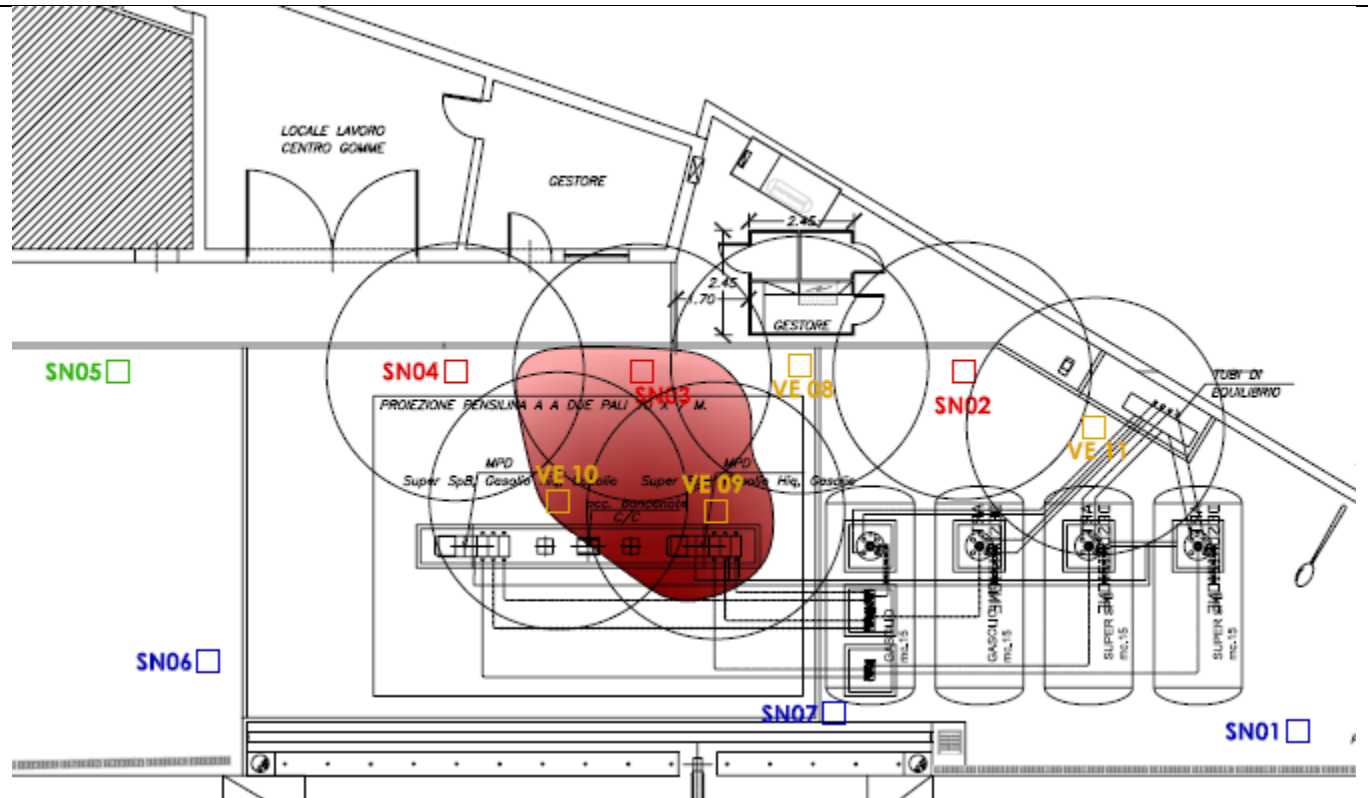

A blower is used to extract air from the remediation points; the extracted air favours the removal of contaminants from the solid phase to the gas phase. The air extracted from the same points is conveyed inside a condensate separator (S1) which separates the condensate from the gaseous flow.

The gaseous flow, once dehumidified and the particulate removed, passes through the blower which generates the vacuum. Downstream there is the air handling unit consisting of two filters in series, containing activated carbon. In any case, the processing unit is equipped to be arranged with the filters in parallel in case the incoming flow shows compatible VOC concentrations.

In order to maximize the treatment of the unsaturated soil and to reduce the moisture content of the extracted air, the plant is also provided with an evacuation, treatment and discharge system for the percolating waters that accumulate preferentially in the SN02 and SN03 piezometers.

Two additional extraction points located outside the contaminated area were installed, with the aim of enhancing the recall of vapours from the subsoil to further safeguard the human targets located in the building next to the gas station.

The number of SVE points is therefore equal to 7. Specifically, the existing piezometers SN02, SN03 and SN04 and the new points VE08, VE09, VE10 and VE11 were used, see the picture below.

The suction from the points was operated by a pump capable of reach a vacuum of at least 150 mbar, and a flow rate of not less than 500 m³/h, in order to guarantee an air flow, for each extraction point, of at least 70 m³/h, with a nominal power of about 5.50 kW.

4.3 Radius of influence

Considering the ROI determined through the pilot test and the areal distribution of the contamination, the number of extraction wells and their spatial location were defined. A correct ROI value of 3 m was therefore adopted as a precaution.

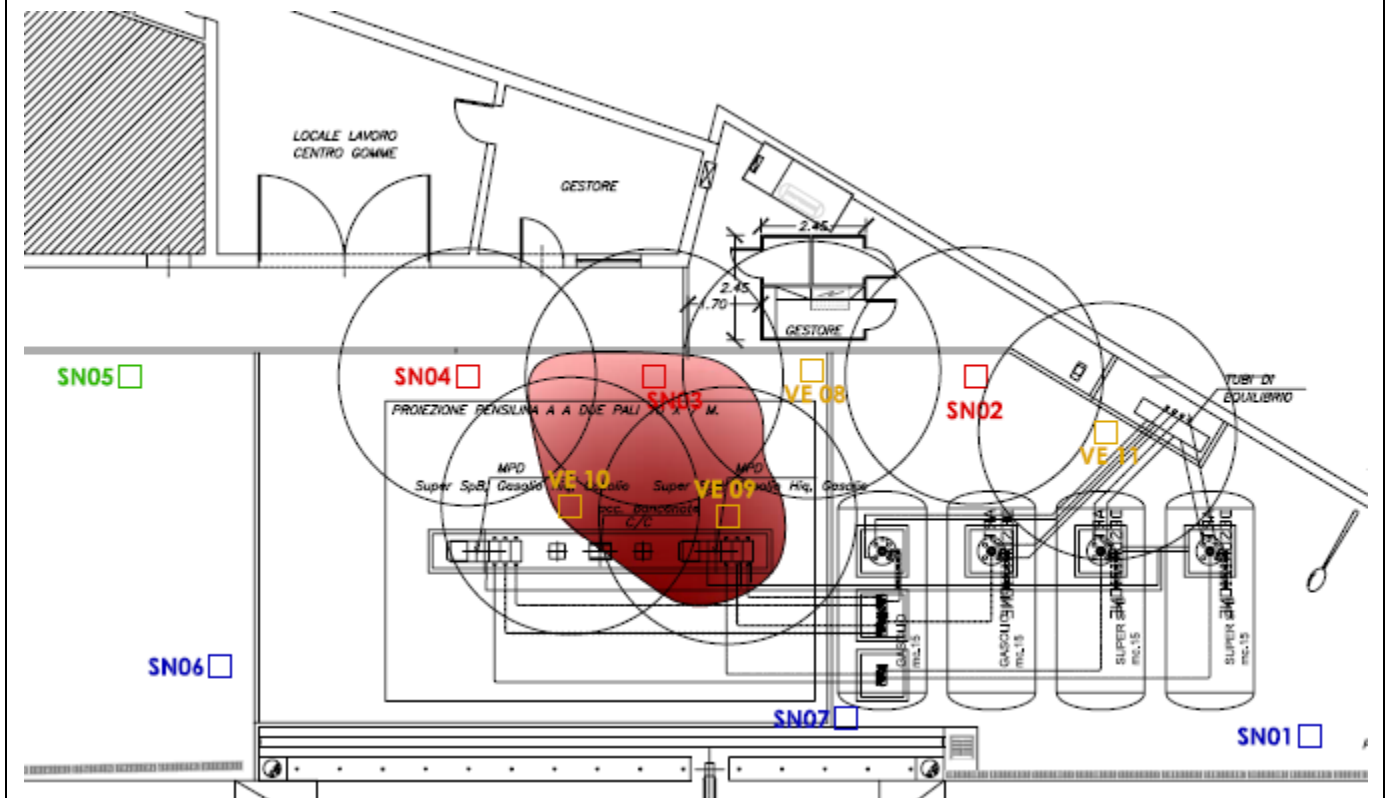

4.4 Off gas Treatment

Same of pilot test



4.5 Control parameters

Before starting the system, at Time Zero, a complete monitoring was carried out. In particular, the following activities were carried out on all the extraction wells present on site (VE02, VE03, VE04, VE08, VE09, VE10 and VE11):

- measurement of the VOCs present in the extraction points;
- sampling of off air and analysis of parameters such as BTEX and TPH.

During the start up of the system, the following measurements were carried out on a weekly basis:

- measurement of the VOCs extracted from the points and leaving the stack (ppm);
- vacuum induced by the blower (mbar) in the extraction points;
- flows at each extraction point;
- depression induced on the water inside the extraction points.

The start up took about 30 working days and ended with the testing of the air and water treatment system by sampling and laboratory analysis of the vapours entering and leaving the system.

Then, on a monthly basis, control visits were carried out on the plant in order to verify the correct functioning of the system and monitor the operating parameters of the plant (measurement of VOCs, induced depressions, extracted air flows, extracted water flows) making any new adjustments if necessary.

6. Post treatment and/or Long Term Monitoring

6.1 Post treatment and/or Long Term Monitoring

The periodic monitoring of the SVE system (between 2018 and 2020) provided for:

- control, maintenance and monthly monitoring of the systems and verification of the correct functioning of the system;
- verification and reading of the operating parameters of the system (flows, temperatures, pressures, etc.);
- possible fine-tuning, in the case of variations detected with respect to the operating parameters;
- sampling of air inlet and outlet from the treatment system and analysis of the BTEX and TPH parameters.



7. Additional information

7.1 Lesson learnt

In presence of a VOC contamination located in a small part of unsaturated soil with a coarse texture the SVE technology can be a viable system to reach the remediation goals.

The intervention was successful - Authorities certification obtained after two years of remediation.

7.2 Additional information

The keystone issue for a successful remediation is to gain a right conceptual site model, with a proper definition, in terms of extent, soil texture and presence of preferential flow pathways of the underground contamination source, in order to find adequate technology to properly address and remediate the CoCs.

7.3 Training need

Firstly e-learning/webinars in order to understand the theoretical fundamentals of the technology, following training on the job so to gain experience with facing real problems.

Glossary of Terms

Term (alphabetical order)	Definition
BTEX	Benzene, Toluene, Ethylbenzene, Xylene
C \leq 12	Light hydrocarbons
C $>$ 12	Heavy hydrocarbons
VOC	Volatile organic compounds (VOCs) are organic chemicals that have a high vapour pressure at ordinary room temperature

1. Contact details - CASE STUDY: SVE n.6

1.1 Name and Surname	Davide Menozzi, René Filion, Sophia Dore
1.2 Country/Jurisdiction	United States of America
1.3 Organisation	GHD Group Pty Ltd
1.4 Position	Environmental scientist (Davide Menozzi) Senior Project Manager (René Filion) Senior Scientist Innovative Technology Group (Sophia Dore)
1.5 Duties	Contaminated land management
1.6 Email address	Davide.menozzi@ghd.com
1.7 Phone number	+61 2 4222 2316 (Davide Menozzi) 01 514 339 0611(René Filion); 716 205 1978 (Sophia Dore)

2. Site background

2.1 History of the site

Approximately 23,000 kg of acetone was released from a rail car during unloading in July 2016 at a facility that stores, repackages, and distributes chemical products to wholesalers and industrial users.

The Property is irregular in shape, covers an approximate area of 125,000 square meters (m²) and is located in a industrial area, with a neighbouring residential area located to the south. This residential neighbourhood is located within 35 meters (m) from the Property limit at its closest proximity. A series of railway sidings are present at and in the western portion of the Site.





2.2 Geological setting

The Site stratigraphy in the area of the spill consisted of very shallow fill material extending to 0.6 m below ground surface (mBGS), followed by a layer of natural deposits silt with traces of clay or clay with traces of silt to approximately to approximately 4.5 mBGS. A layer of coarse material composed of sand and gravel measuring approximately 0.3 m thick rests on a grey fractured limestone with fair to excellent rock quality (RQD >95).

Native soils were composed of an initial deposit of silty clay, becoming at around 3 m below ground surface, a deposit composed of more sandy material, either being described as silt with some sand and traces of gravel, or as sand with some silt and gravel.

During intrusive investigations, odours were strongest near the surface (0.6 m to 1.2 m deep) and again near the bottom (4.3 m to 4.9 m deep).

2.3 Contaminants of concern

Acetone (primary)

Secondary contaminants:

Ethylbenzene

Toluene

Xylene

2.4 Regulatory framework

Following implementation of a Pilot Scale test at the Site that demonstrated effective operating conditions for SVE, a remedial objective of 28 mg/kg was established for acetone in soil, based on similar land use regulatory standards. For the secondary contaminants, existing standards for industrial/commercial land use were selected as remedial objectives (Ethylbenzene = 50 mg/kg, Toluene = 30 mg/kg, Xylene=50 mg/kg).



3. Pilot-scale application in field

3.1 Extraction system

One shallow vertical extraction well screened to impart vacuum within the impermeable (shallow) layer of soil were installed throughout the treatment area. The effective radius of influence for these wells was approximately 3 metres. The shallow wells were equipped with 4-inch diameter PVC screens and risers, and terminated near the surface. Two existing 2-inch diameter vertical wells were used to extract vapours from the more permeable and deeper sand and gravel layer as the screened intervals for these wells intercepted the more permeable layer and extended to the top of bedrock/soil interface. The effective radius of influence measured during pilot testing for these wells was approximately 20 m.

A self contained mobile SVE equipment trailer was mobilized to the treatment area. The equipment included a high vacuum, high flow vacuum blower capable of producing up to 100 cubic feet per minute, and a vacuum of 10 inches of mercury, distribution header moisture separator, piping, valves and gauges, barometer, and vacuum gauges. The system was equipped with remote monitoring to the system control panel which could be programmed to run several configurations and on with definable operating timeframes.

3.2 Injection system

No injection of air or other substances were permitted.



3.3 Radius of influence

Radius of Influence

The radius of influence (ROI) for each pilot test is estimated based on the vacuum response measured at the SVE monitoring probes and nearby wells, as well as past experience gained from operating SVE systems in similar soils. A probe response of 0.5 to 1.0 percent of the applied SVE wellhead vacuum is generally considered significant in ROI estimation. Due to the soil heterogeneity at the site and surface conditions, a wide range of vacuum response was observed. While vacuum response was achieved in the distant monitoring wells, response at the probes installed in the tighter material was inconsistent and likely masked by fluctuations in ambient barometric pressure.

Upper Zone

As expected, the soil heterogeneity limited flow and vacuum response in certain directions due to pockets of tight native clays and silts that exist in the subsurface. In the upper zone, the monitoring probes showed a better response to the north compared to the south of SVE-01. The northern portion of the Site showed that an ROI of 3-4 meters would be achievable. The southern portion of the Site showed an ROI of less than 2 meters. ROI estimates showed very similar results when operated between 4 and 10" Hg vacuum. In this zone, the readings indicated that applying a less powerful vacuum may be more beneficial to achieving the best ROI as the 4" Hg vacuum showed the highest induced vacuum readings. The data also suggests that a period of hot, dry weather may have caused desiccation of shallow soils and well seals and resulted in short circuiting of ambient air from the surface. Hydration of surface soils in the pilot test area was successful in reducing the short-circuiting effects.

Lower Zone

The lower, more permeable zone showed a more significant ROI compared to the Upper Zone. Based on the readings taken, operating at 6" Hg vacuum would provide the greater ROI with distances exceeding 20 meters. Of note, operating at higher vacuums dropped the ROI significantly, to a distance of only 6-8 meters. The extended ROI observed in the lower zone test is likely due to the higher permeability lenses and gravel observed at the top of bedrock in soil borings within the impacted area.

Air Flow Rate versus Vacuum

Initially, for each step test, the unit was operated for short durations at various flow



rates and corresponding vacuum levels for the purpose of determining the SVE performance over the operating range of the blower and selecting the appropriate flow rate for the test (based on SVE flow rate and wellhead vacuum levels). Flow rate versus vacuum curves were constructed from these step test data to assist in the selection of the most desirable operating range for a full-scale system. An example of the results is shown in the figure below.

Upper Zone

The step test showed a desirable operating range between 25-40 CFM with an applied vacuum of 4-6" Hg.

Lower Zone

The step test at PO-101 (see Figure below) displayed good performance without a drop off up to a flow of 40 CFM with an applied vacuum of 8" Hg

AIR FLOW RATE VERSUS VACUUM

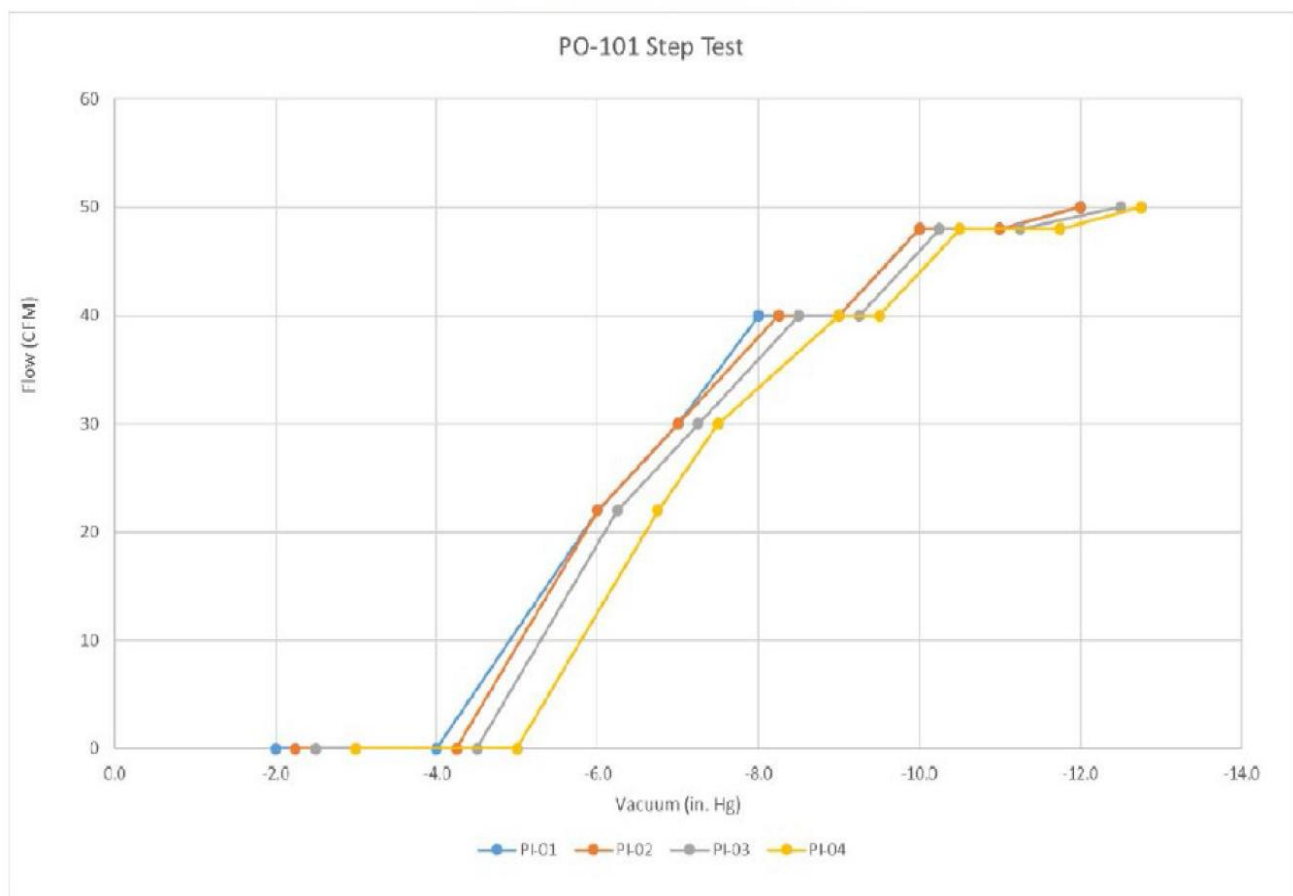



3.4 Off gas Treatment

Extracted vapour treatment was completed using a 205 L drum of activated carbon during the short duration pilot testing period. No samples were collected of the air emissions during the pilot test.

3.5 Control parameters

Soil analytical results were collected prior to and following each treatment phase to evaluate compliance with remedial objectives. These results were also used to configure the following phase of treatment (progressive reduction of treatment area). Groundwater samples were collected and submitted for analysis of volatile organic compounds (VOCs) within and downgradient of the treatment area to monitor for potential releases to groundwater from treatment activities.



4. Full-scale application

4.1 Extraction system

A total of 8 shallow vertical extraction wells screened to impart vacuum within the impermeable (shallow) layer of soil were installed throughout the treatment area. The effective radius of influence for these wells was approximately 3 m. The shallow wells were equipped with 4-inch diameter PVC screens and risers and terminated near the surface.

Five 2-inch diameter wells were used to extract vapours from the more permeable and deeper sand and gravel layer as the screened intervals for these wells intercepted the more permeable layer and extended to the top of bedrock/soil interface. The effective radius of influence measured during pilot testing for these wells was approximately 20 m.

A self contained mobile SVE equipment trailer was mobilized to the treatment area. The equipment included a high vacuum, high flow vacuum blower capable of producing up to 100 cubic feet per minute, and a vacuum of 10 inches of mercury, distribution header moisture separator, piping, valves and gauges, barometer, and vacuum gauges. The system was equipped with remote monitoring to the system control panel which could be programmed to run several configurations and on with definable operating timeframes.

4.3 Radius of influence

Based on the collected field data, the radius of influence of the deeper extraction wells measured was between 9.7 and 18 m, while the radius of influence of the SVE wells was between 5.1 m and 9.9 m.



4.4 Off gas Treatment

Discharge vapour monitoring of the system was performed in between and after the two 1,800-pound vapour phase carbon treatment vessels weekly by GHD using a photo ionization detector (PID) for measurement of undifferentiated VOCs.

Air Sampling

In addition to the field PID readings collected above, air samples were collected at the sample port located between the two vapour phase carbon treatment vessels to monitor their performance to ensure that air emissions were below the regulatory limits.

Additional air samples were collected over the course of the SVE treatment in the extracted vapour flow before being treated to evaluate the extracted acetone mass through the vapour stream.

Compliance

PID measurements in between and after the two vapour phase carbon treatment vessels showed readings of 0 ppm throughout the active SVE treatment period.

A dispersion model using SCREEN3 software was completed to assess compliance of air emissions equivalent to 2.5% of the regulatory limit for a 4-min exposure and 1.3% of the regulatory limit for a 1-hour exposure. Analytical results of samples collected throughout the treatment period identified concentrations of acetone reached approximately 1.1% of the permissible exposure rates.

Based on the PID measurements and analytical results from the air samples, air emissions did not present any exceedance of the applicable regulation during the operations of the SVE system.



4.5 Control parameters

Soil analytical results were collected prior to and following each treatment phase to evaluate compliance with remedial objectives. These results were also used to configure the following phase of treatment (progressive reduction of treatment area).

Groundwater samples were collected and submitted for analysis of VOCs within and downgradient of the treatment area to monitor for potential releases to groundwater from treatment activities.

6. Post treatment and/or Long Term Monitoring

6.1 Post treatment and/or Long Term Monitoring

Post treatment groundwater monitoring will be completed three times per year for a minimum of 3 years to evaluate potential impacts to groundwater.

7. Additional information

7.1 Lesson learnt

SVE was an effective method for remediation of highly volatile contaminants at this Site. The addition of an impermeable ground cover layer effectively controlled short circuiting in the area of highest concentrations immediately adjacent to the spill area.

7.2 Additional information

Success of remediation will be assessed in the post-remediation monitoring program.



7.3 Training need

Designing a remediation system requires experience. This cannot be easily built up through workshops, webinars and so on. Designing and implementation of a successful remedial system should be undertaken by an experienced company and scientists.

Glossary of Terms

A glossary will help a you to maintain the level of precision necessary for key terms and maintain consistency across the text. We found out that sometimes terms that sounds similar like “contaminated” and “polluted” are used in the same way as synonyms in some country, while in other they have different meanings (due to legislation or for other reasons). So fill in this glossary for your key elements and of course for acronyms.

Term (alphabetical order)	Definition
VOC	Volatile organic compounds (VOCs) are organic chemicals that have a high vapour pressure at ordinary room temperature
CFM	Cubic feet per minute

1. Contact details - CASE STUDY: SVE n.7

1.1 Name and Surname	Hadas Sharon
1.2 Country/Jurisdiction	Israel
1.3 Organisation	Ludan environmental technologies
1.4 Position	Environmental engineer
1.5 Duties	Project manager
1.6 Email address	hsharon@ludan.co.il
1.7 Phone number	+972 52-511-2139



2. Site background

2.1 History of the site

A gas station operated at the site located in Israel for many years.

As part of the change in the designation of the land, from a gas station for a commercial activity area, soil sampling was carried out in the area where underground fuel tanks were located, in order to make sure that the soil was not contaminated.

2.2 Geological setting

The following is a description of the geological section in the area:

0-10 meters - loess and limestone.

10-300 meters - cardboard, gray mahogany cardboard.

2.3 Contaminants of concern

The following are the various contaminants that are suspected in the soil due to the type of activity carried out at the site. These are pollutants that originate from fuel components:

- TPH
- BTEX
- MTBE
- PAH



2.4 Regulatory framework

- The subject of soil contamination investigation is the responsibility of a government ministry - the Ministry of Environmental Protection - Department of contaminated soils.
- The soil investigation performed according to the professional guidelines of the Ministry of Environmental Protection, which approves the sampling plan before execution and the conclusions and recommendations given according to the sampling findings.
- The concentrations of the pollutants discovered were compared to the permitted concentrations according to the threshold values document for industrial areas in the State of Israel.

3. Pilot-scale application in field

3.1 Extraction system

- The system in the ground includes 17 Vertical wells
- The pumping was done using a vacuum truck.

3.2 Injection system

- Details of the SVE pilot system infrastructure:
- The system in the ground includes 17 wells with a diameter of 3 inches, to three different depths: 7, 11 and 16 m below the ground.
- The large number of wells and the varying depths allows to "capture" of all the contaminated soil area.
- Each well is constructed so that at its bottom is a fluted section (strainer) 5 m long.
- The pumping was done using a vacuum truck, which was connected to well manifold, so that at each stage the effect of using a single well or several wells simultaneously could be examined by using the SVE system regulating taps.
- The system also included a clean air inlet tap to prevent the creation of underpressure in the pumping wells.



3.3 Radius of influence

- The radius of impact was determined by performing pumping until the pressure stabilized, measuring the underpressure in the well being pumped with varying flow rates and measuring the underpressure in the other wells to examine the radius of impact.
- The soil at the site was found to have effective conductivity in the tested flows and the underpressure created allowed the suction of the gases above the ground. At a flow of 150 cubic meters/h, a negative pressure of 74 millibars was measured and the impact radius reached up to 10 meters from the suction well.
- Since the average distance between the wells ranged from 4 to 6 m, there was compatibility between the remediation method, the site characteristics and the existing pilot remediation infrastructure.
- According to the pilot findings, it appears that when operating the pump from all the wells, the entire contaminated soil cell intended for treatment will be underpressure and therefore no additional wells need to be installed.

3.4 Off gas Treatment

In order to select the appropriate treatment technology for the airflow from the SVE system, a number of technologies defined as "BAT" (best available technology) (by the EPA) were examined:

1. adsorption on activated carbon
2. thermal oxidation
3. biological filter
4. vapour condensation

Due to the high daily load of organic hydrocarbons, we recommend gas treatment with a thermal oxidation- **catalytic oxygen** method suitable for the treatment of emission stream at concentrations higher than several hundred PPM. Laboratory tests found no evidence of the presence of chlorinated hydrocarbons which can be a limiting factor when using this technology due to the fear of causing damage to the catalytic converter.



3.5 Control parameters

- To estimate the load of hydrocarbons pumped from the wells when the SVE system is working, performed gas sampling of several wells together and from a number of individual wells in which high PID values were detected. Some of the samples were performed on canisters sent for TO-15 analysis.
- In order to evaluate the effectiveness of the treatment for the gas pumped from the wells treated by the thermal oxidizer, a sampling was performed on the stack of the treatment facility.

4. Full-scale application

The full-scale system is compatible with the system built in the pilot and described in the previous sections

4.5 Control parameters

- Throughout the period the system operates, there was regular monitoring once every two weeks of parameters of the system and the soil and once every few months a performed laboratory analysis of TO-15 to the concentrations in the gas stream pumped from the soil.
- The following is the test that is performed every two weeks:
 1. The VOC concentration measured in the well by the PID.
 2. Checking the flow in the pumped stream.
 3. Measuring the pressure in the well.



6. Post treatment and/or Long Term Monitoring

6.1 Post treatment and/or Long Term Monitoring

In order to test the effectiveness of the treatment after its completion, a "rebound effect" test was performed, which included shutting down the system for about a month and a half and restarting it for two months.

The test revealed that the concentrations did not rise and there was no change in the concentrations in the various wells after reopening, with respect to values measured before closing. These findings indicate that the treatment performed on the soil is effective and the volatiles that were adsorbed to the soil have already been treated.



7. Additional information

7.1 Lesson learnt

From the results of the cost-benefit analysis, it can be seen that due to the low concentrations pumped from the soil during the period when the concentration of contaminants decreased, led to high power consumption to operate the system, significantly, as more energy has to be invested in heating the catalyst.

Increased use of electricity to heat the catalyst in the converter causes that per kilogram of pollutant treated emitted into the air during the power generation process at the IEC power plant about half a kilogram of nitrogen oxides and half a kilogram of sulphur oxides.

As the treatment of the site with the SVE method achieved, and the meaning of continued pumping and gas treatment has low efficiency on the one hand and on the other hand requires a lot of energy, its significant environmental consequences with regard to electricity generation emissions.

7.2 Additional information

The SVE system operated for about 9,000 hours during which it handled about 5,641 liters of hydrocarbons.

As part of the treatment, about 4,000,000 cubic meters of soil gases were extracted from the ground in the treated area of about 2,000 cubic meters.

7.3 Training need

Training through workshops, preferably by the Ministry of Environmental Protection in order for the remediation processes to comply with the regulator's guidelines.

1. Contact details - CASE STUDY: SVE n.8

1.1 Name and Surname	VION Mathieu (Expert at Technical Direction) DEVIC-BASSAGET Boris (Technical Director)
1.2 Country/Jurisdiction	FRANCE
1.3 Organisation	SUEZ RR IWS REMEDIATION FRANCE
1.4 Position	Head Office : 17 rue du Périgord, 69330 Meyzieu (France)
1.5 Duties	Engineer - Expertise department manager
1.6 Email address	mathieu.vion@suez.com ; boris.devic-bassaget@suez.com contact.remediation.europe@suez.com
1.7 Phone number	+33(4)72450222



2. Site background

2.1 History of the site

CHIMICOLOR is the former operator of a 1,500 m² site located in the town of La Garenne Colombes, in the outskirts of Paris, whose activity involved industrial painting on various supports.

The site is located in a mixed residential and tertiary district, bounded by:

- Apartment buildings on the west side;
- Apartment buildings on the south sides and is separated by a road and pedestrian crossing alley to access the entrance to a residential parking lot;
- A street on the north side, then apartment buildings beyond that street.

According to the information collected, the site was mainly occupied by the following activities:

- 1928 - 1971: Exploitation of the site by a company which carried out the repair and the assembly of electric refrigerators;
- 1971 - 1992: Operation of the premises by a company specializing in the chemical and electrochemical treatment of metals;
- 2001 - 2012: the company CHIMICOLOR becomes the operator of the site and carries out printing activities on aluminium plates, chemical colouring of aluminium plates, stainless steel engraving and screen printing. The cessation of activity took place in 2012.

The site deconstruction work was carried out between May and July 2014. The facade of the building in the north-west part has been preserved as well as the old administrative buildings.

In addition, during the month of July 2014, the soils located to the right of the south-eastern part of the site had been the subject of earthworks to a depth of 1.2 m.

The area to be cleaned up was in the south-eastern part of the land, covering an area of approximately 250 m².



2.2 Geological setting

According to the geological map of Paris and the data from the basement database (BSS), the geological context in the sector considered is as follows:

- Old quaternary alluvium;
- Limestone of Saint-Ouen made up of marls and limestone banks over a depth of 10 to 15 m;
- Then the sands of Beauchamp, with a thickness of 6 to 7 m.

The various investigations carried out on the site revealed the following average lithological section:

- From 0 to 1 m: predominantly sandy embankments;
- From 1 to 8 m: a layer of sands becoming marly from a depth of 4 m;
- From 8 m: limestone.

According to information taken from the subsoil database (BSS) and the hydrogeological map of the Paris basin, several water tables are present under the treatment area:

- The Saint-Ouen limestone aquifer, whose piezometric level was established at about 16 m deep;
- The Beauchamp sands aquifer, the piezometric level of which was established at about 24 m deep.

According to the groundwater quality monitoring campaigns carried out in 2012 and 2013, the water levels at the site were recorded between 15.7 and 16.4 m deep in the limestone water table of Saint-Ouen. Due to the location of the site in a bend of the Seine, 2 km north-west and south-east of the site, the flow direction is variable, with a very low hydraulic gradient.



2.3 Contaminants of concern

The investigations carried out on the site before the start of the works made it possible to characterize the impact on the right of the area to be decontaminated.

The results summarized below indicated the presence of a tetrachlorethylene impact (PCE):

- In soils. This impact mainly concerned surface soils down to a depth of 1 m (contents at the level of the S6B hole of the order of 4.3 mg/kg). The maximum level (6.7 mg/kg) was observed between 4 and 5 m deep at the level of a borehole located at the level of the former product storage area. The vertical extension of the pollution in the soils was not delimited beyond 6 m of depth but the detection of PCE in the groundwater seemed to suggest that this impact had locally migrated towards the groundwater;
- In soil gases at the level of the most superficial horizons between 0 and 5 m deep. The various campaigns carried out had made it possible to measure PCE contents of between 7.5 and 1,435 mg/m³;
- In groundwater in the area of structures located in the area but also on a structure outside the site right-of-way. Studies prior to 2014 revealed PCE contents varying between 3,900 and 8,300 µg/l. According to the groundwater quality monitoring campaigns dating back to 2015 at the site, the PCE contents varied between 100 and 4,100 µg/l. Previous studies had also revealed the presence in small quantities of PCE degradation by-products including trichloroethylene (contents between 0.37 and 8.5 µg/l) and dichloroethylene (content of 4.9 µg/l).



2.4 Regulatory framework

The decontamination work was undertaken with the aim of improving the quality of the underground environment (unsaturated zone) before the construction of residential buildings.

As part of this project, the decontamination objectives initially selected, on the basis of data relating to the state of the available environments, were as follows:

- Partly southeast of its site => Excavation of part of the land. According to the predictive analysis of the residual risks carried out in January 2014 by a consulting firm, the only measurement of excavation of the earth at a depth of 3 m was supposed to make it possible to obtain an admissible residual risk within the framework of the redevelopment project of the site (service provided by SUEZ RR IWS REMEDIATION FRANCE in December 2015).
- Forced extraction of PCE present in the soils and in the gaseous state in the air from the soil between the final excavation slope (-3 m compared to the natural ground) and the roof of the limestone of Saint-Ouen (located approximately 8 m deep). The objective of this operation was not to achieve compatible residual risks (which had already to be reached after the excavation work carried out to a depth of 3 m) but to pursue the elimination of the pollution more in depth, with a view to improving the quality of the environments. The initial objective was to achieve an 80% reduction in the mass content of PCE determined in soil gases before the start of treatment with SVE. To achieve this goal, the SVE treatment was scheduled to work over a period of 3 to 6 months.

3. Pilot-scale application in field

We did not carry out a pilot sizing test prior to the implementation of the soil vapour extraction treatment.



4. Full-scale application

4.1 Extraction system

In view of the environmental, geological and hydrogeological context of the site, to treat the source of soil pollution in the area of the former chemical storage area of the CHIMICOLOR plant at La Garenne Colombes, the choice fell on the implementation of an in situ treatment by SVE. This technique had the most relevant technical and economic interest in meeting the objectives of a rapid improvement in the quality of the subsoil.

The forced extraction of gases from the soil was accomplished using 9 wells implanted up to 6 meters deep from the bottom of the excavation, including 2 m in solid tubes and 4 m in screened tubes.

This configuration was determined from the pollution and soil characterization data made available and using sizing assumptions such as:

- The absence of a surface coating (concrete or coated slab) in line with the impacted area;
- A soil permeability estimated at $5 \cdot 10^{-6}$ m/s;
- Unit extraction rates of 2 to 15 m³/h;
- A vacuum at the head of each well less than 150 mbar;
- A provisional treatment period of 6 months.

The unit has been sized so as to be able to ensure a maximum total extraction flow of 660 m³/h for a maximum total depression of 350 mbar, compatible with the assumptions stated above.

The installation of the treatment wells was carried out in such a way as to densify the footprint of the treatment wells in the area of the highest impact (premises for chemical etching, storage of products).

The plan below shows the location of SVE wells and treatment facilities.

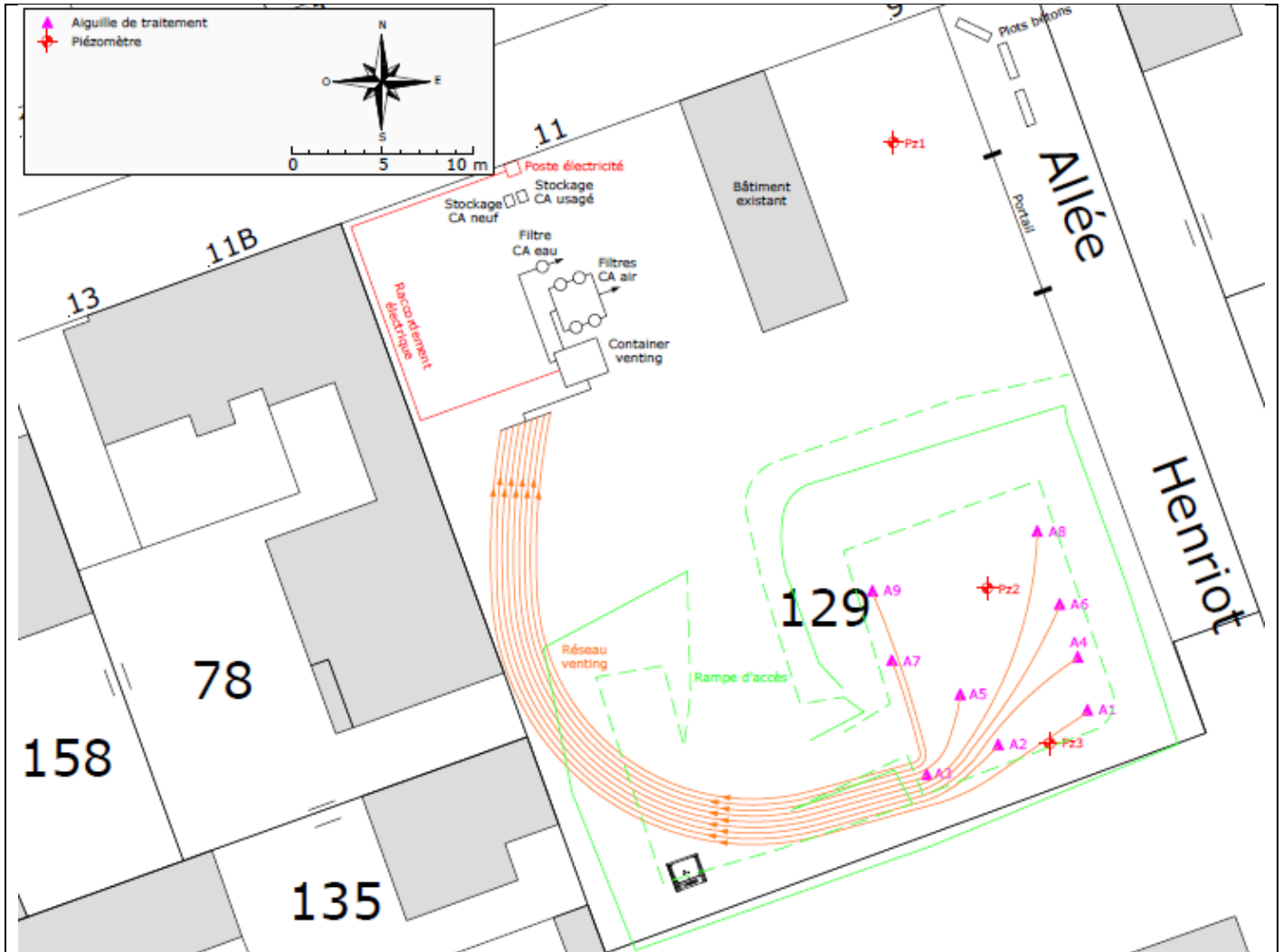

Layout plan for wells and facilities



Photograph of SVE treatment facilities



4.3 Radius of influence

Prior to the commissioning of the treatment, SUEZ RR IWS REMEDIATION FRANCE implemented SVE tests in order to determine the characteristics specific to each well (optimal depression/flow rate) and to estimate the permeability of the unsaturated zone to the areas to be treated and thus determine the radius of influence of each well. These data were intended to confirm the sizing of the installation and optimize its performance.

Two types of SVE tests were carried out:

- Staged tests;
- A so-called "long-term" test carried out for 30 hours.

Staged tests

The objective of a step-by-step test is to determine the optimum vacuum/flow rate pair of the wells. During these tests, the air from the ground was extracted in stages of increasing depressions ranging from 200 to 350 mbar recorded at the level of the extractor. Five successive stages lasting 15 minutes were performed for each hand.

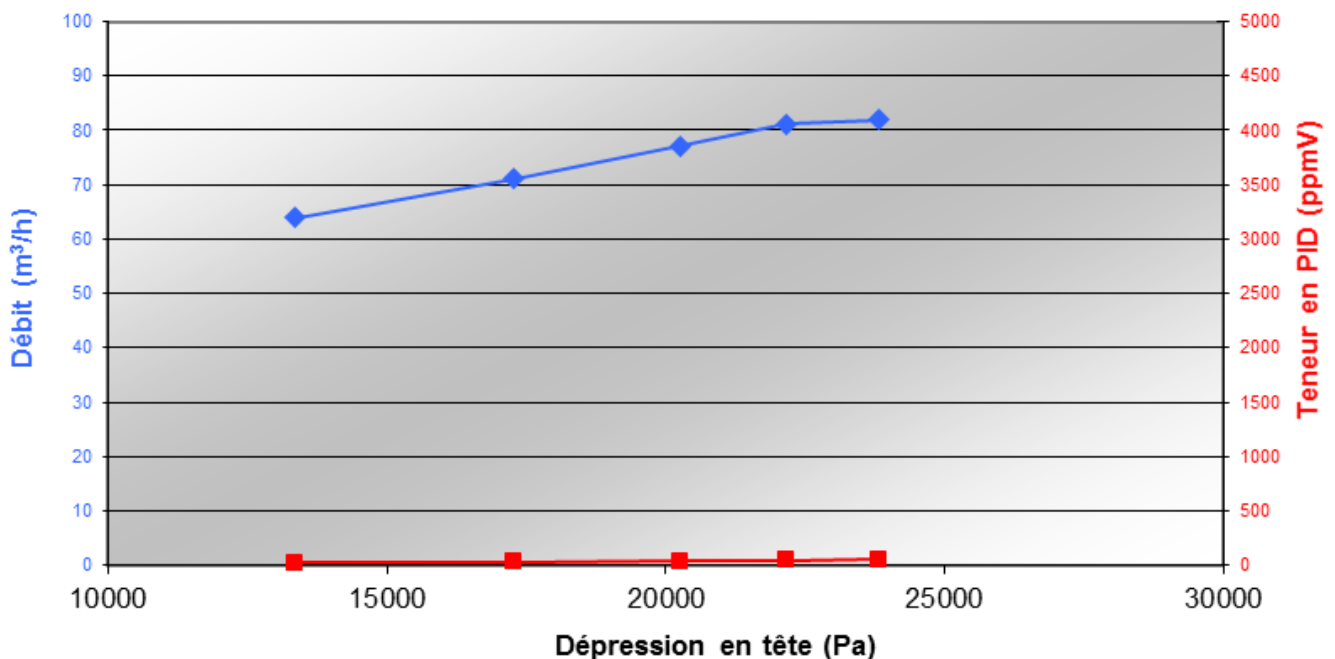

Vacuum/flow and vacuum/VOC content pairs for well A9

During the tests, regular monitoring (every 5 minutes) of the following parameters was



carried out:

- Extractor depression;
- Pressure difference in the flow measurement system (diaphragm device);
- Temperature, humidity and semi-quantitative VOC contents of the extracted gases.

For each well, vacuum/flow and vacuum/VOC content pairs could be determined. By way of example, the figure below corresponds to the depression/flow rate and depression/VOC content pairs measured from well A9.

The extraction flow rate increases steadily, going from 64 Nm³/h for a depression of 13.367 Pa to 81 Nm³/h with a depression of 22.167 Pa. From this last value, and despite an increase depression, the extraction flow hardly increases any more. For 23 833 Pa of depression, the observed flow rate is 82 Nm³/h. An asymptote is then observed. The optimum pressure/flow rate pair of the well is therefore of the order of 80 Nm³/h for a depression applied at the head of the structure of the order of 22.000 Pa. Well A9 is considered to be a productive well.

The semi-quantitative VOC contents in the gases extracted from this well are not very high compared to the other well tested. The minimum measured concentration is 24 ppmv at step 1 and the maximum concentration is 50 ppmv at step 5.

A summary of the measurements carried out at each well during the stepwise tests is presented in the table below. They correspond to the optimal extraction rate associated with a given depression.

Aiguilles	A1	A2	A3	A4	A5	A6	A7	A8	A9
Dépression optimale appliquée à l'ouvrage (mbar)	190	150	200	<140	240	200	190	230	220
Débit d'extraction optimal (Nm³/h)	57	37	44	40	43	36	41	41	81
Teneurs semi-quantitatives PID moyennes (ppmv)	623	429	143	3319	168	335	79	92	37

So-called "long-term" test

The advantage of the "long-term" test is that it can estimate the effective permeability



to air of the soils of the unsaturated zone in line with the zone to be treated. This parameter is essential for determining the radius of influence of each well under operating conditions.

The test was carried out on well A5 which was located in the centre of the area to be treated. The other 8 wells were located between 3.4 and 9.6 m from well A5. A fixed vacuum of 240 mbar was applied for 30 hours from well A5 and semi-quantitative measurements of VOCs and depressions were carried out at close frequency at the start of the test (every 5 minutes) and less frequently by thereafter, on each control well. The defined value of the applied vacuum (240 mbar) was determined by the step test. For well A5, the optimum depression is not known (it is less than 14,000 Pa). On the other hand, at such a depression, we were sure to apply to the well its optimum flow rate estimated at around 40 Nm³/h.

Estimation of effective air permeability

In order to determine the effective permeability to air of the treatment zone (k_a expressed in m² or permeability K expressed in m/s), various analytical solutions (more or less complex) are proposed in the literature. The configuration of the extraction well and the control wells of the area to be treated made it possible to use the adaptation of Dupuit's solution. This simplified relation derived from that for groundwater flow is used to represent the radial flow of air in steady state.

As the adaptation of Dupuit's solution was only valid in a steady state, the test was extended until the differential pressure values were obtained which were stable over time at the level of the control wells.

The calculated effective air permeability is 9.10⁻⁴ m/s. The value obtained is greater than the value used during sizing (5.10⁻⁶ m/s). This difference made it easier to reach the objectives by allowing more air volume to be extracted from the ground than expected.

Estimation of influence radii

By definition, the theoretical influence radius (R1000) of SVE wells corresponds to the radius in which the soil air (pore volume) is renewed at least 1000 times per year. The radius of influence depends on several factors including the geometry of the extraction system, the air permeability of the soil, the water content of the soil and the type of surface coating. Typically, R1000 can range from 2m (for fine soils) to 30m (for granular soils) for a single extraction well.

It should also be noted that the radii of influence of the wells are greater if the ground surface is waterproof (covered with bitumen or concrete), which is not the case in the treatment area of the CHIMOCOLOR site.

A calculation tool internal to SUEZ RR IWS REMEDIATION FRANCE makes it possible to

determine the estimated permeability values by taking advantage of the adaptation of Dupuit's solution. This same tool makes it possible to predict the extractable flow by considering the permeability value, the characteristics of the tested well (depth, length of the screened interval, etc.) and the depression applied at the head of the well. If the flow rate measured at the end of the long-term test is of the same order of magnitude as the calculated flow rate, then the estimated permeability value can be validated.

The results obtained at the end of the long-term test are presented in the table below.

Work	Applied depression	Estimated permeability	Measured extraction flow	Flow calculated according to permeability
AT 5	240 mbar	9.10^{-4} m/s	107.4 Nm ³ /h	168.1 m ³ /h

The permeability value estimated during the long-term test is consistent with regard to the nature of the soils (sands, marls, limestone).

The flow calculated from the permeability estimate is greater than the measured extraction flow (approximately 60 m³/h). The geology of the soils could suggest the presence of preferential flows. They are liable to vary the depressions at the head of wells and the unit flows. In addition, the flow rate of 107.4 m³/h measured during the "long-term" test is also greater than the flow rate of 43 m³/h measured on well A5 during the step tests. These two measured flow rates show the high productivity of well A5 and are much higher than the unit flow rates taken into account for the sizing (between 2 and 15 m³/h), which goes in the direction of better efficiency of the treatment.

The permeability thus obtained makes it possible to estimate the radius of influence of each well under operating conditions.

The table below compiles the values of the influence radius obtained under operating conditions of the SVE treatment.

Summary of the radius of influence calculated under operating conditions

Work	Depression applied at the well head (mbar)	Measured extraction flow (Nm ³ /h)	Radius of influence (m)
A1	27.8	29.9	7.1
A2	29.5	24.5	6.7
A3	32.3	33.8	7.3
A4	43.6	28.9	7
AT 5	28.2	32.1	7.2
A6	41.4	21.3	6.4
A7	36.5	31.0	7.1
AT 8	27.8	36.5	7.5
A9	27.6	28.5	7

The radius of influence obtained from the long-term test and the first operating data are between 6.4 and 7.5 m. Knowing that the maximum distance between two wells is 5 m, the calculated radius make it possible to validate the dimensioning of the SVE well network (number and positioning), namely a total coverage of the area of 250 m² in the south-eastern area of the site.

The mapping of the influence radius of SVE wells is presented in the following plan.

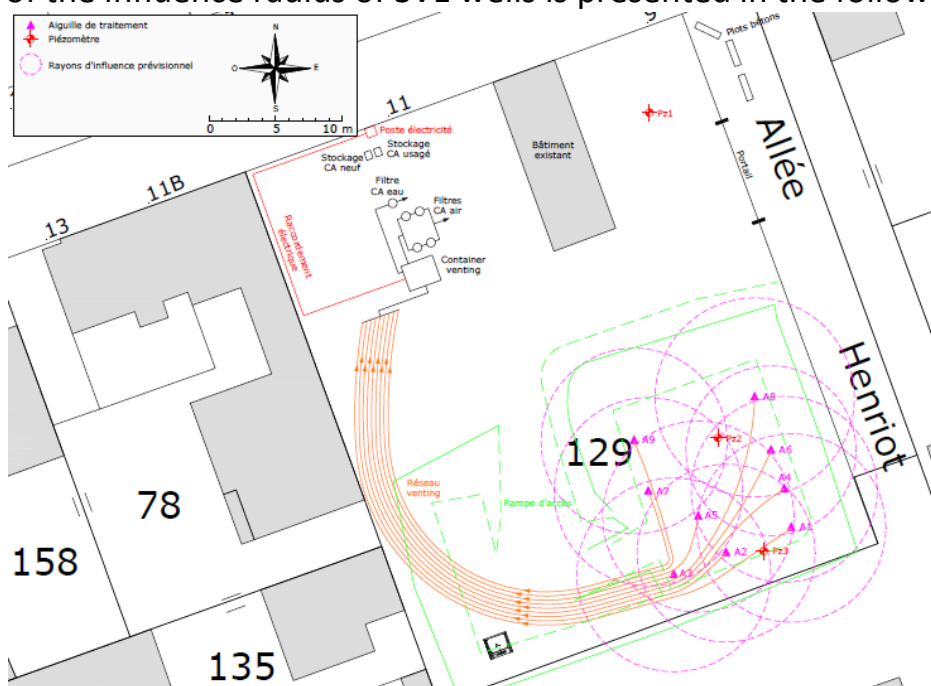



4.4 Off gas Treatment

The technical-economic analysis, based on the projected mass balance of the treatment, made it possible to demonstrate that the treatment of the gases extracted on activated carbon was the most economical solution, while allowing a significant reduction in the contents of volatile pollutants.

The initial choice of SUEZ RR IWS REMEDIATION FRANCE fell on a filtration line made up of two series of two 200-liter activated carbon filters arranged in parallel and connected in a common outlet (capacity of 80 kg of activated carbon per filter). When the activated carbon from the filters placed at the head reached saturation, said filters were emptied, tipped over at the end of the filtration line and then supplemented with healthy activated carbon. Such a device made it possible to measure the VOCs content in the air flow at the outlet of each barrel in order to effectively control the gaseous discharge into the atmosphere and free us from any exceeding of the limit value. In addition, this gaseous effluent treatment device guaranteed reduced downtime for the installation in order to change the activated carbon.

The contaminated activated carbon was evacuated to an approved treatment channel (hazardous waste storage facility).

4.5 Control parameters

The figure, below, presents in the form of histograms, the air extraction volume flow rates recorded during monitoring as well as the curve representing the evolution of the cumulative volume of extracted air during the period devoted SVE treatment.

Evolution of the extraction volume flow rates of the treatment unit and the total volume of extracted air

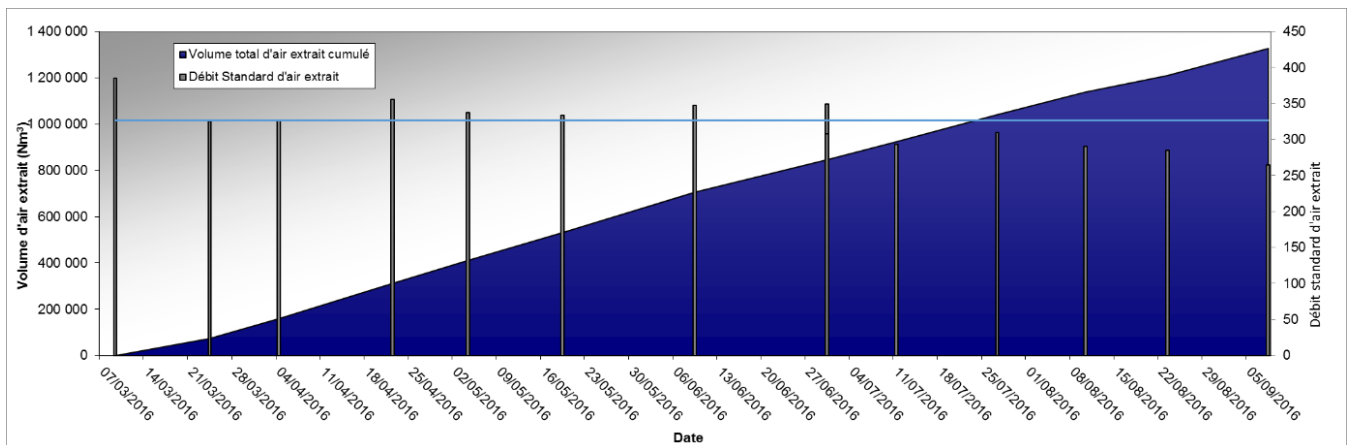

At the end of the operating period of the SVE unit:

- The average volume flow rate of air extraction estimated over the six months of operation is 327 Nm³/h (blue line shown in the figure above);
- The total volume of air extracted from the ground is estimated to be approximately 1,328,000 Nm³.

The figure below shows the evolution of the volume contents of VOCs measured by means of a photo ionization detector (PID) in the air flow extracted from each of the treatment wells as well as in the global air flow input to the unit during the operating period of the SVE treatment.

Evolution of the volume contents of VOCs in the air flow extracted from each treatment well

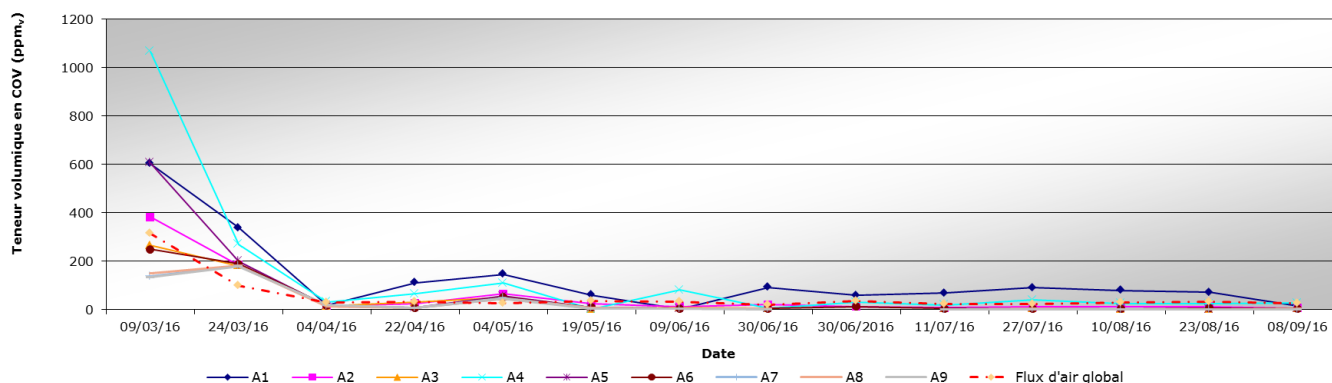

The volumetric VOC contents remained relatively stable after the significant decrease observed during the first month of treatment. After 6 months of treatment, the extracted air streams exhibited contents ranging between 1.1 ppmv for well A9 and 26.6 ppmv for well A4.

Monthly, air sampling, on a suitable sampling support (activated carbon tube) was carried out at the inlet of the activated carbon filtration device. This sampling made it possible to determine, through the performance of laboratory analyzes, the mass contents of VOCs in the overall air flow extracted from the ground via the treatment wells.

The table below compiles the analytical results obtained from the samples taken during the period devoted to SVE treatment.

Mass content of VOCs in the extract air flow

	09/03/2016	04/04/2016	04/05/2016	09/06/2016	11/07/2016	10/08/2016	08/09/2016
Unité	mg/Nm ³	mg/Nm ³	mg/Nm ³	mg/Nm ³	mg/Nm ³	mg/Nm ³	mg/Nm ³
1,2-dichloroéthane	<SQ	<SQ	<SQ	<SQ	<SQ	<SQ	<SQ
1,1-dichloroéthène	<SQ	<SQ	<SQ	<SQ	<SQ	<SQ	<SQ
cis-1,2-dichloroéthène	<SQ	<SQ	<SQ	<SQ	<SQ	<SQ	<SQ
trans 1,2-dichloroéthylène	<SQ	<SQ	<SQ	<SQ	<SQ	<SQ	<SQ
dichlorométhane	<SQ	<SQ	<SQ	<SQ	<SQ	<SQ	<SQ
1,2-dichloropropane	<SQ	<SQ	<SQ	<SQ	<SQ	<SQ	<SQ
1,3-dichloropropène	<SQ	<SQ	<SQ	<SQ	<SQ	<SQ	<SQ
tétrachloroéthylène	1490,8	193,6	107,4	101,0	66,6	74,2	99,2
tétrachlorométhane	<SQ	<SQ	<SQ	<SQ	<SQ	<SQ	<SQ
1,1,1-trichloroéthane	0,7	0,2	0,1	0,1	0,1	0,1	0,6
trichloroéthylène	2,0	0,3	0,1	0,1	0,1	0,1	0,2
chloroforme	<SQ	<SQ	<SQ	<SQ	<SQ	<SQ	<SQ
chlorure de vinyle	<SQ	<SQ	<SQ	<SQ	<SQ	<SQ	<SQ
hexachlorobutadiène	<SQ	<SQ	<SQ	<SQ	<SQ	<SQ	<SQ
bromoforme	<SQ	<SQ	<SQ	<SQ	<SQ	<SQ	<SQ
TOTAL COHV	1493,5	194,1	107,6	101,2	66,7	74,4	100,0
Teneur PID lors du prélèvement	315,0	32,1	26,0	27,0	28,0	29,0	30,0
Pourcentage d'abattement sur les COHV totaux par rapport au 09/03/2016	NA	87%	93%	93%	96%	95%	93%



<SQ: below the quantification threshold

NA: Not applicable

During the follow-up on September 8, 2016, i.e. before stopping the treatment device, the tetrachlorethylene content (a compound present at 99% in the air flow since the start of the treatment) had significantly increased compared to the levels determined from the samples from July 11 and August 10, 2016.

The total COHV content determined during the monitoring of September 8, 2016 was 100 mg/Nm³ and revealed a reduction percentage of 94% compared to the content measured on March 9, 2016, the day treatment was started.

An indicative value of the total mass of pollutants extracted could be calculated on the basis of analytical monitoring and air volumes extracted from the soil by the SVE system. The calculations only take into account the organic compounds analyzed.

The table below shows the detail of the estimate of the masses of VOCs extracted from the ground, in gaseous form, by the SVE device, on the basis of the data collected from the start of the treatment until its stop, the September 08, 2016. The average concentration over each period was calculated from the two air samples taken at the inlet of the activated carbon filters and limiting the monitoring period.

Mass balance of pollutants extracted from the ground by the SVE device since the start of treatment

Paramètre	Unité	1 ^{er} mois de suivi	2 ^{ème} mois de suivi	3 ^{ème} mois de suivi	4 ^{ème} mois de suivi	5 ^{ème} mois de suivi	6 ^{ème} mois de suivi
		Du 09/03/2016 au 04/04/2016	Du 04/04/2016 au 04/05/2016	Du 04/05/2016 au 09/06/2016	Du 13/06/2016 au 11/07/2016	Du 11/07/2016 au 10/08/2016	Du 10/08/2016 au 08/09/2016
Volume d'air extrait période	Nm ³	158 680	251 512	294 716	217 678	216 489	188 984
Concentration moyenne en COHV sur la période (échantillonnage mensuel)	mg/Nm ³	843,8	150,8	104,4	84,0	70,6	87,2
Masse totale en COHV extraite période	kg	134	38	31	18	14	16
Taux d'extraction journalier	kg/j	5	1	1	1	0,5	0,6
Masse totale extraite cumulée	kg	134	172	203	221	235	251

As of September 8, 2016, the date of termination of the SVE treatment system, it is estimated that approximately 251 kg of VOCs were extracted from the soils in gaseous form.

6. Post treatment and/or Long Term Monitoring

6.1 Post treatment and/or Long Term Monitoring

Following the six months of treatment and in accordance with the acceptance strategy for the decontamination works, a statement of the quality of the soil gases was carried out monthly for 3 months from each treatment well in order to quantify the level of pollution. of soil gases by VOCs and to monitor the possible evolution of the levels, once the device has been shut down.

Evolution of the volume contents of VOCs in static conditions from the initial state (09 March 2016) until the last monitoring campaign of the reception phase (06 December 2016)

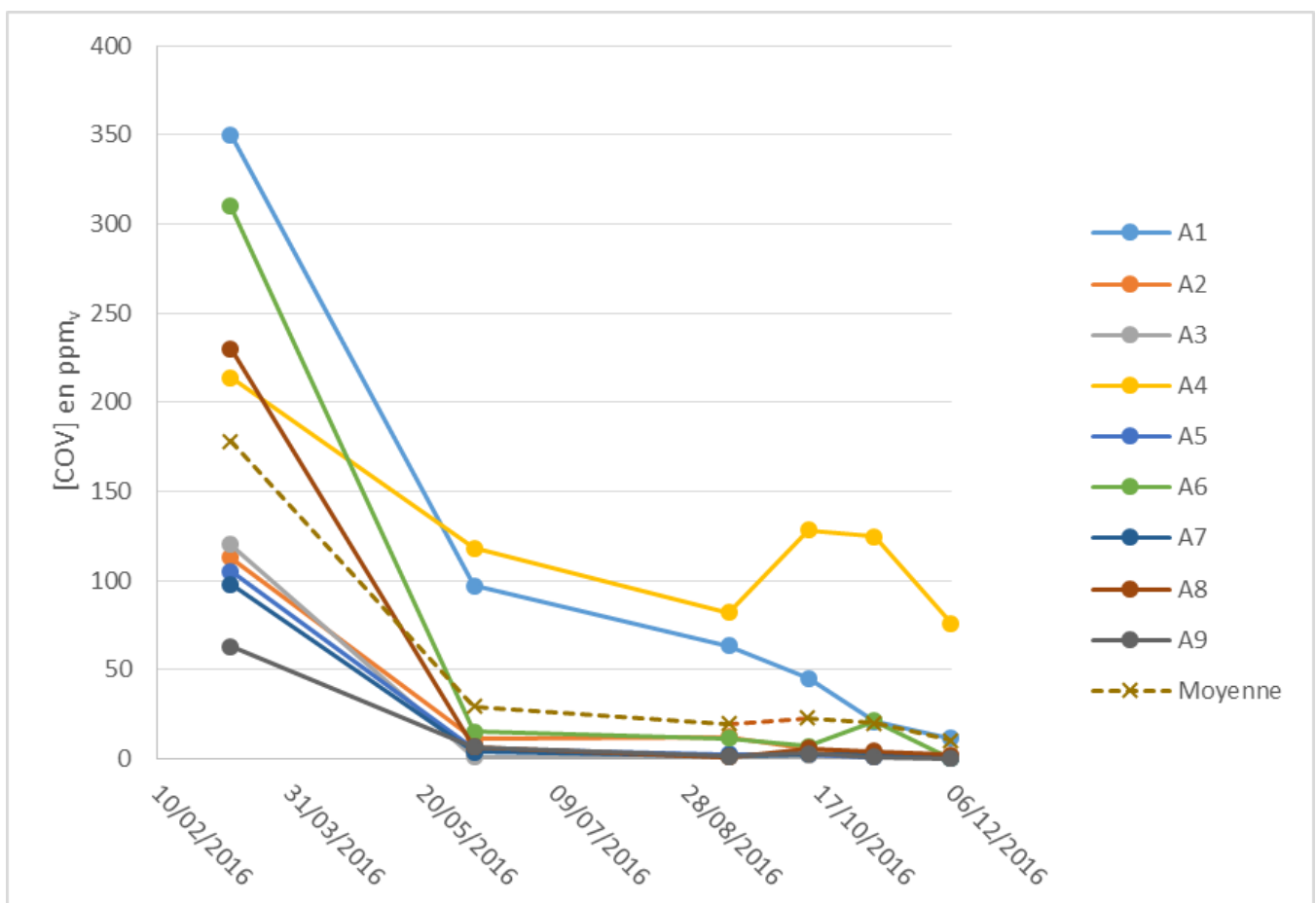

Evolution of the VOC mass contents under static conditions from the initial state (09 March 2016) to the last monitoring campaign of the reception phase (06 December 2016)

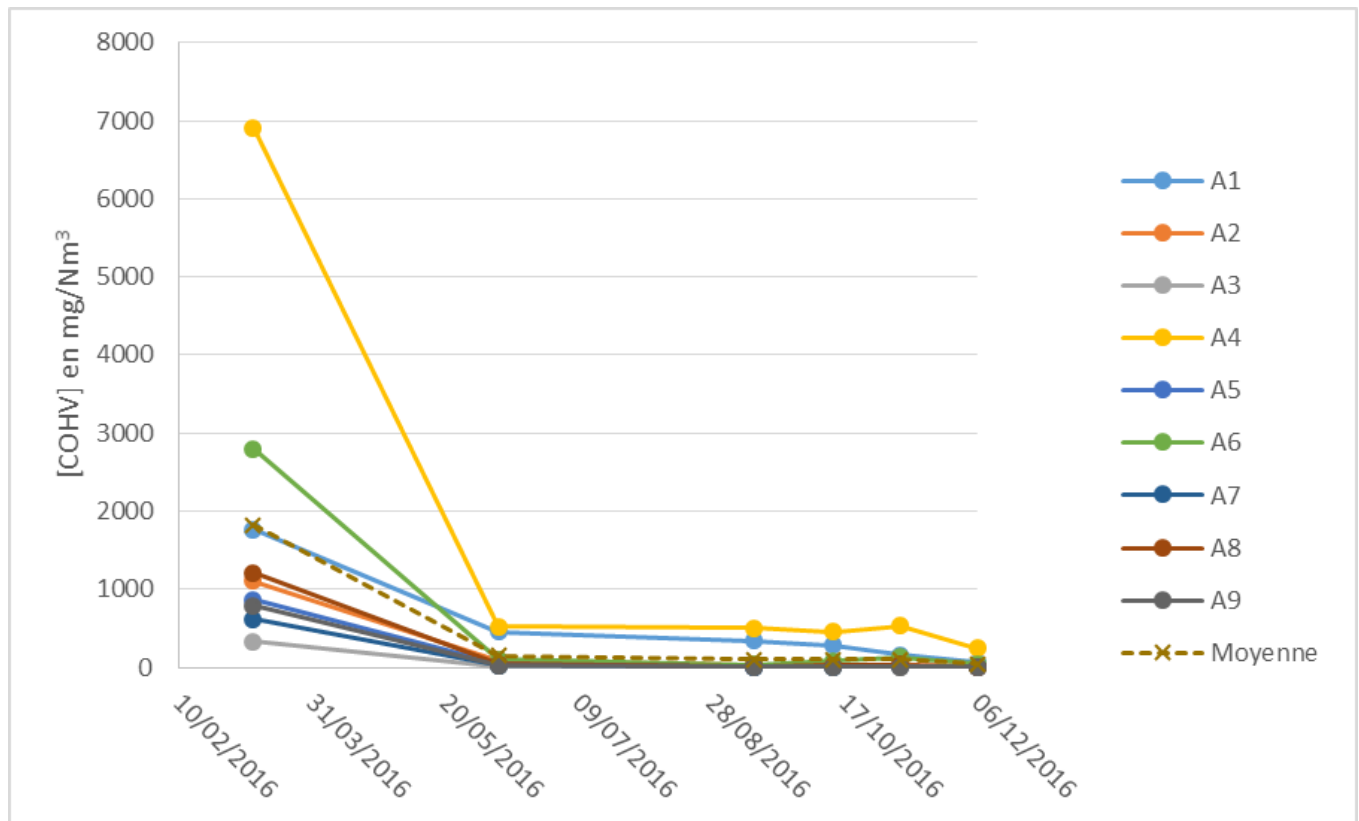

After 6 months of treatment, the average VOC content in the soil gases sampled from the 9 SVE wells was 108.23 mg/Nm³. This value remains relatively high. Despite everything, in comparison with the value obtained before the start-up of the installations, the reduction rate of the average of the total VOC contents amounts to 94%. The results obtained demonstrated good efficacy of the treatment.

The VOC contents in the soil gases sampled from each of the 9 wells ranged, after 6 months of treatment, between 3.04 mg/Nm³ for well A3 and 507.36 mg/Nm³ for well A4. All the wells exhibited an abatement rate greater than 93%, with the exception of well A1 which exhibited an abatement rate of 81% for a measured concentration of 338.04 mg/Nm³.

The treatment of soil gases by SVE was stopped at the end of the soil gas sampling campaign carried out on September 13, 2016, in accordance with the work acceptance strategy. The operating mode consisted of keeping the installation shut down for a period of 3 months. During this period, and in a manner identical to the samples taken



during the initial state and after 3 and 6 months of treatment, soil gas samples at the 9 wells were taken and analyzed on a monthly basis.

After 3 months of stopping treatment, the average VOC content in the soil gases sampled from the 9 SVE wells was 42.86 mg/Nm^3 . This value is lower in comparison with the value obtained after stopping treatment, on September 13, 2016 and in comparison with the values obtained after one and two months of stopping, on October 13 and November 7, 2016. In the end, the reduction rate for the average VOC content is 98%, which corresponds to a significant reduction rate, clearly higher than the target (80%). The VOC contents in the soil gases sampled from each of the 9 wells range, after three months of shutdown, between 1.97 mg/Nm^3 for well A9 and 245.04 mg/Nm^3 for well A4. All the wells had an abatement rate greater than 97%.

At the end of the final soil gas quality monitoring campaign carried out on December 6, 2016, tetrachlorethylene still remains the majority compound. We can also note that 1,1,1-trichloroethane was measured in trace amounts at wells A4, A5, A6 and A8. Likewise, trichloroethylene was also measured in trace amounts in the area of wells A1, A4, A5, A6, A8 and A9.

1. Contact details - CASE STUDY: SVE n.9

1.1 Name and Surname	VION Mathieu (Expert at Technical Direction) DEVIC-BASSAGET Boris (Technical Director)
1.2 Country/Jurisdiction	FRANCE
1.3 Organisation	SUEZ RR IWS REMEDIATION FRANCE
1.4 Position	Head Office : 17 rue du Périgord, 69330 Meyzieu (France)
1.5 Duties	Engineer - Expertise department manager
1.6 Email address	mathieu.vion@suez.com ; boris.devic-bassaget@suez.com contact.remediation.europe@suez.com
1.7 Phone number	+33(4)72450222



2. Site background

2.1 History of the site

The site where the SVE clean-up project was carried out is confidential.

The site is located in the Ile-de-France region, in France. The site covers an area of several hectares and corresponds to a multidisciplinary research and innovation centre. The activities carried out concern many fields such as nuclear energy, life sciences, material sciences, climate and environment, technological research and education. The area of the site mainly affected by the presence of VOCs (mainly trichloroethylene – TCE) in the subsoil is located in the extreme south-eastern part of the centre.

2.2 Geological setting

The geological and hydrogeological information collected during the previous studies are reported in the following table.

Geological information	Hydrogeological information
<p>The horizons intersected by the wells on site are successively:</p> <ul style="list-style-type: none"> • a very poorly permeable cover formation, corresponding to plateau silts and grindstone clays, with a thickness of around 12 m; • the Fontainebleau sands, corresponding to very well classified fine sands (particle size of 500 to 600 μm); the thickness of Fontainebleau sands formation is around 50 m; a carbonate and clayey horizon, with a thickness generally between 1 and 2 m, is present in the upper part of the Fontainebleau sands formation, at a depth of the order of 14 to 15 m. 	<p>Aquifers: formation of the Fontainebleau sands</p> <p>Static level: the free surface of the water table is intercepted at a depth of 40 m.</p> <p>Flow direction/gradient: the flow of the groundwater table is directed towards the south</p> <p>Hydrodynamic data: no data is available</p>



2.3 Contaminants of concern

Under the effect of the diffusion within the Fontainebleau sands, which are very permeable to air and which are isolated from the atmosphere by a confining geological layer of a dozen meters thick, a halo of VOCs (mainly trichloroethylene - TCE) was formed within the pore space of the Fontainebleau sands, in the sector of the main source zone identified, that is to say in the extreme south-east of the site.

The TCE halo partially dissolves on contact with groundwater. The plume of VOCs, multi-source and multi-pollutant, affects groundwater at the scale of the site.

Pollution characterization data remain unknown, namely:

- the position of the historical area of solvent infiltration in the subsoil;
- The nature and quantities of the VOCs that have reached the subsoil;
- the nature of the polluting events that led to the infiltration of VOCs into the subsoil.

2.4 Regulatory framework

The main objective of the client is to improve the quality of groundwater and overall improve the quality of the underground environment, with a view to reducing the sources of pollution of the underground environment in accordance with the French national methodology for the rehabilitation of sites and soils polluted.

To achieve this, the client commissioned the company SUEZ RR IWS REMEDIATION FRANCE to carry out the forced extraction of TCE present in the gaseous state in the air from the soil between 15 and 40 m deep, within the Fontainebleau sands formation, in the south-eastern part of the site.

3. Pilot-scale application in field

We did not carry out a pilot sizing test prior to the implementation of the soil vapour extraction treatment.

4. Full-scale application

4.1 Extraction system

The forced extraction of gases from the ground was accomplished from the three wells named F51, PG-05 and PG-08. These wells are respectively 50 m, 20 m and 30 m deep in relation to the surface. The screened intervals of these wells intercept the Fontainebleau sands. The treatment unit was dimensioned so as to be able to ensure a maximum extraction flow rate per well of the order of 150 to 200 m³/hour. In addition, given the configuration of the screened intervals of the PG-05 and PG-08 wells, SUEZ RR IWS REMEDIATION FRANCE has provided specific plugs and wellheads in order to selectively extract gases from the soil in the Fontainebleau sands formation overlying or underlying the carbonate and clay horizon generally intersected between 14 and 16 m deep.

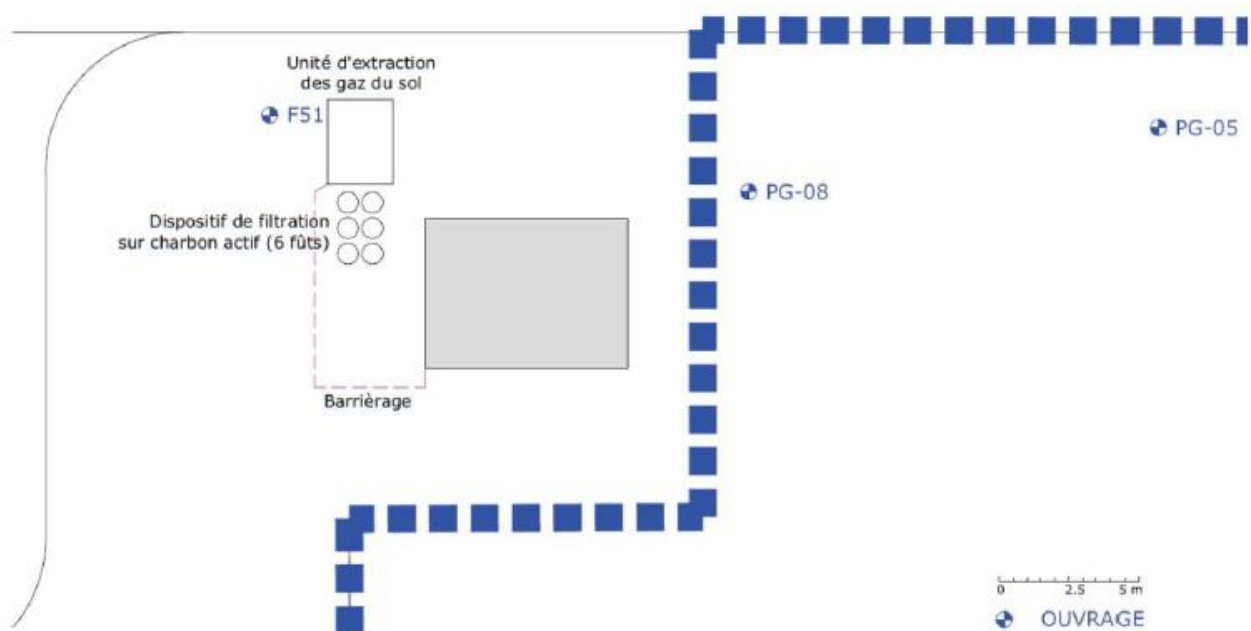

Layout plan for wells and facilities

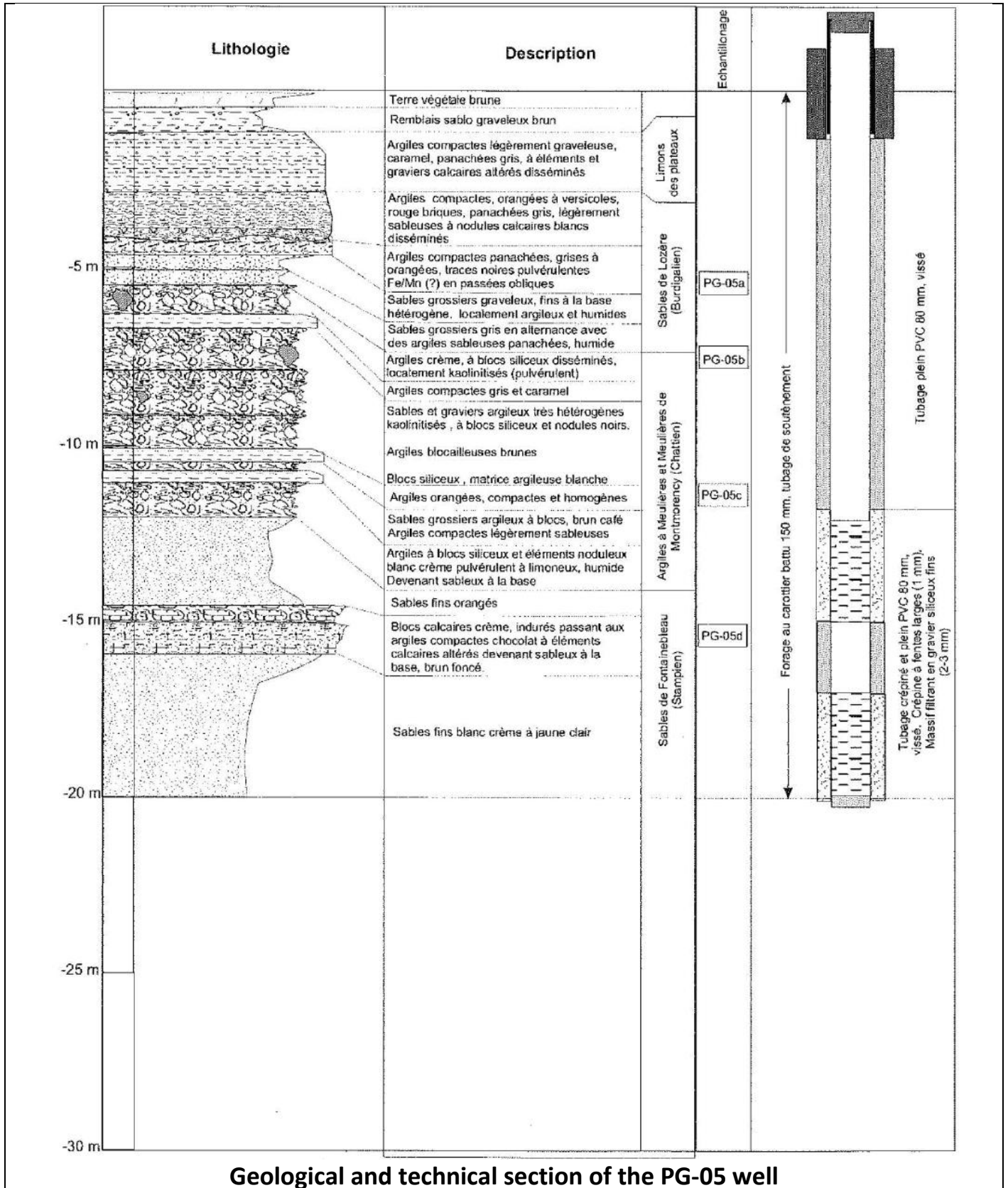

Geological and technical section of the PG-05 well



4.3 Radius of influence

We did not determine the radius of influence of the treatment wells in the context of this project.

4.4 Off gas Treatment

The technical-economic analysis, based on the forecast mass balance of the treatment, has shown that the treatment of gases extracted on activated carbon is the most economical solution, while allowing a significant reduction in the content of volatile pollutants.

The choice of SUEZ RR IWS REMEDIATION FRANCE fell on two parallel filtration lines, each of the lines being made up of three 200-liter activated carbon filters arranged in series (capacity of 75 kg of activated carbon per filter). When the activated carbons from the two drums placed at the head reached saturation, said drums were emptied, tipped at the end of their respective filtration line and then supplemented with healthy activated carbons. The soiled activated carbons were packaged in big bags. Each big-bag will be completed with 400 to 600 kg of activated carbon.

The VOC content in the air flow at the outlet of each drum has been measured to effectively control the gaseous discharge to the atmosphere and to avoid any exceeding of the discharge criteria.

4.5 Control parameters

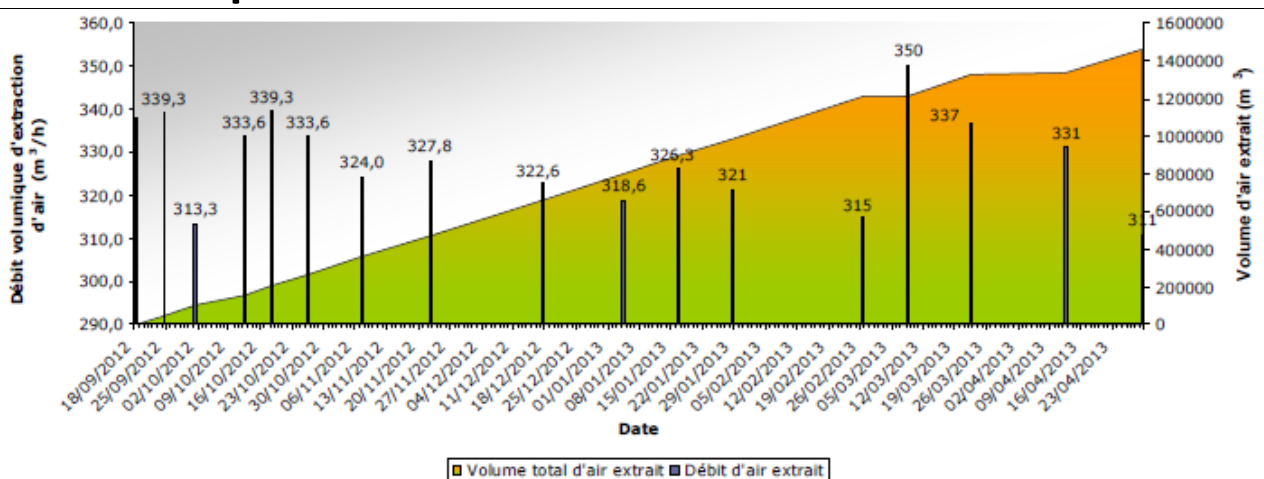

Evolution of the extraction volume flow of the treatment unit and the total volume of air extracted from the ground

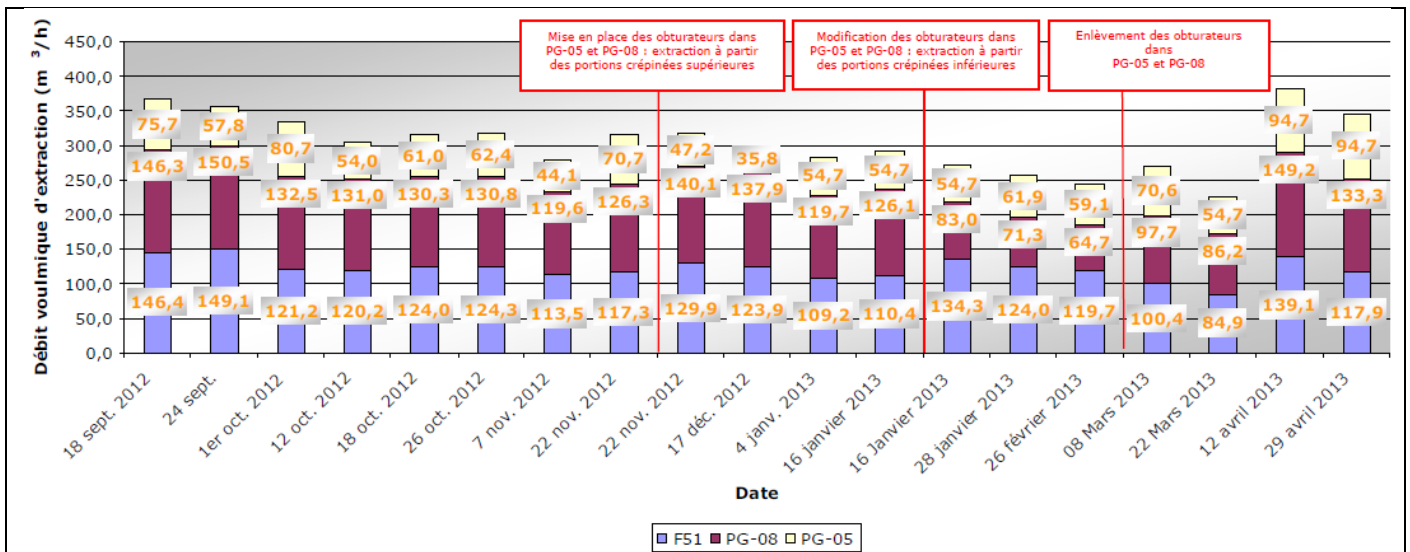

Evolution of the air extraction volume flow of each treatment well

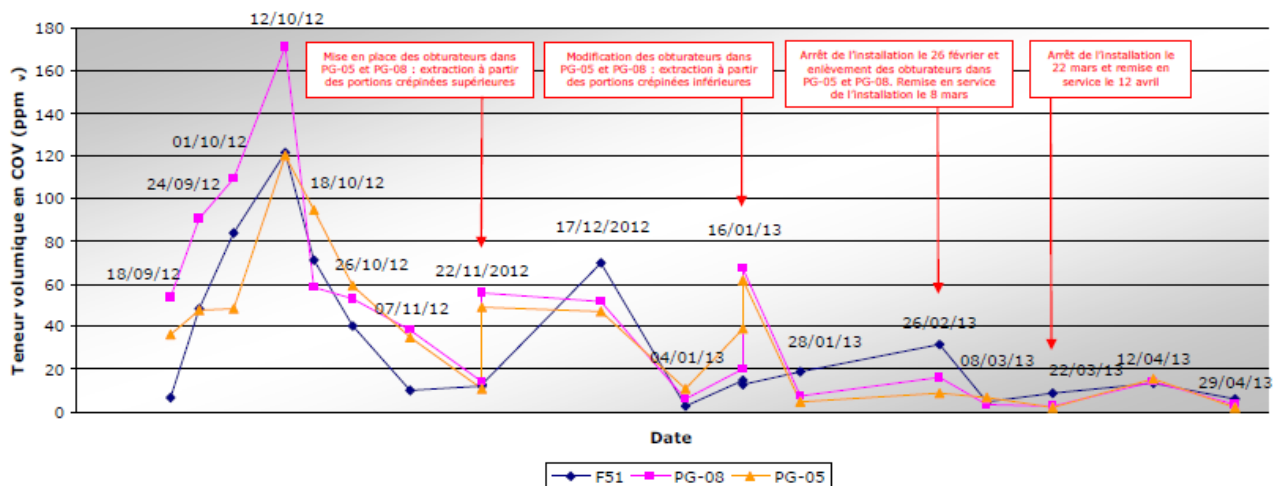

Evolution of the volume contents of VOCs in the air flow extracted from each treatment well

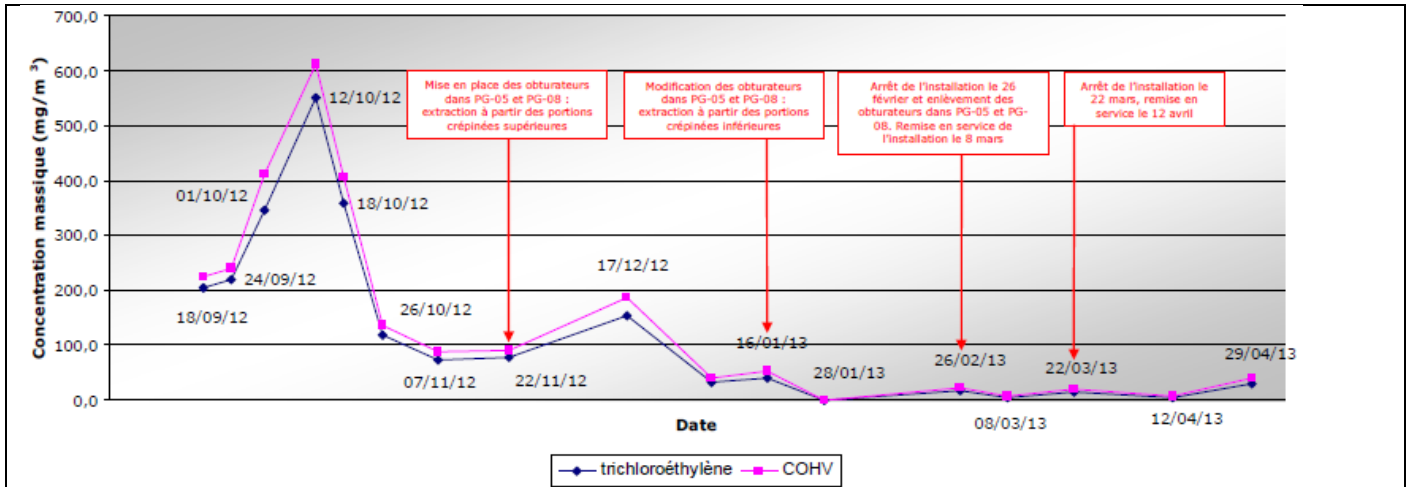

Evolution of the mass content of trichlorethylene in the air flow extracted from the ground

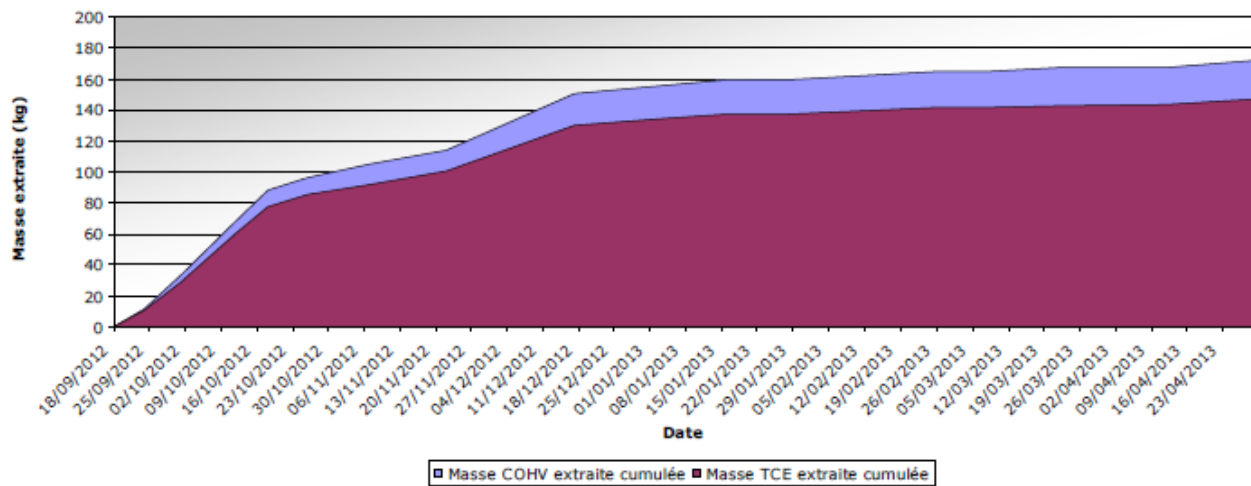

Evolution of the masses of VOCs and TCE extracted from the ground by the soil vapor extraction treatment, according to analytical monitoring



5. Enhancements to SVE

5.2 Any other enhancement

Apart from the use of shutters and specially designed well heads during treatment for the PG-05 and PG-08 wells (as a reminder, in order to carry out a selective extraction of gases from the soil in the Fontainebleau sands formation overlying or underlying the carbonate and clay horizon generally intersected between 14 and 16 m deep), SUEZ RR IWS REMEDIATION FRANCE has not implemented other improvements to the SVE system.

7. Additional information

7.1 Lesson learnt

Controlled project, without particular constraints to be met. The SVE treatment made it possible to achieve the asymptote of recovery of TCE in the horizon of the Fontainebleau sands. The client did not communicate to SUEZ RR IWS REMEDIATION FRANCE the analytical results from the groundwater monitoring but had nevertheless shared the information that the quality of the groundwater at the level of the piezometer located directly downstream of the treatment zone was improved.

1. Contact details - CASE STUDY: SVE n.10

1.1 Name and Surname	Simone De Fazio ¹ – Corrado Thea ²
1.2 Country/Jurisdiction	Italy
1.3 Organisation	Golder Associates S.r.l.
1.4 Position	¹ Geologist – ² Environmental engineer
1.5 Duties	Italian Environmental laws (D.Lgs 152/06)
1.6 Email address	sdefazio@golder.it – cthea@golder.it
1.7 Phone number	+39 011 2344200

2. Site background

2.1 History of the site

The Site is an ex industrial plant operating from the '50s to 2009, when it has been re-located because the area has become almost completely residential.

The remediation procedure for the Site started at the beginning of the 2000s, because a facility downstream from the Site was found to be impacted by an incoming chlorinated solvents contamination. Since 2000 soil and groundwater were largely investigated and a remediation activity was performed from 2011 to 2013.

In 2017 pilot tests were undertaken in order to address the PCE contamination detected in soil and groundwater. The selected technologies are Enhanced Reductive Dechlorination for GW and SVE for soil. Due to good results achieved in pilot tests, a full scale remediation was performed at the beginning of 2019 and it's still ongoing.



Site Aerial map with monitoring wells

2.2 Geological setting

Site soil consists of gravel and sand, interbedded with thin layers of sandy silt. The depth to groundwater is approximately 20 meters below ground surface (bgs).







2.3 Contaminants of concern

The main contaminant is tetrachlorethylene (PCE), detected in soil and groundwater. Trichloroethylene (TCE), 1,2 dichlorethylene (1,2-DCE) and Vinyl chloride (VC) are also present, as PCE degradation products.

In soil PCE was detected in concentration of about 1000 mg/kg. PCE in soil gas was up to 4900 mg/m³.

The remediation target for the Site was calculated by a human health risk assessment and for the soil matrixes is a soil gas target (because of the vapour inhalation risk) and it is equal to 110 mg/m³ for PCE, at the sub slab pins installed underneath the building and 2000 mg/m³ at the soil gas probes installed outdoor.

2.4 Regulatory framework

The main environmental law in Italy is the Legislative Decree no. 152/2006 (D.Lgs 152/06) that in Part four, Title fifth sets specific rules for remediation of contaminated sites.

The reference legislation establishes some threshold values (CSC D.Lgs 152/06 and limits DM31/15) for the main contaminants both in soil and groundwater; if during the characterization there are one or more exceedance of threshold values, the site is defined "potentially contaminated", and a human health risk assessment can be developed to estimate the risks deriving from the potential sources of contamination detected on site (defined by the samples with exceedance) and to calculate risk-based site-specific threshold limits (CSR). The legislature also fixes which are the values of acceptable risk for the assessment.

If the estimated risks are lower than acceptable values, the site is defined "not contaminated", and no remediation is needed. If the estimated risks are higher than acceptable values, the site is defined "contaminated", and remediation is needed. The risk based site-specific threshold limits (CSR) are the remediation targets.



3. Pilot-scale application in field

3.1 Extraction system

A SVE pilot test was performed in a not vertical well drilled with a 10° plunge (from vertical), up to 16.5 m bgs, right underneath the underground tank that were the primary contamination source; the screened interval is positioned from 8 m to 16.5 m bgs, to target the residual contamination below the source area as indicated by previous investigations.

The test was conducted connecting the well (SVEa) to a blower and then applying a vacuum on the extraction well. Vapor flow rate, vacuum and VOC, O₂, CO₂ and CH₄ concentrations were measured in the extraction well and in 4 nearby soil gas probes. A stepped rate test and a constant rate test was conducted on the test well. In the stepped rate test, each step was carried out for 30 minutes, at increasing flow rates (70, 95, 124 and 164 m³/h). During the constant rate test the maximum flow rate (164 m³/h) was used for a longer time (300 minutes).

Vacuum and VOC, O₂, CO₂ and CH₄ concentration measured in soil gas probes was used to assess the Radius of Influence (“ROI”) of the SVE.

3.5 Control parameters

Vapor flow rate, vacuum and VOC, O₂, CO₂ and CH₄ concentrations were measured in the extraction well and in 4 nearby soil gas probes during the test.

In the graph below the VOC measured during the constant rate test. 5000 ppm is the over range value of the field gas detector.

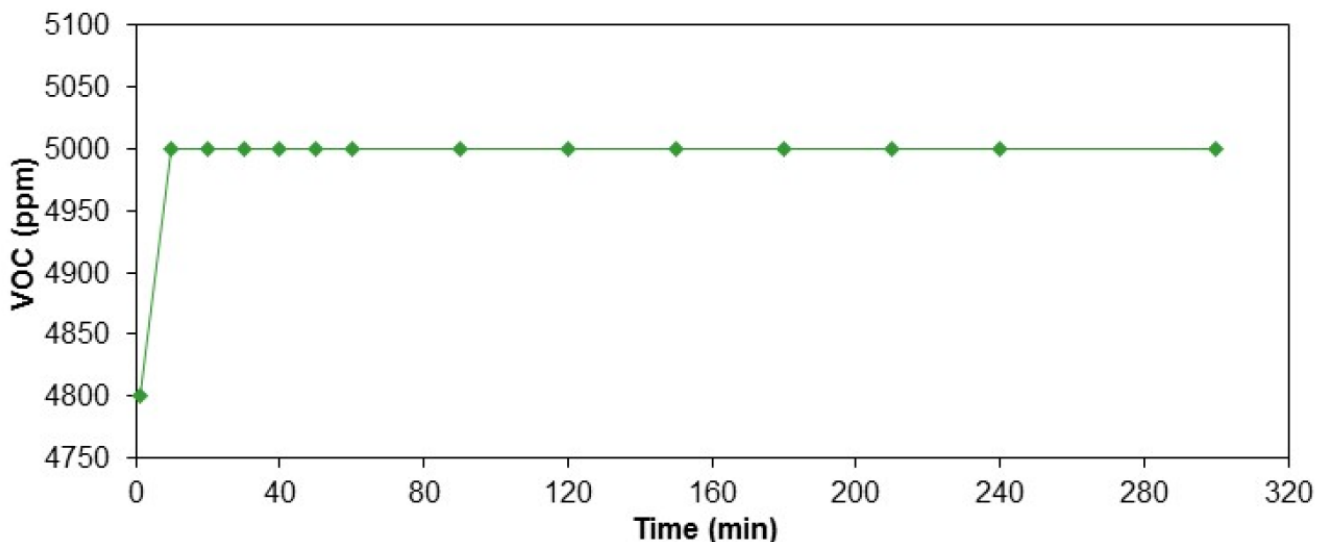

4. Full-scale application

4.1 Extraction system

The SVE system used included the following equipment:

- 1 non vertical well (SVEa), 3" in diameter, 16 m b.g.s. deep, 10° inclination;
- 3 vertical wells (SVEb÷SVEd), 3" in diameter, 9 m b.g.s. deep and located 12.5 m one from the other;
- 3 venting trenches, about 30 m long, located at 1 m bgs under the building basement floor and with a 7 m distance one from the other; each trench is composed by a HDPE pipe, screened, 4" in diameter, draining gravel, a protection sand layer and concrete;
- a blower and related vessels and piping, connected to a vapour treatment unit,
- vapour treatment unit composed of 3 Granular Activated Carbon ("GAC") filters.
- In addition, a HDPE vapour membrane was installed in the basement of the building to prevent subsoil vapour intrusion in the building basement and to increase the effectiveness of SVE action.

The schematic of the extraction venting trench is below.

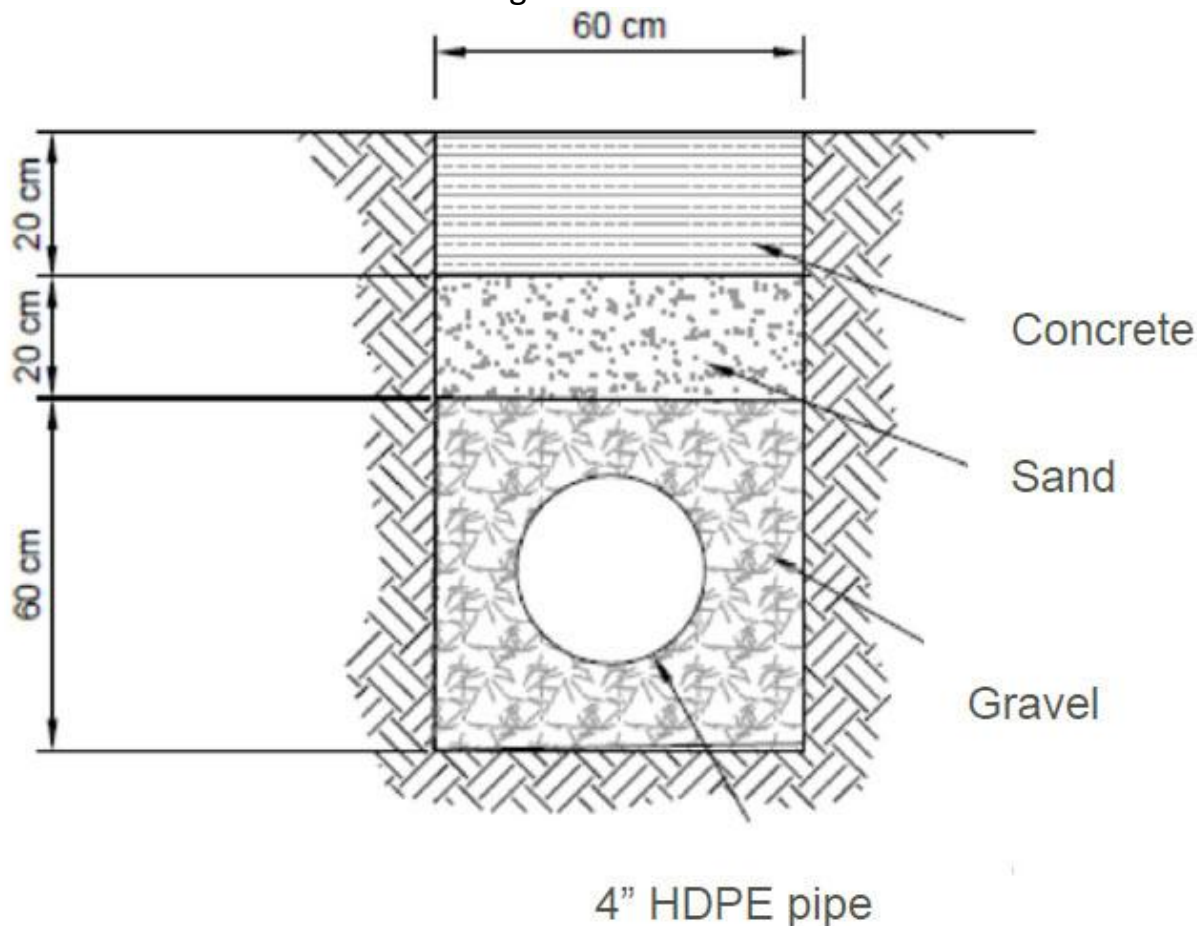

4.3 Radius of influence

Radius of influence (ROI) was calculated on the basis of induced vacuum and the pilot test results. The extracted flow is different for each extraction well in order to achieve the desired ROI: about 11-14 meters SVEa, about 7 meters SVEb-d.



4.4 Off gas Treatment

Activated carbon adsorption was used to remove all contaminants from the air stream; filters consist in 3 iron tanks, 150 cm high (270 cm with legs), 127 cm diameter, containing 800 kg of GAC each, connected in series.

The replacement of the GAC is scheduled based on the routine monitoring of VOC at the inlet and outlet of the system (see Chapter 4.5).

Off gas monthly monitoring at GAC filters outlet showed 0 ppm values over all the operational period, thus confirming the effectiveness of the off-gas treatment.



4.5 Control parameters

In addition, the SVE system has been equipped with a device that allows the continuous remote control of the operating parameters.

The PCE concentration decreased of 1 to 2 order of magnitude after 1 year of operation of the system and now is less than 10 ppm. Soil gas concentrations achieved remediation goal in all monitored soil gas probes.

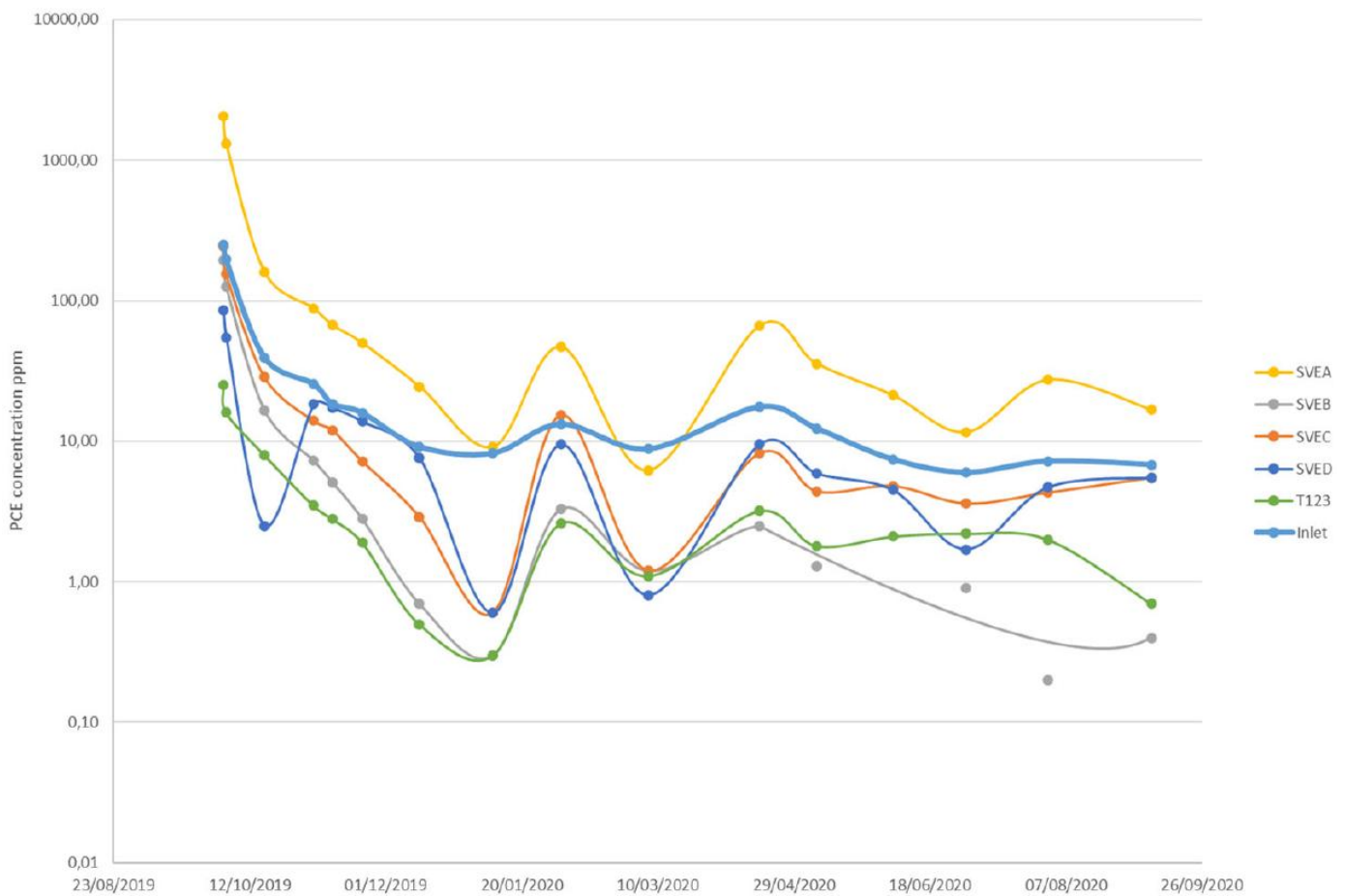



6. Post treatment and/or Long Term Monitoring

6.1 Post treatment and/or Long Term Monitoring

In compliance with the Remediation Plan, the SVE system was operated for 12 months up to asymptotic concentrations. After the shutdown of the system soil gas and sub slab sampling round was undertaken in order to verify the effectiveness of the SVE operation; further sampling campaigns are planned biannually for 2 years to confirm the reduction of the contaminants concentration in soil gas.

Results of the first soil gas and sub slab sampling undertaken after shutting down the SVE system showed concentrations below detection limits in all samples.

7. Additional information

7.1 Lesson learnt

During the remediation design it was invested in understanding deeply the Site Conceptual Model and in particular the secondary source; thus the remedial action targeted specifically and successfully the impacted source.

1. Contact details - CASE STUDY: SVE n.11

1.1 Name and Surname	Valentina Sammartino Calabrese
1.2 Country/Jurisdiction	Italy
1.3 Organisation	ARPA Campania
1.4 Position	Technical Collaborator
1.5 Duties	
1.6 Email address	
1.7 Phone number	

2. Site background

2.1 History of the site

The area is located on the eastern outskirts of the city of Naples, in an area characterized by a high population density and the presence of numerous industrial activities, most of which are abandoned. In particular, there are hydrocarbon management activities, dedicated almost exclusively to storage, as refining activities have now ceased, manufacturing industry, engineering, production of services. The area is located within the Eastern Naples SIN, established in 1998.

There is a protocol for the entire area of the SIN "Program agreement for groundwater remediation" which provides that the P.A. takes over the remediation of the groundwater in place of the responsible parties who adhere to it (once the health risk for workers is excluded).

There are also technical protocols for environmental characterization activities developed by the PA.

In the past, the site was annexed to a large fuel storage area, currently it carries out storage and sale of automotive fuels.





2.2 Geological setting

the stratigraphic structure of the area can be schematized as follows:

- from 0.0 to approx. 2.0 ÷ 3.0 m depth: heterogeneous fill soil, with sandy and gravelly granulometry
- from approx. 2.5 ÷ 3.0m at about 5.0m depth: sandy silt and silt, cohesive
- from 4.0 ÷ 5.0m to 12.0m depth: sand, subjected to a silty level

There is an exchange between the superficial and the deep aquifer with an active underground water circulation. The structure of the aquifer is very complex: the pyroclastic and sedimentary materials that constitute it present continuous granulometric variations both in the areal and vertical sense.

The consequence of the granulometric heterogeneity and the permeability characteristics of the soils present is the difficult identification of low permeability levels with sufficient continuity to divide the aquifer into several distinct layers. The pitch therefore tends to be typed in several levels, corresponding to coarse and variously interconnected materials, but always maintaining a unique character. The current subsidence, in most of the territory under examination, is less than 3-5 m from the ground level.

Contamination affects both the unsaturated and saturated phase of the subsoil.



2.3 Contaminants of concern

SOIL CONTAMINATION CONCENTRATIONS RANGE detected up to 6 meters deep from the ground level:

- Hydrocarbons C <12 400 mg/kg - 6500mg/kg
- Hydrocarbons C > 12 1300 mg/kg - 4600mg/kg
- Benzene 3 mg/kg - 118 mg/kg
- Ethylbenzene 100 mg/kg
- Total Xylenes 80 mg/kg - 400 mg/kg

RANGE OF CONCENTRATIONS CONTAMINATION OF GROUND WATER:

- TOTAL hydrocarbons 600 µg/l - 12000 µg/l
- Benzene 130 µg/l - 900 µg/l
- Toluene 17 µg/l - 2850 µg/l
- Ethylbenzene 100 µg/l - 330 µg/l
- Total xylenes 12 µg/l - 825 µg/l
- MTBE 50 µg/l - 6000 µg/l

2.4 Regulatory framework

D.Lgs. 152/2006



3. Pilot-scale application in field

3.1 Extraction system

Installation of an extraction well and a monitoring well both located within the contaminated area.

Execution of the test, with a portable system assembled for ventilation tests, consisting in:

- a Blower (aspirator) with flameproof execution side channels, being hydrocarbons, with a power of 3 KW, 50 Hz;
- a 200 L activated carbon filter for air;
- Mineral-based activated carbon for air drawn into cylinders with a high degree of activation of the type Chemviron Carbon 207E 4x8 US mesh.
- step test at different air extraction rates, for each of which the monitoring induced depression on wells, concentrations of VOC, CO₂ and O₂, both through the wells monitoring, which exits the system.

The pilot test was conducted by inducing two different, corresponding depressions steps respectively at two different values of extracted air flow rates: the test began with a flow rate Q1 = 450 m³/h and subsequently continued with a flow rate Q2 = 350 m³/h.

3.3 Radius of influence

In order to calculate the radius of influence, the distance at which the vacuum is 10% of the vacuum applied to the extraction well is considered.

3.4 Off gas Treatment

a 200 L activated carbon filter for air: mineral-based activated carbon for air drawn into small cylinders with a high degree of activation of the Chemviron Carbon 207E 4x8 US mesh type.



3.5 Control parameters

A step test was carried out at different air extraction rates, for each of which the depression induced on the monitoring wells, the concentrations of VOC, CO₂ and O₂, both through the monitoring wells, and at the outlet were evaluated. from the system.

The maximum concentration of polluting vapours extracted occurred in the first 30 minutes of the test, beyond which there was a drastic lowering of the same, up to values close to those of the natural subsoil.

With the decrease in extracted flow, a very modest increase in vapours in terms of VOC was observed, certainly not very significant.

The test was interrupted after about 8 hours due to the temporary exhaustion of the polluting load.

A good response of the system was instead obtained from the variation of the oxygen and carbon dioxide levels, which caused a decrease in O₂ and an increase in CO₂. This data indicates a modest but continuous presence and action of indigenous microorganisms, which oxidize organic substances by consuming oxygen and producing water and carbon dioxide.

From the calculations carried out it was possible to evaluate the optimal operating flow rate equal to approximately $Q = 400 \text{ m}^3/\text{h}$, with a radius of influence for each ventilation shaft equal to approximately 12 m.



4. Full-scale application

4.1 Extraction system

The air extraction system (EVS) has provided for n. 3 ventilation shafts of 2 "pushed up to a depth of 3 m, and made up as described below:

- Blower (aspirator) with explosion-proof side channels (being hydrocarbons) with a power of 5.5 KW.
- "water trap" (for condensation of the extracted vapours);
- 200 litres active carbon filter for air;
- n. 3 gate valves to regulate flows and capacities;
- vacuum gauges with scales from 0 to 100 mbar and from 0 to 1000 mbar;
- PVC pipes with high decompression resistance;
- wellhead that can be inspected, with quick couplings, for measuring the gases and depressions induced on each ventilation shaft;
- connection to the blower of the wells with pipes of adequate diameter;
- all the pipes have been conveyed into a regulation barrel with valves for regulating the flows
- dilution valve before entering the blower.

4.3 Radius of influence

In order to calculate the radius of influence, the distance at which the vacuum is 10% of the vacuum applied to the extraction well is considered.



4.4 Off gas Treatment

The vapour treatment system (VOC) includes n. 1 filter containing activated carbon for air based on mineral drawn in cylinders with high degree of activation of the Chemviron Carbon 207E 4x8 US mesh type.

Below is a description with the characteristics of the activated carbon:

- Activation process = Steam;
- Density = 0.46 g/cc;
- Compacted material density = 0.50 g/cc;
- Packaging humidity = 3% by weight;
- Total specific surface (BET method) = 1100 m²/g;
- Ash content = 8% by weight;
- Hardness = 97%;
- Iodine index = 1000 mg/g;
- Carbon tetrachloride index = 60% by weight;
- Benzene index = 35% by weight;

the average concentration of volatile organic substances to be removed is about 1g/m³; the plant has a capacity of 400 m³/h, the total amount of volatile organic substances to be removed is about 400 g/h per hour. Every 100 kg of carbon have an adsorbing power of about 10 kg of organic substance. The abatement system, therefore, consisting of a 600 kg battery of activated carbon, has an autonomy of about 2 months.

4.5 Control parameters

<i>Control</i>	<i>Frequency</i>	<i>Parameters</i>	<i>Point of monitoring</i>
<i>Startup (7-10 days)</i>	<i>daily</i>	<i>Flow</i> <i>Extraction pressure</i> <i>Steam concentration</i>	<i>Extraction well</i> <i>Pipeing</i> <i>Emission</i>
<i>After startup</i>	<i>Every 2 weeks</i>	<i>Flow</i> <i>Extraction pressure</i> <i>Steam concentration</i>	<i>Extraction well</i> <i>Pipeing</i> <i>Emission</i>



6. Post treatment and/or Long Term Monitoring

6.1 Post treatment and/or Long Term Monitoring

In order to verify the dynamics of the remediation process and the proper functioning of the installed system, monitoring/maintenance visits are scheduled on a monthly basis, including the following works:

- General maintenance of plants and calibration of installed systems;
- Replacement and disposal, when necessary, of spent activated carbon;
- Measurement of VOC, CO₂ and O₂ leaving the ventilation system and regulation of induced depressions;
- Sampling of the incoming and outgoing air from the abatement system. Organic substances are analyzed on a quarterly basis for the entire duration of the remediation. The data is developed and processed using specialized software.

Monitoring of the soil gas, after a three-month stop of the EVS, to implement a new risk analysis three years after the start of treatment.

volatile organic substances analyzed: Benzene - Toluene - Ethylbenzene - Xylenes (BTEX), MTBE and total hydrocarbons.

Samples are taken by means of a low flow pump and adsorption on activated carbon vials

7. Additional information

7.1 Lesson learnt

In case of contamination even of the saturated one, a technology that is effective for both matrices (unsaturated and saturated) is preferable

1. Contact details - CASE STUDY: SVE n.12

1.1 Name and Surname	Daniela Fiaccavento
1.2 Country/Jurisdiction	ITALY-VENETO
1.3 Organisation	ARPAV
1.4 Position	Public servant, expertise in soil remediation
1.5 Duties	Evaluation site characterization and remediation projects
1.6 Email address	daniela.fiaccavento@arpa.veneto.it
1.7 Phone number	+39 0422 558504

2. Site background

2.1 History of the site

In July 2011, due to a road accident between a little van and a petrol tanker, 8 m³ of unleaded gasoline spilled onto the road, affecting neighbouring land and some stretches of moats adjacent to the road

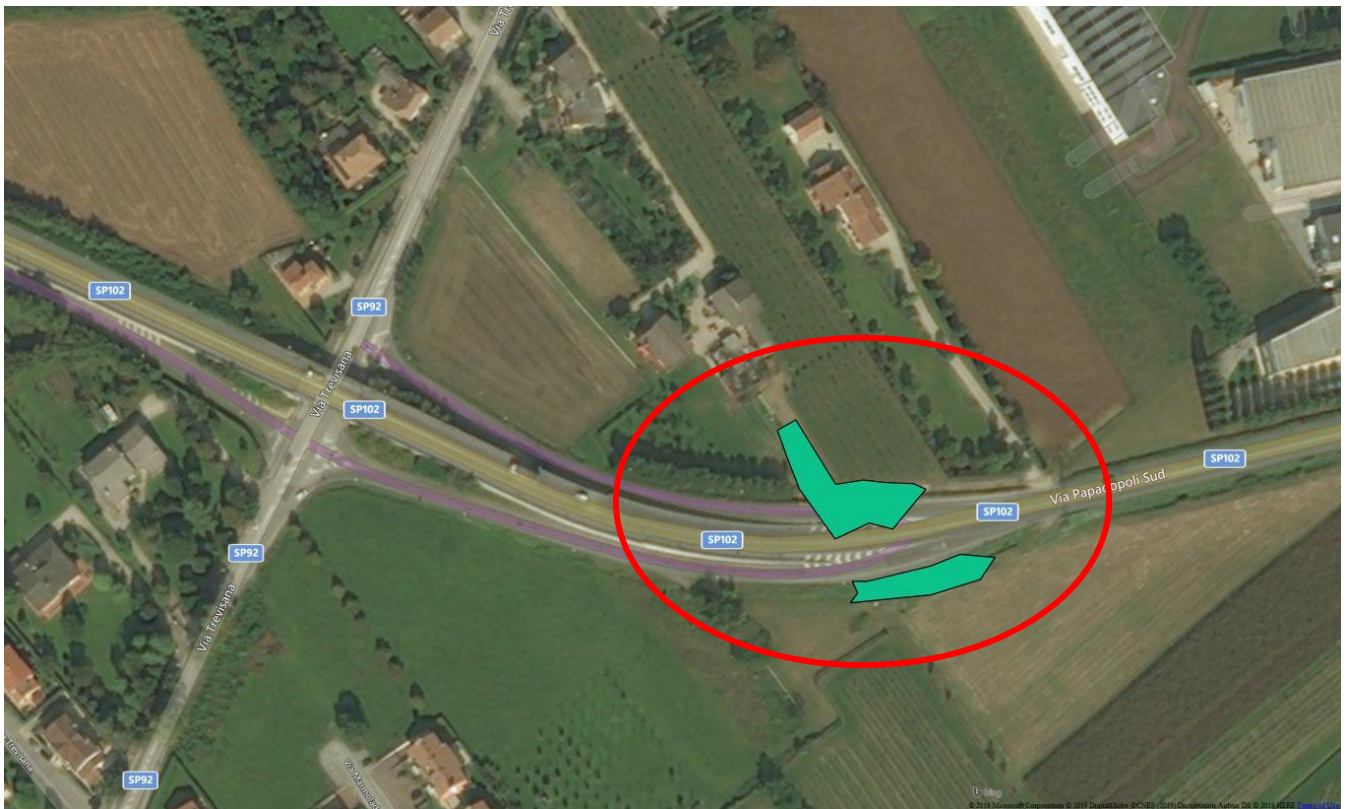

After the development of the site-specific risk analysis, the contaminated area to be remediated was that shown in the figure below. The area of contaminated soil was around 1000 square meters, 700 in the field and 300 under the road. The subsoil was contaminated up to four meters depth, only in one survey up to 5 meters.

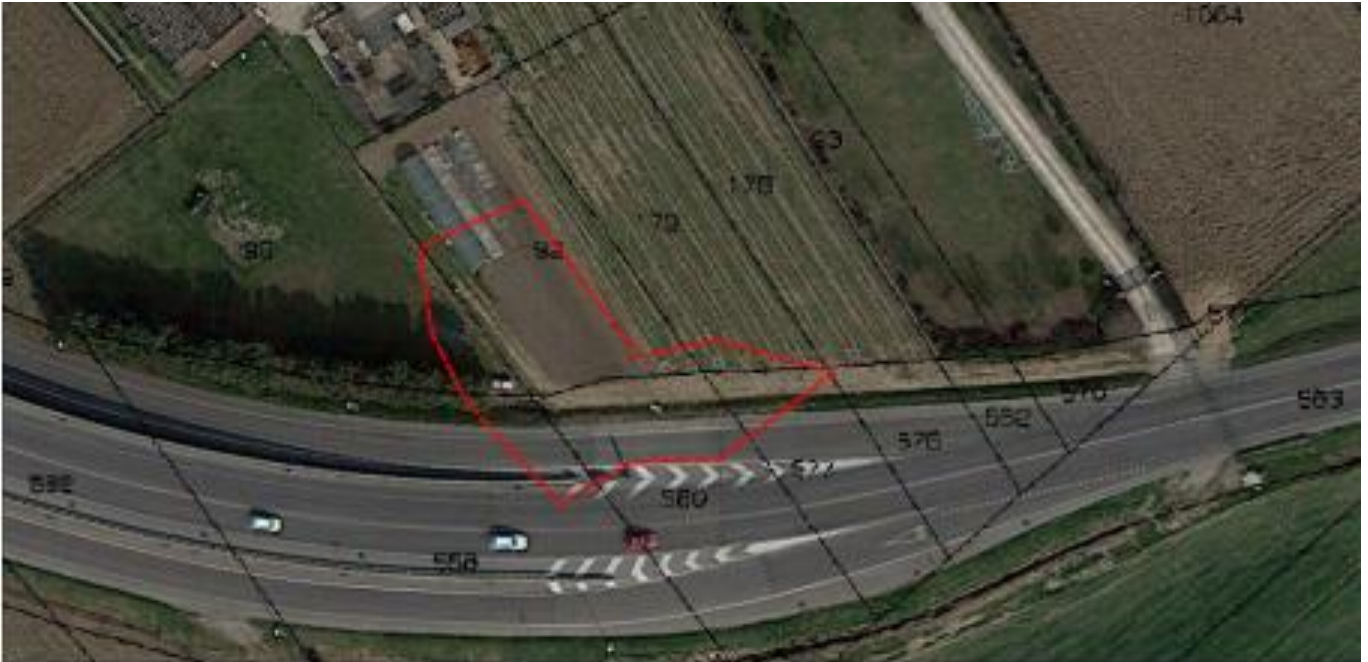

2.2 Geological setting

Under the first 20 centimeters of topsoil, the site presents 2/3 meters of alternation of sandy silts and silty sand and then, till 8 meters depth, fine and medium gravels in a sandy matrix.

The depth to ground water is approximately 2.5/3.0 meters below ground surface.

Below is reported the Shepard Diagram in which is collocated the types of soil of three surveys at different depth.

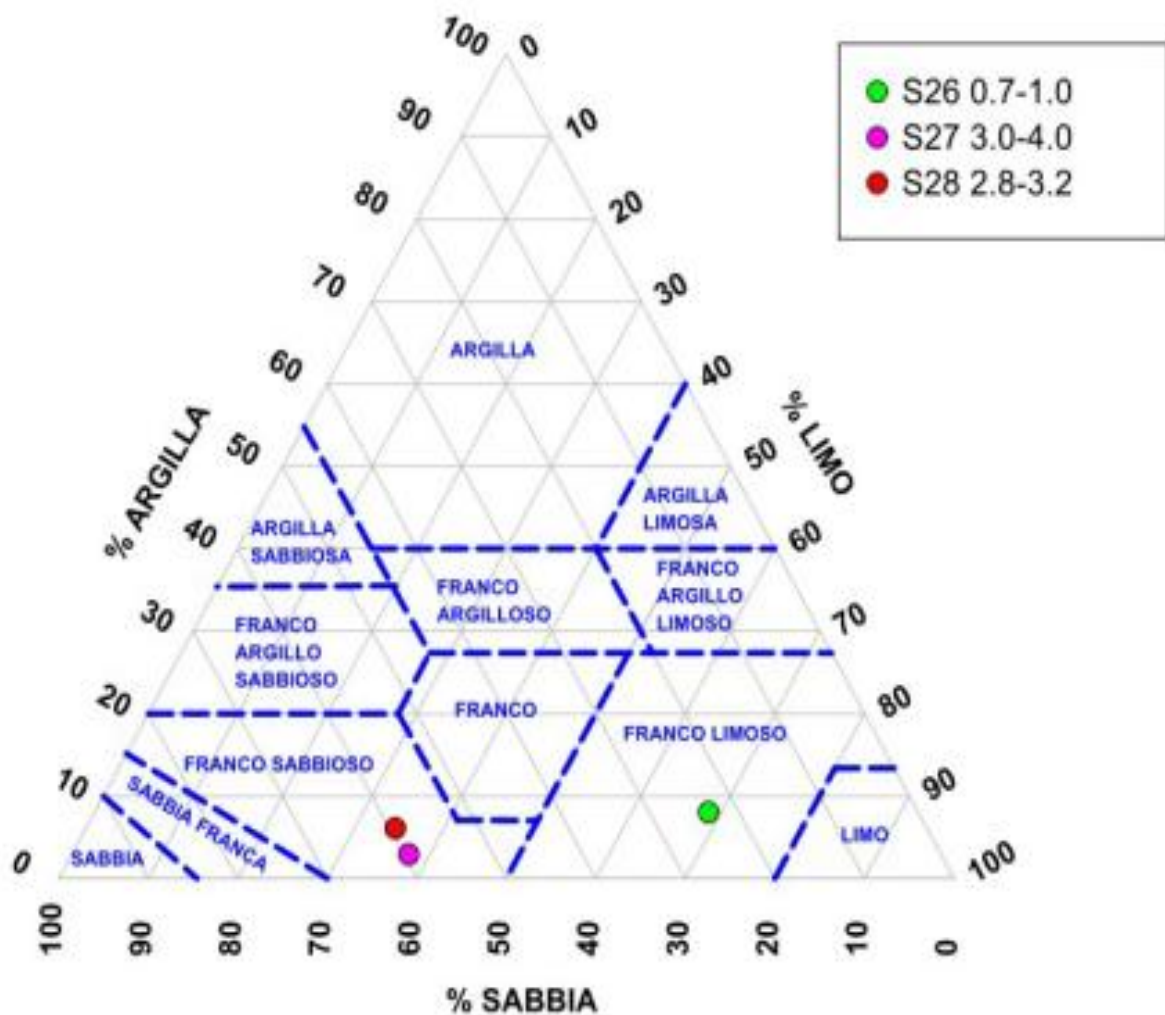

Shepard Diagram

In the figure below is reported a stratigraphy of a soil survey.

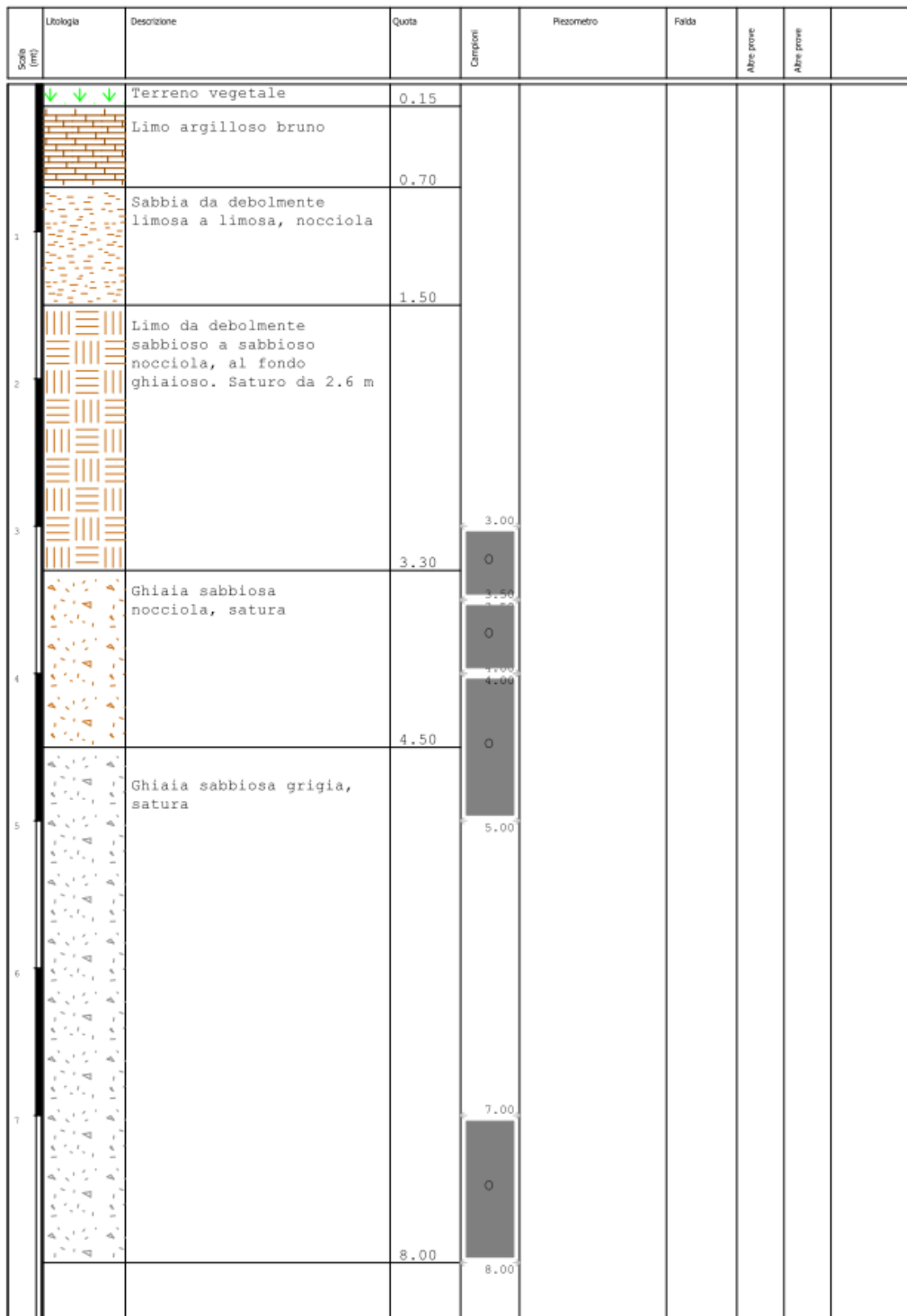

2.3 Contaminants of concern

Organic Compounds typical of unleaded petrol: benzene, ethylbenzene, toluene, xylene, styrene, MtBE (methylterbutyl ether), also measured in soil gas sampling from well realized in to the subsoil.

In Italy is defined as contaminant also light hydrocarbons (C<12) and heavy Hydrocarbons (C>12), which is specified according to MADEP Method (Aliphatics C5-C8, Aliphatics C9-C12, Aromatics C9-C10 and Aromatics C11-C12 for light Hydrocarbons and Alifatics C13-C18, Alifatics C19-C36 and Aromatics C13-C22 for heavy Hydrocarbons).

In the two tables below are reported The maximum concentration, in mg/kg, for each contaminants of concern, in the surface soil (0÷1 meter deep) and in the subsoil (under 1 meter deep).

Table 1. Max Concentration in surface soil for each CoC

Benzene	Etilbenzene	Stirene	Toluene	Xileni	MTBE	C<12	C>12	CTOT C<>12	ALIFATICI C5-C8	ALIFATICI C9-C18	ALIFATICI C19-C36	AROMATICI C9-C10	AROMATICI C11-C22
8,1	71,0	2,3	169,0	590,0	28,0	3150,0	422,0	3180,3	1619,1	105,5	145,7	1087,7	0,0

Table 2. Max Concentration in subsoil for each CoC

Benzene	Etilbenzene	Stirene	Toluene	Xileni	MTBE	C<12	C>12	CTOT C<>12	ALIFATICI C5-C8	ALIFATICI C9-C18	ALIFATICI C19-C36	AROMATICI C9-C10	AROMATICI C11-C22
14,5	44,1	-	352	519	31,9	4980	37,6	5010,6	3921,4	17,5	29,8	1041,6	0,20



2.4 Regulatory framework

The Italian law provides for remediation of contaminated sites specific targets for urban soil and subsoil, for each contaminants of concern (CSC col. A tab. 1 All. 5 Parte Quarta Titolo V del D. Lgs. n. 152/06).

With the application of a site based risk analysis, whose results have been reported by the company in the specific document approved by the responsible Institution, it has been defined new target levels for soil.

It has been defined target concentrations for each contaminants also in soil gas, to evaluate the performance of the Soil Vapor Extraction plant.

3. Pilot-scale application in field

It wasn't realized a pilot scale application before the full scale plant.

Pilot test were realized after the installation of the full scale plant, before its full operation.

4. Full-scale application

4.1 Extraction system

Because of the fact that the ground water was positioned from 2.5 to 3.5 meters of depth, the project of SVE was based on a system of horizontal wells, like in the two figures above.

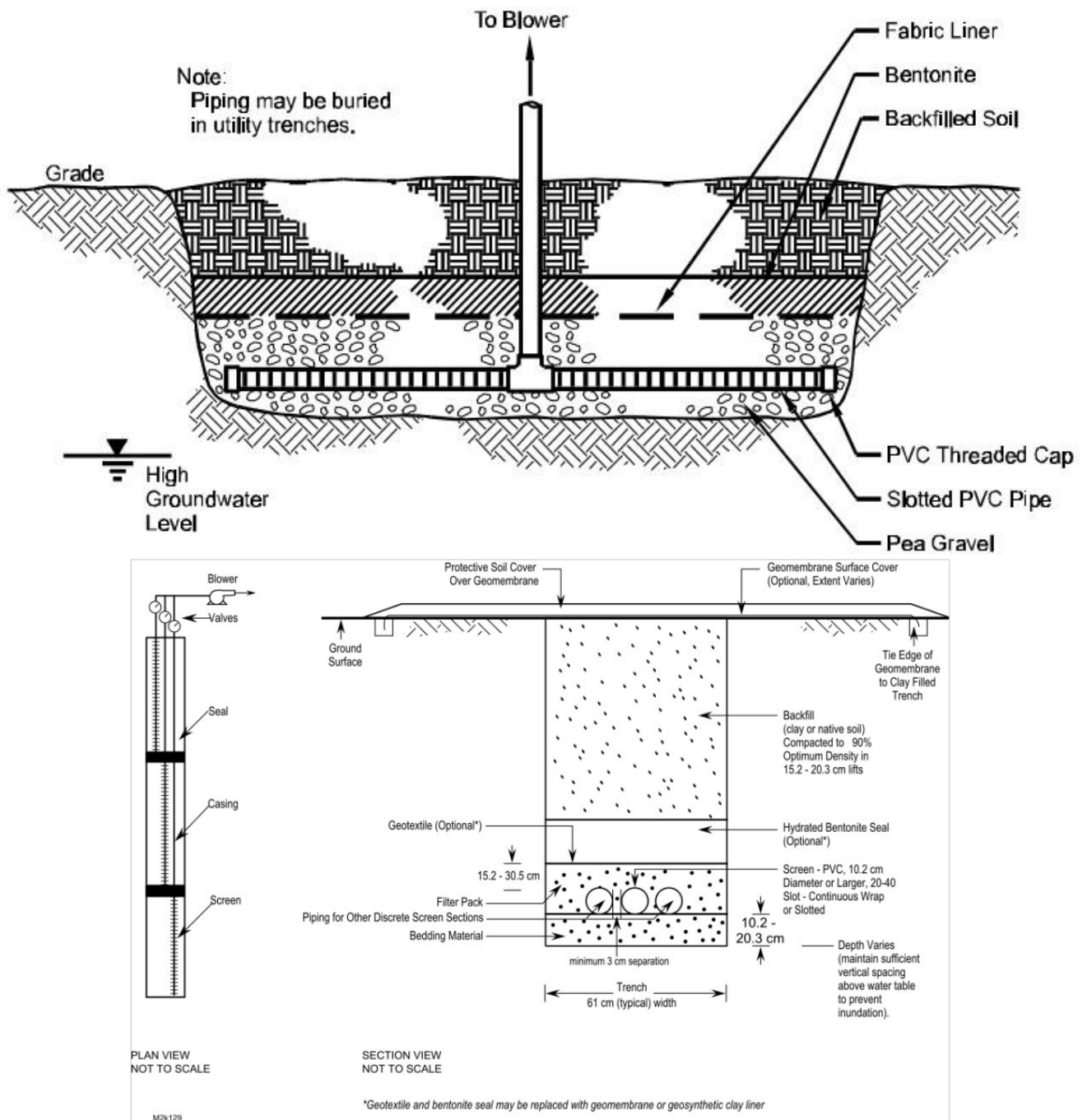

Typical construction scheme of an horizontal extraction well, view in plan and in section

(from U.S. Army Corps of Engineers, 2002)

Two horizontal lines were been made, one parallel to the road (line 1), the other orthogonal the road, forward the house (line 2), as shown in the next figure.

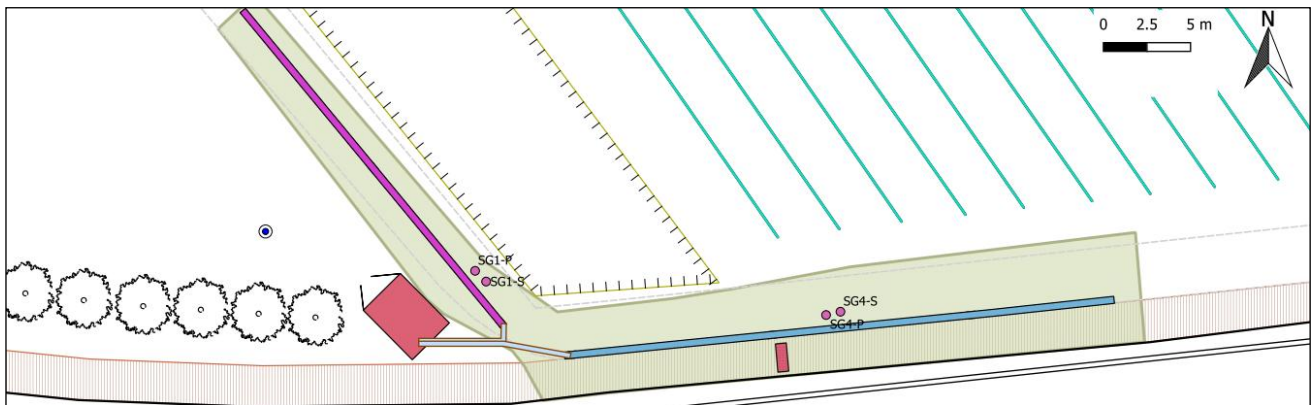

In the following table are reported the technical characteristics of the two lines of SVE

	Line 1			Line 2	
width	0.4m			0.4m	
depth	1.1m			1.3m	
length	38m			26m	
Number of sections/extraction wells	3			2	
Denomination of wells	SVE L1A	SVE L1B	SVE L1C	SVE L2A	SVE L2B
Blind section	1m	12m	24m	1m	12m
Screened section	12m	12m	12m	12m	12m

In the figure below is reported the plant scheme, which represents both extraction lines and the off-gas treatment system.

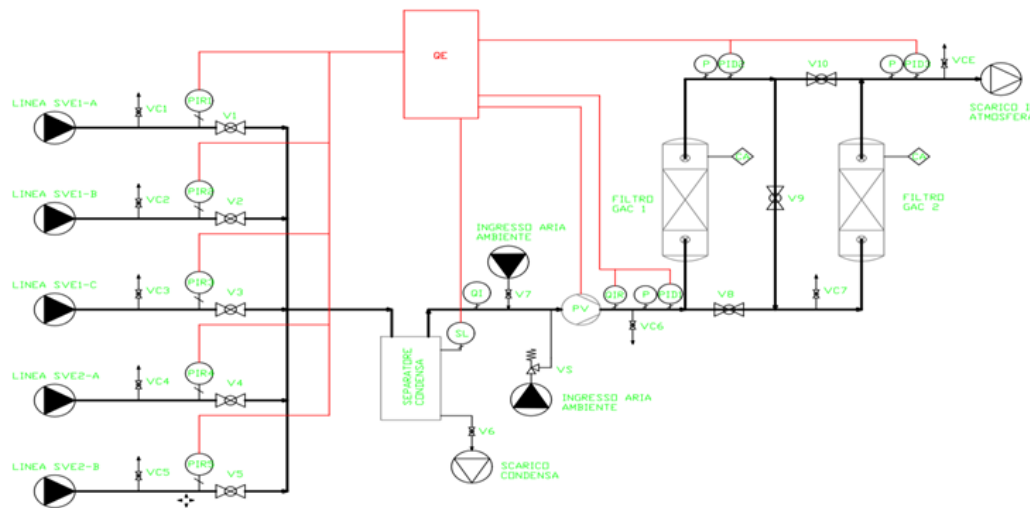

SIMBOLI	DESCRIZIONE
QE	QUADRO ELETTRICO DI ALIMENTAZIONE CONTROLLO E CAMPIONAMENTO VOC ALIMENTATO DA LINEA ELETTRICA ESTERNA.
FILTRO GAC1 E 2	COLONNA A RIEMPIMENTO CON CARBONE ATTIVO GRANULARE PER ARIA
PV	POMPA A VUOTO O ASPIRATORE
VCI - 7	RUBINETTO CAMPIONAMENTO GAS
VCE	RUBINETTO CAMPIONAMENTO EMISSIONI IN ATMOSFERA
V1 - 10	VALVOLE DI INTERCETTAZIONE
VS	VALVOIA DI SICUREZZA
PIR1-5	MANOMETRO INDICATORE E REGISTRATORE CHE INVIA IL SEGNALE ELETTRICO AL QUADRO QE
P	MANOMETRI INDICATORI
SL	SENSORE DI LIVELLO ACQUA NEL SEPARATORE DI CONDENSA CHE INVIA IL SEGNALE ELETTRICO AL QUADRO QE
QI	FLUSSIMETRI INDICATORE
QIR	FLUSSOSTATO INDICATORE E REGISTRATORE CHE INVIA IL SEGNALE ELETTRICO AL QUADRO QE
PID1 - 2	PUNTI DI PRELIEVO GAS PER SENSORE PID POSIZIONATO NEL QUADRO QE
CA	PUNTO DI CARICO CARBONI ATTIVI

Once extracted, the contaminated vapor was dealt to a treatment unit, based on activated carbon adsorption (see the section “off-gas treatment”)

After the beginning test (explained in the following section) SVE system started in January 2018 and was stopped before soil testing, performed in March 2019, even if the target in soil gas concentrations had already been reached in September 2018.

4.3 Radius of influence

The radius of influence were verified directly during the functioning of the plant through the measurement of the depression induced at the edge of the site.

The field test was realized in the following way:

1. installation of high sensitivity differential pressure sensors (± 300 Pa) in three monitoring wells (located like in the following figure) and reset of the instrument (zero adjusted - 0 Pascal);
2. recording of basic value;
3. pump start with all 5 extraction lines open;
4. continuous recording of flow rate and depression values

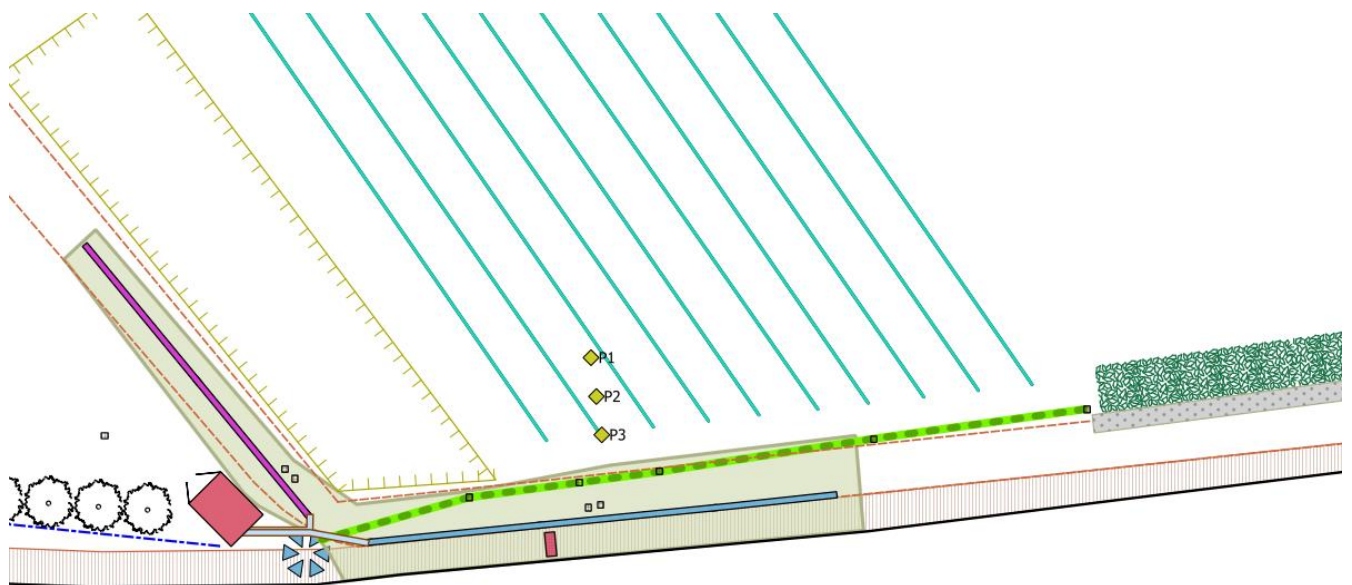

Location of pilot test wells

It was measured an appreciable induced depression, with a calculated radius of influence (6.5 m and 8.4 m) that in both cases exceeded the intervention distance, equal to 3-4 m, from the axis of extraction lines.



4.4 Off gas Treatment

The vapor treatment unit consists of an activated carbon unit of two modules with a capacity of 250 kg each arranged in series. The details of each module are shown below.

length plates	1.6 m
area plates	1.2 square meter
Air flow	100 mc/h
Air velocity in the filter	1.4 m/s
Contact time	1.2 s

The activated carbon will be of mineral origin, physically activated with steam. Such materials are suitable for air flows with concentrations of about 2000 ppm and have an adsorption yield of about 10%.

Yield of carbon absorption	10%
Amount of coals needed	25,600 kg
Carbon consumption rate	5.5 kg/h
Carbon filter (2+250kg)	500kg
Filter charge duration	3.8 days

In the case in point, the project data to evaluate the duration of the filters is summed below.

Media soil gas concentration	2,500 mg/mc
Extraction flow	100 mc/h
Contaminant flow	0.25 kg/h
Total amount of contaminant to be removed	1,048 kg
Filter charge duration	80 days

To achieve the target of remediation, it has been used around 2,000 kg of activated carbon.

4.5 Control parameters

In order to continuously monitor emissions within the legal limits provided, it has been installed a continuous control system for the measurement of VOC at the effluent discharge through a PID.

To assess the progress of the remediation, soil vapour samples were collected from four soil gas wells, located near the soil vapour extraction line; the wells were realized in couple, two surface wells (up 1 meter deep) and two wells to monitoring soil gas in the subsoil (up to 2.5 meters deep)

The following figure shows the concentrations in the wells before starting of SVE and after some months of its functioning. The concentrations are also referred to the target concentrations defined through risk based analysis (“CSR” in the figure).

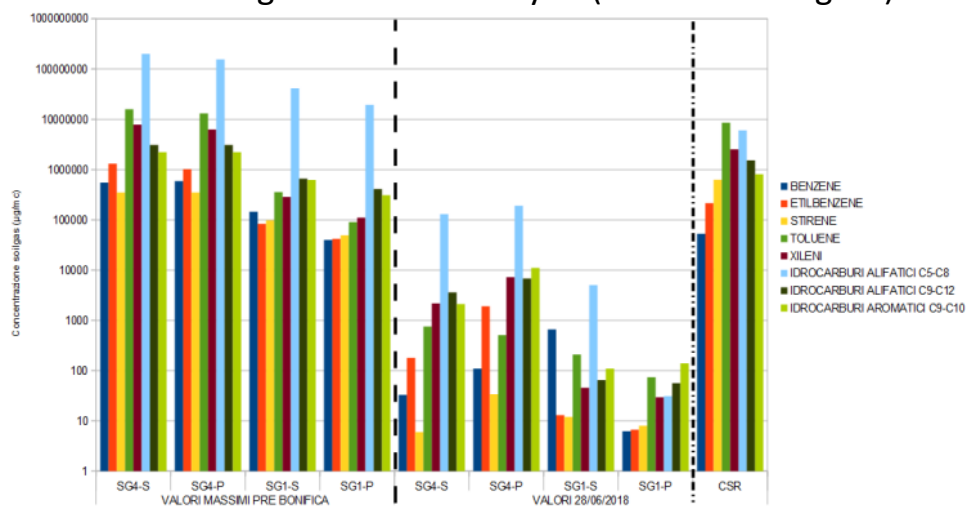

To collect soil gas sample were used stell canister or glasses bottle-vacuum (0.5 or 1 liter) with flow reduction to 50 ml/min. The soil gas chemical analysis were leaded with the MassDEP-APH 2009 method.





6. Post treatment and/or Long Term Monitoring

6.1 Post treatment and/or Long Term Monitoring

In 2018 we led two campaigns of monitoring soil gases from wells, in both cases after turning off the plant to evaluate a possible rebound effect.

Once the achievement of the soil gas target concentration had been verified, test activities on the soils were carried out, realizing four soil probes 5 meters deep. In each sample (five for each probe) it has been verified the achievement of the legal limits for each contaminant of concern.

After this test two other soil gas investigation campaigns were carried out, to confirm that the soil gas targets (concentration limits) have been reached.

7. Additional information

7.1 Lesson learnt

The case study described in this work was the first case in which it has been used a SVE extraction in fine soil (like sandy loam) and with a groundwater near the surface.

So, we found ourselves evaluating another plant solution, compared to other cases, with horizontal wells instead of the “classic” vertical wells.

In addition, unlike what the current legislation provided, reference soil gas concentrations were defined through risk analysis with the aim of assessing the progress of the remediation system.

7.3 Training need

I think that it would be very important to create and maintain a continuous training, not only with webinars and workshops, but also with creation of technical guidelines, and almost with training on-the job and sharing experiences with technicians from other organizations.

7.4 Additional remarks

In this paragraph I describe the experimentation performed in June 2017 to monitor the trend of concentration of contaminants in soil gas. This experimentation wasn't directly connected with the functioning of SVE, but it was carried out to collect more informations about the behaviour of soil gas during a certain observation period.

Going into specifics, the purpose of the experiments was:

- Evaluation of the comparability of different measurement methods
- Evaluation of the temporal variations on a sub-hourly scale of the Cov concentrations in the aeriform matrices
- Evaluation of the relationships and possible differences between surface probe and deep probe
- Possible indications of the possible perturbations induced by the sampling to the state of motion soil gas.

At the first, a high sampling frequency PID was installed in the deep probe, while the pressure differential trend was monitored in the surface probe.

A second Pid, identical to the first, was also installed for the measurement of volatile compounds in a free atmosphere. During this period, two campaign of soil gas samples were carried out, both with vacuum bottle and with dynamic flux chamber (in the figure below).



In the same period it has been installed a micrometeo control unit composed by a:

triaxial ultrasonic anemometer;

- rain gauge;
- thermohygrometer;
- differential pressure sensors

Continuous field measurements and laboratory analyzes of soil gases showed daily variability in concentrations; in addition, if the measurements are made at times favourable to the accumulation of contaminant, the detected concentrations will be higher than at other times of the day.

More details and explanation can be found at the following link

https://www.arpae.it/dettaglio_documento.asp?id=7277&idlivello=1171

These experiments were carried out thanks to Copernico srl (UD), www.copernicon.it the consulting company in the field of remediation of contaminated sites that followed the remediation activities from characterization to testing. The images, graphics and tables shown in the present questionnaire are taken from the project documents drafted by Copernico.



1. Contact details - CASE STUDY: SVE n.13

1.1 Name and Surname	Aldo Trezzi
1.2 Country/Jurisdiction	Italy
1.3 Organisation	Ramboll Italy S.r.l.
1.4 Position	Principal
1.5 Duties	Aldo has more than 25 years of experience in the management of projects related to water treatment, soil and groundwater characterization and remediation of complex sites
1.6 Email address	atrezzi@ramboll.com
1.7 Phone number	+39-335 423725



2. Site background

2.1 History of the site

Large Industrial Chemical site (more than 100 ha) active since 1901.

Actual main production: Fluorinated Compounds

Historical productions involved large use of CrVI and CHCs, mainly Chloromethanes.

The area of interest for the application of the SVE system is about 7,000 m² and is impacted by mainly Chloromethanes both in the vadose zone and in the saturated zone.

2.2 Geological setting

From 0 to 1-2 m bgl typically is present filling material.

From 1-2 m bgl to 18-20 m bgl the soil consists mainly of gravel with sand and silt.

The depth to ground water is approximately 9 m bgl.

The following images show the geological setting from 0 to 10 m bgl.





2.3 Contaminants of concern

The main compounds of concern are:

- Tetrachloromethane
- Trichloromethane
- Trichlorofluoromethane

Max concentration detected in unsaturated soil:

- Trichloromethane: 23.00 mg/kg

Regarding the unsaturated soil, the only VOC detected in the area was the Trichloromethane, with a concentration of 8.9 mg/kg in the first meter b.g.l., 6.7 mg/kg between 2 and 3 meter b.g.l. and 23 mg/kg between 4.5 and 5.5 meter b.g.l.. Italian law threshold concentration value (CSC) for Trichloromethane is 5 mg/kg, and also the risk concentration value (CSR) defined by the risk analysis for Trichloromethane is 5 mg/kg.

Max concentration detected in the groundwater (2009-2012):

- Tetrachloromethane : 170,000 µg/l
- Trichloromethane: 290,000 µg/l
- Trichlorofluoromethane: 10,000 µg/l

2.4 Regulatory framework

Clean-up goals for soil and groundwater were defined in the Risk Assessment, and are included in the on-going remedial plan, approved in 2012. According to Italian regulation, although the remedial targets are defined on a Risk Assessment basis inside the facility (SSTLs or CSR), groundwater quality at the end of remedial action must comply with regulatory limits (CSC, much more conservative than calculated SSTLs) at the downgradient boundary of the site. Therefore, once reduced the concentration below the CSR for inhalation risk inside the facility, the ultimate clean-up goal for groundwater is to reduce and control the off-site migration.

Nonetheless, scope of the SVE system is to remediate the unsaturated soil: reduce as much as technically possible the presence of VOCs in the soil gas and obtain concentration of the VOC compounds in the soil below the calculated risk concentrations (< CSR).

Other technologies have been applied to remediate the saturated zone.

3. Pilot-scale application in field

3.1 Extraction system

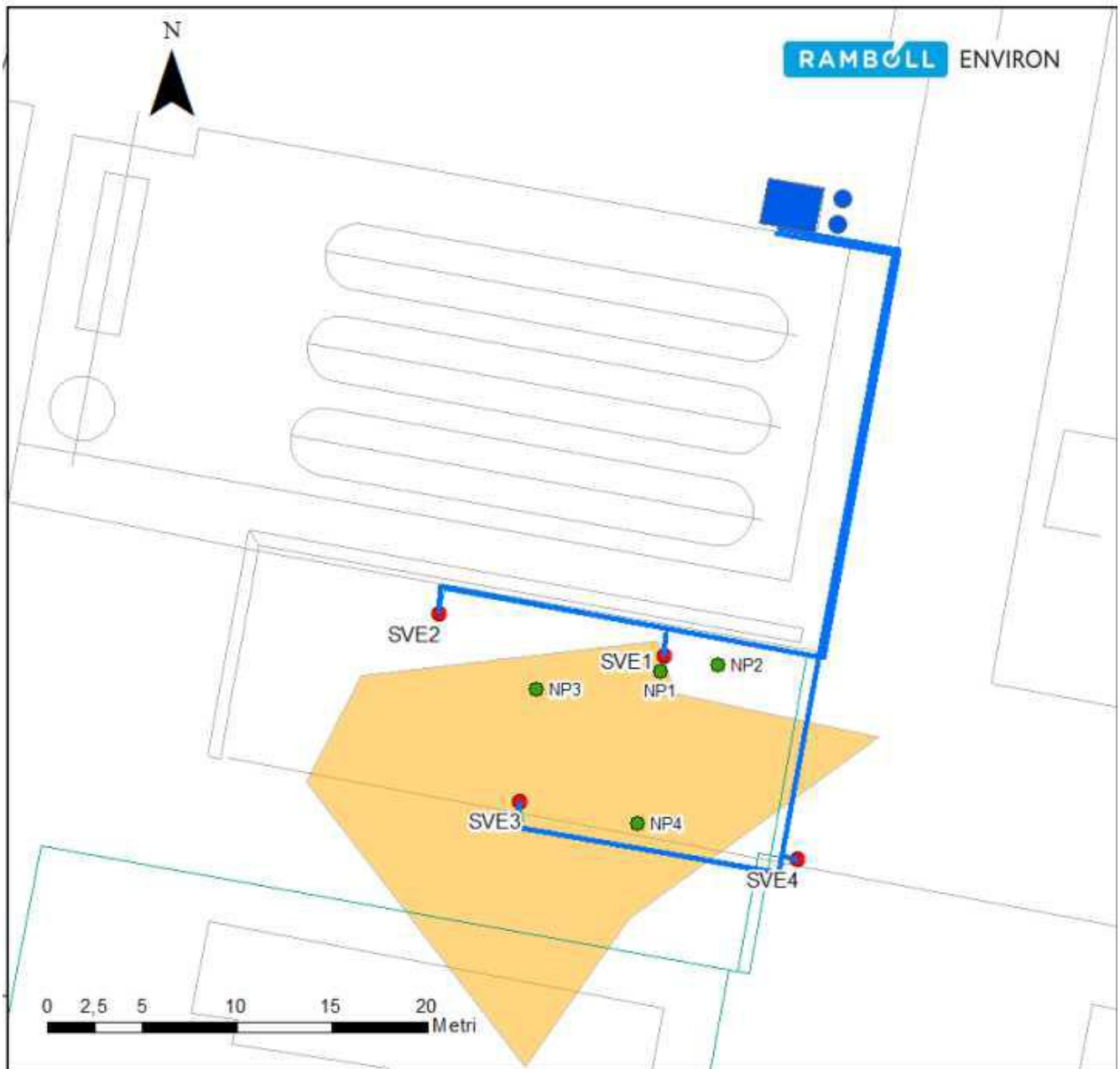

Before the installation of the full scale system, a pilot scale application was performed to estimate the effective Radius of Influence (ROI) of each extraction well, operating Flow Rate & Vacuum per each extraction point. The test system consisted in #4 SVE points (screened from 1 to 9 m bgl), # 4 Nests Probe Points (each equipped with #4 NP located

at different depths), #1 vapour/water separator tank, #2 air blowers connected in parallel (Each blower: 350 mc/h @ ΔP 150÷175 mbar); #2 granular activated carbon filters connected in series (1,300 litres each) in order to remove the VOC from the vapour stream before the emission in atmosphere.

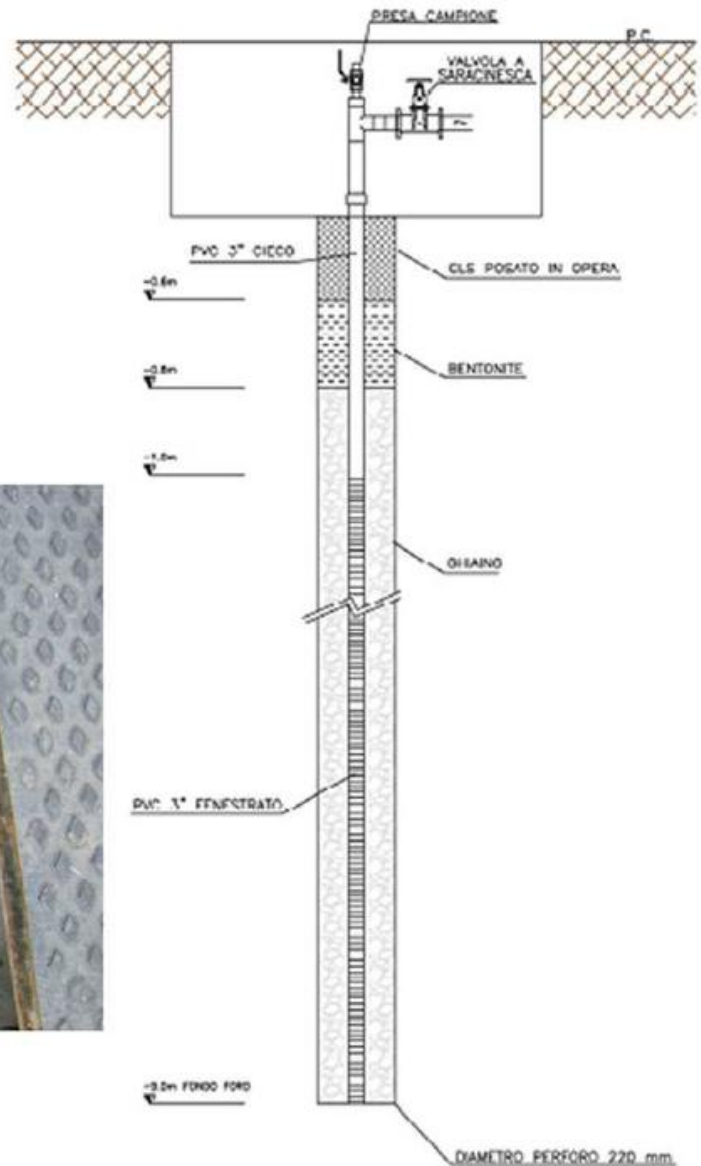

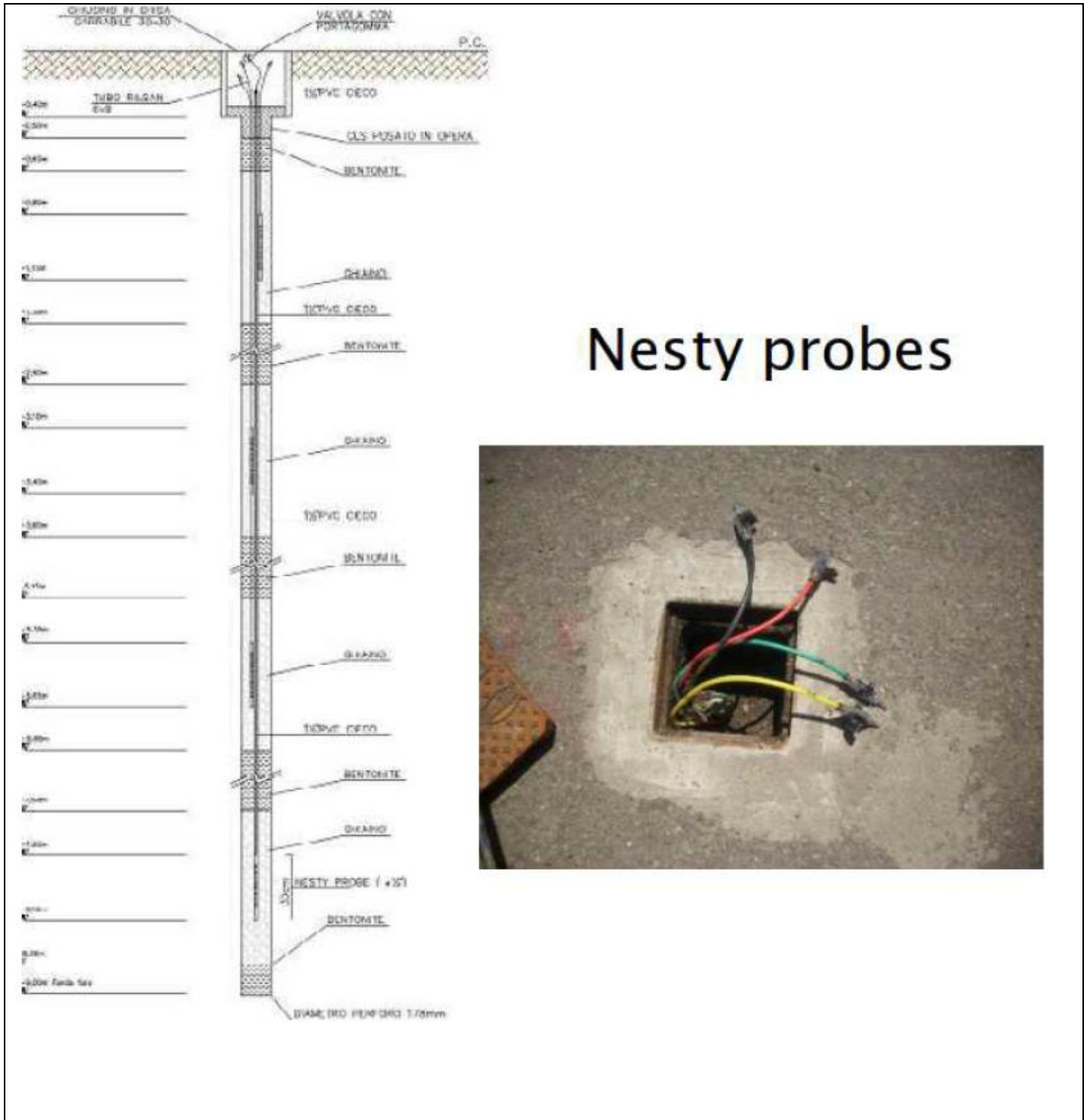

Nesty probes



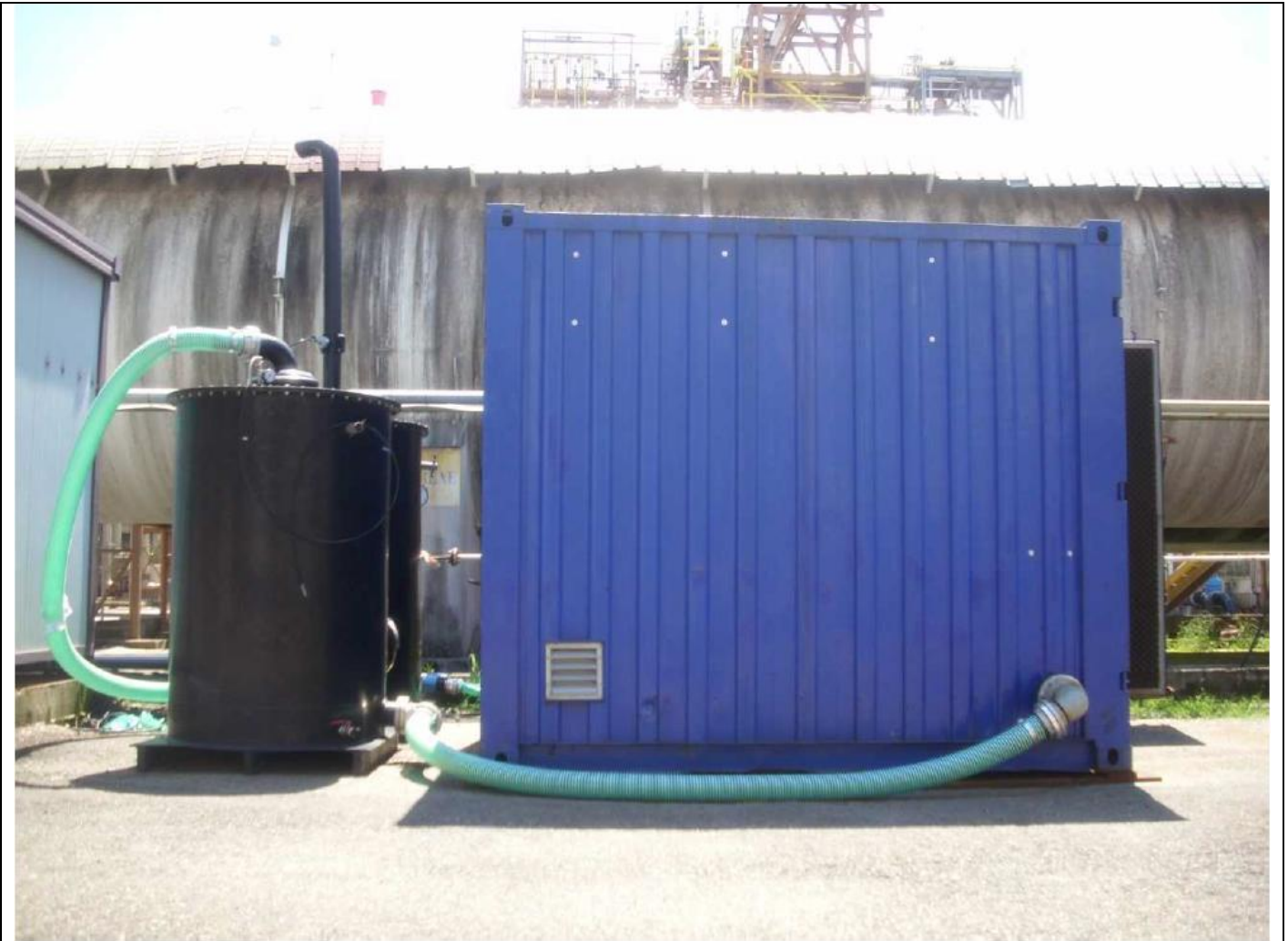

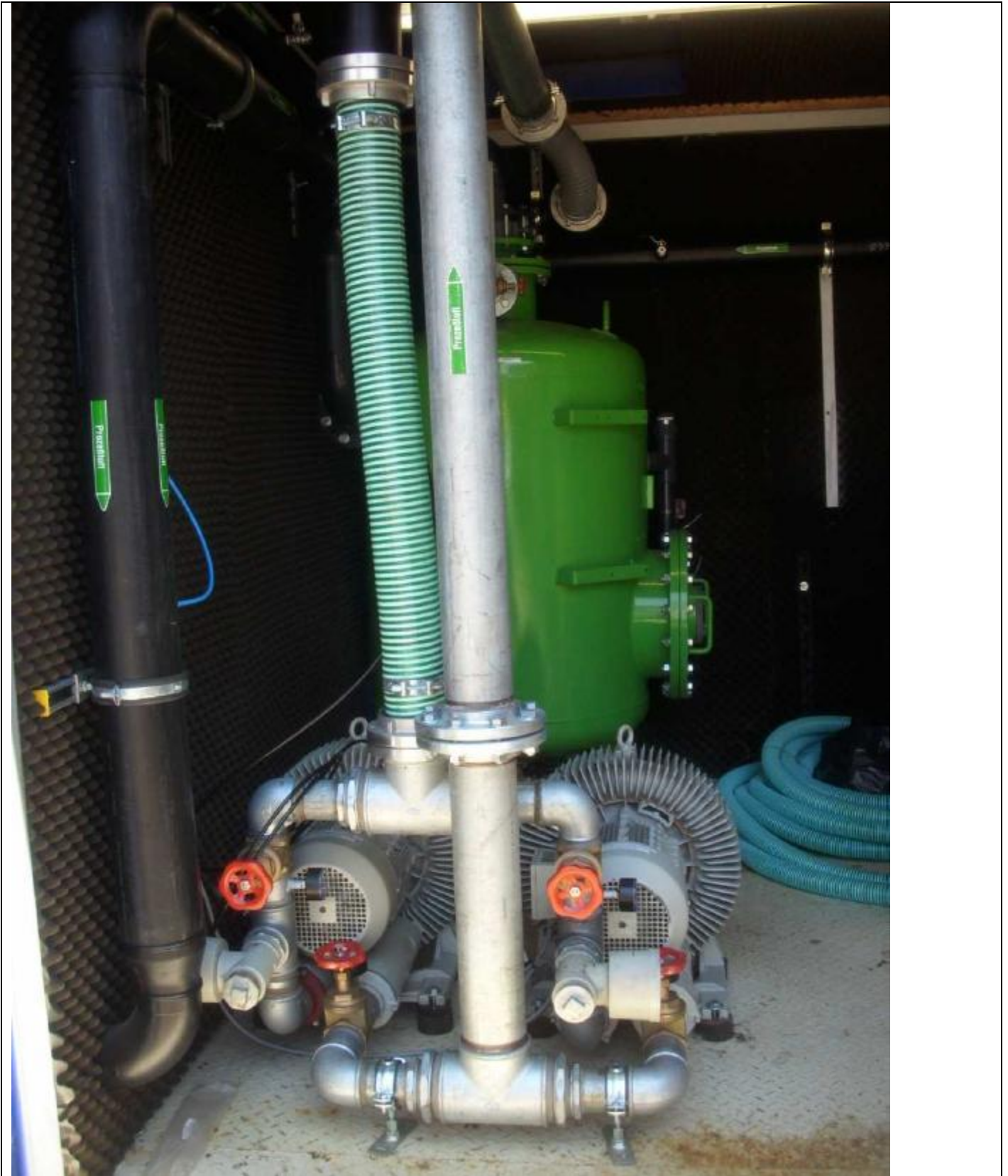

3.3 Radius of influence

Tests performed:

- n. 2 step vacuum test
- n. 5 long-term tests at constant vacuum

Results:

- ROI = 9 ÷ 10 m (cutoff -2.5 Pa)
- Flow rate each SVE ~ 130 mc/h
- Vacuum @ SVE head: ~ - 30 mbar

Moreover:

- n. 4 SVE points showed a good overlap of influence areas covered by each point
- granular activated carbon filters showed good removal of contaminants present in the extracted vapours

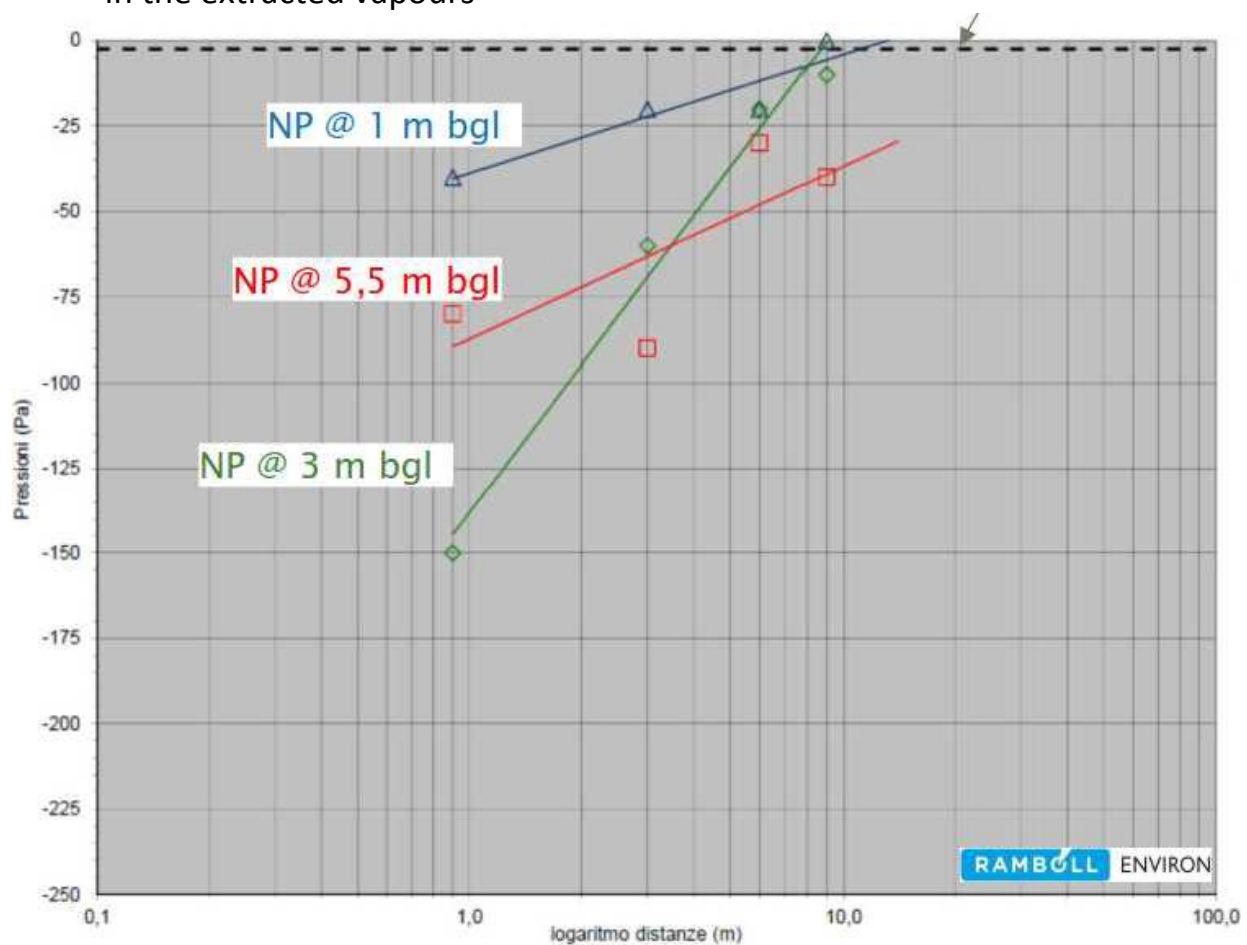



3.4 Off gas Treatment

During the pilot test the extracted vapours were treated by # 2 granular activated carbon filters connected in series (1,000 litres each).

3.5 Control parameters

To assess the effectiveness of the treatment and evaluate the ROI, the following parameters were monitored during the pilot scale application:

- ΔP in/out blower;
- Vacuum at the wellhead of the suction point/points;
- Vacuum induced at the soil gas monitoring points (Nesty Probes) at different distances and depths from the extraction well/wells;
- Flow rate of extracted gases;
- VOC concentrations before and after treatment;
- O_2 , CH_4 , CO_2 monitoring at each SVE extraction and NP monitoring point before VOC sampling.

4. Full-scale application

4.1 Extraction system

The Full Scale SVE has been designed considering the Pilot Test results (ROI, flow rate per each extraction point, vacuum to be applied at each extraction point) and taking into account the whole area to be remediated:

- n. 18 SVE points;
- distance between extraction points: $L=2(ROI) \cos 30 = 17 \text{ m}$
- Design flow rate = 2340 mc/h
- N. 4 blower (750 mc/h @ ΔP 150 mbar - each)
- N. 4 Granular Activated Carbon filters (4000 l – each – 2 duty/2 standby)







4.3 Radius of influence

The SVE Full Scale ROI is in line with the result of the SVE Pilot Test: about 9-10 m.

4.4 Off gas Treatment

As for off-gas treatment, #4 Granular Activated Carbon filters (4000 l - each- 2 duty/2 duty/2standby) were installed

4.5 Control parameters

To assess the effectiveness of the treatment the following parameters were monitored with the following frequency

Every two days:

- Monitoring of emissions into the atmosphere with short term tubes

On a weekly basis:

- Air flow and extraction rates
- ΔP in/out blowers, vacuum induced in each SVE extraction point
- Temperature in/out blowers
- VOC analysis before vapour treatment for each blowers
- Measure of piezometric level in monitoring points present in the area

Every two weeks

- VOC analysis of the treated vapours

On a quarterly basis:

- VOC, O₂, CH₄, CO₂ and vacuum induced at each SVE extraction and NP monitoring point

After the first three years monitoring plan has been modified in agreement with Authorities, and all the activities conducted on a weekly basis until 2016 were then conducted every two weeks. The above monitoring activities allowed also to calculate the VOC mass removal



6. Post treatment and/or Long Term Monitoring

6.1 Post treatment and/or Long Term Monitoring

The long term monitoring shows the effectiveness of the remediation technology applied.

The monitoring data collected allow to calculate quite a high CHCs mass removed from the unsaturated soils and show a clear evolution (depletion) over time of the CHCs concentrations measured at the SVE points.

In fact, considering both the pilot plant (active in the period May 2011 - May 2013) and the Full Scale plant (August 2013 - January 2019), the SVE system removed about 5238 kg of CHCs:

- Tetrachloromethane: 3171 kg
- Trichloromethane: 1814 kg
- Trichlorofluoromethane: 253 kg

From the results of quarterly analyses of VOC content in the vapour extracted from the extraction points in the area of the SVE intervention, isoconcentration maps for the above mentioned three contaminants in soil gas could be drawn.

These maps show a progressive decrease in concentrations over time after starting the SVE system.

Following the achievement of the technological limit of the SVE application (asymptotic value of the extracted mass) Stop & Go tests were performed. The tests showed a negligible rebound of the concentration and consequently the SVE system was stopped and confirmatory soil samples were taken which all showed CHCs concentrations below the CSR and also the CSC values.

7. Additional information

7.1 Lesson learnt

Although the characterization surveys, performed initially by drilling boreholes, indicated only few CSC exceedances of the CHCs concentration in the soil samples, the application of the SVE system allowed to remove a high mass of VOCs. In order to properly size remediation interventions, it is therefore important to carry out a more detailed characterization of the potential contamination sources in the unsaturated soils using advanced investigation techniques such as, for example, Soil Gas Survey, Membrane Interface Probe Investigations, Passive Soil gas Survey, etc..



7.2 Additional information

To assess the success of the remediation it is necessary to perform:

- trend analysis of each contaminant monitored over time with respect to the initial baseline value.
- quantification of extracted VOC mass over time

7.3 Training need

To ensure the achievement of remediation goals it is necessary to perform a good operation and maintenance of the overall system. To do this it is important that the system is managed by trained personnel.

Glossary of Terms

Term (alphabetical order)	Definition
VOC	Volatile organic compounds (VOCs) are organic chemicals that have a high vapour pressure at ordinary room temperature
CHCs	Chlorinated Compounds
SSTLs or CSR	Site Specific Target Level, which are named CSR in Italian regulation, are concentration target levels defined according to Risk Analysis procedure

1. Contact details - CASE STUDY: SVE n.14

1.1 Name and Surname	Ewa Szczebak
1.2 Country/Jurisdiction	Poland
1.3 Organisation	Arcadis
1.4 Position	Senior Environmental Specialist
1.5 Duties	Environmental consulting regarding soil and groundwater investigation, remediation, risk assessment. Project management.
1.6 Email address	ewa.szczebak@arcadis.com
1.7 Phone number	

2. Site background

2.1 History of the site

The site is an active railway area with 4 main tracks and some crossovers. Soil and groundwater was contaminated in 2010 due to a spill of app. 800 Mg of petroleum products (mostly diesel) after a train crash. The maximum admissible concentrations for soil and groundwater are exceeded for light and heavy petroleum hydrocarbons and BTEX.



2.2 Geological setting

Site soil consists largely of fine and medium sands, locally overlaid by sandy loam. Uppermost soil layer is man-made fill (consisting of sandy loam with crushed bricks) and railroad ballast below the tracks. The depth to groundwater is approximately 7 meters below ground surface on the railway area and approximately 5 m bgs on the outflow.

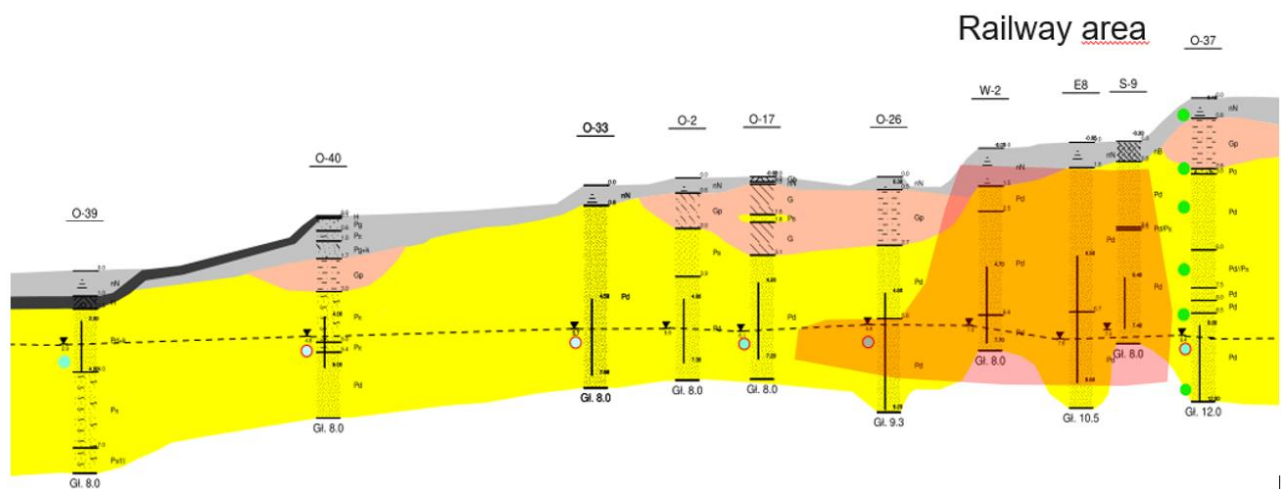

2.3 Contaminants of concern

The contaminants of concern detected in soil:

- Total Petroleum Hydrocarbons fraction C6-C12: BDL – 10,600 mg/kg
- Total Petroleum Hydrocarbons fraction C12-C35: BDL – 40,000 mg/kg
- Toluene: BDL – 57 mg/kg
- Ethylbenzene: BDL – 426 mg/kg
- Xylenes: BDL – 1,240 mg/kg

The contaminants of concern detected in groundwater:

- Total Petroleum Hydrocarbons fraction C6-C12: BDL – 4,990 mg/L
- Total Petroleum Hydrocarbons fraction C12-C35: BDL – 1,490 mg/L
- Benzene: BDL – 0.5 mg/L
- Toluene: BDL – 29 mg/L
- Ethylbenzene: BDL – 76 mg/L
- Xylenes: BDL – 200 mg/L



2.4 Regulatory framework

Due to a damage in environment after the spill of hydrocarbons the administrative procedure has been initiated. The first step was the extensive site investigation executed in a few rounds, including soil and groundwater sampling, monitoring wells installation and observation of groundwater and LNAPL behaviour. Based on the laboratory results of soil and groundwater samples, exceedances of relevant environmental standards were assessed. Remediation Action Plan was submitted to the Regional Environmental Agency, with the aim of remediation – achievement of soil and groundwater standards. After few a years of remedial system operation (LNAPL skimming enhanced with groundwater drawdown, and venting barrier on the outflow) the law in Poland has changed and the risk-based approach has been implemented. Therefore, the application for remediation based on human health and environmental risk-assessment was submitted to the Regional Environmental Agency. The proposed remedial goal is to limit the migration of contaminated groundwater. The SVE system is a part of venting barrier, consisting of air sparging (AS) system and soil vapour extraction (SVE) system. Due to close distance between barrier and office building, the SVE system is operating to prevent potential vapour intrusion into the building.

3. Pilot-scale application in field

3.1 Extraction system

The main goal for the SVE system was to extract contaminants in the gas phase in the area of air sparging system operation. Therefore, pilot tests were carried out on the injection wells screened in the aquifer. Since the geology of vadose and saturated zone is similar (fine sand along the whole profile), the radius of influence of extraction wells was established according to AS pilot tests.



3.2 Injection system

One injection well and three monitoring points were installed in a line for the field test of air sparging (AS) technology. The location of the test was based on future potential venting barrier location. Distance between the injection well and monitoring points was between 1.6 and 2.5 m and it was adjusted due to the presence of underground utility lines (i.e. power line, optic fiber, sewer system). The air was injected by a blower, to a depth of 1.7 – 2.0 m below the groundwater table.

3.3 Radius of influence

Radius of influence (ROI) at around 5 meters was calculated for the air sparging test (air injection into one well and observations in 3 points). The observed parameters were: groundwater level and pressure versus distance. A groundwater level increase of 0.1 m was considered as the boundary of the effect of AS well. Scheme of AS test is presented below.

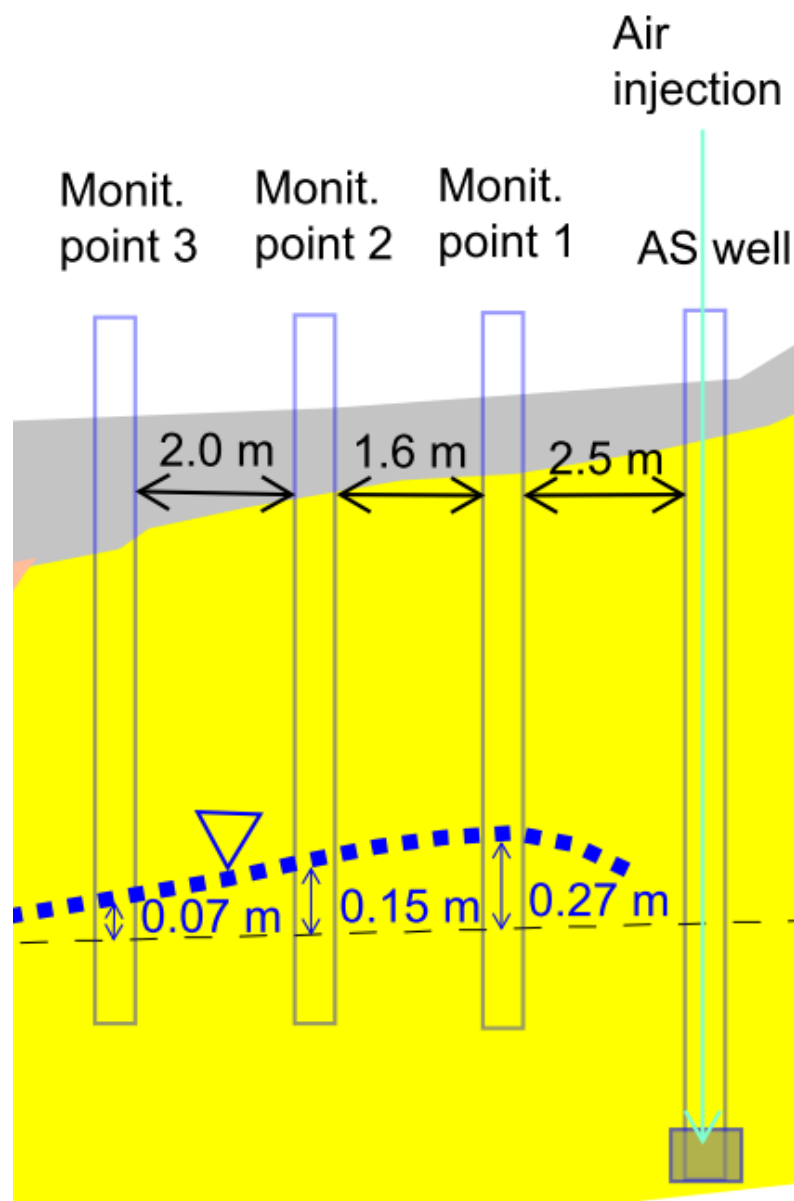



3.4 Off gas Treatment

No off gas treatment was installed for the pilot test, because the test was based on air injection, not extraction.

3.5 Control parameters

For the pilot scale of AS system, it was useful to monitor the oxygen concentrations in monitoring points and in surrounding GW monitoring wells. The increase of oxygen in groundwater was fast and direct proof of effectiveness of air injection.

4. Full-scale application

4.1 Extraction system

The SVE system includes the following equipment: a metal container measuring 3 m wide by 10 m long by 3 m high; 11 horizontal vapour extraction wells; and one air compressor. In addition, the system includes a filter with activated carbon to treat the contaminated air.

The soil vapour extraction system consists of eleven 2-inch diameter horizontal wells screened at depth of app. 4.0 – 4.2 m bgs. The wells are combined with pipelines and work as two separate lines, set between two lines of air injection wells.

The SVE system works at intervals alternately with AS system, time of each interval is half an hour.

4.2 Injection system

The air sparging system includes the following equipment: a metal container measuring 3 m wide by 10 m long by 3 m high; 13 horizontal air injection wells; and one blower. The AS system consists of thirteen 2-inch diameter horizontal wells screened at depth of approx. 7.0 – 8.2 m bgs. The wells are combined with pipelines and work as two separate lines, set between two lines of vapour extraction wells. The AS system works at intervals alternately with SVE system, time of each interval is half an hour.

4.3 Radius of influence

Radius of influence (ROI) was calculated for the air sparging test (air injection into one well and observations in 3 points) at around 5 meters. The observed parameters were: groundwater level and pressure versus distance. A groundwater level increase of 0.1 m was considered as the boundary of the effect of AS well. Scheme of AS test is presented below.

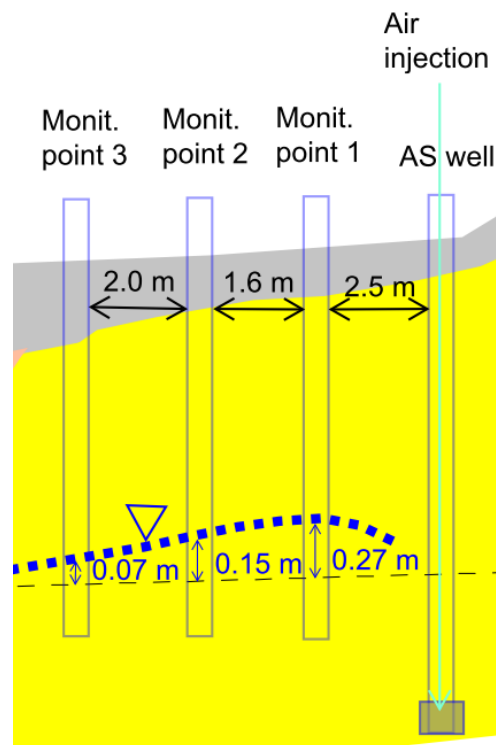



4.4 Off gas Treatment

Activated Carbon Adsorption is used as treatment method for off gas. A vertical filter with a capacity of 1 cubic meter is installed in the container. Granulated activated carbon is used as air emissions treatment.

4.5 Control parameters

- PID measurements are taken once a year in extraction points to check the effectiveness of vapour extraction.
- Periodically a PID measurements in the off-gas are taken to control the effectiveness of soil gas treatment.
- Water levels are measured regularly to control proper work of AS system.
- Contaminant concentrations and basic physical-chemical properties are measured in GW twice a year as part of groundwater monitoring programme for the site.

6. Post treatment and/or Long Term Monitoring

6.1 Post treatment and/or Long Term Monitoring

PID measurements have been taken once a year in extraction points to check the effectiveness of vapour extraction.



7. Additional information

7.1 Lesson learnt

1. **methodology and procedures:** before the installation of full-scale system, the hydrogeological data from 1-2 years of measurements (dependent on the local hydrogeology conditions) should be gathered and analyzed. It would help to avoid a situation of eventual groundwater level rise causing flow of the groundwater into extraction wells (i.e. danger of equipment damage). And for the AS system it would help to install injection wells to a reasonable and cost-effective depth.
2. **technical aspects:** the system generates a lot of heat, therefore the building where the equipment is installed should be adequately designed to decrease the indoor temperature in the summer (i.e. ventilation). Location of wells and related interdistance for the full scale system are determined also by the local conditions (i.e. underground utility lines, land accessibility). Therefore, it should be considered when designing the system to keep the proper influence area.
3. **regulatory aspects:** it would be much easier to conduct pilot studies of proposed remedial technology before the submission of Remediation Action Plan (RAP). Since after the entry into force of the new regulation, formally you should submit a RAP just after a contamination is acknowledged. Therefore, understandably, most of the clients prefers to submit the RAP before field tests. Then, if field test results show a lack of effectiveness of the proposed technology, RAP should be amended.



7.3 Training need

Training would be recommended both for consultants (for better understanding of the methodology and its needs) and for the authorities (for better understanding of the capabilities of SVE and the need of field tests prior the full scale system installation). Workshops and presentations about case studies are an effective learning tool.

Glossary of Terms

Term (alphabetical order)	Definition
AS	Air Sparging
BDL	Below Detection Limit
BGS	Below Ground Surface
BTEX	Benzene, Toluene, Ethylbenzene, Xylenes
GW	Groundwater
LNAPL	Light Non-Aqueous Phase Liquid
RAP	Remedial Action Plan – an official document submitted to the authority for approval
ROI	Radius of Influence

1. Contact details - CASE STUDY: SVE n.15

1.1 Name and Surname	Puricelli Sara, Marin Rosa Angela, Ricci Diego, Confalonieri Massimiliano
1.2 Country/Jurisdiction	Italy
1.3 Organisation	ARPA Lombardia
1.4 Position	
1.5 Duties	
1.6 Email address	s.puricelli@arpalombardia.it m.confalonieri@arpalombardia.it
1.7 Phone number	+39 031 2743913



2. Site background

2.1 History of the site

The area in question is an active industrial production site that carries out engineering activities and is located in Northern Italy.

The site was divided into three portions for different distribution and characteristics of the secondary sources and managed with different remediation approaches.

Unlike the other sites managed through reductive dehalogenation processes, the one in question provided for treatment through AS/SVE for the following reasons:

- in this portion there is no natural anaerobic degradation process of the chlorinated organic compounds;
- the speed of the local water table is significantly higher than the other two source areas (at least double) and would not allow an adequate residence time of the injected substrate in the intervention area, effectively nullifying its effectiveness.

There are no specific protocols for the management of the site, but the control and technical evaluation activities in support of the Municipality (proceeding administration appointed by the Region for the management of contaminated sites) are carried out by ARPA. ARPA Lombardia is an environmental protection agency established in 1999 that deals with the prevention and protection of the environment, supporting regional and local institutions in multiple activities: from the fight against atmospheric and acoustic pollution to interventions for the protection of surface and groundwater, from monitoring electromagnetic fields to investigations on soil contamination and remediation processes.

2.2 Geological setting

From the hydrogeological point of view, the site is characterized by a single undifferentiated aquifer, which rests on a rocky substrate about 35 m from ground level, as shown in the section below.

The hydraulic conductivity, in the portion of the site of interest is of the order of $3-4 \cdot 10^{-5}$ m/s, resulting in a rather high water table speed, with flow direction from West to East. The average subsidence of the aquifer is about -13 m from ground level.

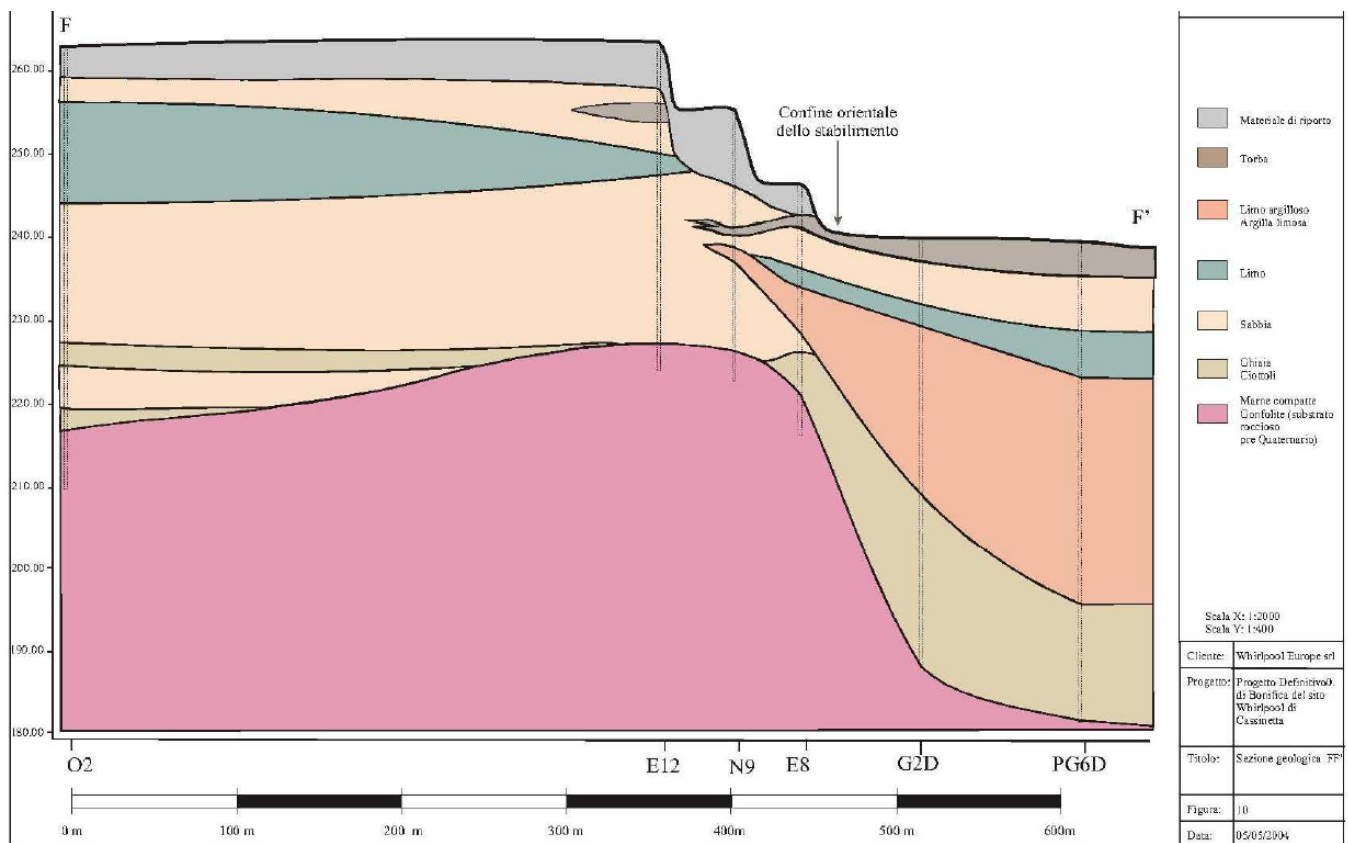



2.3 Contaminants of concern

Due to the production activities carried out, the groundwater was contaminated by chlorinated solvents, mainly tetrachlorethylene (PCE), trichloroethylene (TCE), 1,2-dichloropropane (DCP), cis 1,2-dichloroethene, 1,2-dichloroethane and vinyl chloride. In detail, TCE, DCP and PCE are to be considered primary pollutants, as they were actually used in the production processes of the plant during the 1960s and 1980s, while the other compounds are the products of the partial natural degradation of the previous ones.

The concentrations are very high, for some compounds in the order of mg/l. In particular, at the time of the start of the treatment in question were recorded maximum TCE values of 7.1 µg/l, DCP of 4 µg/l, PCE of 4100 µg/l and summation of organohalogen compounds of 4110 µg/l (thus demonstrating that most of the contamination is due to PCE), compared to regulatory limits for groundwater, respectively, of 1.5 µg/l, 0.15 µg/l, 1.1 µg/l and 10 µg/l for the summation.

The characteristic contaminants are essentially found in the saturated part of the subsoil, while in the unsaturated zone they were not detected in significant concentrations, thus excluding the presence of hot spot of contamination in the unsaturated zone.

2.4 Regulatory framework

The procedure was conducted pursuant to Legislative Decree 152/2006.



3. Pilot-scale application in field

3.1 Extraction system

The technique involved the combination of an air injection system at the bottom of the saturated area, Air Sparging (AS), and a system for extracting the vapours produced (Soil Vapour Extraction - SVE).

In detail, the first is aimed at stripping volatile contaminants present in groundwater, favouring their passage into the vapour phase and therefore their migration into the unsaturated portion of the soil, from which they are then removed thanks to the SVE system in the atmosphere following appropriate treatment.

The pilot scale tests were carried out in the period between April 2008 and June 2009, autonomously from the party without the adversary of ARPA.

3.2 Injection system

As in the saturated area, compressed air was injected.

3.3 Radius of influence

The range of influence was obtained from direct tests in the field, evaluating the depression exerted in the control wells. Support model simulations were not used.

3.4 Off gas Treatment

The gas treatment system is similar to that which was then implemented in the full-scale plant, described in detail in sheet 4.4.



3.5 Control parameters

The monitoring of the pilot plant consisted in the quantification of chlorinated compounds both in the air extracted from the SVE wells installed in the unsaturated state, and in the groundwater taken from the wells in the saturated state.

At the end of the pilot plant, quantities greater than l.q. only for TCE and PCE (expressed in mg/l) were found in waters, while the other chlorinated compounds possibly present showed negligible concentrations.

From the data found in the extracted gases it emerged that:

- the extraction of vapour phase contaminants from the SVE wells from the unsaturated soil was efficient and allowed the achievement of concentrations of chlorinated compounds in the vapours of up to 1 g/m^3 ;
- the quantity of extracted contaminants is significantly greater in the deepest unsaturated wells among those used, that is, in those cracked near the capillary fringe compared to that of the more superficial wells;
- - the contaminants present in the extracted vapours essentially come from the stripping of groundwater and not from the presence of contaminants in the unsaturated zone; in fact, in the absence of compressed air injection, concentrations of contaminants were found to be considerably lower in the interstitial vapours than those detected with the AS system on.

4. Full-scale application

4.1 Extraction system

4 SVE wells were used and installed in the unsaturated domain, of which 1 was existing and 3 were installed new, headed about 1 m above the surface of the aquifer (indicatively therefore up to an altitude of 12 m) and cracked for 5 m.

Each SVE well was combined with a pair of AS wells, which were bored in the immediate vicinity of the saturated domain.

The figure shows the plan of the AS/SVE system built on the site. In it are indicated:

- in blue the wells connected to the AS plant (the PAS1S-1D pair had been used in the small-scale intervention);
- in red the wells connected to the SVE plant (SVEFT3S was used for the pilot plant);
- in green the piezometers that are planned to be used as water monitoring points.

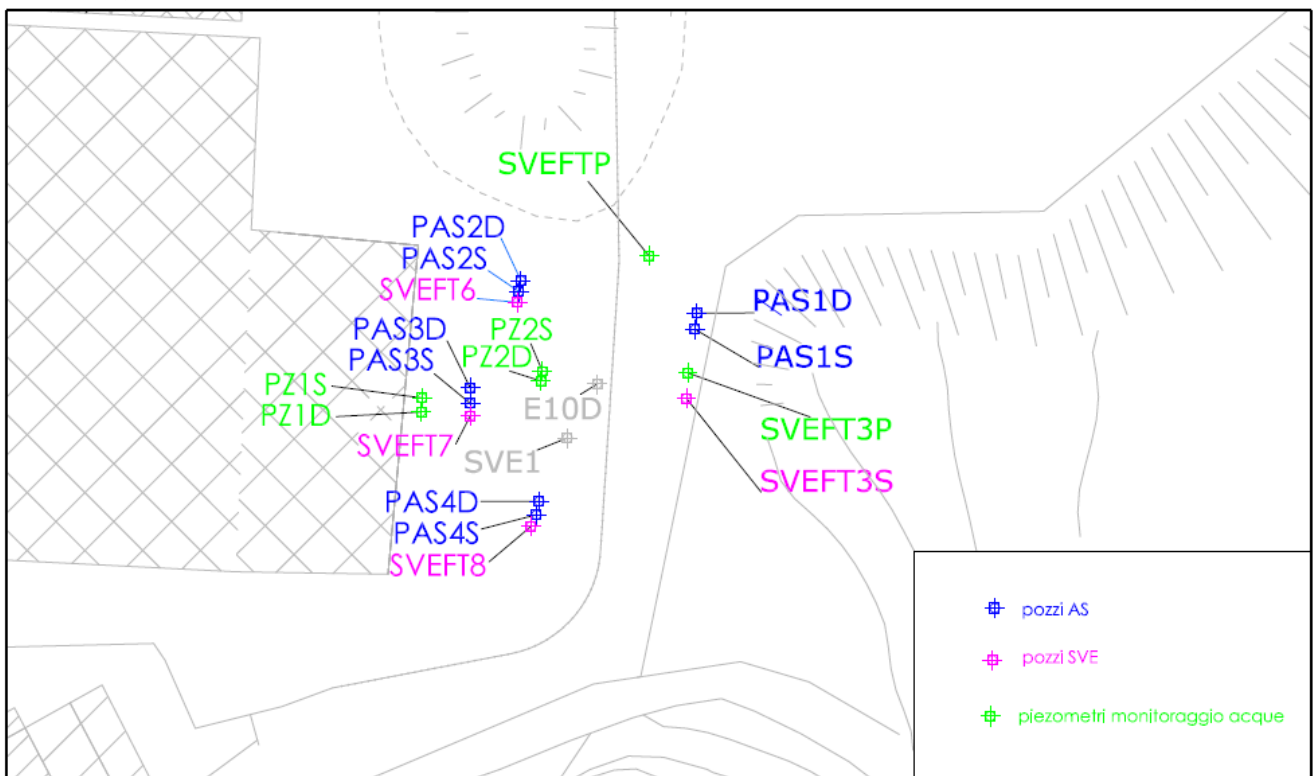

In detail, the SVE system consisted of the following components:

- 1 centrifugal aspirator with 2.5 - 3 kW power, with a flow rate of 150 Nm³/h at a depression of 120 mbar;
- 4 steam extraction pipes from as many SVE wells;
- 4 wellhead connections, designed for the measurement of air flows, depression and the taking of steam samples;
- 4 butterfly valves to control the flow rates of each suction well;



- 4 vacuum gauges;
- 4 valves for fine adjustment of the extracted flow rates;
- 1 manifold for collecting the suction pipes arriving from the wells;
- 1 dust collector filter for atmospheric air;
- 1 condensate separator, with relative booster pump;
- 1 activated carbon filter for condensate treatment;
- 2 activated carbon filters for air, connected in series and intended for the treatment of vapours;
- connection pipes, valves, various fittings, measurement and regulation sections, pneumatic quick couplings;
- command and control instrumentation (electrical panel in common with the AS system) which allowed manual or automatic operation;
- 1 container housing the entire system (shared with the AS system).

The system has been designed to guarantee a flow rate of continuously extracted vapours equal to at least double the flow rate of the air blown into the groundwater, and therefore overall capable of sucking at least 120 Nm³/h.

In the event of operating anomalies, a GSM telephone dialer was arranged who could send the error reports to specialized personnel able to restore the functionality of the system.

All quick-connect points have been prepared for taking steam samples and for inserting the following portable field instruments online:

- digital or analogical vacuum gauges for measuring depression;
- PID probes for indirect detection of VOC concentration;
- anemometers for measuring the extracted airflow.

The full-scale plant was started up in March 2013.

Here are some pictures of the AS/SVE system.





4.2 Injection system

4 pairs of groundwater insufflations wells (AS) were built, of which, n. 1 was existing and n. 3 were newly installed, each capable of guaranteeing the injection for 5-10 minutes of approximately 30 Nm³/h of air at an injection pressure of at least 3 bar.

Approximately, for each side-by-side, a well has a depth of 25 m from b.g.l. and the other 30-35 m from ground floor; given the nature of the compounds, with a density greater than that of water, the cracked section is located on the bottom and has a length of about 50 cm.

The AS system consisted of the following components:

- 1 rotary compressor (able to guarantee air flows of at least 70-100 Nm³/h at a pressure of 4 bar, imposing a maximum pressure of 10 bar);
- 1 storage tank for compressed air (volume 270 l), equipped with a 0-16 bar pressure gauge and safety valve for venting overpressures;
- 1 airtight compressed air delivery pipe to the distribution system, equipped with a pressure regulator (0-10 bar);
- 8 independent insufflations pipes;
- 8 wellhead connections;
- 8 analogical flow meters and 8 pressure gauges;
- 8 timed solenoid valves for air distribution in AS wells;
- 8 manual ball valves for regulating the airflow on the individual wells;
- connection pipes, valves and various fittings, measurement sections by means of float flow meters and flow regulation;
- command and control instrumentation (electrical panel in common with the SVE system);
- 1 container housing the plant (shared with the SVE system).

Downstream of the storage tank, the compressed air passed through a de-oiler filter equipped with a timed vent valve, which allowed the elimination of any oily condensate formed in the machine, preventing it from entering the groundwater.

In order to ensure the efficiency of the insufflations process, the system was set to automatically blow about 30 Nm³/h of air into a pair of wells for a duration of 5-10 minutes, while the other three pairs remained inactive.



4.3 Radius of influence

The range of influence was defined based on the evaluation of the pilot test.

4.4 Off gas Treatment

Before the final discharge into the atmosphere, the extracted vapours were subjected to purification treatment with the following characteristics:

- number of filters 2;
- total filter volume 800 l;
- quantity of GAC (granular activated carbon) 360 kg total;
- filter section 800 mm
- filtration speed 0.11 m/s
- total contact time 14.4 s.

These characteristics, established on the basis of what was verified with the pilot scale test, ensured compliance with the limits set by Legislative Decree 152/06 for each of the site-specific gaseous compounds.

The protocol provided for the replacement of spent activated carbon and its subsequent dispatch for disposal/regeneration in authorized external plants to be carried out before the reduction in the efficiency of the vapour treatment system would not allow compliance with the emission thresholds.

4.5 Control parameters

The monitoring plan included:

- monitoring of the vapours extracted from the SVE wells and entering/leaving the vapour treatment plant;
- periodic inspection, maintenance, and adjustment of the AS/SVE system;
- the collection and analysis of water samples, measurement of chemical-physical parameters of the water (dissolved oxygen, redox potential, pH, temperature) in 9 piezometers, available in the intervention area as well as 1 new downstream (G16) made at approximately 110 m away from the treatment area, aimed at evaluating the influence of the AS treatment on the measured solvent concentrations with respect to a blank campaign at the initial time

In fact, immediately after the start-up of the SVE plants (in March 2013) and before the start-up of the AS system, a sample of vapours was taken from each of the suction wells, analyzed for chlorinated solvents, which constituted the "blank" as not yet influenced by the simultaneous start of the insufflations of air in the saturated portion of the local subsoil. After that, the AS system was also started.

The location of the monitoring points of the 9 monitoring piezometers is visible in the following figure.

The monitoring during the execution of the intervention took place on a quarterly basis.

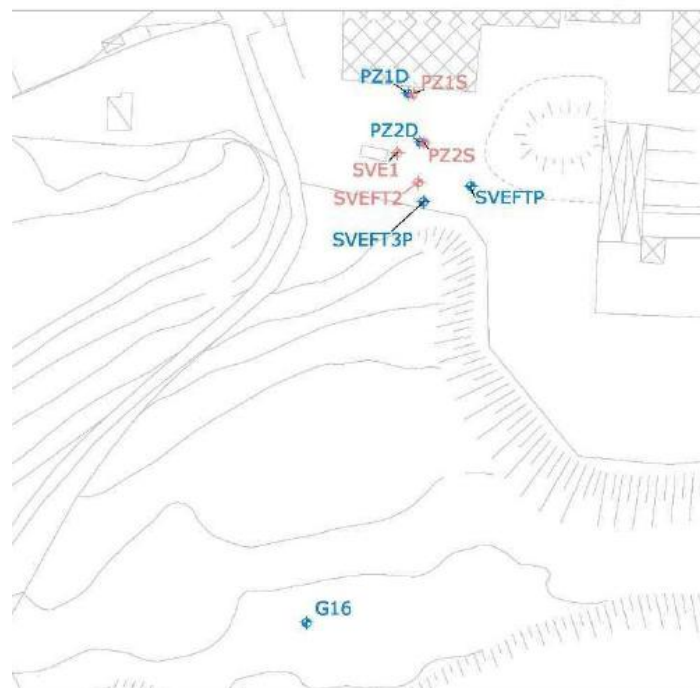



5. Enhancements to SVE

5.1 Pneumatic and/or hydraulic fracturing

Discontinuous operating periods of the plant have been implemented, as described in § 6.1, in order to intervene on rebound phenomena and periodically evaluate the plant's cost/benefit effectiveness.



6. Post treatment and/or Long Term Monitoring

6.1 Post treatment and/or Long Term Monitoring

From the evaluation of the monitoring data, it was found that the wells from which the greatest extraction of contaminants takes place are SVEFT7 and alternatively SVEFT8. From the start of the intervention in July 2017, considering the total flow rate detected on the delivery section of the blower and the concentrations detected, it was possible to estimate the mass of contaminants extracted during the execution of the AS/SVE intervention equal to approximately 645 kg of organochlorinated solvents, consisting mostly of PCE.

On the occasion of the monitoring in July 2017 it emerged that:

- in the water taken from the piezometers of the deep portion of the aquifer, a clear reduction in the concentrations of contaminants present, up to over 90% of the initial values, and in particular of PCE and TCE, emerged;
- even in the waters taken from the piezometers of the surface portion of the aquifer, a decrease in concentrations was found even up to over 90% of the initial values;
- in the waters of the G16 piezometer, located downstream from the intervention area, fluctuating concentrations were recorded after treatment but with a decreasing trend, however with still considerable residual values. This was probably due to the considerable distance from the intervention area and the presence of a peaty horizon at a depth of about 6 m which could have limited the impregnation of the contaminants thus allowing their release over time. It was considered that it would have been necessary to wait a very long time before having an effect similar to that obtained in the intervention area. Following the concentrations detected in this piezometer, hydraulic containment was active downstream to it;
- overall, the concentration of contaminants in the extracted vapour stream decreased significantly over time, but detectable concentrations were still present in the extracted stream.

In general, from the examination of the results of the analyzes performed and the graphs that show its trend, the decrease in the concentrations of the summation of chlorinated solvents with respect to t_0 emerged over time and the asymptote conditions seemed to be reached in the intervention area.

In May 2018 and up to December 2018, the AS/SVE systems were therefore shut down, and new monitoring was carried out starting from the end of the following month. There was thus an increase in concentrations in the groundwater of the intervention area, in



particular in the more superficial PZ1S and Pz2S piezometers.

It was therefore considered useful to restart the plant again for a further period of six months in order to allow further massive extraction of the contaminants present, until July 2019. The monitoring carried out following the reactivation of the plant certifies the removal of a mass of contaminants equal to 16 kg over a period of approximately 7 months.

The analytical results of the PZ1S and PZ2S piezometers show, in the period following the reactivation of the system, still significant concentrations of chlorinates in the PZ1S and PZ2S piezometers.

The AS/SVE intervention was deactivated in July 2019 and a new monitoring took place 6 months after the shutdown.

Overall, the removal of approximately 660 kg of PCE has been estimated during the operating period (2013-2020), with a decreasing trend over time.

In 2020, the authorities accepted the request to shut down the system because from the cost-benefit ratio of the treatment it emerged that it was no longer the best intervention technique at sustainable costs. This decision was reinforced by the fact that there is a hydraulic barrier at the border, and therefore an operational safety device (MISO).

The monitoring of groundwater after the works, downstream of the closure of the intervention, was prescribed on a quarterly basis until the remediation of the control piezometers provided for the area is completed, and then for another 2 years every six months.



7. Additional information

7.1 Lesson learnt

The remediation intervention allowed the removal of part of the contaminants, but did not prove decisive, as can be seen from the analysis of the analytical data on groundwater. It can be hypothesized that the specific geological and hydrogeological characteristics of the site have reduced the effectiveness of the scheme, in particular for the fine lithology of the area (peat, silt and clayey sand) and for the scarce subsidence that with seasonal fluctuations, prevented as a matter of fact the volatilization of the contaminants in the interstitial spaces of the unsaturated portion and the subsequent removal.

It could have been appropriate to undertake an evaluation of the behaviour of the plant, both for the purposes of designing it and predicting its behaviour, also to optimize its management, by means of a two-phase numerical modelling simulation, which considered the behaviour of air and water in the aquifer, evaluating the phase passage of pollutants over time and as a function of air injection/gas extraction, such as Petrasim.



7.2 Additional information

The Final Reclamation Project was based on a double criterion to establish the achievement of the reclamation:

a) limits in the treatment area that ensure compliance with the legal values (CSC) on the legal boundary of the site derived from the application of groundwater transport models used for the Risk Analysis. In detail, the reclamation limit concentrations were calculated using the Ogata Banks model, both for the deep aquifer and for the superficial aquifer, applying the appropriate values of the hydrogeological parameters for each, obtained through dedicated calibration.

The following table summarizes the concentrations ($\mu\text{g/l}$) admissible at the end of the remediation operations.

TCE	PCE	DCP	DCE	DCA	VC
2.57	17.85	1498	42.69	29.57	2.98

b) technical remediation limit, was considered reached when the decrease in the concentrations of contaminants in the groundwater stabilized around an asymptotic value of the reduction in the concentrations of chlorinated solvents below the limit values calculated with the Ogata Banks model. In particular, following the identification of the achievement of the asymptote (verified by evaluating the analytical results of 3 subsequent samplings), provisions had been made for the suspension of the remediation activities and the subsequent execution of verification samplings on a quarterly basis and then half-yearly.



7.3 Training need

There is a need for specific training for more in-depth design assessments, such as the use of two-phase numerical models to design and manage an AS/SVE system adequately and in a site-specific manner.

7.4 Additional remarks

Here are some indications on costs:

1	Organizzazione, supervisione attività / Report finale	€	9.000,00
2	Realizzazione pozzi e piezometri	€	52.000,00
3	Installazione impianti / Demobilizzazione impianti a fine intervento	€	12.600,00
4	Gestione e monitoraggio intervento	€	47.600,00
		€	121.200,00

Glossary of Terms

A glossary will help a you to maintain the level of precision necessary for key terms and maintain consistency across the text. We found out that sometimes terms that sounds similar like “contaminated” and “polluted” are used in the same way as synonyms in some country, while in other they have different meanings (due to legislation or for other reasons). So fill in this glossary for your key elements and of course for acronyms.

Term (alphabetical order)	Definition
AS	Air Sparging
GAC	Granular activated carbon
l.q.	Limit of quantification
MISO	Operational safety device
PID	Photoionization detector
PLC	Programmable logic controller
SVE	Soil Vapour Extraction
VOC	Volatile organic compound

1. Contact details - CASE STUDY: SVE n.16

1.1 Name and Surname	Confalonieri Massimiliano
1.2 Country/Jurisdiction	Italy
1.3 Organisation	Agenzia Regionale per la Protezione dell'Ambiente (ARPA) della Lombardia
1.4 Position	Dirigente RUO BARAE
1.5 Duties	
1.6 Email address	m.confalonieri@arpalombardia.it
1.7 Phone number	+39 335 531 8045

2. Site background

2.1 History of the site

The area in question coincides with a discontinued fuel point of sale (classified as an unhealthy 2nd class industry pursuant to the Municipal Hygiene Regulations), located along Via Lorenteggio in Milan in a city context with mixed tertiary, commercial and residential use.

The site is identified by map 18 of Sheet 505 of the NCT of the Municipality of Milan.

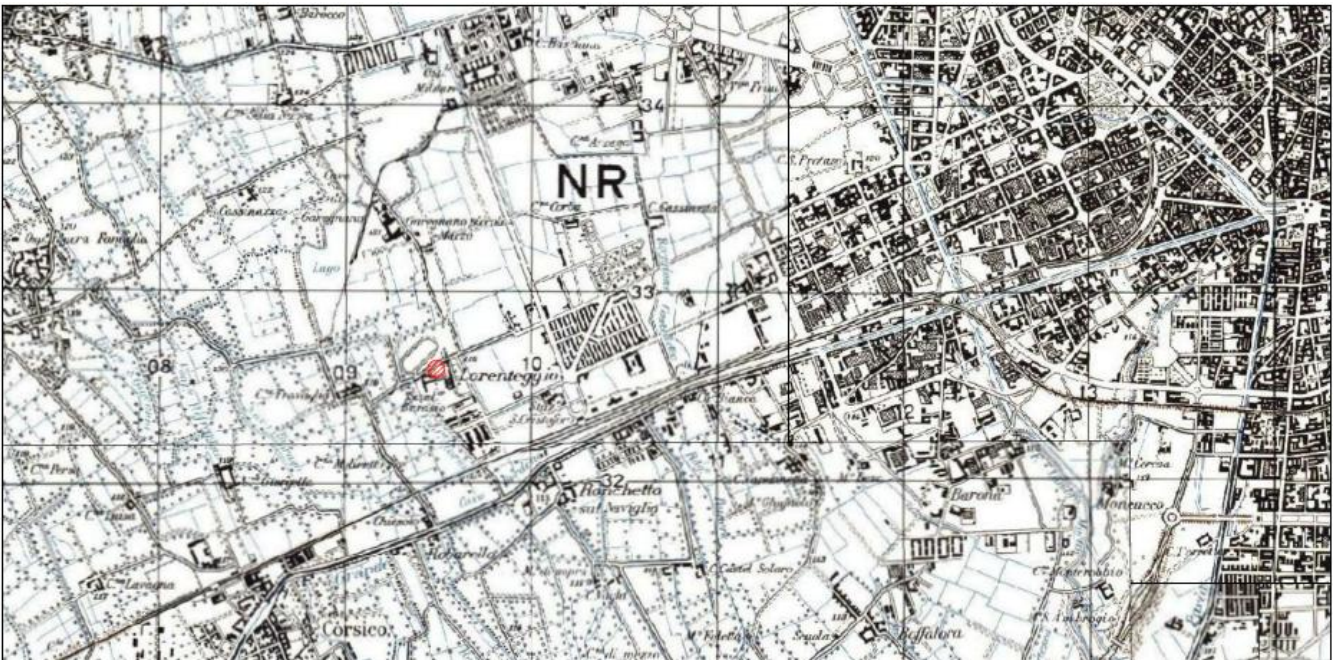

The site does not fall within the perimeter of a SIN and is not affected by any protocols stipulated with the PA.

The plant was located in an area owned by a third party, used with a lease agreement and with the obligation to return it to the owner upon definitive cessation of the activity.

Currently, after the characterization and implementation of the remediation work (not yet completed), the site - after being returned to the property owner- looks like an entirely asphalted area equipped with a public car park at ground level.

The commercial settlement in question, following the temporary cessation of the sale of fuels requested by the managing oil company (with a note dated 03/24/2011) approved by the Municipality of Milan (with note prot. 266874/2011 of the Ufficio Carburanti del Settore Attuazione Mobilità e Trasporti), ceased all activities in 2011.

The site was therefore subject to cleaning and inerting the tank fleet, with interventions



carried out in April 2011.

Subsequently, in application of municipal regulations, the site was the subject of a preliminary environmental investigation campaign carried out in conjunction with ARPA. The results of this preliminary environmental check have shown that the reference CSCs have been exceeded and initiated the procedure pursuant to Title V, which saw the presentation, approval and execution of the Characterization Plan as a first step.

2.2 Geological setting

The stratigraphy of the site reconstructed with the surveys delineates a soil of mainly sandy matrix. In detail, the lithological sequence found can be summarized as follows:

- mixed material - Mixed material, essentially consisting of medium sand with the presence of gravel and pebbles that extends from 0 m from ground level about 2 m from ground level;
- silty sand and sand with gravel - fluvioglacial alluvial deposit consisting of alternating levels of silty sand and sand with gravel, extending from 2 m from ground level to 16 m from ground level.

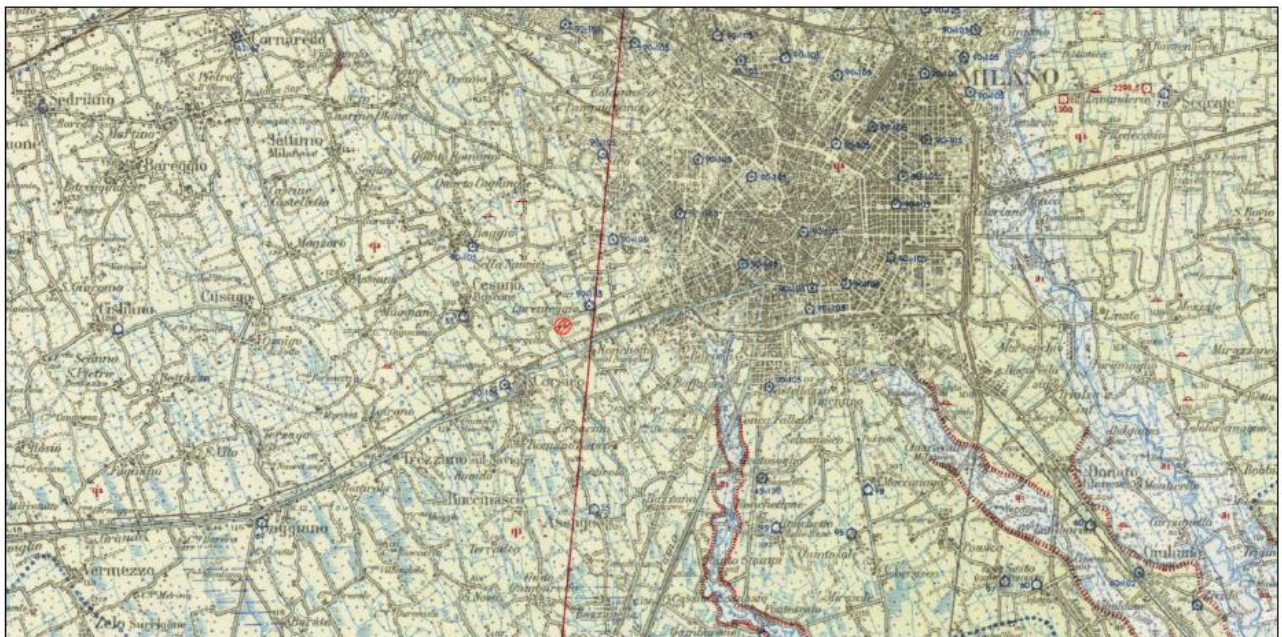

The environmental characterization survey carried out made it possible to identify a free aquifer with high permeability, contained within the alluvial deposit with gravels. The measurements of the piezometric levels performed during the characterization phase indicate an average groundwater depth of about 8.00 m from the p.c., i.e. a water table level that is around 109 m a.s.l.

Over time, the phreatometric checks carried out during the groundwater monitoring campaigns have highlighted the persistence of constant conditions in the direction of flow and periodic variations in the subsidence in a range of about 2 m.

The level measurements, together with the data deriving from the altimetry survey,

made it possible to reconstruct during the characterization phase the trend of the water table, which shows a prevailing flow direction towards ESE and an average hydraulic gradient of approximately 0.16 %.

The direction of flow of the water table was always confirmed by the phreatometric data acquired during the monitoring carried out on the site.

The average transmissivity of the aquifer calculated on the basis of the Pilot Tests described below equals to $0.1 \text{ m}^2/\text{sec}$.

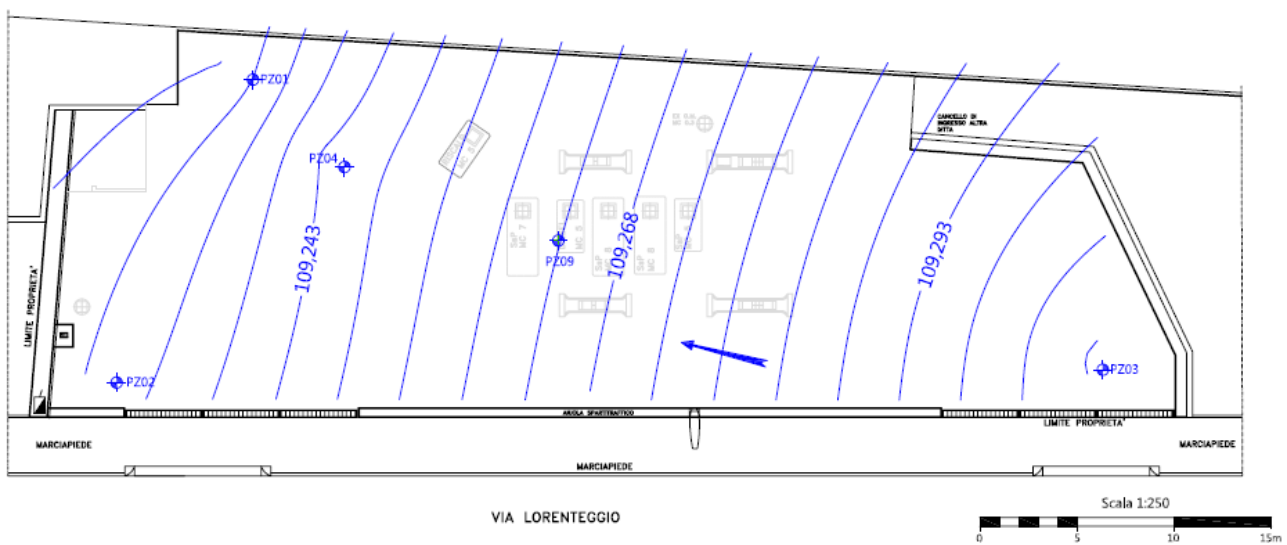

The contamination detected was in the deep soil (SP), starting from the level of the basement level of the underground tanks (about 4 - 5 m from the local p.c.); the local water table was also contaminated.

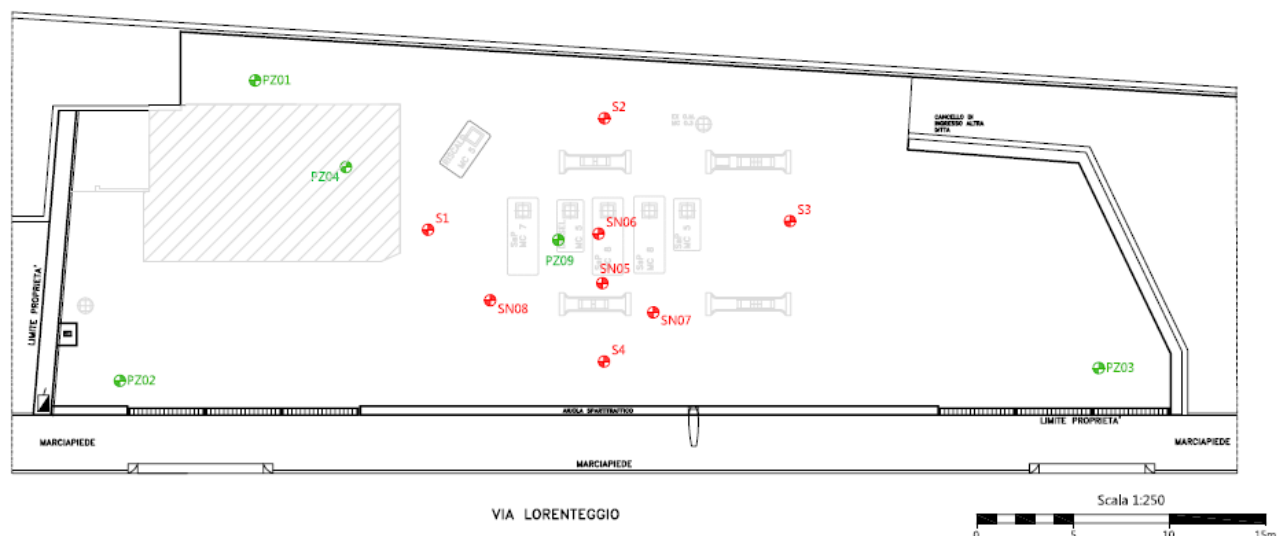



2.3 Contaminants of concern

The preliminary environmental investigation phase (IA), carried out at the same time as the removal of the tank park, concerned: walls and bottom of the excavation resulting in the removal of existing tanks on site, bottom of the resulting excavation after the removal of a small tank for the storage of used oils.

Analytical tests were carried out on the samples taken, aimed at determining the concentration values of heavy and light hydrocarbons (C <12 and C 12 - 40), IPA, BTEXS, Pb and MTBE.

The results of the analytical assessments were compared with the acceptability limits (CSC) set by current legislation (in particular table 1, column A of annex 5 to title V of part IV of Legislative Decree 152/06 and subsequent amendments and additions, considering that the area in question will be returned to the property once the decommissioning of the PV is completed) for the quality of the soil/subsoil matrix with respect to possible contamination.

The results of the control analyzes carried out by ARPA showed the presence of exceedances of the CSCs in particular for petroleum hydrocarbons (C > 12).

This evidence led to the continuation of the proceedings pursuant to Title V of Part IV of Legislative Decree 152/06, the communication of which was made in advance by the obliged party pursuant to art. 249 of the same Legislative Decree 152/06.

The site was therefore the subject of a Characterization Plan assessed and approved during the dedicated Services Conference and subsequently authorized by the Municipality of Milan with the PG 790255/2012 deed of 04/12/2012.

The results of the characterization showed that the reference CSCs were exceeded (col. A of Tab. 1 of annex 5 to Title V of part IV of Legislative Decree 152/06) for parameters C <12, C > 12, BTEXS (benzene, toluene, xylenes, ethylbenzene) in the unsaturated soil matrix and for the parameters (Tab. 2 of Annex 5 to Title V of Part IV of Legislative Decree 152/06) total hydrocarbons n-hexane, benzene, xylenes in addition to MtBE and EtBE (with reference to the values indicated by ISS, used at the time, not being regulated at that date) for the local groundwater matrix.

Pending the continuation of the procedure, an intervention by MISE was activated, implemented through a system for the extraction of water from the local groundwater (the discharged water was initially collected and disposed of as liquid waste, awaiting authorization from the competent authority to discharge it into the public sewer system).

The obliged subject therefore presented (pursuant to Article 242 and following, as



Ministerial Decree 32/2015 was not yet in force) a risk analysis report and related remediation project to be implemented with the simultaneous intervention on the groundwater matrix (by P&T) and on unsaturated soil/subsoil (by SVE and AS). The risk analysis and remediation interventions were evaluated and approved in the Services Conference and then authorized by the Municipality of Milan.

2.4 Regulatory framework

- “Linee Guida Serbatoi Interrati” ARPA - Lombardy, Milan - April 2004;
- Law 9 December 1998, n. 426;
- Legislative Decree 11 February 1998, n. 32;
- Legislative Decree 3 April 2006, n. 152 "Norme in materia ambientale";
- Legislative Decree 16 January 2008, n. 4 “Ulteriori disposizioni correttive ed integrative del decreto legislativo 3 aprile 2006, n. 152 ”;
- Law 28 January 2009, n. 2;
- Legislative Decree 3 December 2010, n. 205";
- Law 9 August 2013 n. 98;
- DM 31/2015
- D.G.R. Lombardy 10 February 2010 n. 8/11348;
- ISPRA (formerly APAT), October 2010 "Protocollo ISPRA-INAIL (ex-ISPEL) per la valutazione del rischio associato all’inalazione di vapori e polveri, in ambienti aperti e confinati nei siti di bonifica – Rev.0";
- ISPRA (formerly APAT), June 2009 "Appendice V – Applicazione dell’Analisi di Rischio ai Punti Vendita Carburante ai Criteri metodologici per l’applicazione dell’analisi assoluta di rischio ai siti contaminati" (Appendix V);
- ISS/ISPEL database (update 2018);
- ASTM E2081-00 (2004), “Standard Guide for Risk-Based Corrective Action”, ASTM International
- APAT, June 2008 "Documento di riferimento per la determinazione e la validazione dei parametri sito-specifici utilizzati nell’applicazione dell’analisi di rischio ai sensi del D.Lgs. 152/06";
- APAT, March 2008 "Criteri metodologici per l’applicazione dell’analisi assoluta di rischio ai siti contaminati rev. 2".

3. Pilot-scale application in field

3.1 Extraction system

The remediation approach involved the application of a Pump and treat (P&T) intervention on groundwater (with subsequent reintroduction in the hydrogeological upstream groundwater) and a joint intervention of air sparging (AS) and soil vapour extraction (SVE) on unsaturated soil.



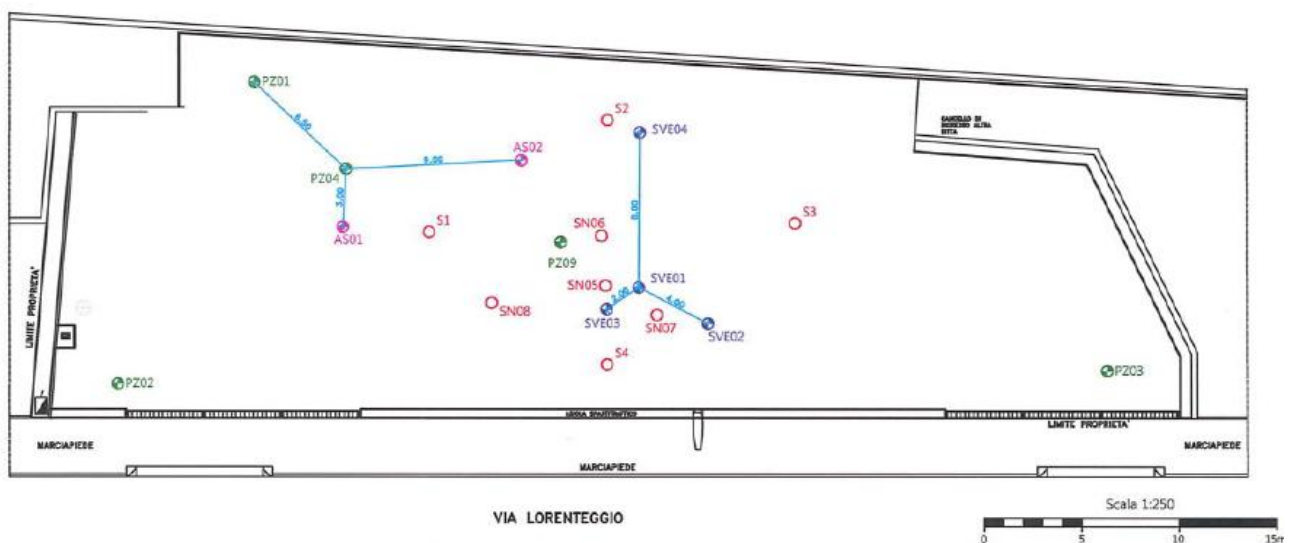

In order to assess the applicability of the AS (Air Sparging) technologies for the aquifer and SVE (Soil Vapour Extraction) for the unsaturated soil to the site under examination, pilot tests of AS and SVE were performed.

These results showed that neither the introduction of air into the groundwater nor the extraction of air from the subsoil have significant effects on groundwater levels at the design flow rates of the plant.

On the scale of the pilot test, n. 4 points for the execution of the Soil Vapour Extraction test were prepared by core destruction perforation and pushed to a depth of 6 m from the local p.c., then equipped with 2" PVC piping.



LEGENDA

-  Sondaggi realizzati per la caratterizzazione ambientale del sito
-  Piezometri realizzati per la caratterizzazione ambientale del sito
-  Punti di Air Sparging da realizzare
-  Punti di SVE da realizzare

In order to assess the applicability of the SVE technology to the site in question and determine the range of action induced in the ground by the suction of air, a step test was conducted by placing a point in suction and using other wells as monitoring points.



3.2 Injection system

In the pilot scale application, specially drilled wells were used (boreholes pushed up to 6 m from the local p.c., equipped with a 2" PVC pipe) and the carrier gas used was atmospheric air (the same then used at the real scale).

3.3 Radius of influence

In the pilot scale application, a step test was carried out, placing the SV01 point in suction with increasing flow rate steps and using points SV02, SV03 and SV04 as monitoring points.

The extraction and blowing system used a dry vane compressor. For the treatment of interstitial vapours extracted from the subsoil, activated carbon cartridges for air were used.

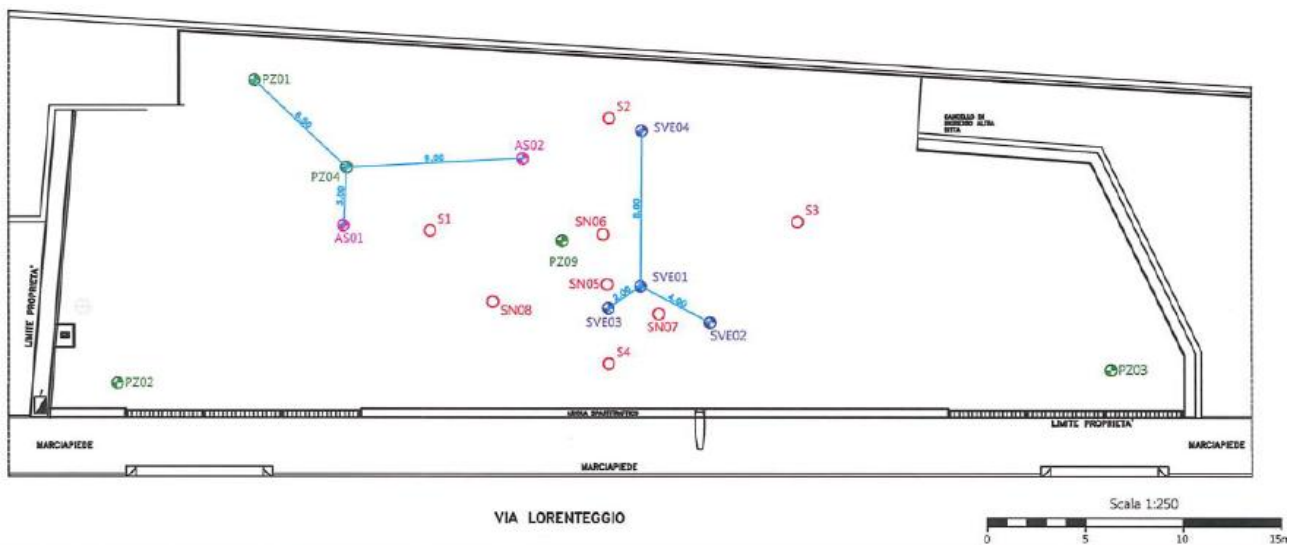

The extraction of unsaturated air at point SV01 induced, at the maximum flow rate used ($80 \text{ m}^3/\text{h}$), a depression of the order of 15 mbar at the suction point and a maximum of 0.3 mbar in the SV02 located 4 m from the extraction point.

As the extraction rate varied, there was a sharp increase in the amount of Volatile Organic Compounds (VOCs) extracted from point SV01, with maximum values of the order of 300 ppm.

Considering, in accordance with the industry guidelines, the value of 0.25 mbar as the minimum significant depression to have an influence on the suction side, it is possible to establish a range of action of the SVE, at the maximum tested flow rate, between 2 and 3 m.

In order to verify the applicability of the AS technology to the site under examination, determine its range of action and verify the combined effect AS + SVE, a step test was carried out to blow air inside point AS01, using points SV02, SV03, SV04, AS02, PZ04 and PZ01 to monitor the test parameters. In the combined test point SV01 was placed under



suction, with a constant flow rate and set by determining the flow rate steps of the air introduced in point AS01.

A second test carried out on AS and SVE kept the flow of air extracted from point SV03 constant, while in connection with point AS01, flow rate steps of injected air were set.

At the end of the SVE tests, exploiting the oxygenation of the soil induced by the recall of air, a BV test was performed by monitoring the indicator parameters of any possible bacterial activity capable of decomposing the hydrocarbon components.

The parameters used for the dimensioning of the SVE system were chosen according to the results of the pilot test, which can be summarized as follows:

- Calculated radius of influence, ROI: 2.7 m from the vapour extraction point;
- Depression applied to each point SVE, PEa: from -10 to -20 mbar;
- Extraction rate for each SVE point, QEa: about 70 Nm³/h.

From the results of the pilot tests and from the definition of the Conceptual Model of the site, the parameters for calculating the duration of the remediation were defined:

- Extraction rate for each SVE point, QEa: about 70 Nm³/h;
- Air inlet pressure at each point AS: QIa: about 300 mbar Nm³/h;
- VOC concentration entering the remediation system, Ci: 430 mg/Nm³;
- Estimated volume of the source of contamination, V: 800 m³;
- Concentration of contaminants in the source of contamination, Cc: 8802 mg/kg.

The overall duration of the reclamation of the subsoil was estimated in the project in the order of 3 years.

3.4 Off gas Treatment

For the pilot plant, a capture system was used consisting of activated carbon cartridges, which were then disposed of (code EER 19.13.02).

3.5 Control parameters

The pilot scale monitoring and sampling plan evaluated the concentration variations of VOCs (volatile organic compounds) using a portable PID photo ionizer and estimated the triggering of bacterial activity in the soil by evaluating the variations of O₂ and CH₄. To assess full-scale applicability, the following were measured, as the operating flow rates vary:

- extraction flow, depression and VOC concentration on the air extraction line.
- depression and VOC concentration on monitoring points

In the AS and combined AS and SVE test the following were monitored:

- inlet flow rate and pressure on the air inlet line
- extraction flow, depression and VOC concentration on the air extraction line.
- VOC concentration, temperature, dissolved oxygen and groundwater level at the monitoring points during the first test
- depression and VOC concentration on the monitoring points during the second test

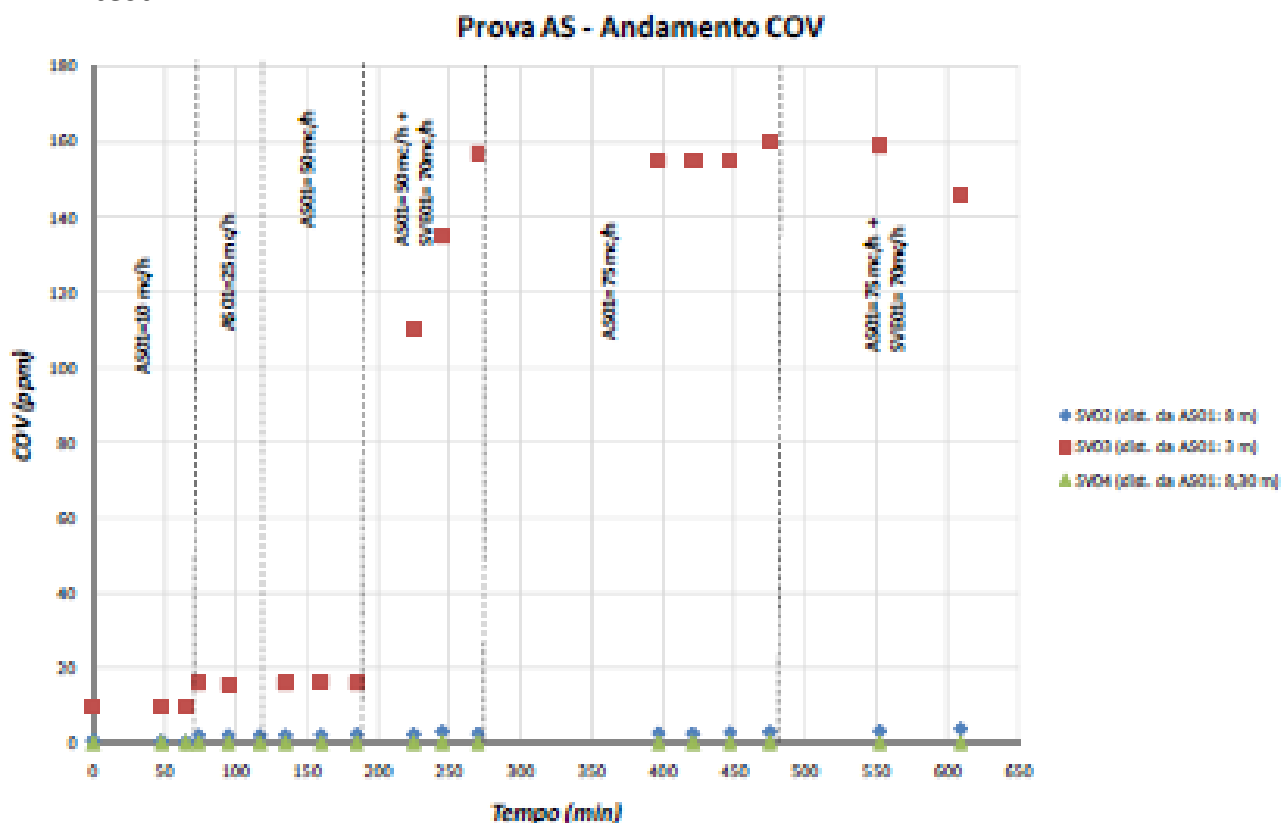

First test results

Prova combinata AS-SVE

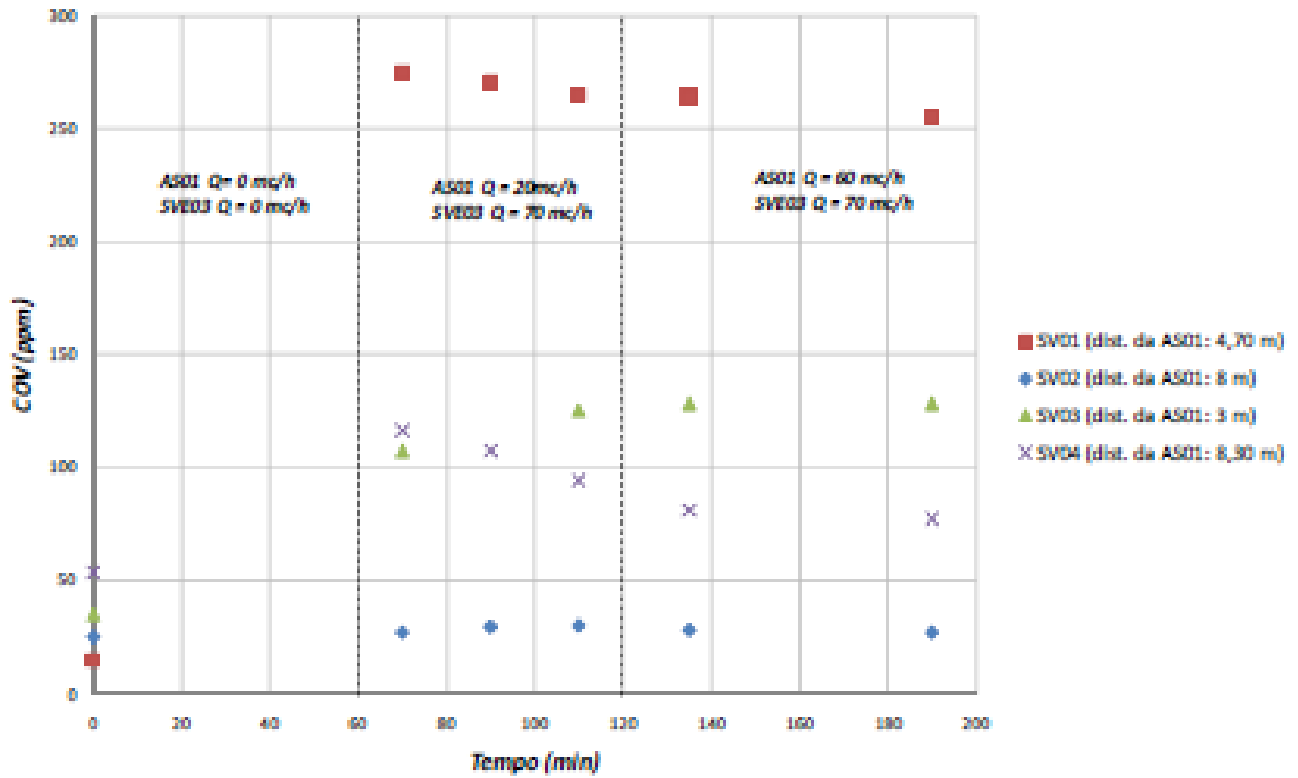

Second test results

4. Full-scale application

4.1 Extraction system

The number, spatial location, and construction characteristics of the vapour extraction points were defined in consideration of the ROI determined through the pilot tests, the areal and vertical distribution of the contamination, without neglecting the litho-stratigraphic structure of the site.

The parameters used for the dimensioning of the SVE system were chosen according to the results obtained from the pilot test; in particular, the following project parameters were assumed:

- Calculated radius of influence, ROI: 2.7 m from the vapour extraction point;
- Depression applied to each SVE point, PEa: from -10 to -20mbar;
- Extraction rate for each SVE point, QEa: about 70 Nm³/h.

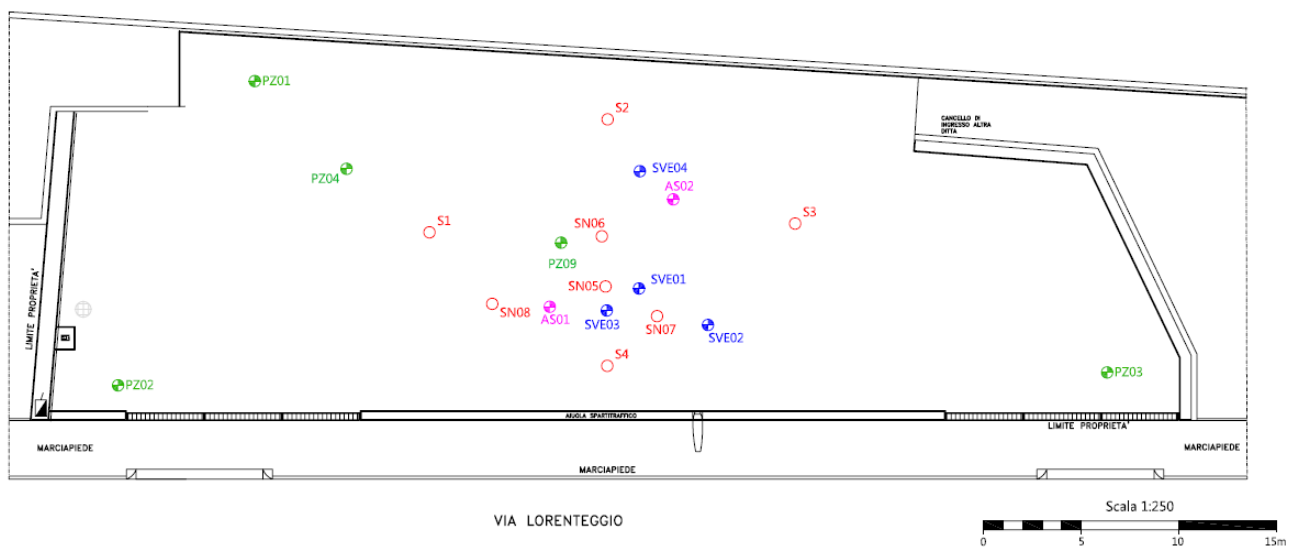

The vapour extraction system consists of 10 points, all made by means of core destruction drilling, with the housing in the sounding hole of a non-toxic PVC pipe with a diameter of 2", installed at a maximum depth of 9 m from the ground level (in particular, some SVE wells were built up to 9 m deep and with a filter section between 7 and 9 m from the local ground level; some SVE wells pushed up to 7 m deep and with a filter section between 5 and 7 m from the local ground level; some SVE wells pushed up to 4 m deep and with a filter section between 2 and 4 m from the local ground level).

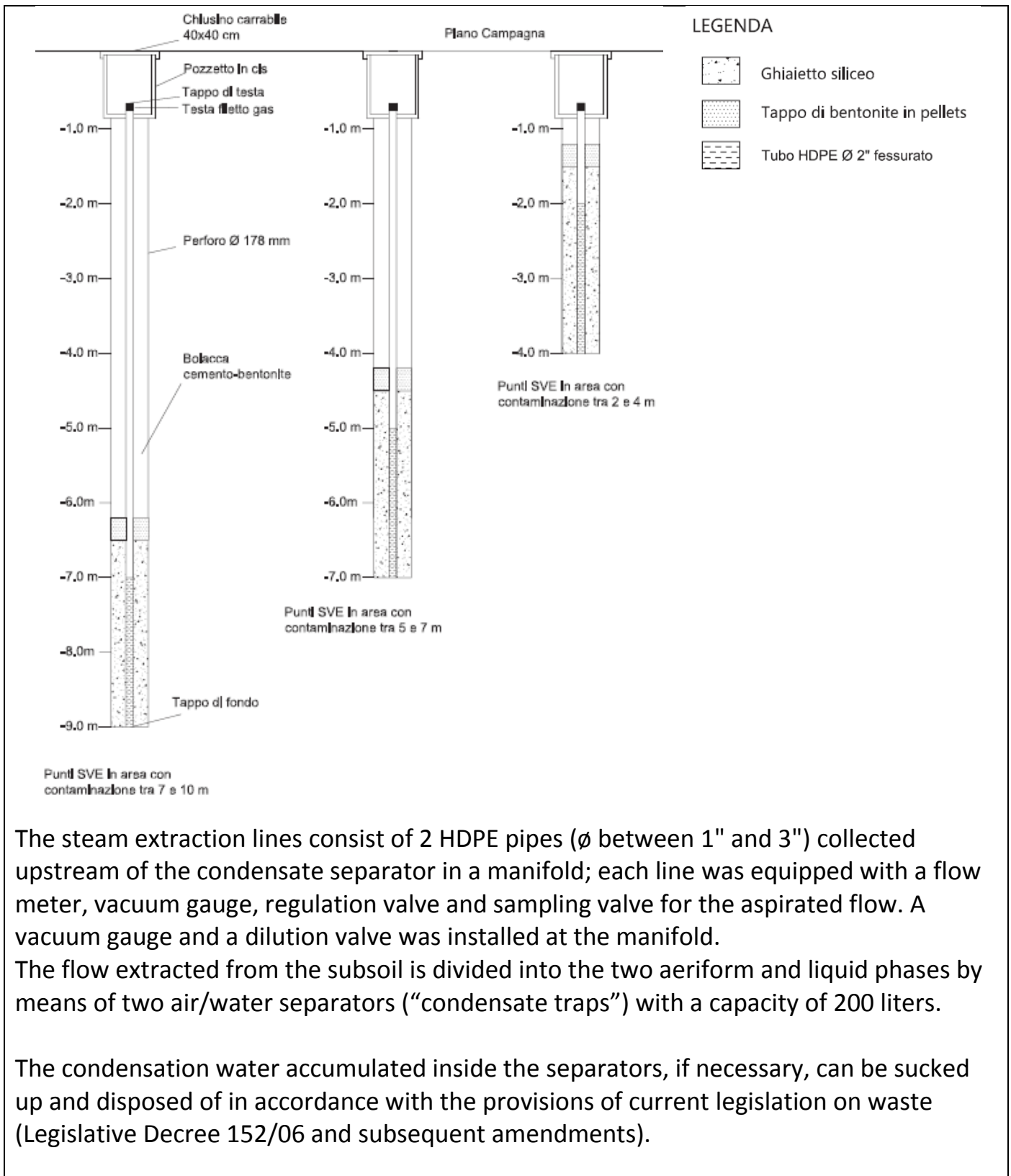

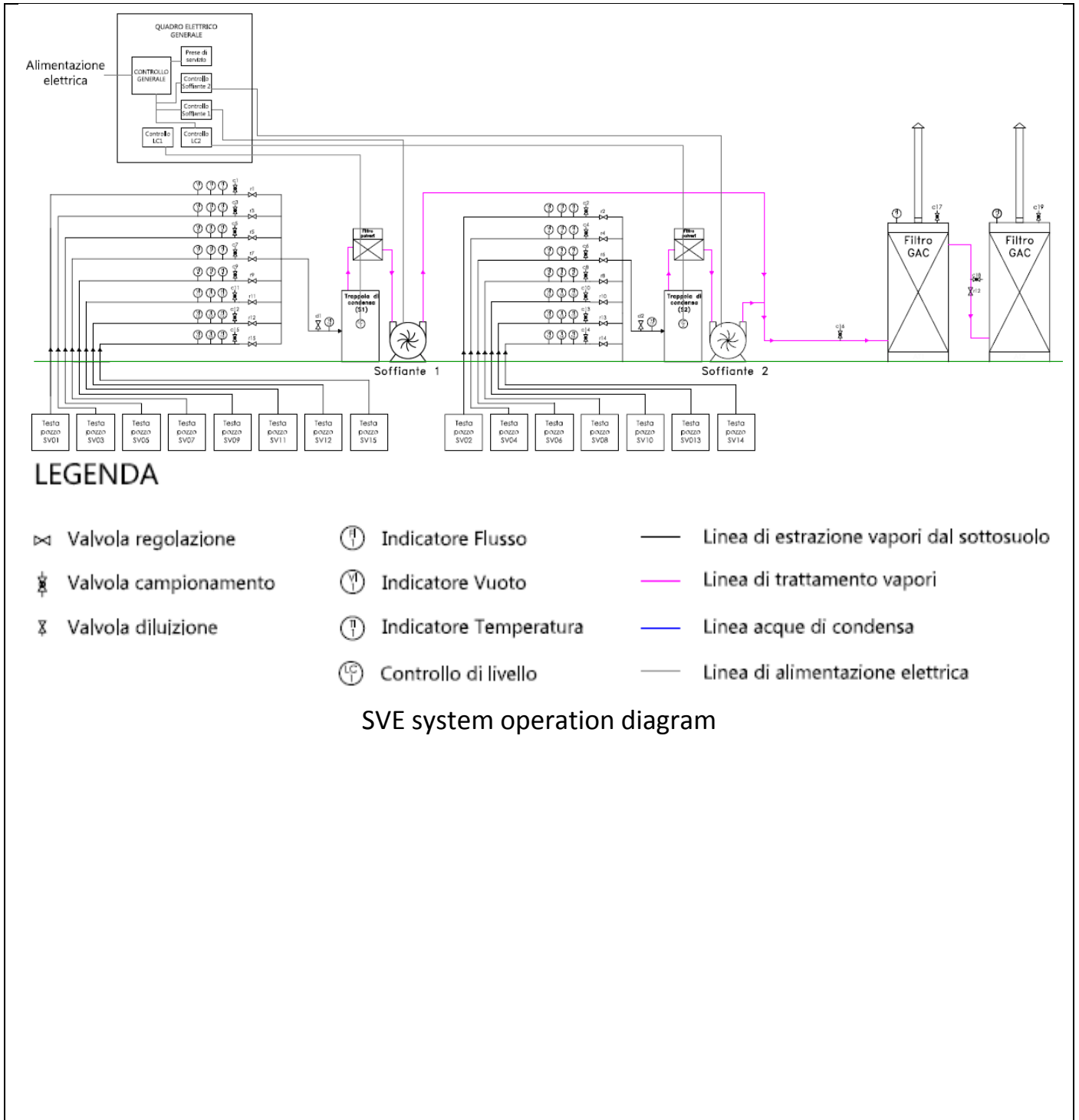

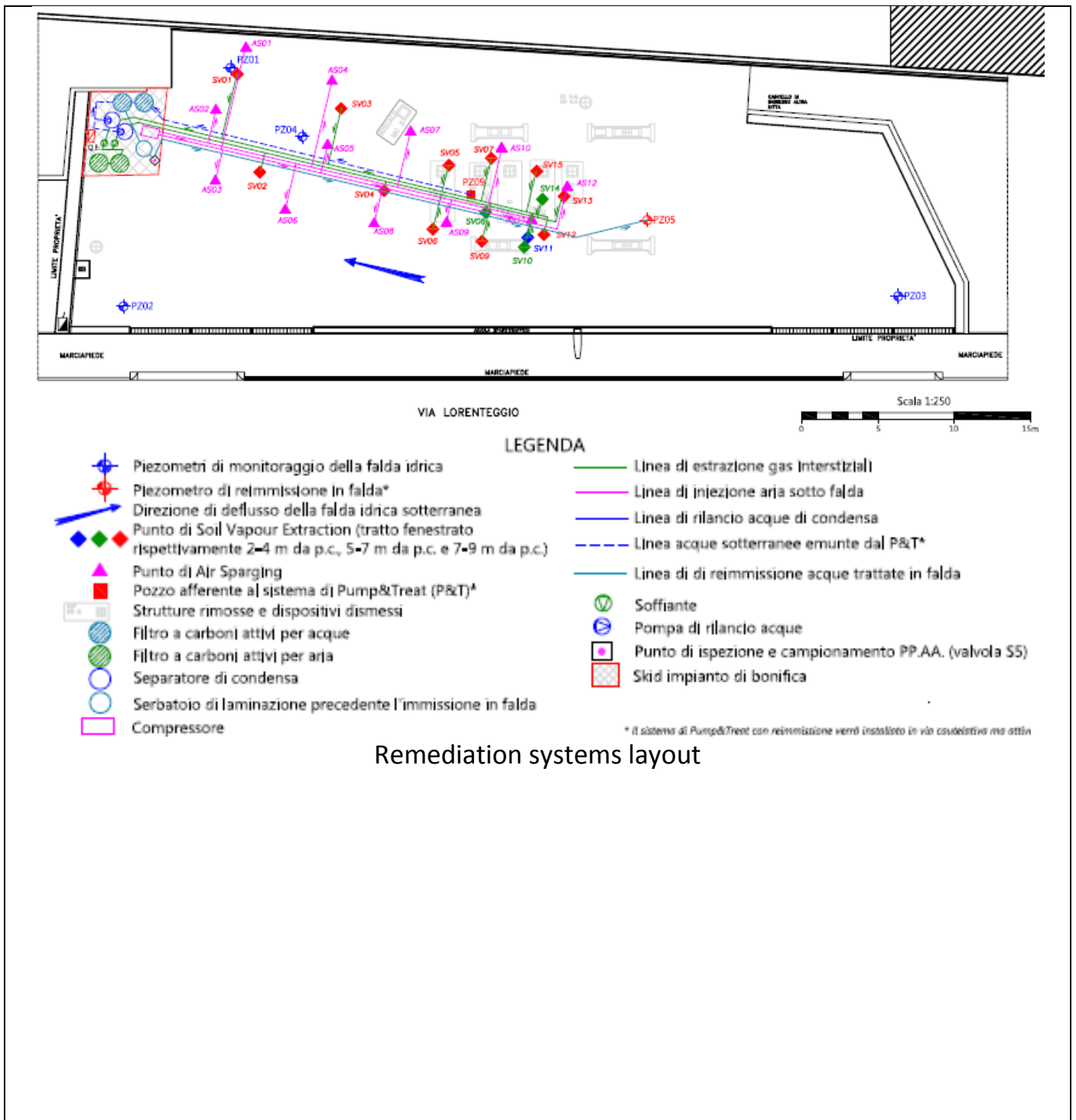

Remediation systems layout



4.2 Injection system

In the full-scale application, atmospheric air was used as a carrier gas and the system was built with the installation of n. 10 SVE wells.

The ventilation system has provided for the installation of 2 side channel blowers (regenerative blower), by means of which to induce a depression in correspondence with the vapour extraction wells created/positioned in order to treat specific portions of unsaturated subsoil, favouring the desorption of the contaminants from the solid phase to the gas phase.

The criterion underlying the design choice to use two blowers was based on the opportunity to alternate the steam extraction points on two separate lines, allowing some flexibility in managing the system and letting it operate during partial maintenance.

In particular:

- BLOWER 1 - afferent to 8 steam extraction points, capable of reaching a depression between -200/-250 mbar, for a total flow rate of approximately 560 Nm³/h, in order to guarantee an equal air flow for each extraction point at about 70 Nm³/h;
- BLOWER 2 - afferent to 7 steam extraction points, able to reach a depression between -200/-250 mbar, for a total flow rate of about 500 Nm³/h, so as to guarantee an equal air flow for each extraction point at approximately 70 Nm³/h.

The blowers, each connected to a group of suction points, work individually alternately according to on/off cycles controlled by a timer.

4.3 Radius of influence

The operating range of influence used in the project was assumed to be equal to the ROI obtained from the pilot tests, i.e. 2.7 meters for each single ventilation point.



4.4 Off gas Treatment

The vapours extracted from the subsoil have been collected and conveyed to condensate traps, where the separation between the interstitial gas and any water vapour present in the extracted air flow takes place; the condensate water is removed from the separators by means of special booster pumps and sent to a water treatment system before being discharged into the sewer system.

The interstitial vapour, once dehumidified, passes through an anti-particulate filter before passing through the blower that generated the vacuum and only then is sent to the air handling unit.

To reduce the pollutants present in the extracted interstitial gases, a pair of filters in series with granular activated carbon was installed.

The treatment unit has also been provided with arrangements that allow the filters to be arranged in parallel in the event that the inlet flow shows compatible VOC concentrations.

The exhaustion time of the activated carbons used for the treatment of interstitial gases, estimated on the basis of very conservative theoretical calculations, was set in the project as approximately 87 days and was verified with the results of the analyzes carried out on the outgoing air samples from the plant from the respective plants.

This check made it possible to program the replacement of the carbon pack of the filters according to the actual site-specific conditions.



4.5 Control parameters

To evaluate the effectiveness of the SVE intervention in the three dimensions, checks were carried out during the start-up phase of the plants and subsequently with periodic checks.

The reclamation plant and the state of the sites were periodically subject to visits aimed at:

- verify the correct functioning of the systems;
- perform routine maintenance of the system;
- schedule any extraordinary maintenance interventions;
- monitor the operating parameters of the plant and possibly remodel the adjustments;
- check the quality of the flows entering and leaving the water and air treatment system.

Before starting the plant, or at T_0 , a complete monitoring of the groundwater was carried out, with detection of the static piezometric level and measurement of the chemical/physical parameters with particular attention to dissolved oxygen values.

At the first start-up of the SVE/AS plant, the appropriate adjustments were made on the operating parameters (extracted/injected flows, pressures/depressions, etc.) and the simultaneous monitoring of the subsoil response (concentration of VOC - O_2 - CO_2 in the interstitial vapours, induced elevations in the aquifer, dissolved oxygen levels in groundwater, etc.) and the efficiency of the treatment systems.

During the setting up, the following measurements were therefore carried out every 2 days:

- relief of depressions in the vapour extraction points and on the manifold;
- survey of the VOC concentrations and the volumetric percentages of O_2 and CO_2 in the vapour extraction points;
- survey of the concentrations of VOCs entering and leaving the air treatment system;
- measurement of extracted flow and injection rates;
- pressure relief at the injection points;
- piezometric survey in correspondence with all wells/piezometers installed on-site;
- measurement of chemical-physical parameters with particular reference to dissolved oxygen (OD).



The set-up took about 10 days and ended with the testing of the air treatment system by sampling and laboratory analysis of the vapours entering and leaving the system.

The above analytical results allowed to validate the use of the portable photo ionizer (hereinafter PID) as a subsequent tool for controlling the quality of the effluent.

Check-ups were carried out on a monthly basis on the system in order to verify the correct functioning of the system and monitor the operating parameters of the system (extraction/injection flow rates, pressures/depressions, VOC - O₂ - CO₂ concentration in the interstitial vapours, OD concentration in groundwater, piezometric levels, etc.) making any new adjustments if necessary.

During operation, routine maintenance of the plant parts was performed (filter cleaning, etc.) and, if necessary, extraordinary maintenance (replacement of activated carbon, waste disposal, etc.).

On an annual basis, samples were taken from an absorber vial to be sent to the laboratory to analyze the gaseous flow in and out of the air treatment system.



6. Post treatment and/or Long Term Monitoring

6.1 Post treatment and/or Long Term Monitoring

Following the injection of atmospheric air into the saturated subsoil and the ventilation of the vadose portion, mobilization and removal of the volatile organic compounds present and oxygenation of the subsoil were obtained.

The increased availability of oxygen favours the aerobic biodegradation processes of hydrocarbons.

For this purpose, periodic respirometric test campaigns (every six months) were carried out during operation, which consists of monitoring the oxygen and carbon dioxide concentrations for a sufficiently long period of time (48 hours) after the shutdown of the systems' ventilation, in order to evaluate aerobic activity in the unsaturated subsoil.

In practice, once the system is turned off, the oxygen present in the interstitial gases will tend to be consumed more rapidly the greater the aerobic biological activity present. On the contrary, the concentrations of carbon dioxide will tend to increase more rapidly the more intense the aerobic biodegradative activity is in place.

On the basis of the data collected, it is possible to estimate average biodegradation rates of contaminants per soil mass in the unit of time.

A soil gas control network has not been envisaged on the site, whose proceedings began before the issuance of the Ministerial Decree 31/2015 and the National Guidelines (LG SNPA) on the soil gas matrix.

7. Additional information

7.2 Additional information

The project goal of the site remediation was indicated as definitively achieved when the concentrations of pollutant compounds adsorbed to the deep soil and dissolved in groundwater reach the relative CSR values set out in the following tables:

Tabella 1. Obiettivi di bonifica per suolo e sottosuolo

Sostanza indicatrice	u.m.	Obiettivi di bonifica
Piombo	mg/kg	100 ⁽¹⁾
Benzene	mg/kg	0,29 ⁽²⁾
Etilbenzene	mg/kg	0,94 ⁽²⁾
Stirene	mg/kg	0,5 ⁽¹⁾
Toluene	mg/kg	0,5 ⁽¹⁾
Xilene	mg/kg	30,24 ⁽²⁾
Sommatoria organici aromatici (da 20 a 23)	mg/kg	1 ⁽¹⁾
Idrocarburi Leggeri C ≤ 12	mg/kg	60,8 ⁽²⁾
Idrocarburi Pesanti C > 12	mg/kg	117,7 ⁽²⁾
Piombo Tetraetile	mg/kg	0,01 ⁽³⁾
MTBE	mg/kg	10 ⁽⁴⁾
ETBE	mg/kg	10 ⁽⁴⁾

(1) colonna A (siti ad uso verde pubblico, privato e residenziale) Tabella 1 dell'Allegato 5 Titolo V Parte Quarta del D.Lgs. 152/06 (CSC per i terreni)

(2) CSR approvate con Determina Dirigenziale Comune di Milano n. 596/152 del 24 novembre 2014

(3) parere ISS del 17/12/2002 n. 49759 IA.12

(4) parere ISS del 2001 n. 57058 IA/12

Tabella 2. Obiettivi di bonifica per le acque sotterranee

Sostanza indicatrice	u.m.	Obiettivi di bonifica
Benzene	µg/l	1 ⁽¹⁾
p-Xilene	µg/l	10 ⁽¹⁾
Idrocarburi Totali (espressi come n-esano)	µg/l	350 ⁽¹⁾
MTBE	µg/l	40 ⁽²⁾
ETBE	µg/l	40 ⁽²⁾

(1) CSC di cui alla Tabella 2 dell'Allegato 5 al Titolo V, Parte Quarta del D.Lgs. 152/06 come riportato nella Determina Dirigenziale Comune di Milano n. 596/152 del 24 novembre 2014

(2) Parere ISS del 12/09/2006 N. 45848, come riportato nella Determina Dirigenziale Comune di Milano n. 596/152 del 24 novembre 2014

Tabella 3. Ulteriori sostanze monitorate per le acque sotterranee

Sostanza indicatrice	u.m.	Obiettivi di bonifica
Piombo	µg/l	10 ⁽¹⁾
Etilbenzene	µg/l	50 ⁽¹⁾
Stirene	µg/l	25 ⁽¹⁾
Toluene	µg/l	15 ⁽¹⁾
Piombo tetraetile	µg/l	0,1 ⁽²⁾

(1) CSC di cui alla Tabella 2 dell'Allegato 5 al Titolo V, Parte Quarta del D.Lgs. 152/06

(2) Parere ISS 17/12/2002 n. 49759 IA.12

The project envisaged that the remediation testing would be required when, for three subsequent monitoring, compliance with the remediation objectives for groundwater determined by the Site-Specific Risk Analysis and Compliance (CSC) was found at the PoC and at the same time the SVE plant had extracted zero VOC concentrations for a period of at least 3 months.

Upon verification of the above conditions, 3 monthly on/off cycles of the groundwater reclamation and sampling plants were carried out.

Following the positive outcome of the three monitoring sessions carried out in the shutdown cycles, the shutdown of the plants and the subsequent testing of the deep soil matrix was envisaged. It was proposed to carry out some probes with sampling of unsaturated matrix for verification of compliance with the CSRs defined by the risk analysis.

From the end of June 2018 to the end of July 2018, when the remediation systems were shut down, the SVE plant extracted an average flow rate of interstitial gases from the subsoil equal to about 12,000 m³/day.

In the same period, the AS plant, by means of a side-channel compressor, had blown atmospheric air into the saturated subsoil with an operating pressure of about 0.3 bar and an average flow rate of 240 m³/h.

From August to October 2018, the SVE and AS plants operated intermittently to allow the implementation of the reclamation test plan.

The duration of the reclamation of the subsoil was estimated at about 3 years, with the start-up of the plants on 27 July 2015. The operation of the reclamation plants ended in July 2018.

In the subsequent period up to January 2019, the testing activities of the environmental matrices of the subsoil were carried out. These showed compliance with the remediation objectives for groundwater and unsaturated soils in the south-east sector of the site, with the exception of the area central of the site where residual



concentrations of heavy hydrocarbons C> 12 persisted.

The checks carried out on the groundwater matrix, on the other hand, showed compliance with the CSCs of reference to the POC of the site (this situation was verified over time through the monitoring of the groundwater).

The outcome of the testing on unsaturated soil, implemented as per the approved test plan, therefore highlighted the persistence of values exceeding the established remediation objectives.

The analyses carried out by the ARPA Laboratory, on the samples taken in contradiction, show the failure to achieve the remediation objectives for the hydrocarbon parameter C> 12 in a sample taken in the depth range between 5 and 6 m from the local p.c. (the ARPA Laboratory quantifies a value of 458 mg/kg dry matter, compared to the remediation target set at 117.7 mg/kg, as defined by the reference CSR).

Similarly, the Party's data shows the non-compliance with the remediation objectives for the hydrocarbon parameter C> 12 only in two samples taken both in the same vertical survey verified by ARPA, one between 3 and 4 m deep from the local p.c. (with 880 mg/kg, compared to the CSR of 117.7 mg/kg) and one between 5 and 6 m of depth from the local p.c. (with 300 mg/kg, compared to the CSR of 117.7 mg/kg).

The checks were carried out after the period of operation of the reclamation plant in unsaturated soil. The south-east sector of the former PV shows the achievement of concentrations lower than the reclamation objectives, while in the center of the site, residual concentrations were determined in Heavy hydrocarbons C> 12 exceeding the CSR, distributed between the depths of 3 and 7.5 m from p.c..

The almost zero values of the VOCs measured in the interstitial gases extracted from the unsaturated subsoil with the SVE plant and the weak biodegradative activity determined with the respirometric test showed that the remediation systems, consisting of an SVE, AS and P&T plant, have exhausted their effectiveness in cleaning up contamination.

Faced with this evidence, it was proposed to launch a soil gas monitoring campaign on the site to measure the real flow of volatile substances present in the subsoil in order to apply the measured data as part of a risk analysis review.

For the verification of the real flow coming from the subsoil it was initially proposed to use some of the existing SVE wells for the soil gas monitoring network. In view of the observations made by ARPA (which assessed the dimensions and depths of the filtering sections of the proposed SVE wells as non-compliant with the specifications of the LG SNPA), the installation of 3 soil gas probes of the "nesty probe" was therefore proposed. The monitoring activities of the soil gas matrix, which will be carried out for an annual duration with seasonal campaigns (quarterly sampling), will be used to obtain direct data to be used for a review of the risk analysis.

1. Contact details - CASE STUDY: SVE n.17

1.1 Name and Surname	Confalonieri Massimiliano, Panzeri Paola, Canepa Paola
1.2 Country/Jurisdiction	Italy
1.3 Organisation	ARPA Lombardia
1.4 Position	Dirigente RUO BARAE
1.5 Duties	
1.6 Email address	m.confalonieri@arpalombardia.it
1.7 Phone number	+39 335 531 8045

2. Site background

2.1 History of the site

The site covered by this questionnaire is known as EX BRENNTAG DEPOSITO and is located in an industrial area north-west of Milan, in the municipality of Bollate.

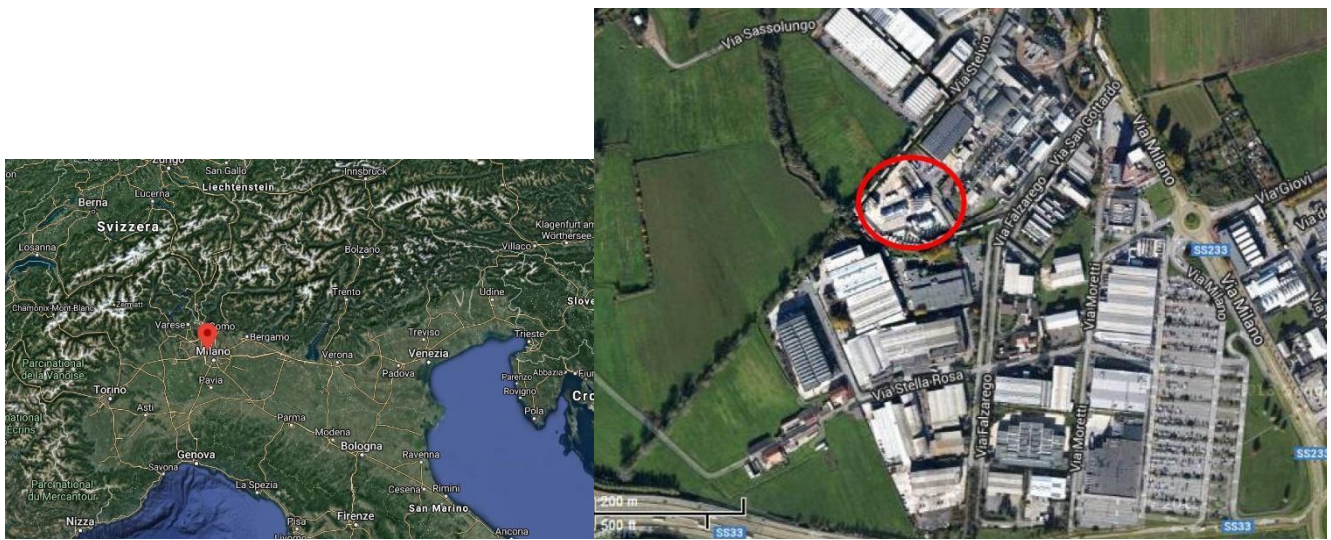

The area is not part of a Site of National Interest.

The company, active since the late 1950s, deals with the storage and distribution, wholesale and retail, of chemical substances and is one of the Industries at Risk of Major Accident subject to Legislative Decree no. 105/2015 called "Seveso III Decree".

The deposit initially covered only a limited part of the current surface and consisted of 10 vertical 30 m³ above ground tanks, located along the southern border, and 11 (plus 5 installed after a few years) buried tanks of 30 m³ each. (some of which divided into two compartments), arranged along the western border; all these tanks have now been removed and demolished. From notes of the time, it seems that the products stored were the following:

- Underground tanks: dichloroethane, MEK, Acetone, Ethyl alcohol, Methyl alcohol, Isobutyl acetate, Ethyl acetate, IPA, Heptane, Octane, Toluene, Hexane, Cyclohexane, Trieline, Tetrachloroethane, Sulphuric ether, Solvent naphtha from petroleum, THF, MIBK
- Above Ground Tanks: Ethyl glycol, Butyl glycol, Ethylene Glycol, Propylene Glycol, Propylene Glycol USP, Methyl glycol, Methyl glycol Acetate, Cyclohexanone and Cyclohexanol

The deposit has undergone various modifications over the years; was expanded in 1968

(10 tanks of 50 m³ above ground), in 1974 (25 tanks of 50 m³ underground) and in 1985 (7 tanks of 50 m³ above ground, 6 horizontal tanks of 50 m³ above ground (subsequently demolished) and 1 tank of 100 m³ horizontal above ground) when it has reached the maximum storage capacity.

Over time, phthalates, n-paraffins, dichloropropane and various types of esters have been added to the products mentioned. In the mid-1990s, however, chlorinated products were eliminated, with the exception of dichloropropane, which was eliminated at a later time.

It should be noted that in the mid-1990s some above ground tanks located along the border of the site with the Guisa stream were removed and in 1998 the underground tanks arranged along via San Gottardo, to the left of the entrance to the industrial area, were removed.





2.2 Geological setting

The area under study is located in the central sector of the Milanese mid-plain and is characterized by a sub-flat morphology, with topographic altitudes degrading towards the South, linked to fluvio-glacial and fluvial deposition of the Quaternary age. The morphological structure of the territory consists of extensive fluvio-glacial plains. To the south of the industrial site, the Guisa stream flows eastwards. The site consists of Postglacial Unity (Upper Pleistocene - Holocene), consisting of fluvial deposits with no alteration profile and poorly developed soil, less than one meter thick. From a lithological point of view, the deposits are generally made up of slightly silty sands, with interspersed gravels with a clastic support or a sandy matrix, generally loose.

In the area under examination, the hydrogeological units follow one another, from the most superficial to the deepest, according to the following scheme:

Aquifer Group A: consisting of deposits in high-energy braided fluvial facies. Lithologically it is mainly composed of coarse gravelly-sandy sediments with a medium-coarse sandy matrix with subordinate sandy intervals from medium to very coarse, with high porosity and permeability; locally there are decimetric levels of clay and silty clays and horizons consisting of cemented and conglomerate gravels. The thickness varies from a minimum of 26-30 m up to a maximum of 40-45 m and its lower limit is placed in correspondence with the first truly continuous clayey levels;

Aquifer Group B: consisting of deposits in braided fluvial facies. Lithologically it is mainly composed of coarse sediments represented by medium-coarse sands, pebbly sands and gravels with a sandy matrix with high porosity and permeability; downwards the granulometry of the sediments decreases and the cemented horizons (sandstones and conglomerates) and the levels of fine clayey-silty sediments become more frequent. The overall thickness is around 45 m on average with minimum values around 35 m and maximum values of 55 m.

Aquifer Group C: consisting of deposits in continental/delta transitional facies. Lithologically it consists of fine to medium sands and silty clays with peaty horizons interspersed with gravel-sandy levels with greater permeability. The overall thickness is unknown as the lower limit was not reached by the drilling of the deepest wells in the area. In the permeable levels there are intermediate and deep aquifers, of the confined type, whose vulnerability is mitigated by the presence of continuous clayey layers on the roof, but connections and feeding by the highly vulnerable upper free aquifer cannot be excluded.

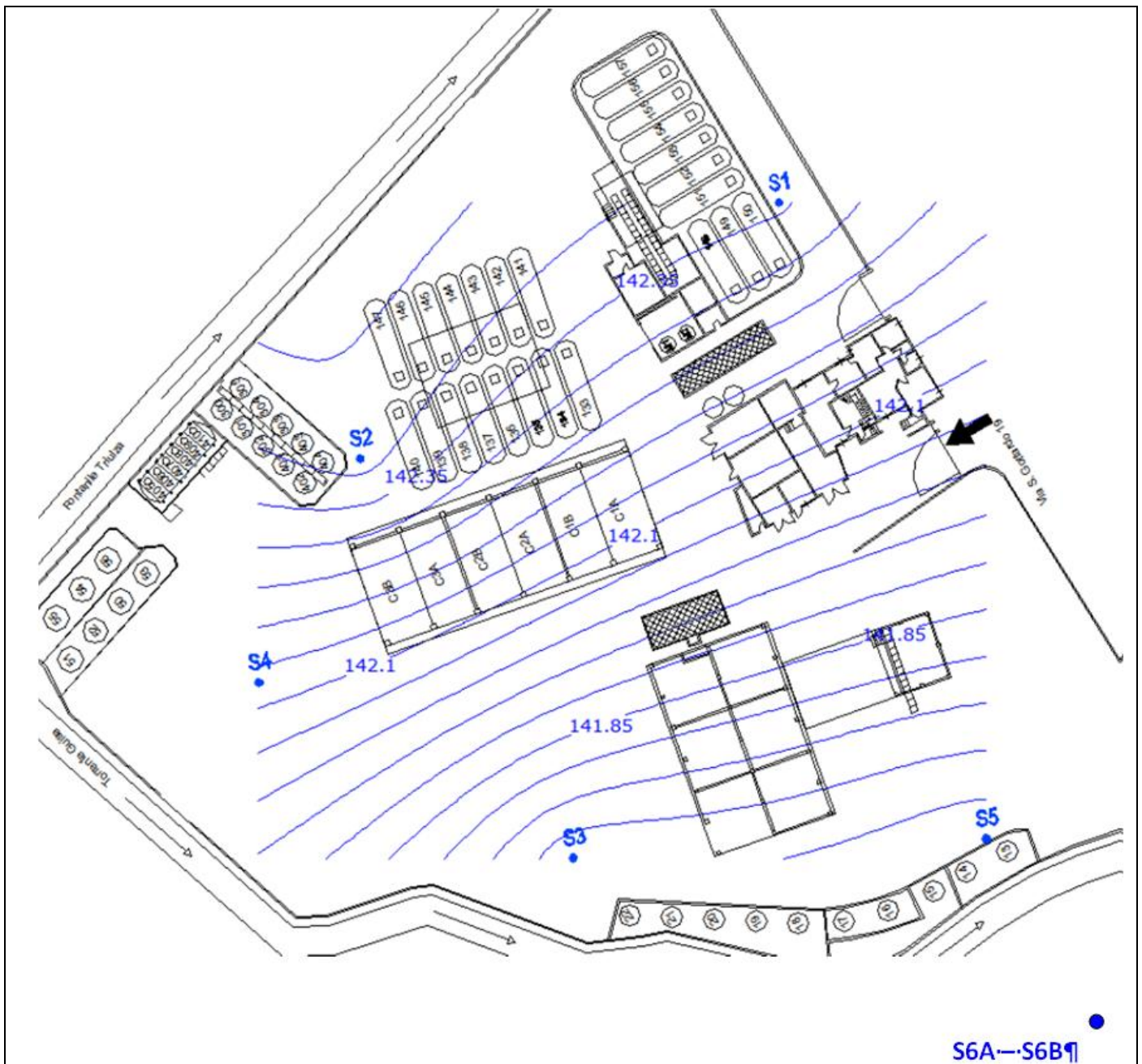

The aquifer groups A and B described above are the seat of the main free-type or locally semi-confined aquifer, characterized by subsidence around 20-30 m from the ground level, traditionally captured by the collection wells for drinking water purposes of old construction and from private wells (information taken from the document "Componente geologica, idrogeologica e sismica del Piano di Governo del Territorio" of the Municipality of Bollate, drawn up in 2010 by the "Studio Idrogeotecnico").

Specifically, in the area in question, it is possible to identify 2 distinct layers, separated from each other by a clay lens placed at a depth of 20 m; the static level of the surface



aquifer is around 8 m deep.

The image above shows the isopiezometric map drawn up in 2014 (the static levels were measured on 28/02/2014) for the additions to the site characterization plan; we deduce that the direction of the water table is NNE-SSW, with a gradient of about 1.6 ‰. The figure shows the 7 piezometers that make up the monitoring network and which were grounded in 1994.

The characteristics of the monitoring points are summarized below:

ID	Diameter - inches	Depth - m	volumetric flow (19/03/2014) - l/s
S1	4"	20	
S2	4"	15	0.5
S3	4"	20	0.2
S4	4"	18.5	
S5	4"	18	0.4
S6A	2"	20	
S6B	2"	38	

The S2, S3 and S5 piezometers are equipped with submersible pumps for the continuous pumping of water; these piezometers are part of the Pump and Treat (P&T) system which has been active since 21/09/1994. The plant consists of:

- a 30 m³ tank for the collection and homogenization of the water extracted from the reclamation wells;
- a stripping tower for water purification;
- two activated carbon filters, with 80 kg carbon load, positioned in series, for the treatment of gases coming from the stripping tower;
- two activated carbon filters (4,000 kg + 1,000 kg approx.) for the treatment of wastewater leaving the stripping tower;
- a sand filter (approx. 1,000 l) to protect the activated carbon filter for water treatment.

The plant is also designed for the collection and purification of rainwater.

The treated water is discharged into the Guisa stream, which flows immediately downstream of the area.

2.3 Contaminants of concern

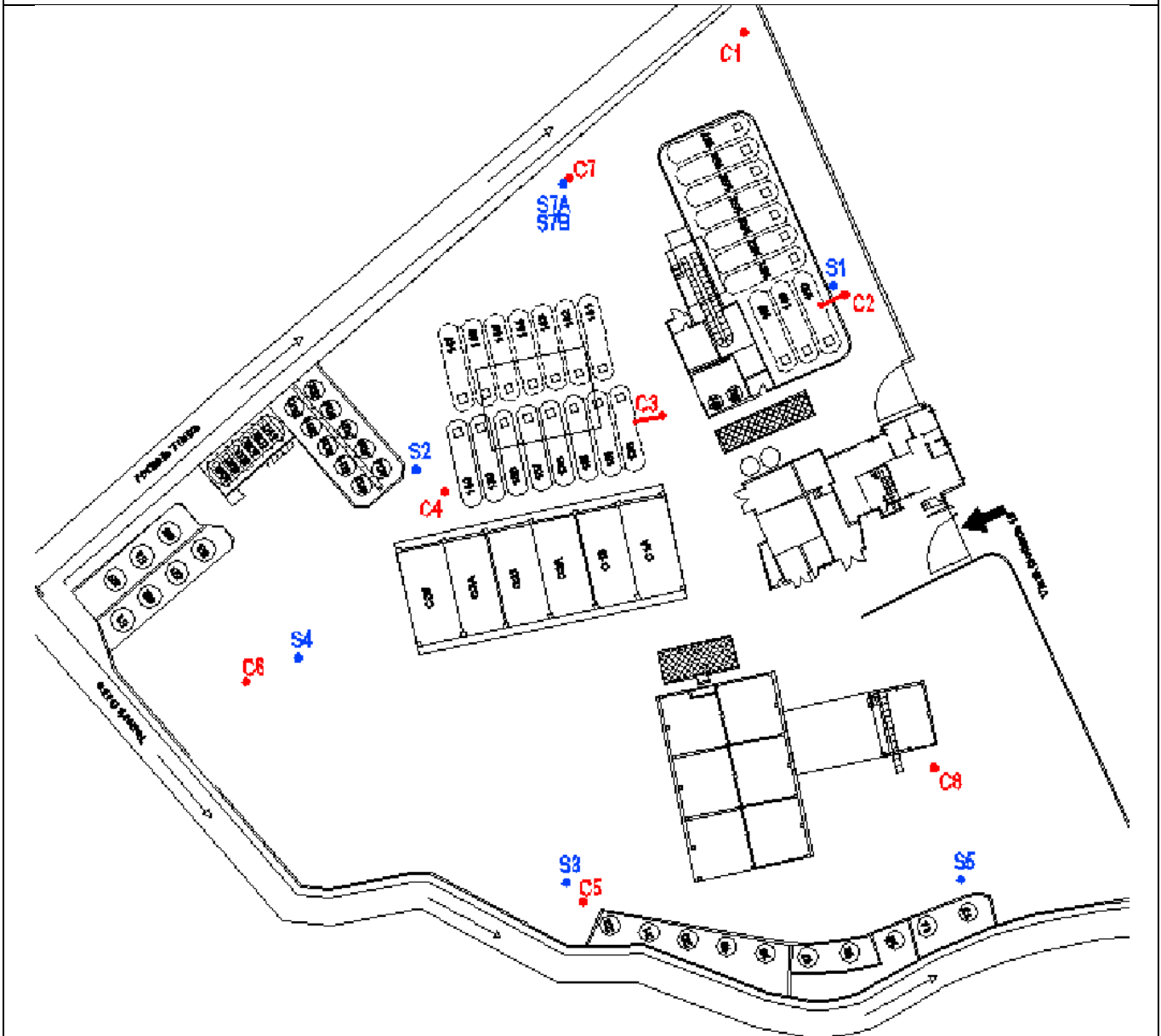

The site is characterized by contamination by chlorinated solvents, affecting both the land and the groundwater. The following figure shows the location of the surveys carried out (in red) for the characterization of the land and the location of the piezometers making up the groundwater monitoring network underlying the site (in blue). During the characterization activities, two additional piezometers, 2" each, respectively about 20 m deep (identification code S7A) and 40 m (identification code S7B) were installed with the aim of creating a monitoring point of the surface water



table (S7A, to be compared with S6A) and a monitoring point of the deeper aquifer (S7B, to be compared with S6B). Each bore reached a depth of about 6 m from ground level and for each of them 3 soil samples were taken, one of superficial soil (between 0 and 1 m from b.c.), one intermediate and one in the last meter of the survey.

The analysis on the soil samples taken showed a contamination in correspondence of the C8 survey, both for the superficial and deep soil:

- surface soil (sample taken between 0.2 and 1 m from bw): Hydrocarbons C <12, Benzene and Tetrachlorethylene
- deep soil (sample taken between 2.3 and 2.7 m from b.c.): Trichloromethane and Trichlorethylene.

The maximum concentrations measured (taken from the Operational Remediation Plan, presented in December 2015) are shown in the following table.

Contaminants	Maximum concentrations (mg/kg)
Hydrocarbons C <12	2,120
Benzene	4.11
Tetrachlorethylene	50.7
Trichloromethane	10,536
Trichlorethylene	26,076

It has been estimated that the contamination affects an area of about 200 m², located at a depth of 5 m, for a volume of about 1000 m³.

As regards groundwater, both the most superficial and the deepest aquifers present contamination by chlorinated solvents, but with significant differences in the concentrations of PCE (main contaminant) which are lower in the deeper aquifer where the concentration could also be linked, in part, to an upgradient contribution.

2.4 Regulatory framework

The reference limits considered are those contained in Legislative Decree 152/06, Tab. 1, Col. B (intended industrial use).



3. Pilot-scale application in field

3.1 Extraction system

In the area reclamation project and related additions, the construction of an SVE (Soil Vapor Extraction) treatment plant was proposed, in the area around survey C8, characterized by the presence of soils contaminated mainly by chlorinated solvents. In the Reclamation Project it was proposed to combine the SVE also with an AR (Air Sparging) treatment for groundwater. It should be emphasized that on the site, as reported above, an operational safety system is already in operation consisting of 3 points of extraction of the groundwater, which are then sent to a treatment plant. This system will remain in operation also during the SVE/AS treatment.

Between 9 and 10 November 2016, the drillings were carried out for the preparation of the test field for the pilot test, which was carried out between 14 and 16 November. During the execution of the test the first SVE point made (later called SVEold) showed problems and, consequently, on 2/12/2016 a second SVE point was made to replace it. On 11/01/2017 the pilot test on the new point was repeated.

The technical-constructive characteristics of the survey points making up the test field are summarized in the following table:

Point	well	Diameter	Depth (m)	Screen (m)
SVE and SVE old	40X40	3"	4	1-4
SGS1	30X30	6 mm (rilsan)	1.5	1.2-1.5
SGS2	30X30	6 mm (rilsan)	1.5	1.2-1.5
SGS3	30X30	6 mm (rilsan)	1.5	1.2-1.5

The SVE point represents the aspiration point for the Soil Vapor Extraction (SVE) test and the SGS points were used as soil gas monitoring during the SVE tests.

The following figure shows the location of the survey points of the test field. In the image, the AS point is also indicated, which represents the air blowing point for the Air Sparging test (AS) and the MAS points, used as groundwater monitoring during the AS tests.

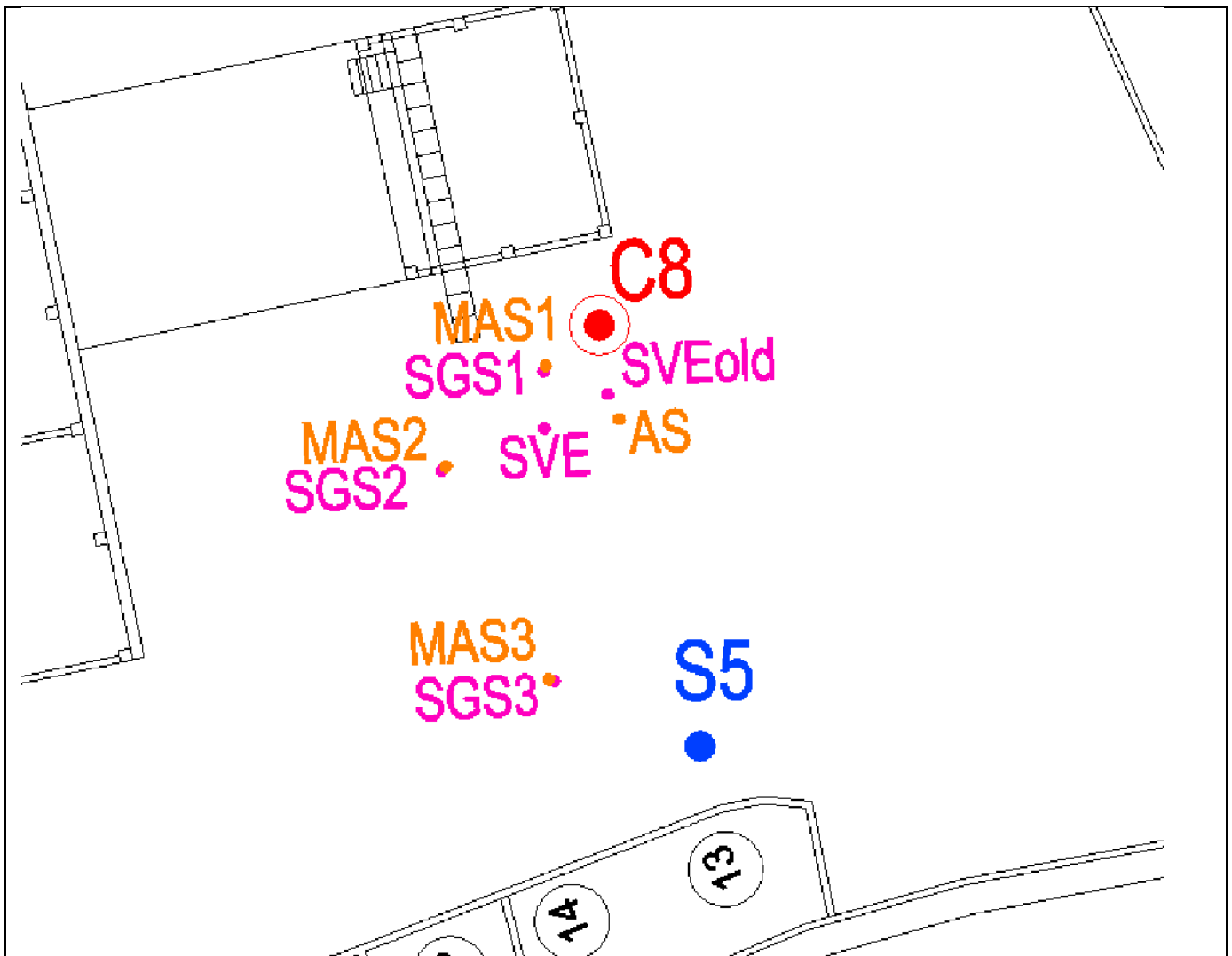

The following table shows the stratigraphy of the SVE point.

Depth (cm from ground level)	Description
0-30	Concrete slab
30-180	Filling consisting of slightly silty sands and gravels with some brick, brown color
180-300	Coarse sands and gravel with pebbles, gray/black color
300-400	Coarse sands and gravels, ocher color

The pilot test on the new SVE point was carried out on 11/01/2017.

The pilot tests were carried out by installing, at the SVE point (see image below), an aspiration system equipped with an activated carbon filter consisting of a rotary blower, regulation valves and vacuum-tight pipes.



The pilot test was performed by sucking air from the SVE point and monitoring, with field instruments, the following parameters:

- VOC (volatile organic compounds) of interstitial gases with the use of a Portable Photoionizer (PID);
- concentrations of oxygen, carbon dioxide, Lel (Lower Explosive Limit) of interstitial gases with a portable IR instrument;
- depressions induced by the rotary blower with a digital pressure gauge (thermo anemometer).

The parameters were measured at the monitoring points arranged around the suction point at distances varying between about 2 m and 8 m from the central point; the following table shows the name of the monitored points and the distance from the SVE point:



Monitoring point	Distance from SVE (m)
SVEold	2.4
SGS1	1.9
SGS2	3.7
SGS3	8.4

The SGS points intercept the horizon between 1.2 and 1.5 m from ground level.

The SVEold point has filters between 1 and 4 m.

First of all, a rapid flow step test was performed, increasing the pump flow in order to identify the flow rate to be used in the constant flow test. The constant flow test was then carried out and lasted for 5 hours, in order to verify the trend of the parameters in the subsoil, following the activation of an SVE system. The rotary pump was set at an average flow rate of 47 mc/h.

The parameters measured at the extraction point and at the monitoring points are summarized in the following tables.

SVE								
Tempo	Pid	Lel	O2	CO2	Depress	V	T	Q
minuti	ppm	%	%	%	mbar	m/s	°C	mc/h
0	480.1	18	21.3	1.22	-286.0	7.74	1.4	47
10	2147.0	16	21.5	3.45	-258.0	6.57	0.8	47
30	2371.0	13	20.9	3.16	-249.0	6.23	4	43
60	4106.0	13	20.9	2.7	-236.0	6.77	4.1	50
90	4469.0	10	20.9	2.26	-232.0	7.46	4.6	53
120	5000.0	10	20.9	2.08	-229.0	8.27	5.2	57
180	5000.0	9	20.9	1.83	-225.0	9.03	5.9	64
240	5000.0	9	20.9	1.62	-222.0	9.53	6.9	67
300	5000.0	8	20.9	1.44	-220.0	9.6	7	72

SVE old						SGS1					
Tempo	Pid	Lel	O2	CO2	Depress	Tempo	Pid	Lel	O2	CO2	Depress
minuti	ppm	%	%	%	mbar	minuti	ppm	%	%	%	mbar
0	1824.0	47	21.3	4.99	0.0	0	544.3	0	21.3	4.99	-5.8
10	1867.0	40	21.5	4.99	0.0	10	261.1	5	21.5	4.99	-6.5
30	2042.0	27	20.9	4.39	0.0	30	61.3	2	20.9	0.07	-7.0
60	2015.0	27	20.9	3.81	-0.9	60	266.0	0	20.9	0.07	-7.5
90	1140.0	2	20.9	0.04	-7.5	90	125.5	4	20.9	2.05	-8.5
120	285.9	2	20.9	0.07	-15.0	120	93.2	0	20.9	1.62	-9.5
180	211.6	0	20.9	0.04	-20.0	180	88.5	0	20.9	1.65	-9.5
240	112.7	0	20.9	0.04	-22.0	240	73.2	0	20.9	1.11	-10.0
300	93.6	0	20.9	0.07	-24.0	300	73.8	0	20.9	1.25	-10.0



SGS2						SGS3					
Tempo	Pid	Lel	O2	CO2	Depress	Tempo	Pid	Lel	O2	CO2	Depress
minuti	ppm	%	%	%	mbar	minuti	ppm	%	%	%	mbar
0	1872.0	14	21.3	4.99	-6.6	0	4852.0	9	21.3	0	0.0
10	2492.0	20	21.5	11	-16.0	10	5000.0	5	21.5	0	0.0
30	2030.0	16	20.9	4.82	-22.0	30	3866.0	4	20.9	0	0.0
60	2550.0	14	20.9	4.53	-36.0	60	4670.0	5	20.9	0.04	0.0
90	2903.0	11	20.9	4.1	-38.0	90	5000.0	4	20.9	0	0.0
120		10	20.9	3.67	-39.0	120	5000.0	4	20.9	0	0.0
180					-41.0	180	5000.0	0	20.9	0	0.0
240					-43.0	240	5000.0	0	20.9	0	0.0
300					-45.0	300	5000.0	0	20.9	0	0.0

The missing data are due to the presence of condensation in the pipes that did not allow the use of the instrumentation.

Data analysis:

- the Pid highlights the increase in values at the SVE point and the simultaneous decrease in the monitoring points, in accordance with the recall of contaminants at the suction point;
- the Lel decreases in all points;
- oxygen stabilizes at 20.9%;
- carbon dioxide shows a tendency to decrease over time;
- the depressions show a greater response to pumping in SGS2 than in SGS1, closer to the SVE point, probably due to the conformation of the subsoil in the area in question; in point SGS3 there are no effects induced by pumping.

During the test, due to local conditions, the extracted flow rate varied from 47 mc/h (set at the beginning) to approximately 70 mc/h. With this capacity, considering what is highlighted by the data, the effects of the vacuum induced by pumping can be observed in the control points SVEold, SGS1 and SGS2 while the point SGS3 does not show variations. The range of influence, therefore, is between 4 and 8 m.

3.3 Radius of influence

During the pilot test, performed by sucking air from the central point called SVE, the induced depressions in the monitoring points, called SVEold, SGS1, SGS2 and SGS3, were measured and arranged as illustrated in par. 3.1. The effects of the vacuum induced by pumping are observable in the control points SVEold, SGS1 and SGS2 while the point SGS3 shows no variation. The range of influence, therefore, is between 4 and 8 m.



3.4 Off gas Treatment

In the SVE point, an extraction system with an activated carbon filter was installed.

3.5 Control parameters

During the pilot test, as reported above, the following parameters were monitored with field instruments:

- VOC (volatile organic compounds) of interstitial gases with the use of a Portable Photo ionizer (PID);
- concentrations of oxygen, carbon dioxide, LEL (Lower Explosive Limit) of interstitial gases with a portable IR instrument;
- depressions induced by the rotary blower with a digital pressure gauge (thermo anemometer).

The recorded data made it possible to identify the air permeability of the soil and the range of influence of the suction system sized for a suction point.

4. Full-scale application

4.1 Extraction system

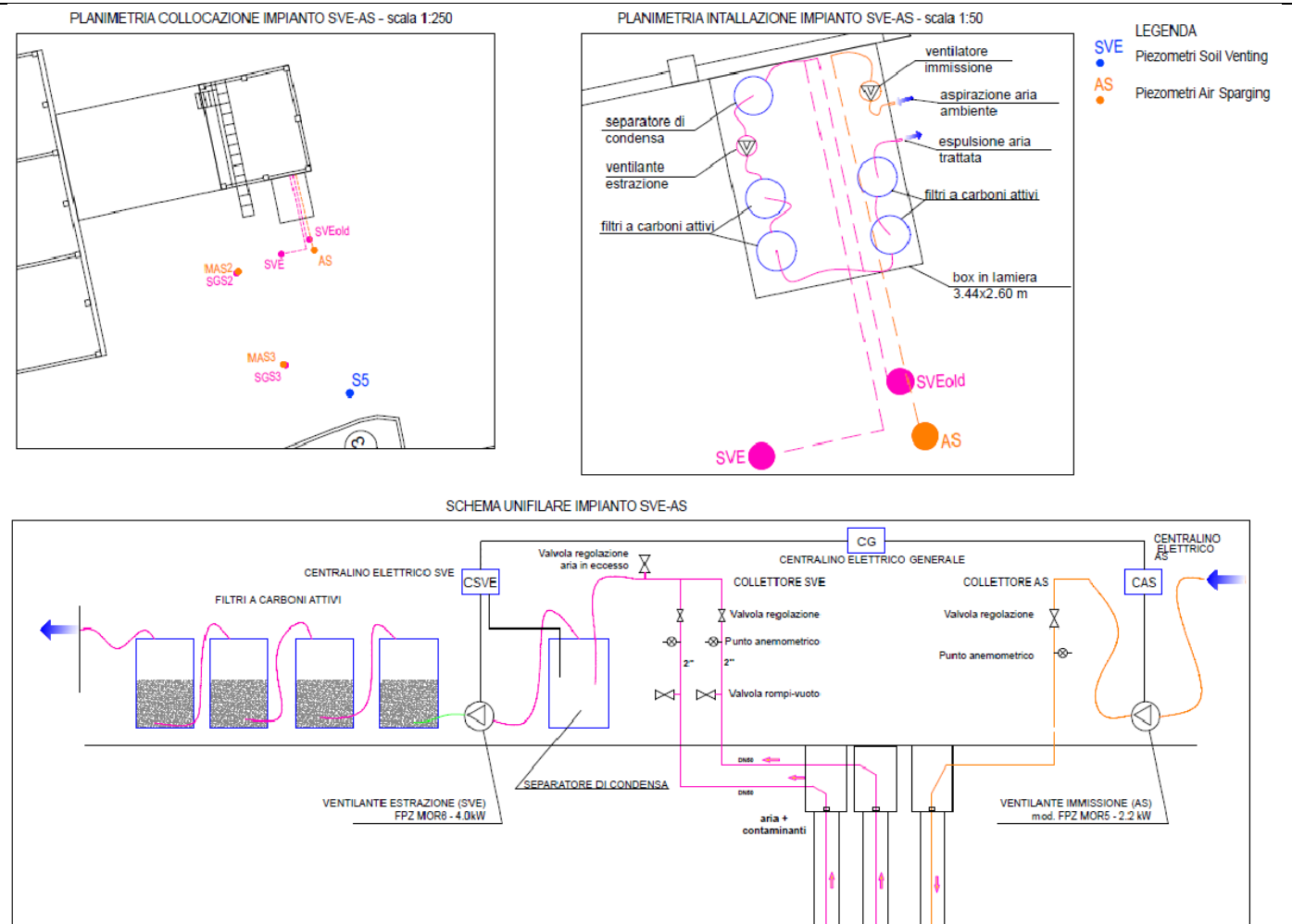

The plant and its monitoring were started on 14/03/2019.

On the basis of the pilot test performed, it was assumed, as a precaution, a range of action equal to 4 m for the SVE point; consequently it was decided to equip two points for the extraction of vapours, namely the point called SVE and the point called SVEold. During the work, specific calibration tests will be conducted in order to set the optimal configuration for the system.

The SVE and SVEold extraction wells made have the following characteristics:

- drilling up to 4 m deep;
- installation of piezometer (diameter 3"), depth 4 m, fenestrated between -1 and -4 m from the ground floor;
- cementation from p.c. at -1 m;



- installation of calibrated siliceous gravel from –1 m to –4 m from p.c.

The wellhead of the vertical intake is connected to the manifold, mounted at the plant box, which is connected to the separator and subsequently to the aspirator and filter (see image below, which also indicates the Air Sparging system).

4.3 Radius of influence

Based on the monitoring of the lowering measured during the pilot test at the control points (SVEold, SGS1, SGS2 and SGS3) the influence range is between 4 and 8 m; consequently, as a precaution, a radius of influence equal to 4 m was considered.

4.4 Off gas Treatment

Activated carbon filter

Downstream of the suction system, two containers of activated carbon weighing about 50 kg each were placed in series.

4.5 Control parameters

In order to monitor the effectiveness of the SVE/AS system, periodic monitoring of the system and sampling of interstitial gases has been prepared.

With regard to the monitoring of the plant, a fortnightly frequency of checks has been established during the first 2 months of activity, monthly up to 6 months, and quarterly up to 12 months of plant activity. During the checks, measurements of the main flow parameters of the system are carried out with field instruments capable of determining air flow (anemometer), temperature, VOC concentration (PID), differential pressure between the fixed probes in the ground and the atmosphere (Magnehelic).

Samplings of soil gases by means of activated carbon vials were also provided. On 14/03/2019 "zero" sampling took place, coinciding with the start-up of the plant. A further 4 samplings were scheduled during the 12 months of reclamation, foreseen by the project.



5. Enhancements to SVE

5.1 Pneumatic and/or hydraulic fracturing

As mentioned above, an AS (Air Sparging) plant was associated with the SVE for the treatment of groundwater underlying the site. The plant consists of a piezometer, for the injection of atmospheric air into the groundwater, with a depth of 9 m. Three piezometers (called MAS1, MAS2 and MAS3) were also created at a distance of 3, 6 and 9 m from the first one for the introduction of air, as monitoring points. The latter were carried out at the points provided for the monitoring of soil gases (SGS), within the same drilling, in such a way as to optimize economies.

6. Post treatment and/or Long Term Monitoring

6.1 Post treatment and/or Long Term Monitoring

The monitoring plan provided for a sampling of soil gases upon activation of the plant and 4 samplings during the remediation. For the sampling of soil gases, activated carbon vials are used for the determination of C <12 hydrocarbons, with relative speciation, Benzene, Tetrachlorethylene, Trichloromethane and Trichloroethylene.



7. Additional information

7.2 Additional information

Initially, it was planned to carry out a test through soil sampling, after 12 months of treatment, to verify the state of contamination and evaluate any further actions. To date, the treatment of the land is still ongoing, since, following a failure of the plant which occurred in 2020, it was decided to extend the treatment for a further year. At the time of testing, soil samples must be taken from two cores carried out near point C8, at depths of 0-1 m and 2-3 m. The analytical set must include:
Sample 0-1 m: C <12 hydrocarbons, with relative speciation, Benzene, Tetrachlorethylene
Sample 2-3 m: Trichloromethane, Trichloroethylene.

Glossary of Terms

Term (alphabetical order)	Definition
SIN	Contaminated site of national priority list
PA	public administration

1. Contact details - CASE STUDY: SVE n.18

1.1 Name and Surname	Massimiliano Confalonieri – Valter Meda
1.2 Country/Jurisdiction	Italy
1.3 Organisation	Agenzia Regionale per la Protezione dell’Ambiente (ARPA) della Lombardia
1.4 Position	Dirigente RUO BARAE – Tecnico UO BAE MI-MB
1.5 Duties	
1.6 Email address	m.confalonieri@arpalombardia.it v.meda@arpalombardia.it
1.7 Phone number	+39 335 531 8045



2. Site background

2.1 History of the site

The area in question is located in the territory of the Municipality of Villasanta (Monza and Brianza province), north of the Milan urban area and is geographically located in the high Lombard plain, immediately south of the pre-Alpine moraine hills.

The site was affected by the presence of an industrial plant built in 1971 and dedicated to the production of air conditioning equipment. Industrial production has ceased but the site retains its industrial use and the area is occupied by commercial and/or logistics activities.

The main production cycles concerned:

- mechanical processing of metals;
- oven painting with organic solvent paints;
- electrophoresis painting.

Both painting processes, discontinued in 1994, were supported by a waste water treatment plant. The main structures present were made up of:

- a purification plant (decommissioned in 1994) with two masonry tanks, a settler and a sludge drying tank;
- a thermal power plant, currently fuelled by methane;
- 5 underground tanks located about 10 m from the south west corner of the thermal power plant, n. 4 of which containing fuel oil and n. 1 containing diathermic oil. All fuel oil tanks would have been removed in 1991 during the construction of the underpass. The diathermic oil tank was removed and replaced with a new double-walled tank positioned along the east side of the thermal power plant. This latter tank also seems to have been removed in 1992 with the construction of the thermal power plant;
- 2 electrical transformer cabins, one located in the thermal power plant and one inside body C. The one in the thermal power plant has a single transformer and is currently not in use, with a concrete containment tank in good condition. The one inside body C is in use. Transformers with PCB-containing oils were reclaimed and replaced in 1989

The site was affected by a remediation procedure according to the regional regulations in force at the time that began before the entry into force of the Ministerial Decree of 25 October 1999, n. 471. Later, the process has been developed according to the ordinary operational and administrative procedures laid down by Legislative Decree 3 April 2006, n. 152.

Since the area is not included in the case of SIN or SIR in implementation of the regional

delegations, the competent authority in charge of the administrative acts is the municipal administration.

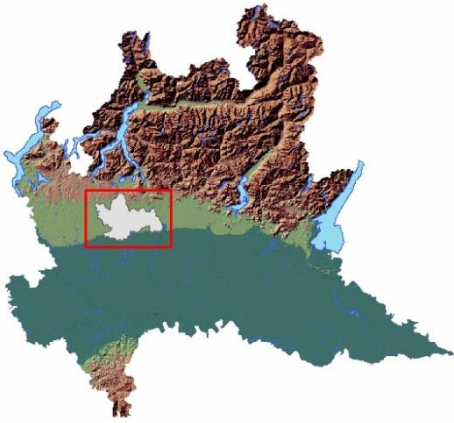

Lombardy – Monza Brianza Province

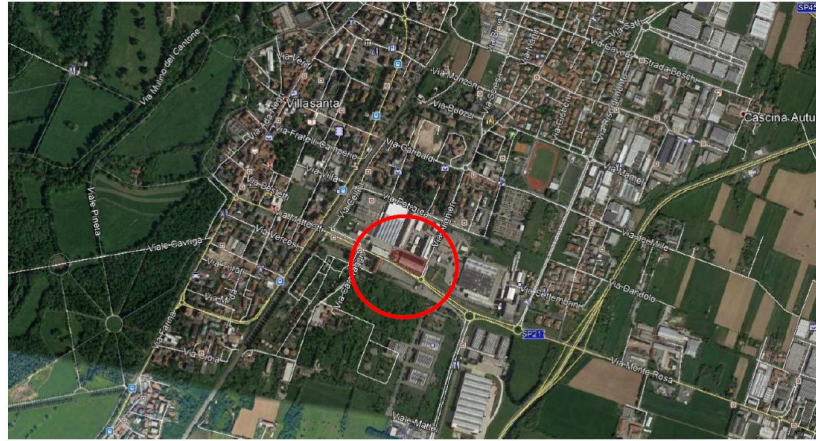

Villasanta – site location

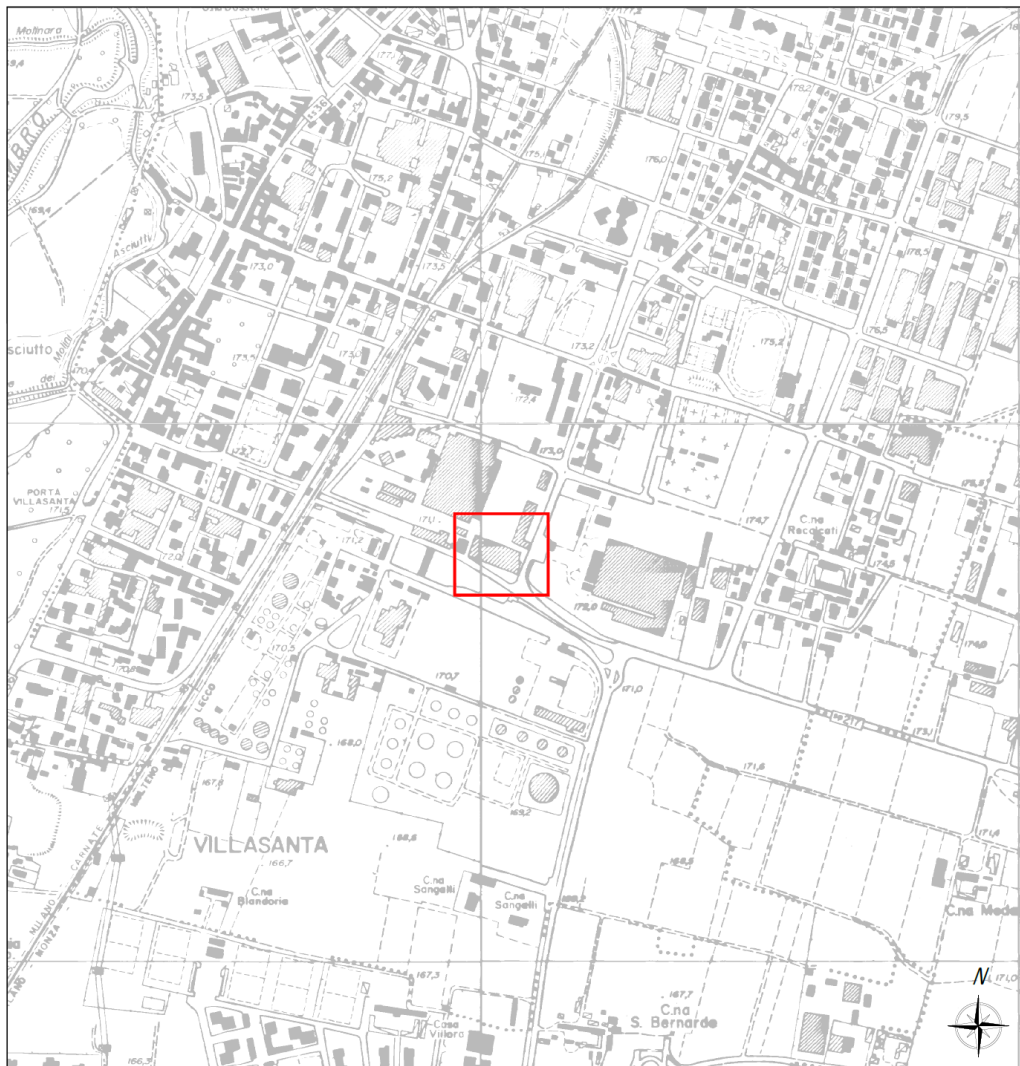

Base cartografica: Stralcio C.T.R. Regione Lombardia fogli B5c4, B5c5, B5d4, B5d5 scala 1:10.000 (mod)

Villasanta – site location (Technical Regional map 1:10:000)

2.2 Geological setting

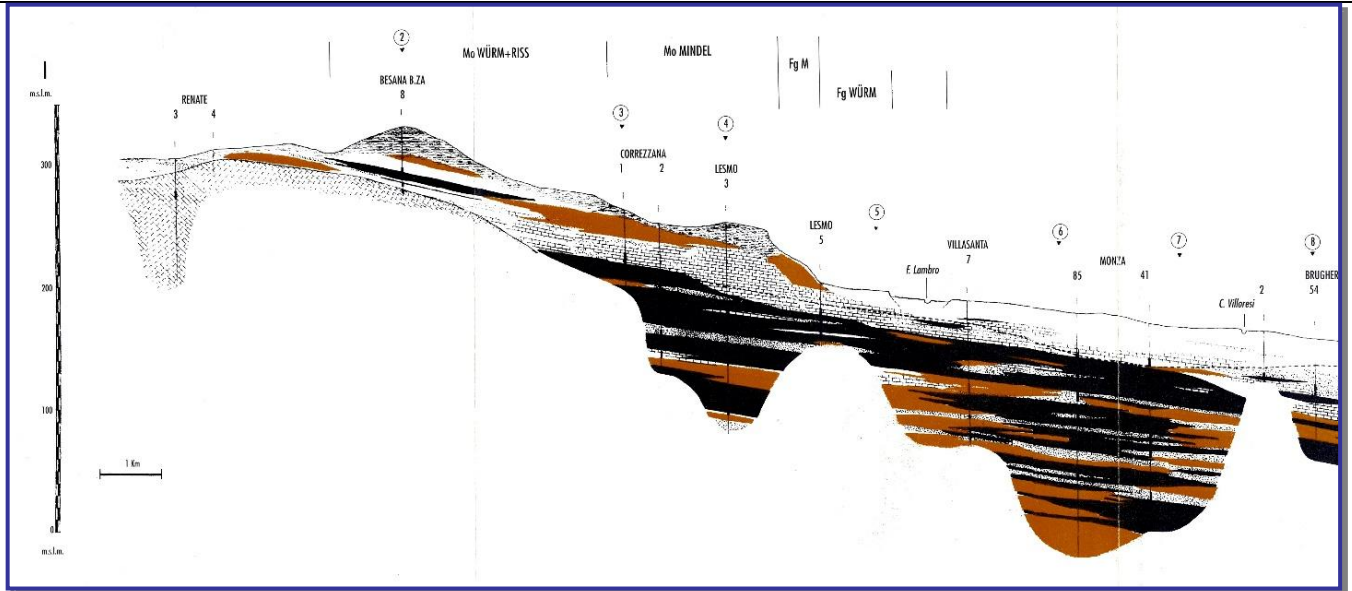

NS hydrogeological section of the central area and the Lambro basin (from: Provincia di Milano, 1995)

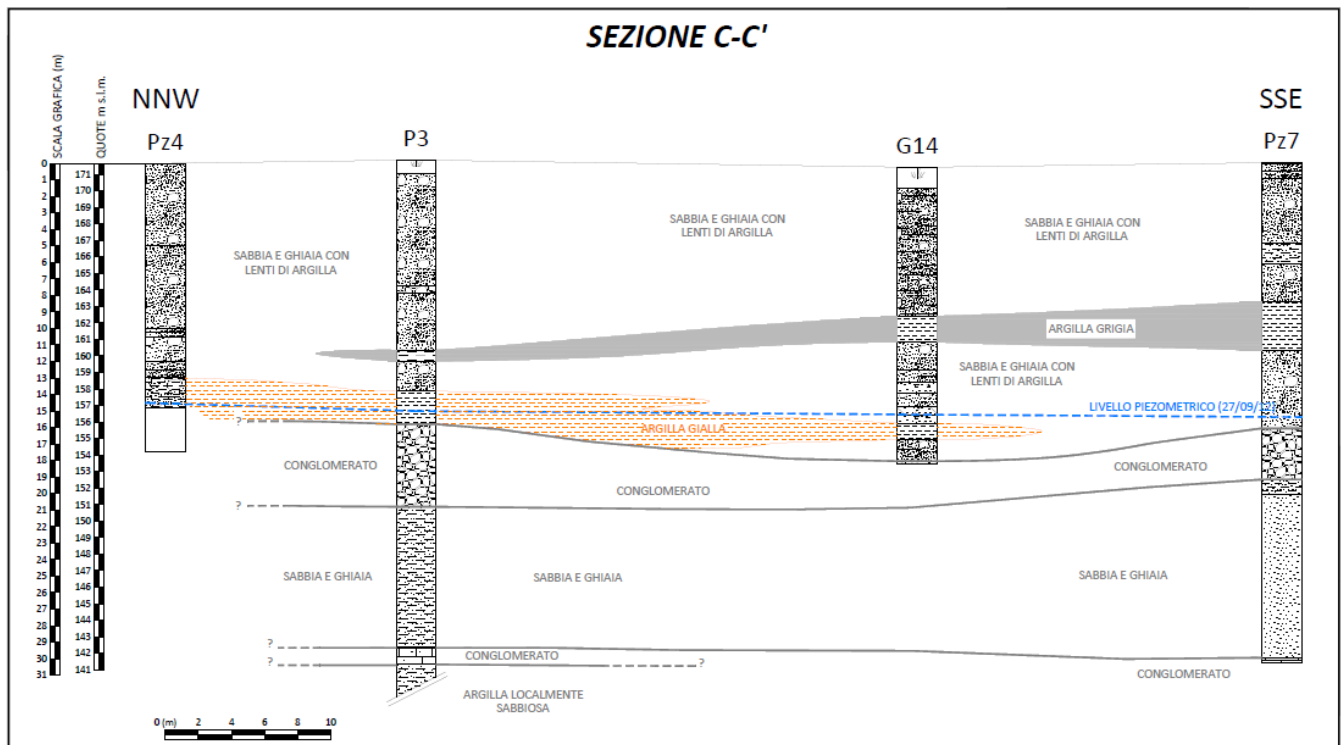

Stratigraphic detail of the intervention area

The western border of the municipal area coincides with the path of the Lambro river.

Geologically, the subsoil of Villasanta can be included within the Fundamental Level of the Plain (LFP), traditionally characterized by deposits of late Pleistocene fluvial-glacial origin, consisting of sands and gravels with pebbles that form the Lombard plain. Near the banks of the Lambro, more recent sediments develop which can be associated with the depositional activity of the watercourse itself. From a petrographic and lithological point of view, the origin of the Lambro deposits is strictly attributable to the portion of the pre-Alpine chain which, within the reference hydrographic basin, crops out in correspondence with the Larian triangle between Como and Lecco. This can be distinguished due to the outcrop of Mesozoic geological units of a predominantly calcareous nature.

The presence of the Lambro river also affects the alluvial sediments, whose deposition over time has given rise to real paleo-riverbeds with high transmissivity values. In general, in the area under examination, the subsoil is characterized in the superficial portion by the presence of mainly gravelly-sandy lithology horizons, with high permeability and thickness values. Proceeding in depth, the progressive lithological variations due to the prevalence of fine-textured lithologies (clays, silts and fine sands) determine a reduction in permeability. Under these conditions, the aquifer horizons are limited to isolated lenses of relatively permeable material and of modest thickness. The hydrogeological structure traditionally described by authors on the basis of the permeability characteristics has led to the identification of three main hydrostratigraphic units having the following characteristics:

- first aquifer: consisting of prevailing gravels and sands, with subordinate fractions of silts and gravelly-sandy horizons locally cemented. These sediments can be traced back to the recent and ancient alluvial and fluvio-glacial deposits from Würm (upper Pleistocene) which constitute the Fundamental Level of the Plain (LFP). This unit contains the upper part of the traditional aquifer, characterized by relatively high hydraulic conductivity values between 10^{-3} and 10^{-4} m/s. The characteristics of the aquifer are those typical of a free, unconfined water table;
- second aquifer: consisting of gravels and silty sands and conglomeratic horizons. These lithotypes are traditionally attributed to the ancient fluvio-glacial deposits of Mindel and Riss (lower Pleistocene) which on the surface give rise to the characteristic “ferretto” terraces of the foothills and hills of Brianza. The permeability of the aquifer which has hydraulic conductivity values of an order of magnitude lower than those of the first aquifer and equal to about 10^{-4} - 10^{-5} m/s. This aquifer can contain a free aquifer or, in the presence of horizons that are not very permeable to the roof, locally semi-confined, generally in connection with the one above. Where the piezometric load differences between the two aquifers are more significant, water exchanges between the aquifers may occur due to the phenomenon of drainage;



- third aquifer: characterized by predominantly fine-textured soils, such as silts and clays with fine sand levels. These deposits are attributed in literature to the so-called Villafranchian clays. Due to the clear prevalence of fine-grained lithotypes, the hydraulic conductivity values in sandy lenses are approximately 10^{-4} - 10^{-6} m/s. The sandy lenses themselves are home to confined and protected aquifers.
- In the area of Monza and Villasanta the hydrogeological characteristics of the subsoil are particularly different compared to the adjacent areas, in particular due to the presence of a high structure (Monza ridge) which causes the Villafranchian substrate to rise with a consequent reduction in the thickness of the aquifers. This hydrogeological situation makes it possible, in the sector east of the Lambro river, to interconnect the first and second aquifers with consequent possible mixing between contaminated aquifers and good quality aquifers.

The superficial aquifer (groundwater) is contained in the sediments that form the gravelly-sandy-silty unit and the conglomeratic unit (Ceppo auct.). As already mentioned, the two units are only locally separated by semi-permeable deposits which can give rise to differences in the piezometric level, although, in general, compared to the adjacent western area, the traditional aquifer is substantially undifferentiated. In the area under examination (Villasanta) the presence of a suspended aquifer supported by a discontinuous silty-clayey lens and contained in deposits with a prevalently gravelly-sandy texture was also ascertained.

2.3 Contaminants of concern

The site is characterized by the presence of contamination:

Soil and subsoil

The characterization investigations on the entire site have shown overall compliance with the CSCs envisaged for the specific intended commercial and industrial use.

On the basis of historical investigations and analyses carried out by means of soil gas survey, the presence of tetrachlorethylene was ascertained in the entire horizon thickness unsaturated underlying the building in which the main painting cycles and degreasing of materials was carried out.

The figure below shows the values measured in the interstitial gases during the characterization phase and before the application of the SVE technology.

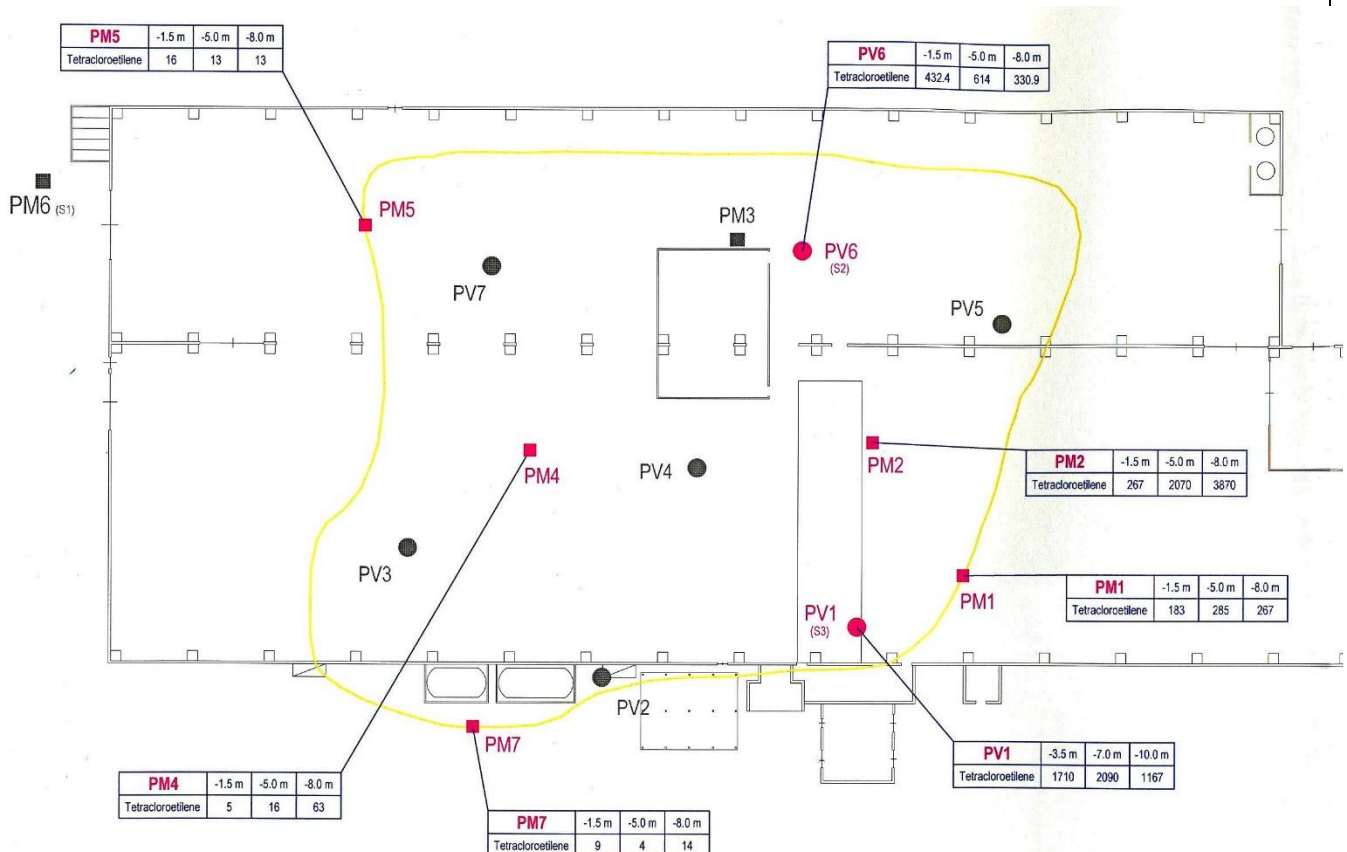

Groundwater

Contamination of the groundwater in the area is essentially and almost exclusively due to tetrachlorethylene (PCE), with associated low concentrations of trichloroethylene (TCE) and chloroform (TCM). The presence of this substance in concentrations up to



400 times the CSC is well above the background value that is generally found in most of the area north of Monza and which roughly corresponds to the values found "at the entrance" to site, in the hydrogeologically upstream piezometer, between 6.5 and 48µg/l.

High concentrations were detected in 2002 throughout the south-eastern portion of the plant, in correspondence with some wells, with values up to 473 µg/l. The origin of the contamination has been traced back to the washing and degreasing of pieces using PCE, a solvent stored in underground tanks present in the building subject to the renovation.

CodiceSIF	denonint	data	PCE
0152390026	Well 3	11-mar-04	180
		14-set-04	198
		07-apr-05	61.14
		23-mar-06	28.7
		22-mag-07	286
		25-lug-08	340
0152390043	Well 5	11-mar-04	28
		14-set-04	168
		07-apr-05	27.6
		23-mar-06	22.2
		22-mag-07	22
		25-lug-08	7.5
0152390054	Pz 1 (upgradient)	11-mar-04	48
		14-set-04	39
		07-apr-05	21.7
		23-mar-06	8.6
		22-mag-07	6.5
		25-lug-08	6.7
0152390065	Pz 2 (downgradient)	11-mar-04	11
		14-set-04	19.37
		07-apr-05	3.99
		23-mar-06	5.8
		22-mag-07	4.2
		25-lug-08	4.2
0152390066	Pz 3 (upgradient)	11-mar-04	4.6
		14-set-04	3.2
		07-apr-05	3.04

0152390067	Well 6 (pumping well)	23-mar-06	4.69
		22-mag-07	7.1
		25-lug-08	0.7
		11-mar-04	200
		14-set-04	213
		07-apr-05	64.32
		20-mar-06	42.29
		22-mag-07	38.6
		25-lug-08	320

The map shows the points of the monitoring network in the configuration active in 2010

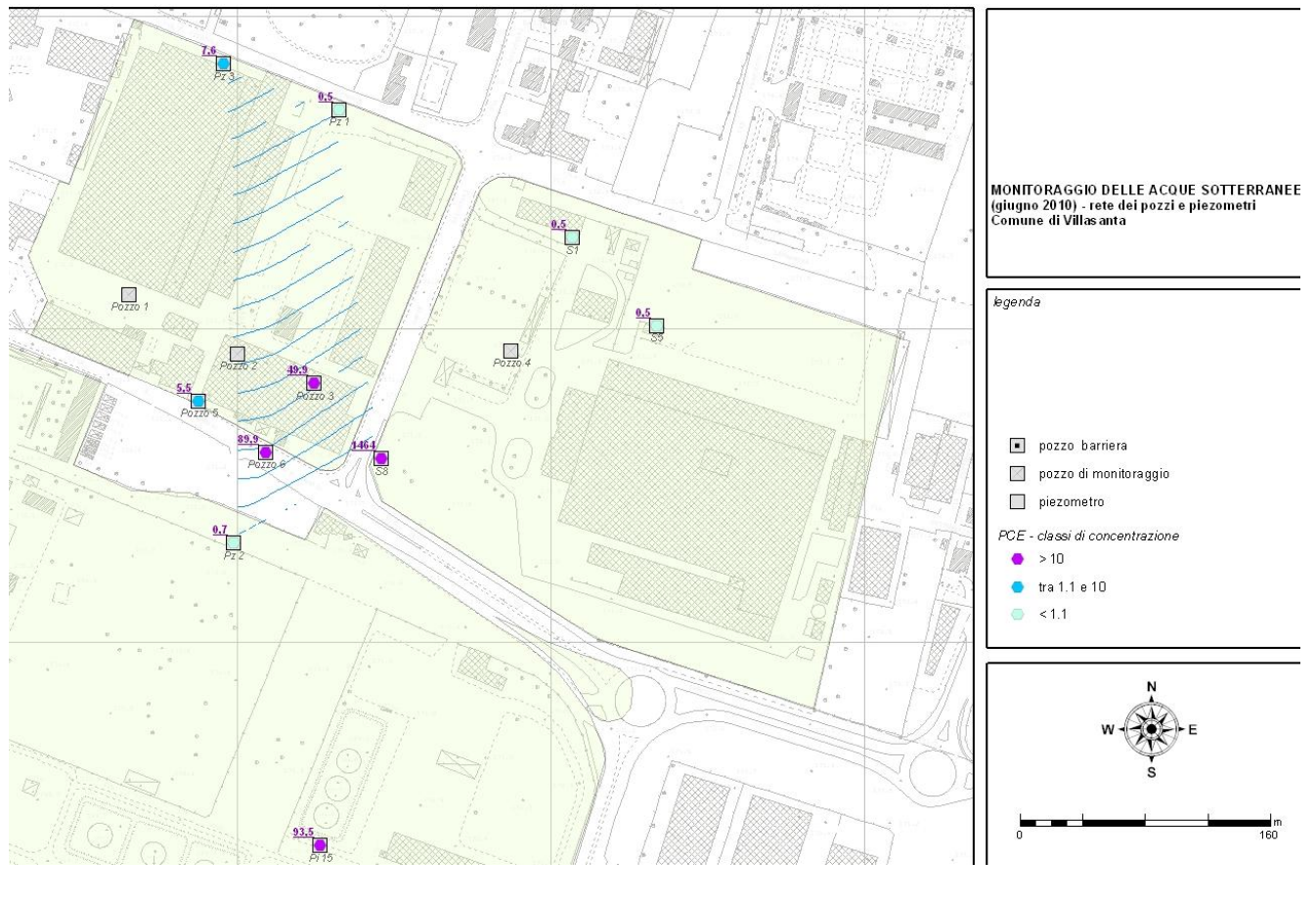



2.4 Regulatory framework

The remediation process of the area had been started before the national legislation on the remediation of contaminated sites came into force (Legislative Decree 22/97 and Ministerial Decree 417/99), applying the reference standards already existing in the Lombardy Region before 1997.

During the verification of the interstitial gases carried out at the building called "former Battery Department" or "former Building B", located in the south-east portion of the plant, the presence of PCE was detected in the interstitial gases and in excess concentrations to the regulatory limits even in groundwater.

In light of this, the company has sent its notice pursuant to dell' art. 242, paragraph 1 of Legislative Decree 152/06 to the competent local authorities in February 2011.

Following this communication, the Characterization Plan of the area on which the former Building B stands was drawn up and sent to the Authorities, subsequently approved in the Conference of Services in May 2011 by the competent Authority.

In July-August 2012 a new interstitial gas sampling campaign was carried out; with the results obtained, relative to the PCE concentrations, it was possible to redefine the spread of contamination in the subsoil, the starting point for the elaboration of the Risk Analysis.

The site-specific Health and Environmental Risk Analysis document was favourably assessed with prescriptions by the Authorities during the Service Conference in October 2012.

Therefore, in 2012 an additional document with acceptance of Conference of Services prescriptions that defines the CSR for soil gas and groundwater as remediation targets was prepared.

Following approval of the remediation objectives, equal to 71 mg/m³ of PCE in soil gas for the unsaturated portion of land, a remediation project of the total subsoil was drawn, which also included the portion of the aquifer assessed in the Conference of Services in March 2013 with related observations and additions by the Authorities.



3. Pilot-scale application in field

3.1 Extraction system

The technology applied for the remediation of the area consisted of the combination of an extraction plant (SVE) for unsaturated soil, associated with an Air-Sparging (AS) plant for the remediation of groundwater (saturated).

In consideration of the geological-stratigraphic structure of the soil, characterized by the alternation of horizons with coarse and medium fine textures, the design of the SVE plant was carried out on the basis of data already available on site, having been active in a network of wells for interstitial gas measurement.

For the correct sizing of the AS system, a pilot module was instead prepared.

In relation to the local stratigraphic succession and in particular to the presence of clay lenses in the area to be reclaimed, the overall system of SVE and AS was created with the following characteristics:

- n. 18 suction wells of which:
 - n. 5 "shorts" (PV1, PM2, PV6, VW14 and VW15) → with filtering section between pc and the roof of the first clay lens, used for the remediation of unsaturated soil, possibly still polluted.
 - n. 7 "intermediate" wells (VW1 - VW7) → with filtering section between the first and second clay lens, necessary to concentrate the recall of polluting vapours in this area, where the effect of AS will be greater and where the vapours will concentrate;
 - n. 6 "long" wells (VW8 - VW13) → with filtering section between 6 and 14-15 m deep, or in any case one meter above the height of the phreatic surface, will instead have the function of area limiting the diffusion of the AS effect and treat the vapours deriving from the groundwater.
- n. 6 insufflations wells (AS1 - AS6) located inside the former Battery Department, in the area of maximum PCE concentration in interstitial gases. In the pilot scale application, the construction of a well for insufflations of groundwater (AS/G14) and n. 6 monitoring wells positioned around the AS;
- n. 2 SVE systems, consisting of a condensate separator, a side channel aspirator and an activated carbon filter, of which:
 - plant 1 to which the "short" wells are connected;
 - plant 2 to which the "intermediate" and "long" wells are connected;
- n. 1 AS system consisting of a blower in correspondence with each AS well, capable of blowing air at the established flow rates and pressures.
- n. 3 monitoring wells, necessary especially in the initial start-up phase, to check the

influence rays of the venting wells.

The system was initially launched in the pilot phase and after two months, once the functional and monitoring data of the system itself had been acquired, it came into operation at full capacity.

The data collected during the monitoring made it possible to regulate flows and depressions of the plants. The results obtained from monitoring with colorimetric vials, on the other hand, gave a more precise indication of the presence of PCE in interstitial gases. Over time, the outermost wells were closed, particularly in the westernmost area where the PCE values were zero, in order to concentrate the area of influence of the SVE in the most critical areas.

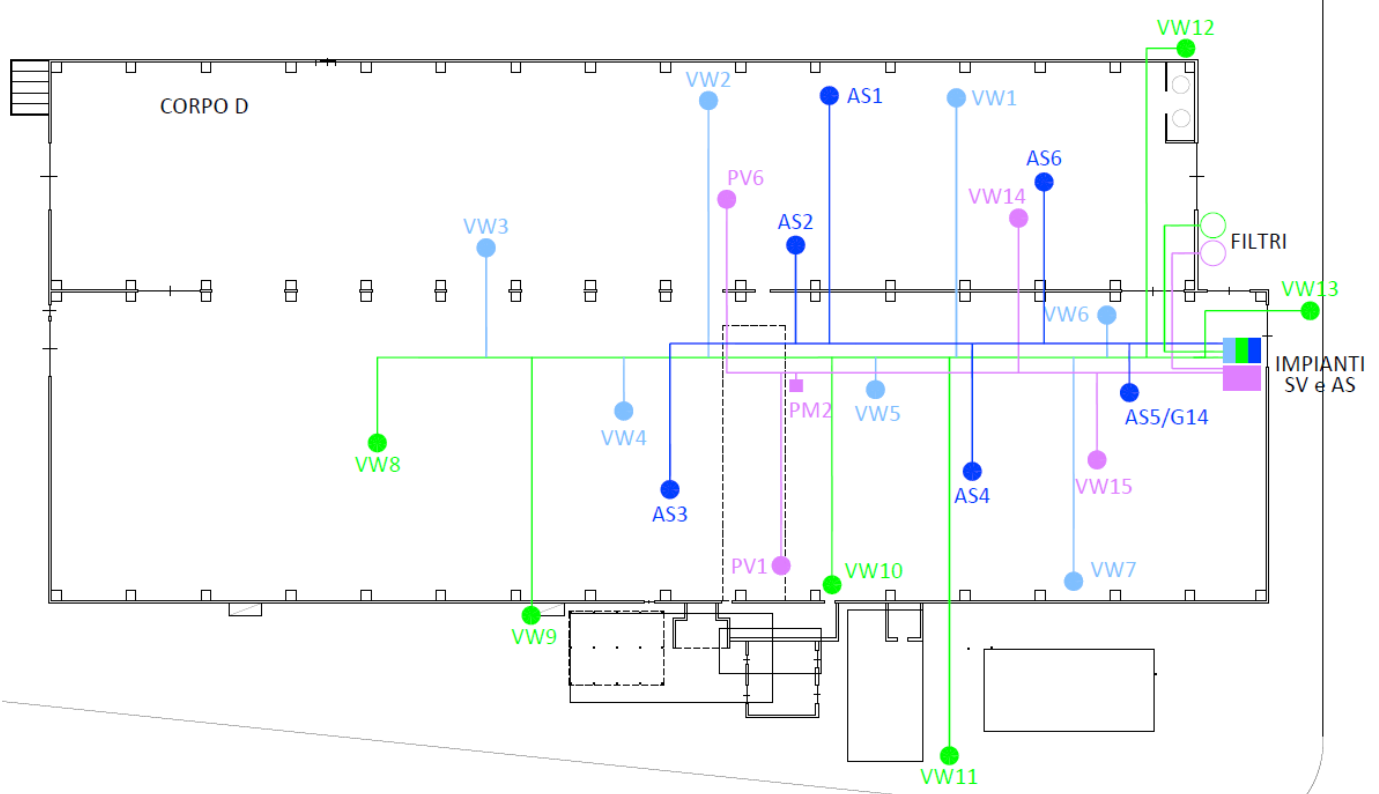

Position of the AS and SVE wells

3.2 Injection system

The AS plant was divided into n. 6 insufflations wells (AS1 - AS6) located in the area of maximum PCE concentration in interstitial gases.

In the pilot scale application, a well for insufflation of groundwater (AS/G14) and n. 6 monitoring wells were constructed positioned around the AS.

The carrier gas used was air, injected through diffusers to maximize the flow and increase the area exposed to the treatment. Thanks to the diffusion of high air flow, distribution was homogeneous in the contaminated area and the stripping effect of the volatile contaminants (PCE) from groundwater which are then extracted by SVE was amplified.

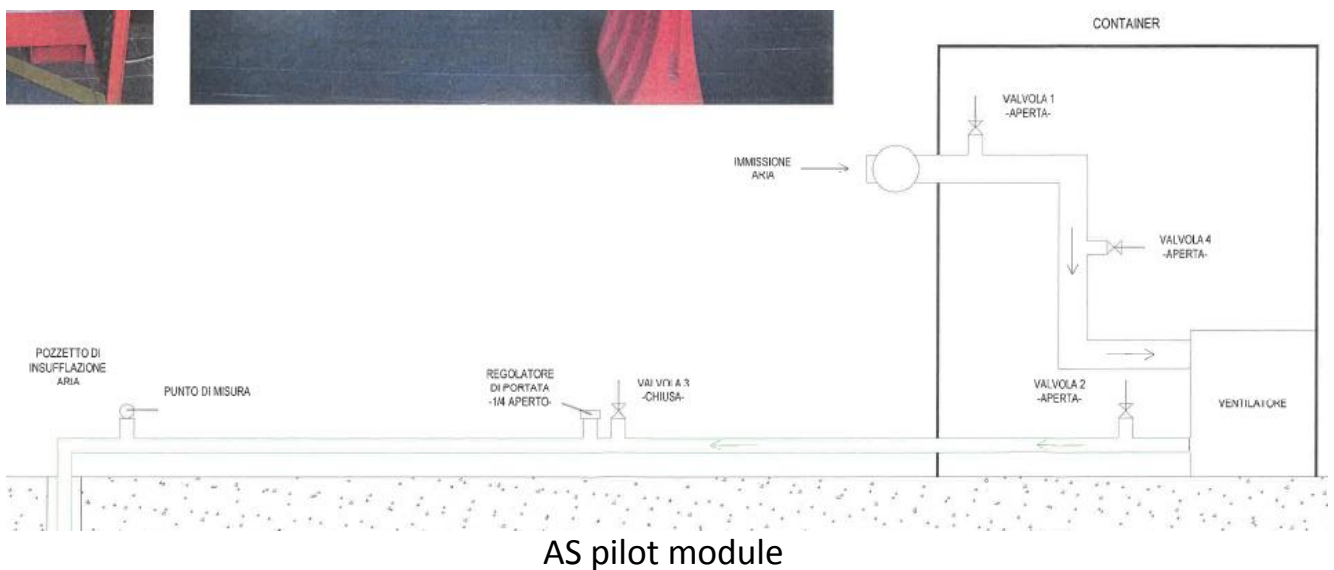

3.3 Radius of influence

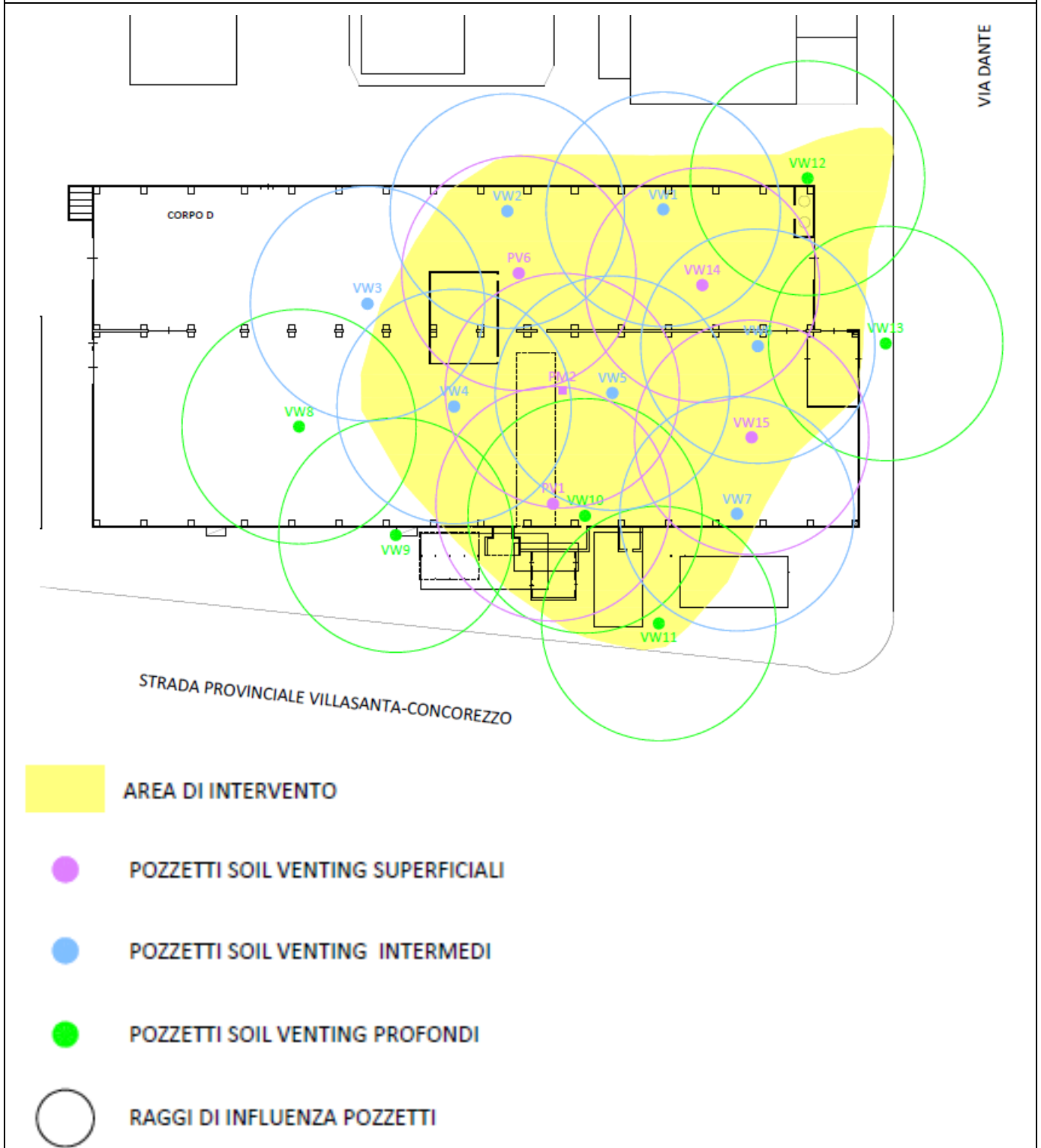



On the basis of the bibliographic data already present for the site and in particular those derived from the implementation of the previous reclamation project, from the stratigraphic observations carried out during the investigations and from the pilot test carried out and described in the previous chapter, it was possible to hypothesize a range of influence for each suction pit equal to 15 m.

The location of the suction points has been selected in such a way that the respective rays of influence are sufficiently coalescing and there are no unaffected areas within the area to be reclaimed.

3.4 Off gas Treatment

As a real pilot phase was not foreseen for the development of the SVE system (it should be remembered that there was a monitoring system of interstitial gases built in application of regional legislation on site for some time and before the planning of the reclamation interventions), the gaseous effluent treatment system corresponds to that envisaged by the operational reclamation interventions when fully operational.

In this regard, see the answer to question 4.4

4. Full-scale application

4.2 Injection system

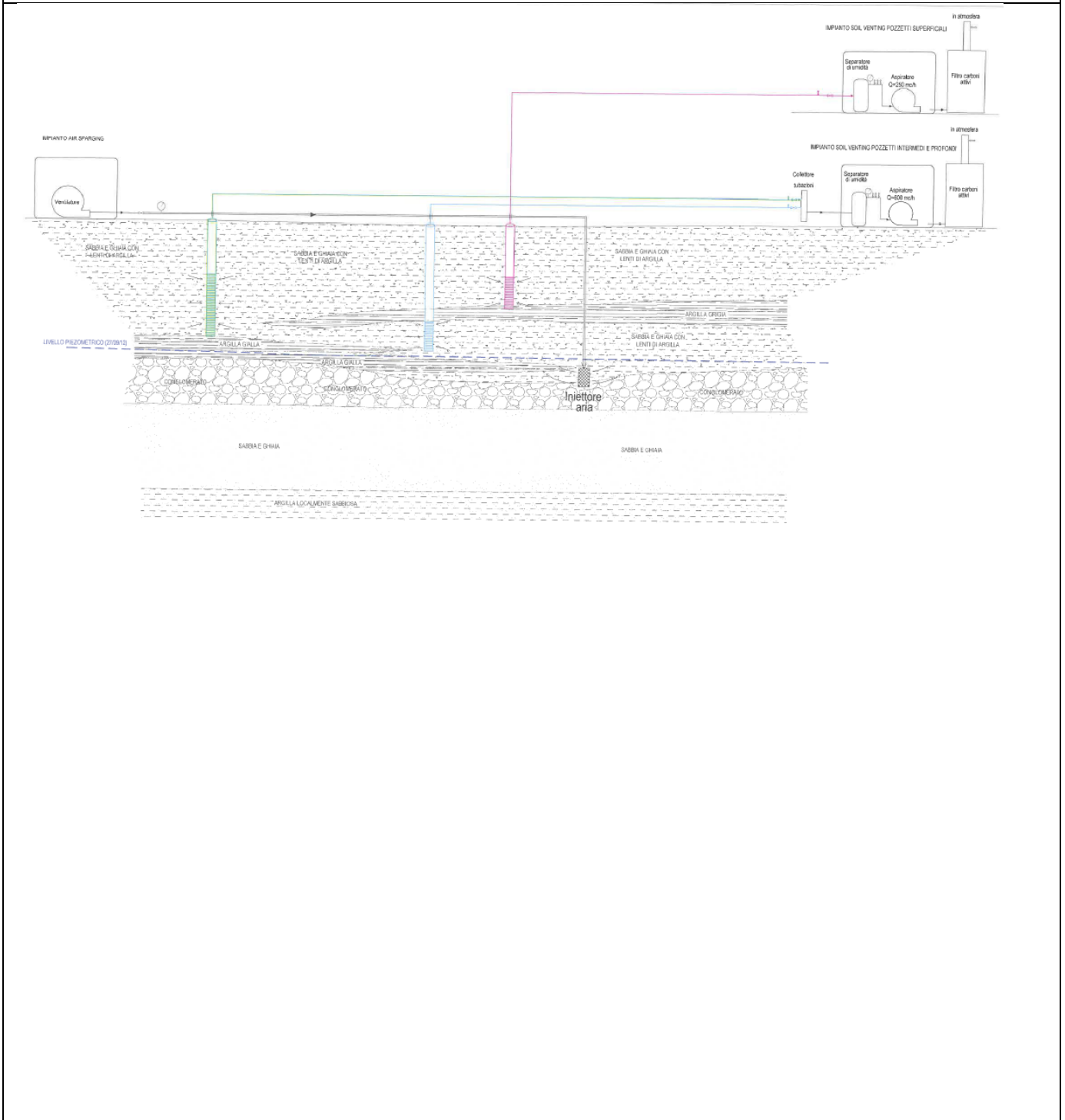



4.4 Off gas Treatment

Based on the characteristics and functions of the wells, these were connected to two separate suction systems integrated with attached activated carbon filters.

The vapours deriving only from the "short" suction wells with an indicative flow rate of 250 m³/h were collected in plant 1.

The vapours deriving from the "intermediate" and "long" suction wells were collected in plant 2 with a total suction flow rate of 650 m³/h (approximately 50 m³/h for each suction well).

A condensate separator was provided prior to the connection to the activated carbon filter.

The following are the characteristics of the activated carbon filter:

- Estimated gas flow: 650 m³/h;
- Filtering surface: 3.0 m²;
- Filter material volume: 7.0 m³/h;
- Contact time: 38.77 s;
- Filtration speed: 0.06 m/s;
- Active carbon quantity: 4,000 kg;
- Filter layer height: 2,800 mm;
- Inlet/outlet pipe diameter: 100 DN



4.5 Control parameters

Describe the monitoring plan designed to evaluate the effectiveness of SVE in the three dimensions. List the control parameters considered.

The direct verification of the radius of influence of the venting wells was carried out through 3 monitoring wells with a depth of 8 m from a pc, equipped with a 2 "PVC pipe, blind for the first 2 m and micro-slotted at -2 m at the bottom of the hole. The perforation-pipe cavity was filled with selected silicon gravel in the micro-cracked sections and with cement/bentonite grout in the blind top sections.

The monitoring operations include both on-site analyses, using portable instrumentation, and laboratory gas chromatographic analyses, by taking air samples from activated carbon vials, in order to calibrate the analyses performed on site.

The following parameters were determined on site, both refer to the entire system (measurement point at the collector) and to the individual wells:

- Air speed (m/s) by means of hot wire anemometer;
- Air temperature (° C) by means of a thermo hygrometer;
- Air humidity (%) by means of a thermo hygrometer;
- Depressions realized in the suction wells (mbar) by means of a digital manometer;
- SOV concentrations present in the air stream (ppm) by PID;
- PCE concentrations (ppm) through the use of colorimetric vials of suitable Gastec or similar scale, through sampling at the suction points.



6. Post treatment and/or Long Term Monitoring

6.1 Post treatment and/or Long Term Monitoring

The system was launched on October 8, 2013; the start-up phase took place in the following two months, during which the SVE and AS plants were activated by successive steps. From 4 December 2013, the plants operated at full capacity until 2 October 2017. During the entire period of operation of the reclamation plants, the functionality checks of the plants themselves and the monitoring of interstitial gases were regularly carried out in correspondence with the SVE wells.

The data collected during the monitoring made it possible to regulate flows and depressions of the plants.

The results obtained from the monitoring with colorimetric vials, on the other hand, gave a more precise indication of the presence of PCE in interstitial gases. Over time the outermost wells were closed, particularly in the westernmost area, where the PCE values were zero, in order to concentrate the area of influence of the SVE in the most critical areas.

As described in the last Technical Report drawn up in August 2017 before the shutdown of the plants, from the results of the monthly monitoring, it was found that:

- in a large area of that subjected to remediation, including the west, north-central and south-east corner, the PCE values in the measured soil gases reached concentrations close to or equal to zero, starting from July 2014;
- the wells located in the two limited areas of the central-eastern (VW6, VW13, VW14) and central-southern (VW10, VW11) zones also had values below the limit of 10.47 ppm of PCE and close to zero.
- the only point where the PCE was found in concentrations in soil gases close to the reclamation objective, was the VW12, located north-east of the former Battery Department;
- in correspondence with this well, sampling was then carried out by means of ac vials and laboratory analyzes. The analytical data confirmed compliance with the limits set downstream of the risk analysis.

Given the trends in PCE concentrations in the monitored SVE wells, in October 2017 the plants were shut down and the first phase of soil testing was started, by carrying out n. 2 on/off cycles of the systems to check for any rebound phenomena.

As indicated in the act of approval of the subsoil remediation project for the Carrier plant in Villasanta, the remediation objectives for the unsaturated soil matrix can be considered achieved when "... the results of the interstitial gas tests will attest to concentrations lower than 71 mg/m³ of PCE in all the monitoring wells for at least two



campaigns carried out in different seasonal climatic conditions... "

The first test of unsaturated soil was carried out in 2018 with the two semi-annual sampling campaigns in June and November.

Given the negative results obtained during the second sampling in November 2018, the SVE plants were restarted until April 2019 for a total period of about 5 months and then the absence of rebound phenomena was verified through ignition/shutdown cycles.

The second phase of testing of unsaturated soil was therefore launched, carried out with the two six-monthly samplings respectively in July 2019 and January 2020. The results of the activities carried out in the two testing campaigns certified compliance with the authorized remediation objectives.



7. Additional information

7.1 Lesson learnt

The interventions that affected the site were carried out by an American multinational which, in line with its corporate policy, paid particular attention in terms of financial resources in the choice of the best performing remediation technology for the type of pollution (PCE) and for the particular site specific conditions (contamination of the unsaturated and saturated, with the presence of more contaminated horizons).

The use of interstitial gas sampling techniques and identification of remediation objectives with concentrations referring to the aeriform matrix present in the unsaturated soil represents one of the first cases of application in Lombardy (the first sampling had already been carried out before 2010, in the absence of guidelines and regulatory guidelines).

It is therefore a reference case study for the development of the pore gas measurement methodology that has been progressively implemented.

The SVE technology, associated with an AS plant and a Pump & Treat system, has been found to be effective in reducing the level of contamination present in the soil and groundwater.

At the administrative level, it is necessary to highlight the difficulties in defining the remediation objectives, considering that the legislation and technical guidelines in force at the time made the use of values in interstitial gases as a reference for site certification with little applicability.

From a technical point of view, it should be noted that the first soil characterization carried out with traditional techniques (sampling of soil by continuous core drilling and laboratory analysis) did not show that the table limits were exceeded, underestimating the actual state of contamination of the site.

The use of data from the measurement of interstitial gases in the second phase of characterization, however, made it possible to ascertain an effective contamination of the unsaturated soil, identifying at the same time the secondary source responsible for the contamination in the groundwater.



Glossary of Terms

Term (alphabetical order)	Definition
VOC	Volatile organic compounds
SIN	Contaminated site of National Priority List
SIR	site of regional importance
CdS	Conference of Services
CSC	Contamination Threshold Concentrations
CSR	Risk Threshold Concentrations
SVE	Soil Vapor Extraction
AS	Air Sparging
PCE	Perchloroethylene (= Tetrachloroethylene)
TCE	Trielin (= Trichloroethylene)
TCM	Chloroform (= Trichloromethane)
P&T	Pump and Treat