

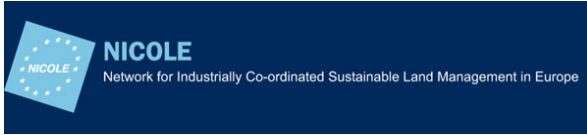

European Union Network for the Implementation  
and Enforcement of Environmental Law



Working Group  
Contamination

# Raport privind extracția vaporilor din sol (SVE)

---

*Raport final*

**Data raportului: 8 noiembrie 2021**  
**Numărul raportului: 2020/09 SVE RO**

## Introducere privind IMPEL

Rețeaua Uniunii Europene pentru punerea în aplicare și asigurarea respectării legislației de mediu (IMPEL) este o asociație internațională non-profit a autorităților de mediu din statele membre ale UE, din țările în curs de aderare și din țările candidate la Uniunea Europeană și din țările SEE. Asociația este înregistrată în Belgia, iar sediul său legal fiind în Bruxelles, Belgia.

IMPEL a fost înființată în 1992 drept rețea informală a autorităților europene de reglementare și a autorităților preocupate de punerea în aplicare și respectarea legislației de mediu. Obiectivul rețelei este de a crea impulsul necesar în Comunitatea Europeană pentru a face progrese în ceea ce privește asigurarea unei aplicări mai eficiente a legislației de mediu. Activitățile principale ale rețelei IMPEL se referă la sensibilizarea, consolidarea capacităților și schimbul de informații și de experiențe privind punerea în aplicare, aplicarea și colaborarea internațională în materie de aplicare, precum și la promovarea și sprijinirea practicabilității și a aplicabilității legislației europene de mediu.

În ultimii ani, IMPEL s-a transformat într-o organizație importantă și cunoscută pe scară largă, fiind menționată într-o serie de documente legislative și politice ale UE ca, de exemplu, în cel de-al 7-lea Program de acțiune pentru mediu și în Recomandarea privind criteriile minime pentru inspecțiile de mediu.

Expertiza și experiența participanților din cadrul IMPEL fac ca rețeaua să fie calificată în mod unic pentru a lucra atât la aspectele tehnice, cât și la cele de reglementare ale legislației de mediu a UE.

Informații despre rețeaua IMPEL sunt disponibile și pe site-ul web al acesteia la adresa: [www.impel.eu](http://www.impel.eu)

Suggested citation:

Falconi M. et al. (2021), Raport privind extracția vaporilor din sol (SVE). IMPEL, COMMON FORUM, EIONET, NICOLE report no 2020/09 SVE RO, 301 pages. Brussels, ISBN 978-2-931225-16-5

ISBN 978-2-931225-16-5



9 782931 225165

<b>Titlul raportului:</b> Raport privind extracția vaporilor din sol (SVE)	<b>Numărul raportului:</b> 2020/09 SVE RO	
<b>Raport adoptat în cadrul Adunării Generale IMPEL:</b> 7-8 Decembrie 2021, Ljubljana (Slovenia)	<b>Numărul total de pagini:</b> 301  <b>Raport:</b> 49 pagini <b>Anexe:</b> 252 pagini	
<b>Manageri de proiect:</b>		
Marco Falconi (IT)	IMPEL	ISPRA
Dietmar Müller-Grabherr (AT)	Common Forum	Umweltbundesamt AT
Frank Swartjes (NL)	EIONET WG Contamination	RIVM
Tomas Albergaria (PT)	NICOLE	Instituto Politécnico do Porto
<b>Autori:</b>		
Dietmar Müller-Grabherr (AT)	Common Forum	Umweltbundesamt AT
Tomas Albergaria (PT)	NICOLE	Instituto Politécnico do Porto
Francesca Benedetti (IT)	IMPEL	MITE (Consultant)
Iustina (Popescu) Boajă (RO)	-	IGR
Said El Fadili (BE)	IMPEL	ENVIRONNEMENT BRUSSELS
Marco Falconi (IT)	IMPEL	ISPRA
Federico Fuin (IT)	IMPEL	ARPAV
Gabriella Grima (MT)	IMPEL	ERA
Dirk Krebs (DE)	IMPEL	REGIERUNGSPRÄSIDIUM DARMSTADT
Liviu Constantin Matei (RO)	IMPEL	GNM
Diana Perșă (RO)	-	IGR
Christina Pisani (MT)	IMPEL	ERA
Alex Plows (UK)	IMPEL	CYFOETHNATURIOLCYMRU
Andrea Sconocchia (IT)	IMPEL	ARPA UMBRIA
Asa Valley (SE)	EIONET WG Contamination	NATURVÅRDSVERKET
<b>Colaboratori pentru elaborarea Anexa 1 ISCO:</b>		
Federico Caldera (IT)	MARES	
Simone De Fazio (IT)	GOLDER ASSOCIATES	
Boris Devic-Bassaget (FR)	SUEZ RR IWS REMEDIATION FRANCE	
Paola Canepa (IT)	ARPA LOMBARDIA	
Massimiliano Confalonieri (IT)	ARPA LOMBARDIA	
Sophia Dore (US)	GHD	
Alain Duchene (BE)	HAEMERS TECHNOLOGIES	
Daniela Fiaccavento (IT)	ARPAV	
René Fillion (US)	GHD	
Jan Haemers (BE)	HAEMERS TECHNOLOGIES	
Aline Jordens (BE)	HAEMERS TECHNOLOGIES	
Angela Rosa Marin (IT)	ARPA LOMBARDIA	
Valter Meda (IT)	ARPA LOMBARDIA	
Davide Menozzi (AU)	GHD	

Paola Panzeri (IT)	ARPA LOMBARDIA
Mathieu Petitjean (BE)	HAEMERS TECHNOLOGIES
Sara Puricelli (IT)	ARPA LOMBARDIA
Jean Rhone (FR)	HAEMERS TECHNOLOGIES
Diego Ricci (IT)	ARPA LOMBARDIA
Hatem Saadaoui (BE/TN)	HAEMERS TECHNOLOGIES
Luca Sacilotto (IT)	RAMBOLL
Valentina Sammartino (IT)	ARPA CAMPANIA
Hadas Sharon (IL)	LUDAN ENVIRONMENTAL TECHNOLOGIES
Ewa Szczebak (PL)	ARCADIS
Corrado Thea (IT)	GOLDER ASSOCIATES
Aldo Trezzi (IT)	RAMBOLL
Mathieu Vion (FR)	SUEZ RR IWS REMEDIATION FRANCE

**Recenzori:**

Federico Caldera (IT)	MARES
Craig Cox (US)	COX COLVIN & ASSOCIATES
Mathieu Petitjean (BE)	HAEMERS TECHNOLOGIES

**Rezumat**

*Cuvinte cheie*

Extracția vaporilor din sol, remediere durabilă, sol, ape subterane, politica solului, remediere, mediu, fără preluare netă de teren, poluare, situri poluate, contaminare, situri contaminate, monitorizare, test pe teren.

*Grupuri țintă*

Autoritățile competente pentru aprobarea/aplicarea/monitorizarea tehnologiilor de remediere, operatorii industriali, agențiile de protecție a mediului, organismele de protecție a naturii, inspectoratele de mediu, monitorizarea mediului și instituțiile de cercetare, universitățile tehnice, asociațiile de mediu, ONG-urile, companiile și asociațiile de asigurări, consultanții de mediu.

Ca parte a programului de lucru pentru 2020, rețeaua IMPEL a creat acest proiect "Remediarea apei și a terenurilor" (2020/09) ținând cont de criteriile de evaluare a aplicabilității tehnologiilor de remediere.

Proiectul "Water and Land Remediation" are drept punct de plecare definițiile și etapele-cheie ale aplicării tehnologiilor de remediere și se concentrează asupra procedurilor tehnice legate de tehnologiile de remediere. Scopul final al proiectului este de a obține un document care să prezinte criteriile de evaluare a propunerii de aplicare a tehnologiei de remediere, pentru a explica aplicabilitatea, precum și ce trebuie făcut în cadrul testelor de teren și în extrapolarea aplicării acestora la scară largă. Anexa 1 cuprinde o serie de studii de caz, care pot ajuta cititorul să anticipeze orice probleme cu care s-ar putea confrunța și să evalueze dacă soluția oferită se aplică zonei respective, știind că fiecare sit contaminat diferă de altele și că este întotdeauna necesară o abordare specifică pentru fiecare sit în parte.

Obiectivul proiectului de remediere a apei și a solului pentru 2020-2021 a fost să se concentreze pe două tehnologii de remediere, Oxidarea Chimică *In Situ* și Extracția Vaporilor din Sol.

În cele din urmă, proiectul de remediere a apei și a terenurilor intenționează să contribuie la promovarea aplicării tehnologiilor de remediere *in situ* și la fața locului pentru sol și ape subterane și la o mai mică aplicare a tehnologiilor Dig & Dump și Pump & Treat, care sunt tehnici utilizate pe scară largă în Europa, dar care nu sunt sustenabile pe termen mediu și lung. Solul și apa sunt resurse

naturale și, atunci când acest lucru este fezabil din punct de vedere tehnic, ar trebui recuperate, nu irosite.

### **Mulțumiri**

Acest raport a fost revizuit de către o echipă mai largă a proiectului IMPEL și de către echipa de experți IMPEL pentru apă și terenuri, rețeaua COMMON FORUM, rețeaua NICOLE, grupul de lucru EIONET Contaminare și un grup de evaluatori externi.

## Declinarea răspunderii

---

Această publicație a fost pregătită în cadrul proiectului IMPEL Water & Land Remediation cu sprijinul rețelelor partenere interesate de gestionarea siturilor contaminate. Scris și revizuit de o echipă de autori, documentul de față intenționează să servească drept sursă primară de informații pentru a crea punți de legătură și a extinde cunoștințele între țările și regiunile europene. Această publicație facilitează o înțelegere comună a potențialului tehnologiei specifice de remediere.

Conținutul prezentat aici se bazează pe bibliografia relevantă, pe experiența autorilor și pe studiile de caz colectate. Este posibil ca documentul să nu acopere toate situațiile în care această tehnologie a fost sau va fi aplicată. Studiile de caz (a se vedea anexa) reprezintă contribuții voluntare recunoscute. Echipa de autori nu a avut ca sarcină evaluarea sau verificarea rapoartelor studiilor de caz.

De asemenea, este posibil ca unele țări, regiuni sau autorități locale să fi adoptat legislație, norme sau ghiduri specifice pentru a încadra aplicațiile tehnologiei și aplicabilitatea acesteia.

Prezentul document NU este conceput ca un ghid sau ca un document de referință BAT pentru această tehnologie. Configurațiile pedologice, geologice și hidrogeologice ale siturilor contaminate din Europa prezintă o mare variabilitate. Prin urmare, proiectarea și punerea în aplicare adaptate la fiecare sit în parte este esențială pentru succesul remedierii siturilor contaminate. Astfel, orice recomandare raportată ar putea fi aplicată, parțial aplicată sau neaplicată. În orice caz, autorii, colaboratorii și rețelele implicate nu pot fi considerați responsabili.

Opiniile exprimate în acest document nu sunt neapărat cele ale membrilor individuali ai rețelelor subsemnate. IMPEL și rețelele sale partenere recomandă cu tărie ca persoanele/organizațiile interesate să aplice tehnologia în practică să apeleze la serviciile unor profesioniști cu experiență în domeniul mediului.

Marco Falconi - IMPEL

Dietmar Müller Grabherr - FORUM COMUN privind terenurile contaminate din Europa

Frank Swartjes - EEA EIONET WG Contaminare

Tomas Albergaria - NICOLE

## Definiții

TERMEN	DEFINIȚIE	SURSĂ	PARAGRAF
'punct de conformitate'	locul (de exemplu, solul sau apele subterane) în care se măsoară criteriile de evaluare și nu trebuie să fie depășite	ISO EN 11074	3.4.5
'controlul conformității sau al performanței'	investigație sau program de inspecție, testare sau monitorizare continuă pentru a confirma că o strategie de remediere a fost implementată în mod corespunzător (de exemplu, toți contaminanții au fost eliminați) și/sau, atunci când a fost adoptată o abordare de izolare, că aceasta continuă să funcționeze la nivelul specificat	ISO EN 11074	6.1.5
'contaminant' <sup>1</sup>	substanța (substanțele) sau agentul (agenții) prezent(e) în sol ca urmare a activității umane	ISO EN 11074	3.4.6
'situl contaminat' <sup>2</sup>	situl în care este prezentă contaminarea	ISO EN 11074	2.3.5
'contaminarea'	substanța (substanțele) sau agentul (agenții) prezent(e) în sol ca urmare a activității umane	ISO EN 11074	2.3.6
'eficientă' <sup>3</sup>	<metodă de remediere> măsoară a capacității unei metode de remediere de a atinge o performanță necesară	ISO EN 11074	6.1.6
'emisie'	eliberarea directă sau indirectă de substanțe, vibrații, căldură sau zgomot din surse individuale sau difuze din cadrul instalației în aer, apă sau sol	IED	Art. 3 (4)
'standardul de calitate a mediului'	setul de cerințe care trebuie să fie îndeplinite la un moment dat de un anumit mediu sau de o anumită parte a acestuia, astfel cum sunt stabilite în dreptul Uniunii	IED	Art. 3 (6)
'Coeficientul lui Henry'	coeficientul de partiție între aerul din sol și apa din sol	ISO EN 11074	3.3.12
'metoda de tratare <i>in situ</i> ' <sup>4</sup>	metodă de tratare aplicată direct pe mediul tratat (de exemplu, sol, apă subterană) fără extragerea matricei contaminate din sol	ISO EN 11074	6.2.3
'levigare'	dizolvarea și deplasarea substanțelor dizolvate de către apă	ISO EN 11074	3.3.15

<sup>1</sup> În această definiție nu se presupune că din prezența contaminării rezultă prejudicii.

<sup>2</sup> În această definiție nu se presupune că din prezența contaminării rezultă prejudicii.

<sup>3</sup> În cazul unei metode bazate pe proces, eficacitatea poate fi exprimată în termeni de concentrații reziduale de contaminanți obținute.

<sup>4</sup> Notă: ISO CD 241212 propune ca sinonim: "tehnică (de remediere) in situ" [Notă 1: O astfel de instalație de remediere este amplasată la fața locului, iar acțiunea de tratare a contaminantului este menită să fie aplicată direct pe subsol..] ISO CD 24212 3.1

'poluant'	substanță(e) sau agent prezent în sol (sau în apele subterane) care, datorită proprietăților, cantității sau concentrației sale, provoacă efecte negative asupra funcțiilor solului	ISO EN 11074	3.4.18
'poluare'	introducerea directă sau indirectă, ca urmare a activității umane, de substanțe, vibrații, căldură sau zgomot în aer, apă sau sol care pot fi dăunătoare pentru sănătatea umană sau calitatea mediului, pot provoca daune bunurilor materiale sau pot afecta sau interfera cu facilitățile și alte utilizări legitime ale mediului	IED	Art. 3 (2)
'obiectiv de remediere'	termen generic pentru orice obiectiv, inclusiv cele legate de cerințele tehnice (de exemplu, concentrații reziduale de contaminant, performanțe inginerești), administrative și juridice	ISO EN 11074	6.1.19
'strategia de remediere'	combinație de metode de remediere și de lucrări asociate care vor îndeplini obiectivele specifice legate de contaminare (de exemplu, concentrațiile reziduale de contaminanți) și alte obiective (de exemplu, legate de inginerie) și vor depăși constrângerile specifice ale amplasamentului	ISO EN 11074	6.1.20
'valoarea țintă de remediere'	indicarea performanței care trebuie obținută prin remediere, de obicei definită ca obiectiv legat de contaminare în termeni de concentrație reziduală	ISO EN 11074	6.1.21
'zonă saturată'	zonă a solului în care spațiul poros este complet umplut cu lichid la momentul considerat	ISO EN 11074	3.2.6
'sol'	stratul superior al scoarței terestre situat între roca de bază și suprafață. Solul este compus din particule minerale, materie organică, apă, aer și organisme vii;	IED	Art. 3 (21)
'gaze din sol'	gaz și vapori în spațiile poroase ale solului	ISO EN 11074	2.1.13
'zonă nesaturată'	zonă a solului în care spațiul poros nu este complet umplut cu lichid la momentul considerat.	ISO EN 11074	3.2.8

<sup>5</sup> Alegerea metodelor ar putea fi constrânsă de o serie de factori specifici locului, cum ar fi topografia, geologia, hidrogeologia, propensiunea la inundații și clima.

# CUPRINS

---

<b>1</b>	<b>INTRODUCERE</b>	<b>10</b>
1.1	Contextul SVE	10
1.2	Aplicabilitatea SVE	10
1.3	Implementarea SVE	11
<b>2</b>	<b>DESCRIEREA TEHNICII</b>	<b>12</b>
2.1	Descrierea generală a procesului	12
2.2	Sistemul tehnic și componentele acestuia	12
2.3	Tratabilitatea contaminanților	13
2.4	Analizarea cadrului geologic	13
2.5	Considerații privind proiectarea sistemului	14
<b>3</b>	<b>STUDIUL DE FEZABILITATE</b>	<b>18</b>
3.1	Condițiile și modelul conceptual caracteristic sitului	18
3.1.1	Natura și gradul de contaminare	19
3.1.2	Caracteristicile geometrice ale sursei de poluare	20
3.1.3	Prezența NAPL	21
3.1.4	Rezultate obținute prin studiul gazelor de sol	21
3.1.5	Permeabilitatea la aer	21
3.1.6	Eterogenitatea și căile preferențiale	21
3.1.7	Topografia	22
3.2	Utilizări ale testelor de laborator în proiectarea remedierii SVE	22
3.3	Analiza fezabilității SVE	25
<b>4</b>	<b>TESTELE DIN TEREN</b>	<b>27</b>
4.1	Testul pilot convențional	29
4.1.1	Echipament convențional pentru testele pilot	31
4.1.2	Testul SVE de creștere a vidului în trepte	32
4.1.3	Testul SVE de vid constant	34
4.2	Testul de distribuție și recuperare a heliului	35
4.3	MONITORIZAREA GAZULUI DIN SOL	37
4.4	ECHIPAMENTE MINIME PENTRU TESTAREA SVE PE TEREN	38
4.5	SONDA DE EXTRAȚIE	38
4.6	PROPUNERE DE TESTARE PILOT – CERINȚE MINIME	39
4.7	ALTERNATIVĂ LA TESTAREA PILOT	40



<b>5</b>	<b>MONITORIZAREA PERFORMANȚEI</b>	<b>41</b>
5.1	Monitorizarea fazei operaționale	41
5.1.1	Parametrii chimici	41
5.1.2	Parametrii fizici	41
5.1.3	Meteorologie	42
5.2	Confirmarea curățării și închiderii sistemului	43
5.2.1	Posibile linii de dovezi care trebuie luate în considerare pentru confirmarea curățării	43
5.2.2	Procedura de eșantionare propusă pentru încheiere	45
<b>6</b>	<b>CONCLUZII</b>	<b>46</b>
6.1	EFICIENȚĂ, AVANTAJE ȘI DEZAVANTAJE	46
6.1	Control operațional pentru aplicarea SVE	47
	<b>BIBLIOGRAFIE</b>	<b>48</b>

## 1 INTRODUCERE

Rețeaua IMPEL, Rețeaua Uniunii Europene pentru implementarea și aplicarea legislației de mediu, elaborează, în cadrul proiectului WLR (Water and Land Remediation), o serie de ghiduri care se concentrează pe cele mai comune și mai utilizate tehnologii de remediere a solului și a apelor subterane. Aceste ghiduri sintetizează cele mai recente și mai actualizate informații privind aceste tehnologii de remediere, care ar putea ajuta părțile interesate distincte, cum ar fi proprietarii de situri, comunitatea locală, managerii de proiect, antreprenorii, autoritățile de reglementare și alte părți interesate să înțeleagă toate informațiile care emană din fiecare proiect de remediere. Sunt utilizate informații furnizate de către colaboratorii implicați, obținute din surse științifice evaluate de colegi și din diverse rapoarte oficiale.

Ghidul în cauză compilează cele mai recente cunoștințe despre una dintre cele mai frecvent utilizate tehnologii de remediere, extracția vaporilor din sol – *Soil Vapour Extraction* (SVE).

### 1.1 Contextul SVE

Extracția vaporilor din sol (tehnologii conexe, cum ar fi ventilația solului, ventilația solului *in situ*, extracția în vid din sol sau extracția în vid) este una dintre cele mai utilizate tehnologii de remediere a solului [FRTR 2020]. Datorită utilizării sale pe scară largă în ultimele decenii, SVE este, în prezent, o tehnologie unanim acceptată, clară și eficientă pentru remedierea solurilor contaminate cu compuși organici volatili (COV) (sau semi-volatili SCOV, specifici fiecărui sit) în zona nesaturată (sau vadoasă) a solului [Suthersan 1999].

O schemă tipică a unui proces SVE este prezentată în figura 1.1. SVE se folosește de volatilitatea ridicată a contaminanților pentru a-i transporta cu ajutorul unui flux de aer creat în sol prin inducerea unor condiții de vid generate de suflante/pompe. Această mișcare de aer/vapori transportă contaminanții către sonde de extracție, care îi transferă către sisteme de tratare a gazelor reziduale situate la suprafața solului, unde sunt recuperați sau tratați în mod corespunzător. Cele mai frecvente mecanisme de tratare sunt adsorbția pe cărbune activ și distrugerea prin oxidare catalitică sau termică [EPA 2018, Soares 2012].

SVE este o tehnologie de remediere versatilă și poate fi aplicată singură, concentrându-se exclusiv pe volatilizarea și recuperarea contaminanților, sau poate fi combinată cu alte tehnologii de remediere care introduc alte mecanisme de eliminare a contaminanților, cum ar fi biodegradarea (Ex.: Solul sau *bio-venting* și Aerul, sau *bio-sparging*, atunci când sunt aplicate în zonele nesaturate și saturate) sau desorbția (SVE îmbunătățită termic, care utilizează procese de încălzire precum rezistența electrică sau injectarea de aer cald/vapori pentru a crește rata de volatilizare a contaminanților și a facilita extracția). Fluxul de aer/vapori pe care SVE îl creează în zona nesaturată a solului favorizează volatilizarea contaminanților, sporind mobilitatea acestora în sol; și îmbunătățește transportul contaminanților volatili către sondele de extracție [Suthersan 1999, EPA 2018]. Debitul mai mic de aer/vapori, cum sunt cele utilizate de obicei în cazul ventilației solului, susțin biodegradarea compușilor degradabili prin aerarea metricii de sol.

### 1.2 Aplicabilitatea SVE

În funcție de proprietățile sitului, SVE este în general eficientă pentru solurile permeabile cu conținuturi scăzute/moderate de materie organică și umiditate și cu adâncimi ale apelor subterane cuprinse între 2 și 30 m.

Având în vedere tipul de contaminanți, SVE și-a demonstrat eficiența pentru compușii organici volatili halogenați și nehalogenați (COV), o eficiență limitată pentru compușii organici semivolatili halogenați și nehalogenați (SVOC), unii contaminanți emergenți (nu pentru 1,4-dioxan sau substanțe per- și

polifluoroalchilice (PFAS)) și combustibili; și nu se aplică contaminanților anorganici, radionuclizilor și munițiilor [FRTR 2020, EPA 2018].



Figura 1.1- Schema SVE.

### 1.3 Implementarea SVE

Punerea în aplicare a unui sistem SVE pentru remedierea unui sit contaminat necesită utilizarea unor suflante/pompe de vid, instalarea unor sonde de extracție (verticale sau orizontale) și a conductelor de transfer respective, care vor fi responsabile de extragerea contaminantului din sol la suprafață pentru tratarea ulterioară. Tratarea fluxului de aer contaminat va necesita proiectarea/construcția/autorizațiile instalațiilor și a echipamentelor adecvate pentru a îndeplini obiectivele de tratare a emisiilor, în vederea respectării reglementărilor naționale/regionale. Având în vedere experiența de operare și întreținere a SVE, eficiența acestuia arată în general un interval de 1 până la 3 ani [FRTR 2020].

## 2 DESCRIEREA TEHNICII

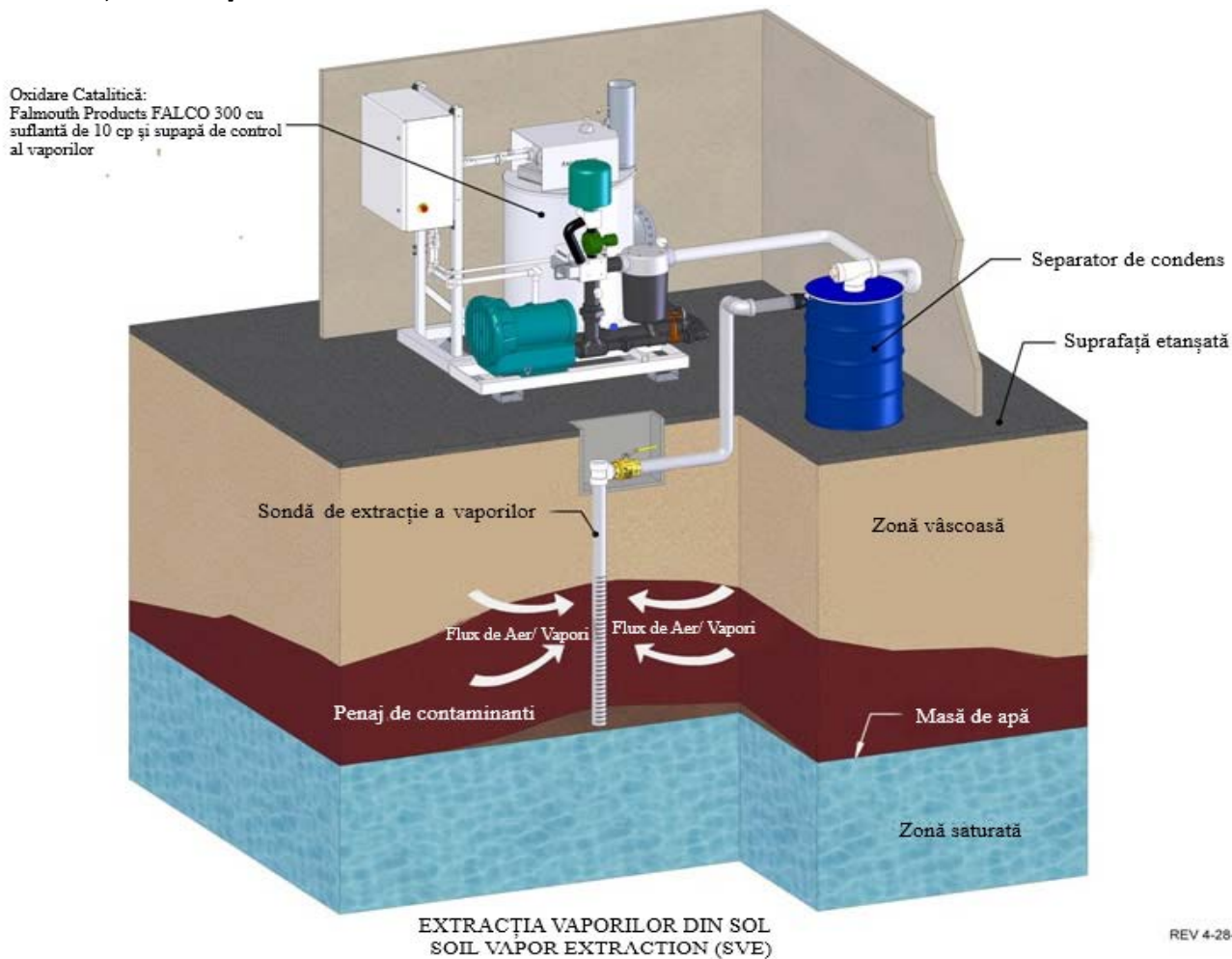
### 2.1 Descrierea generală a procesului

Extracția vaporilor din sol (Soil Vapour Extraction - SVE) este o tehnică de remediere *in situ* a solurilor contaminate din zona nesaturată. Aceasta se bazează pe extragerea contaminanților volatili prin ventilarea (sau depresurizarea) acestei zone. Condiția prealabilă pentru o aplicare reușită este o permeabilitate suficientă a solului.

SVE poate fi realizată cu sau fără injectare de aer. În cazul în care nu există o injectare activă de aer, aerul proaspăt pătrunde în sol din atmosferă pe la suprafața acestuia. Circulația aerului modifică echilibrul chimic dintre diferitele faze (gaz, apă poroasă, particule de sol), favorizând volatilizarea contaminanților volatili din fazele solide și/sau lichide. Vaporii extrași sunt supuși unui proces de tratare a gazelor reziduale.

Întregul proces trebuie să fie controlat și gestionat printr-un sistem de monitorizare completă (Ex.: debitul de aer, concentrația de contaminanți, temperatura, umiditatea).

### 2.2 Sistemul tehnic și componentele acestuia

Sistemul de ventilație care va fi amplasat la fața locului constă din următoarele echipamente:

- sonde de extracție verticale (sau orizontale) (denumite "drenări de extracție") pentru a avea acces la stratul de sol contaminat
- sonde (sau puncte) de injectare verticale (sau orizontale) pentru a spori/controla fluxul de aer în zona care urmează să fie reabilitată și, în special, la liniile de delimitare a sitului, cu supape (și debitmetre) pentru a conecta toate componentele sistemului
- un separator de condens sau un demister pentru a proteja sistemul de curățare împotriva umezelii și a apelor subterane mobilizate de fluxul de aer condus
- un ventilator/unitate de vid (pentru a genera presiunea negativă necesară inducerii fluxului de vapori din sol spre sondele de extracție)
- un sistem de tratare a gazelor reziduale (pentru a elimina contaminanții din vaporii extrași din sol).

Cele mai frecvente mecanisme de remediere sunt adsorbția pe cărbune activ și distrugerea prin oxidare catalitică sau termică. O schemă tipică a unui sistem SVE și a componentelor sale este prezentată în figura 2.1. Având în vedere că substanțele inflamabile (Ex.: benzina) sunt contaminanți de interes, este esențial să se elaboreze un plan de sănătate și siguranță și, de asemenea, să fie luate în considerare restricții privind tehnologiile de tratare a gazelor reziduale.



Figura 2.1- Componentele instalației SVE

### 2.3 Tratabilitatea contaminanților

A fost dovedită eficiența aplicării tehnicii SVE pentru remedierea solurilor nesaturate contaminate cu compuși organici volatili (COV). În funcție de locul de amplasare și/sau în combinație cu alte tehnologii, se poate aplica și pentru compuși organici semivolatili (SVOC). În general, este necesar ca acești contaminanți să nu fie puternic adsorbiți pe faza solidă a straturilor de sol.

Se aplică în general pentru compuși aromatici(BTEX), fenoli, benzină, HC <12, solvenți clorurați (cloroform, VC, DCM, DCA, DCE, TCA, TCE, TC, PCE) și clorobenzeni (cu substituție redusă). Prin urmare, SVE se aplică adesea în siturile petrochimice, benzinăriile, atelierele/industriile de prelucrare a metalelor și de prelucrare a metalelor (degresare și curățare uscată).

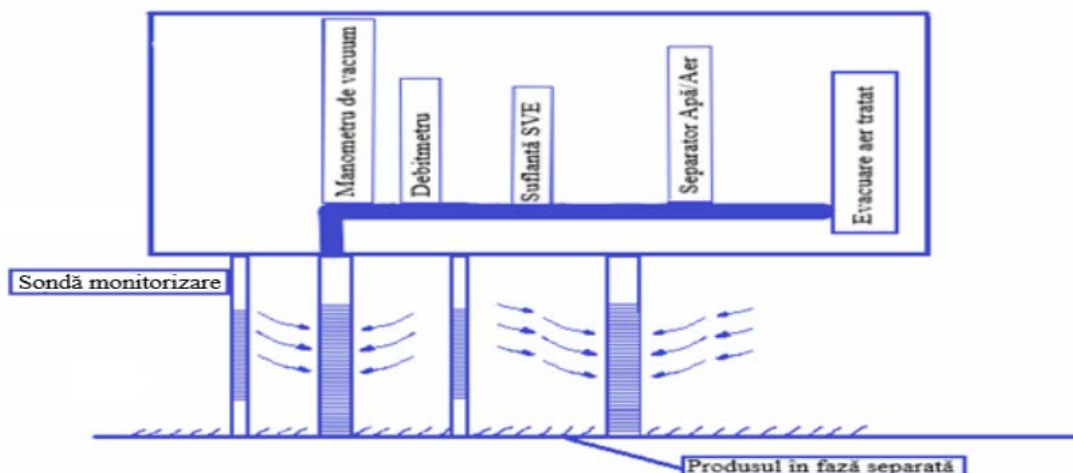
Factorii determinanți în aplicarea SVE sunt proprietățile contaminanților, în special partiția între faze și cadrul geologic al sitului, în special stratigrafia și proprietățile straturilor geologice, cum ar fi permeabilitatea, porozitatea și eterogenitatea.

Unele caracteristici ale contaminanților sunt foarte importante pentru eficiența procesului. Presiunea de vapori a unui compus este presiunea parțială a compusului respectiv în echilibru cu lichidul său (NAPL), prin urmare ea reprezintă o măsură a echilibrului dintre lichid și vapori L-V. Tehnica SVE este potrivită pentru substanțele cu o presiune de vapori > 0,5-1,0 mmHg. Punctul de fierbere este legat de presiunea de vapori și determină aplicabilitatea sau nu a SVE, care este adecvată pentru substanțele cu un punct de fierbere sub 250-300° C. Constanta lui Henry reprezintă raportul dintre concentrația unei anumite substanțe în faza gazoasă și a aceleiași substanțe în faza apoasă. Astfel, SVE este potrivită pentru substanțele cu constanta lui Henry > 0,001 atm m<sup>3</sup>/mol.

### 2.4 Analizarea cadrului geologic

Geologia, stratigrafia straturilor de sol și proprietățile straturilor de sol sunt foarte importante pentru eficiența aplicării tehnicii SVE. Prin urmare, este esențial să se înțeleagă cadrul geologic al sitului pentru a dezvolta un model conceptual coerent aplicabil sitului în speță (a se vedea capitolul 3.1).

Printre proprietățile solului, parametrii cheie sunt porozitatea, permeabilitatea, conținutul de apă (poroasă) și eterogenitatea. Fluxul de aer din straturile de sol se produce prin spațiile poroase din sol care sunt

interconectate, astfel, o porozitate mai mare crește fluxul de aer prin sol. Prezența apei în pori este un obstacol fizic care împiedică fluxul de aer. Pe de altă parte, un conținut foarte scăzut de umiditate determină o adsorbție mai puternică a unor contaminanți pe fracțiunea uscată a solului.

Prezența unor zone caracterizate de texturi și permeabilități semnificativ diferite poate să afecteze fluxul de aer și, astfel, să afecteze proiectul de remediere prin provocarea unor întreruperi de circuit (Ex.: fluxuri de aer preferențiale în zonele de neomogenitate sau în apropierea sondei de aspirație). Un alt factor important care ar putea limita fluxul de aer este nivelul pânzei freatice. Depresurizarea indusă la sondele de extracție poate provoca o creștere a nivelului piezometric (o depresurizare de 0,2 atm ar induce o creștere de aproximativ 2 m) și inunda parțial sondele și sistemul SVE. Se presupune că o situație favorabilă aplicării SVE constă dintr-o adâncime de aproximativ 3 m până la pânza freatică, la adâncimi mai mici de 1,5 m nefiind recomandabil de aplicat această tehnică.

De asemenea, un conținut ridicat de carbon organic în sol (SOC) (Ex.: turbă) poate împiedica funcționarea SVE. (În raport cu SOC, desorbția și volatilizarea devin din ce în ce mai limitate și, mai mult, permeabilitatea va scădea substanțial).

Parametrii prezentați mai jos ar putea fi cheia unei aplicări cu succes a tehnicii SVE:

- permeabilitatea ridicată a straturilor geologice ;
- compoziția omogenă a solului, adică absența straturilor și a lentilelor cu textură diferită, absența căilor preferențiale de curgere a aerului rezultate din prezența infrastructurii subterane;
- absența lentilelor sau a straturilor de turbă cu capacitate mare de adsorbție a contaminanților organici;
- absența unor acumulări de contaminanți captivi;
- absența acoperirii impermeabile a straturilor relativ puțin permeabile;
- absența apelor subterane de mică adâncime.

## 2.5 Considerații privind proiectarea sistemului

Proiectarea SVE constă în definirea:

a) Parametrilor de funcționare ai sistemului:

- Vitezei de extragere a aerului
- Gradului de vid la puțul de extracție
- Razei de influență (ROI)

b) Definirea componentelor sistemului:

- Numărul sondelor de extracție și poziționarea acestora
- Construirea sondelor
- Ventilator de extracție
- Separator apă-aer
- Unitatea de tratare a vaporilor (cu schimbător de căldură)

Se efectuează teste pilot în vederea proiectării SVE. Aceste teste trebuie să includă cel puțin 1 sondă de extracție și cel puțin 3 puncte de monitorizare (eventual multi-nivel în cazul unui sit eterogen) în care se măsoară vidul atins. Pentru un test pilot util este necesară reglarea debitului de extracție acționând asupra

supapei de reglare prevăzute în mod normal pe conducta de admisie. Pentru fiecare poziție a supapei (corespunzătoare unui anumit debit de extracție), trebuie așteptate aproximativ 30 de minute pentru stabilizarea sistemului și apoi măsurate:

- Gradul de vid la sonda de extracție;
- Gradul de vid indus la punctele de monitorizare;
- Debitul aerului extras;
- Compoziția și temperatura gazului extras.

Măsurătorile se repetă pentru diferite grade de deschidere a supapei. Permeabilitatea intrinsecă a solului (k) poate fi estimată cu măsurători efectuate pe durata testului pilot.

Unul dintre cele mai importante criterii de proiectare este raza de influență, care se bazează pe măsurătorile colectate în timpul testului pilot. În absența unei baze de date obținute din situații concludente, aceasta este cea mai fiabilă metodă de proiectare a unei intervenții de remediere la scară largă.



Figura 2.4- Raza de influență

Odată ce raza de influență a fost definită, se trasează o serie de cercuri cu o rază egală cu cea a razei de influență, asigurând o suprapunere parțială, pentru a evita zonele care nu sunt tratate suficient.

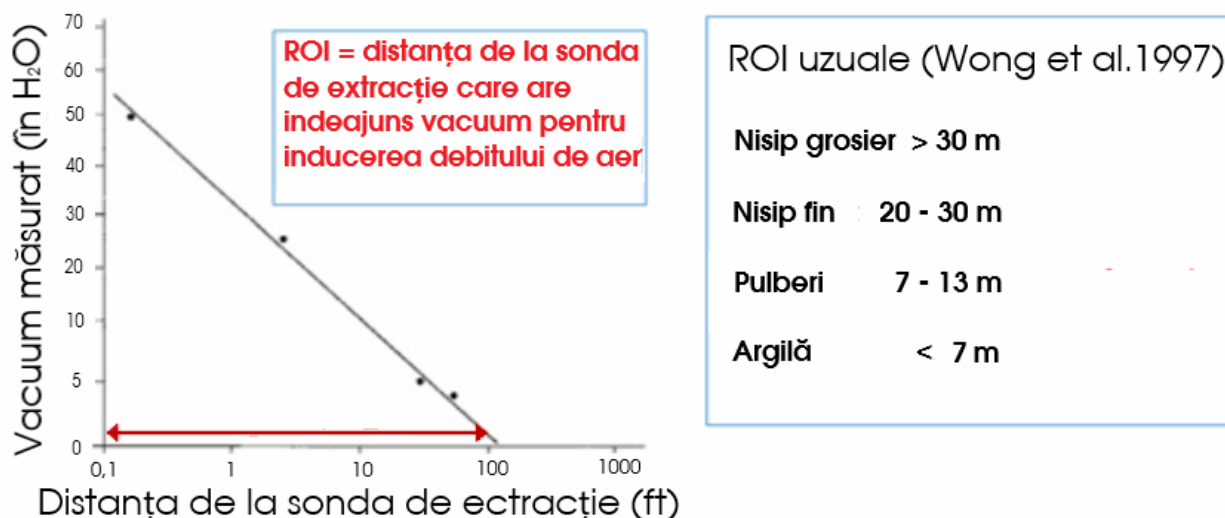
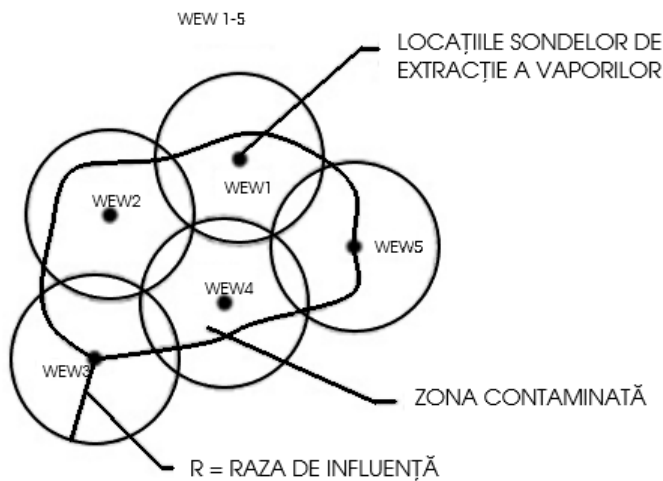

Numărul sondei

$$n^{\circ} = \frac{1,3 \cdot A}{\pi \cdot ROI^2}$$

A = Aria contaminată (m<sup>2</sup>)  
 ROI = Raza de influență (m)  
 1,3 = factor de creștere pentru zonele de influență care se suprapun

Figura 2.5- Numărul de foraje

Odată ce a fost definită adâncimea ferestrei (în general egală cu adâncimea contaminării) și fiind cunoscută raza de influență asociată cu vidul, este posibil să se stabilească ratele de extracție a aerului.

**EXTRACTION RATES**

$$\frac{Q}{H} = \pi \frac{k}{\mu} P_w \left[ \frac{1 - \left(\frac{P_{atm}}{P_w}\right)^2}{\ln\left(\frac{R_w}{R_i}\right)} \right]$$

H = lungimea de fenestrare (m)  
 k = permeabilitatea intrinsecă (m<sup>2</sup>)  
 P<sub>w</sub> = presiunea în sondă (g/cm/s<sup>2</sup>)  
 P<sub>atm</sub> = presiunea atmosferică (g/cm/s<sup>2</sup>)  
 R<sub>w</sub> = raza sondei de extracție (cm)  
 R<sub>i</sub> = raza de influență (cm)  
 Q = fluxul de aer din sondă (cm<sup>3</sup>/s)



Figura 2.6 Ratele de extracție

Valorile tipice de proiectare pentru rata de extracție din studiile pilot și din aplicații sunt de 20-200 m<sup>3</sup>/h; valorile tipice de proiectare pentru depresurizarea la sonda inițială din studiile pilot și din aplicații sunt de 0,5-1 atm.

Vaporii extrași sunt supuși unor tratamente diferite în funcție de concentrația lor. În ceea ce privește substanțele inflamabile considerate contaminanți problematici, cel mai important parametru este limita inferioară de explozivitate (LEL). Se poate aplica tehnicile de adsorbție pe cărbune activ și oxidare catalitică dacă

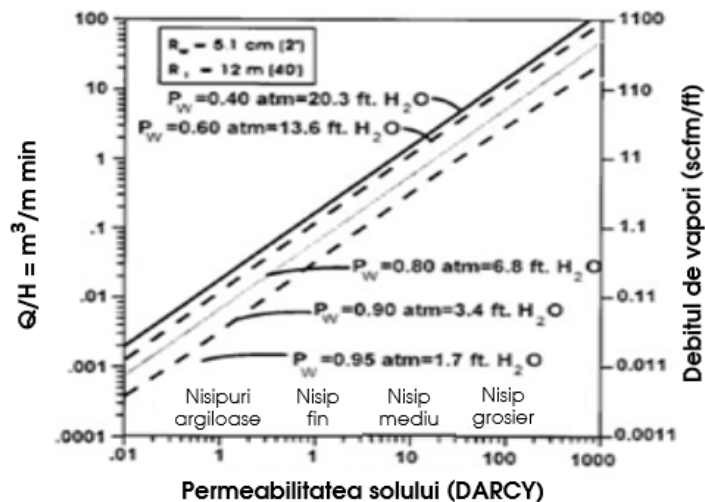

C (vapori) <25% LEL, tehnica de oxidare termică este recomandată dacă C (vapori) <25-50% LEL, în timp ce biofiltrele este recomandat a fi utilizate în situația în care C (vapori) <10% LEL.

### 3 STUDIUL DE FEZABILITATE

Criteriile principale pentru selectarea acestei tehnologii sunt permeabilitatea la aer a mediului poros și volatilitatea contaminanților. Apoi, tehnica ar trebui apoi să fie analizată ținând cont de o serie de factori specifici pentru fiecare sit.

#### 3.1 Condițiile și modelul conceptual caracteristic sitului

O serie de condiții fizico-chimice ale sitului au un impact semnificativ asupra eficienței SVE ca alternativă de remediere. Acești parametri sunt discutați în secțiunile de mai jos, împreună cu datele relevante care ar trebui colectate pentru caracterizarea fezabilă a sitului și pentru proiectarea SVE.

Astfel, Figura 3.1 prezintă aceste date de caracterizare a sitului. Este esențială importanța colectării datelor relevante cât mai devreme posibil. Deși înțelegerea situației sitului nu va fi niciodată perfectă (deoarece instrumentele de caracterizare, resursele financiare și metodele de eșantionare au limitări practice), există obligația de a colecta cât mai multe informații care converg către conturarea unei imagini coerentă a sitului. Această imagine sau model conceptual al sitului este în mod necesar multi-fațetată și multi-disciplinară, cuprinzând o varietate mare de tipuri de date. De asemenea, modelul este dinamic - în sensul că evoluează pe măsură ce sunt disponibile date suplimentare. De aceea este important să se revizuiască în mod continuu modelul conceptual al sitului, pe măsură eforturile din teren furnizează noi informații.

Modelul conceptual al sitului ar trebui să pornească de la o descriere (hidro)geologică a sitului și să caracterizeze sursa (sursele) primară (primare) de contaminare, masa de contaminant eliberat, modelul de eliberare și, în special, extinderea verticală și orizontală a distribuției contaminantului/lor în zona vadoasă. Există o serie de aspecte-cheie în ceea ce privește caracterizarea zonei vadoase pentru extracția vaporilor de sol. Pe scurt, acestea includ:

- tipul acoperirii suprafeței (Ex.: asfalt, vegetație);
- prezența și extinderea structurilor sau a utilităților îngropate;
- topografia;
- distribuția și adâncimea fiecărui tip de sol;
- adâncimea pânzei freatice și fluctuația sezonieră a acesteia;
- conținutul și variabilitatea umidității solului;
- grosimea capilarelor;
- permeabilitatea aerului și modul în care aceasta variază în domeniul de interes;
- conținutul și variabilitatea carbonului organic total.

Oricare (sau o combinație) dintre aceste elemente cheie ale sitului poate influența puternic eficiența SVE și/sau poate reprezenta o limitare serioasă a SVE. Adesea, datele de caracterizare a sitului care pot fi importante pentru aplicarea tehnologiilor SVE nu sunt colectate, deoarece cei responsabili de realizarea forajelor și a sondelor de observație fie nu sunt conștienți de acestea, fie nu sunt îndemnați să le recunoască și să le înregistreze în mod sistematic.

Înțelegerea naturii orizonturilor de suprafață este esențială. Ar trebui să se înregistreze indicii ale caracteristicilor subsolului, cum ar fi lentilele de nisip sau pietriș într-o matrice cu textură mai fină, sau macroporii, care ar putea servi drept căi preferențiale de curgere a aerului. Culorile și pestrițările solului pot oferi o indicație a zonei în care nivelul freatic fluctuează în mod sezonier. În locațiile urbane sau industriale, contactul dintre solul/încărcătura deranjat(ă) și solul nativ ar trebui să fie distins, dacă este posibil. Metodele standard de caracterizare a solului ar trebui să fie utilizate în aceste scopuri de către persoane instruite în utilizarea lor (Breckenridge, Williams și Keck 1991; USEPA 1991h).

Parametru	Metoda de prelevare	Metoda de analiză
Permeabilitate în aer	Testul pompei pneumatice	Vezi Cho si DiGiulio (1992)
Permeabilitate în aer (scara de bază)	eșantioane de sol în situ sau nedisturbate, cu diametrul de 50-75 mm, tipice pentru tipul de sol	Vezi paragraful 4-2d si Appendix D; Corey (1986a)
Stratigrafie/heterogenitate	Forajul solului și/sau groapa de testare	Observații vizuale; Breckenridge, Williams and Keck(1991);USEPA(1991h)
Dimensiune granulară	Lingură despicată sau altă probă de sol	ASTM D422-63 (1998)
Porozitate	Eșantion de sol nedisturbat cu diametrul de 50 - 75 mm	Calculată din densitatea aparentă uscată și densitatea particulelor
Densitate aparentă uscată	Eșantion de sol nedisturbat cu diametrul de 50 - 75 mm	ASTM D2850
Continut de Carbon organic	Eșantion de lingură divizată	SW-846 9060;
Grad de umiditate (saturatie)	Înregistrarea netronilor prin tuburi de acces Tensiometre Eșantion de sol nedisturbat cu diametrul de 50 - 75 mm	Manometru neutronic (Gardner1986), ASTM D3017, ASTM D5220, Cassel and Klute (1986) ASTM D2216-92
Retenția umidității în sol (curba de saturație a presiunii capilare)	Eșantion de sol nedisturbat cu diametrul de 50 - 75 mm	Klute (1986), ASDM D2325-93
Retenția umidității în solul uscat definitiv	Eșantion de sol nedisturbat cu diametrul de 50 - 75 mm	Metoda Psychrometer (Jones, Gee, and Heller 1980)
Temperatura Solului	Termometru, Termocuplu	Sistem portabil de măsurare
Adâncimea până la ape subterane respectiv variațiile de sezon	Sonde de monitorizare a nivelului freatic, contor al nivelului de apă	ASDM D4750
conținutul de hidrocarburi volatili în gazele din sol	La fața locului	Downey & Hall(1994), ASDM D3416-78
O <sub>2</sub> continut in gazele din sol	La fața locului	Sistem portabil de măsurare metoda celulei electrochimice
CO <sub>2</sub> continut in gazele din sol	La fața locului	Sistem portabil de măsurare metoda de adsorpție în infraroșu
Rata de respirație microbiană	La fața locului	Hinchee et. al. 1992

Figura 3.1- Prezentarea metodelor de testare și a celor analitice

### 3.1.1 Natura și gradul de contaminare

În scopul evaluării fezabilității SVE, timpul caracterizării sitului, trebuie determinate proprietățile chimice ale mediului sitului, precum și natura și amploarea contaminării. Contaminanții care se pretează cel mai bine la SVE sunt COV, care includ benzina, kerosenul, mulți constituenți ai combustibilului diesel, freonii și solvenți precum PCE, tricloroetanul și clorura de metilen.

Figura de mai jos prezintă diferite clase de contaminanți și clasifică gradul lor de sensibilitate la SVE.

	<b>Grupe Contaminante</b>	<b>Exemple de contaminanti</b>	<b>Eficacitate</b>
<b>Organice</b>	COV-uri Halogenate	Tracloretena, Tricloroetena	a
	COSV-uri Halogenate	Para - diclorobenzen	b
	COV-uri Nonhalogenate	Benzină	a
	COSV-uri Nonhalogenate	Motorină	a
	PCB-uri	Aroclor - 1242	c
	Pesticide	Clordan	c
	Dioxine/Furani	2,3,7,8-traclorodibenzeno-p-dioxină	c
	Cianuri Organice		c
	Corozivi Organici		c
	<b>Inorganice</b>	Explozibili	2,4,6 - Trinitrotoluen
Metale volatile		Mercur, plumb tetraetil	c
Metale non volatile		Nichel, Crom	c
Azbest			c
Materiale radioactive			c
Corozivi inorganici			c
Cianuri inorganice		Cianura de sodiu	c
<b>Reactanti</b>		Oxidanti	
	Reductori		b

Figura 3.2- Eficiența SVE asupra grupurilor de contaminanți

### 3.1.2 Caracteristicile geometrice ale sursei de poluare

- Pentru a selecta tehnologiile adecvate, trebuie să fie determinat gradul de contaminare în trei dimensiuni în timpul fazei de caracterizare a sitului. În ceea ce privește SVE, trebuie caracterizate atât zona nesaturată, cât și zona saturată.
- Adâncimea contaminării afectează fezabilitatea și proiectarea sistemelor SVE. În cazul în care contaminarea este limitată la suprafața solului, este recomandabil a se aplica alte tehnologii decât SVE. De asemenea, în cazul în care contaminarea este localizată la adâncime în zona saturată, SVE singur nu va fi fezabil. În siturile în care SVE este fezabil, adâncimea contaminării va determina tipul de sondă (orizontală sau verticală), intervalul de filtrare a sondei, precum și alți factori de proiectare.
- Volumul de sol contaminat are un impact semnificativ asupra fezabilității SVE. În cazul în care volumul este mic, alte alternative (cum ar fi excavarea și eliminarea în afara sitului) pot fi mai eficiente din punct de vedere al costurilor. De asemenea, volumul de sol contaminat are un impact semnificativ asupra multor aspecte ale proiectării sistemului, el determinând: numărul de sonde, dimensiunea suflantelor și capacitatea sistemului de tratare a gazelor reziduale.
- Mai mult, trebuie luate în considerare la determinarea fezabilității și proiectării sistemelor SVE și sursele potențiale de contaminanți în fază de vapori din afara sitului. În cazul în care există posibilitatea ca o contaminare semnificativă a fazei de vapori să migreze din exteriorul sitului de interes către interiorul

acestui, în timpul aplicării SVE, proiectarea sistemului va trebui să includă sonde de injectare de aer sau alte mijloace de prevenire a acestui fenomen.

### 3.1.3 Prezența NAPL

Investigatorul sitului ar trebui să determine dacă sunt prezente și NAPL. Produsul liber în probele de apă subterană ar fi un indiciu al existenței NAPL. NAPL concurează cu aerul și umiditatea solului pentru spațiul poros din zona nesaturată, reducând permeabilitatea fazei aeriene. În plus, NAPL reprezintă o sursă continuă de contaminanți. Au fost raportate saturații reziduale în zona nesaturată cuprinse între 15 și 50 % din spațiul poros disponibil (USEPA 1989c).

În cazul în care se suspectează prezența DNAPL, ar putea apărea îngrijorări legate de faptul că implementarea SVE ar putea crește riscul de migrare a DNAPL în unitățile hidrologice de adâncime. De exemplu, acesta ar putea fi cazul în care DNAPL se află în roca de bază fracturată situată deasupra nivelului freatic. S-a observat că într-un astfel de mediu inducerea fluxului de aer către o sondă de extracție ar putea fi însoțită de un contracurent de DNAPL mai adânc în sistemul de fracturi și, probabil, în zona saturată. Astfel, s-ar putea depăși obstacolele tehnice de aplicabilitate a acestei tehnici (USEPA 1993g).

### 3.1.4 Rezultate obținute prin studiul gazelor de sol

Prin însăși natura lor, contaminanții care se pretează la SVE pot fi măsurați în timpul studiilor gazelor din sol. În mod frecvent, măsurarea gazelor din sol la fața locului este o modalitate utilă de a caracteriza natura și amploarea contaminării solului unui sit. Adesea, măsurătorile pe teren ale concentrațiilor de contaminanți gazoși din sol, confirmate de un număr limitat de analize de laborator, sunt suficiente pentru caracterizarea sitului. Cu toate acestea, rareori se poate obține o bună corelare cantitativă între gazele din sol și concentrațiile contaminanților din sol. Acest lucru este valabil în special atunci când sunt prezente concentrații mai mari de contaminanți din cauza NAPL reziduale. Atunci când se face o comparație între concentrațiile din gazele din sol și cele din probele de sol, este util să se țină cont de faptul că rezultatele probelor de sol reprezintă contaminanții din toate compartimentele solului, în timp ce gazele din sol îi măsoară doar pe cei aflați în fază de vapori. De asemenea, studiile privind gazele din sol pot oferi o imagine de ansamblu a concentrațiilor de contaminanți care pot fi așteptate inițial în gazele SVE.

### 3.1.5 Permeabilitatea la aer

Permeabilitatea la aer, respectiv capacitatea solului de a permite trecerea aerului, este unul dintre cei mai importanți parametri care afectează fezabilitatea și proiectarea SVE. Aceasta este o funcție a proprietăților matricei solide și a conținutului de umiditate. Permeabilitatea aerului are o influență profundă asupra debitelor de aer și a ratelor de recuperare a contaminanților. Solurile cu granulație grosieră prezintă, de obicei, valori mari ale permeabilității aerului și modele mai uniforme ale fluxului de aer. Solurile cu permeabilitate la aer mai mică de aproximativ  $10^{-10}$  cm<sup>2</sup> pot să nu se preteze la remedierea prin SVE (USEPA 1993d).

### 3.1.6 Eterogenitatea și căile preferențiale

Eterogenitatea joacă un rol semnificativ în distribuția contaminanților în zona nesaturată și este cauzată de variațiile spațiale ale tipurilor de sol, stratificării, porozității și conținutului de umiditate. În timpul funcționării unui sistem SVE, aceste variații pot influența modelele fluxului de aer și, în cele din urmă, ratele de recuperare a contaminanților în zona nesaturată. De exemplu, în cazul în care zona nesaturată este formată din straturi alternante de soluri cu granulație grosieră și fină, fluxul de aer poate fi restricționat la straturile cu granulație grosieră. Contaminanții sunt adesea eliminați din straturile cu granulație mai fină la viteze mult mai lente.

Forajele de sol, penetrometria conică și examinarea profilului solului pe fețele expuse ale gropilor de testare se numără printre metodele de obținere a informațiilor privind eterogenitățile fizice.

În unele cazuri, utilitățile subterane, cum ar fi canalizările pluviale și sanitare, sau materialul de umplutură asociat cu aceste caracteristici pot produce scurtcircuitarea fluxului de aer asociat unui sistem SVE. Ca urmare, fluxul de aer poate fi concentrat de-a lungul acestor caracteristici, mai degrabă decât în interiorul zonei care necesită tratament. În plus, aceste caracteristici pot oferi, de asemenea, căi de migrare atât pentru lichidele în fază liberă, cât și pentru vaporii din zona nesaturată. Prin urmare, orientarea și geometria acestor caracteristici pot dicta direcția în care migrează lichidele sau vaporii. Adesea, nu există desene exacte, așa cum au fost construite, ale utilităților subterane, astfel încât trebuie consultate și persoanele care cunosc bine locul. Trebuie să se ia în considerare subsolurile clădirilor din apropiere și alte caracteristici care pot afecta curgerea.

### 3.1.7 Topografia

Topografia și natura suprafeței solului vor afecta aplicabilitatea SVE. O suprafață impermeabilă va avea tendința de a spori fluxul de aer orizontal și de a mări raza de influență, în timp ce o suprafață permeabilă va avea efectul opus și va crește cantitatea de aer atmosferic care intră în subsol. Constrângerile de suprafață, cum ar fi clădirile, șoselele și sistemele de utilități, pot face din SVE o alternativă de remediere atractivă în raport cu alte opțiuni. În cazul în care la suprafața solului este prezent un pavaj, trebuie examinată integritatea acestuia. Trebuie observate fisurile și, dacă este posibil, trebuie sigilate.

## 3.2 Utilizări ale testelor de laborator în proiectarea remedierii SVE

Teste pe coloană pentru determinarea parametrilor de proiectare. Ball și Wolf (1990) recomandă testele în coloană în laborator pentru determinarea parametrilor de proiectare pentru sistemele SVE care se adresează unor contaminanți unici în soluri izotrope omogene în situri mici. Abordarea lor constă în umplerea unei coloane cu solul sitului, aplicarea unui flux de aer reprezentativ și măsurarea concentrațiilor de contaminanți din efluent în funcție de numărul de schimburi de volume de pori. O ecuație de descreștere exponențială este apoi ajustată la aceste date, iar parametrul de calibrare este utilizat într-o predicție la scară mai mare a ratei de emisie pentru sistemul SVE la scară reală. Cu aceste informații, se pot estima timpul și costul total de remediere a solului.

Teste pe coloană pentru a determina eficiența SVE. USEPA (1991c) recomandă testele în coloană pentru depistarea remediilor atunci când există îndoieli cu privire la eficiența SVE pe un sit. Această etapă poate fi omisă atunci când presiunea de vapori a compușilor țintă este de 10 mm Hg sau mai mare. Testele în coloană nu sunt, de asemenea, fezabile pentru siturile cu fundamentul de rocă fracturată sau cu umplutură eterogenă formată din bucăți mari de moloz.

Aceste studii au un cost relativ scăzut și presupun trecerea a aproximativ 2.000 de volume de aer prin coloană (pe parcursul a aproximativ 6 zile de funcționare). Trebuie remarcat faptul că această echivalență depinde de caracteristicile solului, cum ar fi permeabilitatea și conținutul de umiditate. De exemplu, într-un sol uscat și nisipos, volumele de 2.000 de pori pot fi eliminate în doar un an, în timp ce într-un sol argilos și umed poate necesita mai mult de 6 ani. Cu toate acestea, în cele mai multe cazuri, scenariile de curgere specifice locului s-ar încadra undeva între 3 și 6 ani. Motivul pentru efectuarea testelor în coloană este acela de a studia cinetica de difuzie a solului. S-a constatat că eliberarea contaminanților devine aproape întotdeauna limitată de difuzie în primele 1 000 de volume de pori, ceea ce indică faptul că echilibrul este atins relativ repede. Prin urmare, o perioadă de studiu cu un volum de 2.000 de pori permite cuantificarea cineticii de difuzie.

Concentrațiile de contaminanți gazoși din sol sunt monitorizate în timpul testului, iar o reducere de 80 % sau mai mult indică faptul că SVE este potențial viabil pentru sit și ar trebui să fie evaluat în continuare prin studii

suplimentare pe coloană. În cazul în care se obțin reduceri mai mari de 95 %, solul rezidual din coloană poate fi analizat pentru a cuantifica contaminarea reziduală. În cazul în care concentrațiile sunt sub obiectivele de curățare, testele în coloană pentru selectarea remediului pot fi omise și se pot efectua în continuare teste de permeabilitate la aer.

Testele pe coloană nu sunt necesare pentru majoritatea aplicațiilor SVE, dar pot fi utile în anumite circumstanțe, de exemplu, pentru ventilarea și/sau biodegradarea contaminanților recalcitranti (greu de degradat). Testele pe coloană utilizează în mod obișnuit între 2 și 8 kg de sol contaminat (de exemplu, cu dimensiuni ale coloanei cuprinse între 5 și 10 cm în diametru și între 30 și 60 cm în lungime) și sunt efectuate până când rezultatele devin asimptotice, durata și costul depinzând de caracteristicile solului și de contaminanți. Măsurătorile efectuate înainte de testele în coloană pot include densitatea aparentă, conținutul de umiditate și analizele concentrațiilor de contaminanți în matricea solului, în levigat și în spațiul de cap. Se pot testa diferite debite de aer pentru a verifica sensibilitatea ratelor de îndepărtare a contaminanților în funcție de debitul de aer. Măsurătorile efectuate în timpul testelor includ presiunile de intrare și de ieșire a aerului, concentrațiile de contaminanți din efluent, debitele de aer și temperatura. După test, se măsoară concentrațiile de contaminanți din matricea solului și din levigatul TCLP pentru a le compara cu obiectivele de curățare. O schiță a unui aparat de testare în coloană este prezentată în figura 3.3.



Figura 3.3- Diagrama unui aparat de testare pe coloană

Figura 3.4 prezintă avantajele și dezavantajele testelor în coloană. Deși, în general, nu trebuie să se apeleze la testele în coloană ca sursă unică de date privind permeabilitatea la aer, acestea pot constitui un mijloc util de a completa testele de permeabilitate la aer in situ.

De exemplu, în timp ce testele ca *in situ* pot fi efectuate, de obicei, doar într-un număr limitat de locații, carote intacte pot fi adesea colectate din mai multe locații și la mai multe adâncimi, inclusiv în cadrul locațiilor de testare ca *in situ*, astfel încât să poată fi determinată corelația dintre datele de laborator și cele *in situ*. În cazul

În care rezultatele sunt bine corelate, datele de laborator pot fi utilizate pentru a extrapola rezultatele *in situ* în întreaga zonă de eșantionare.

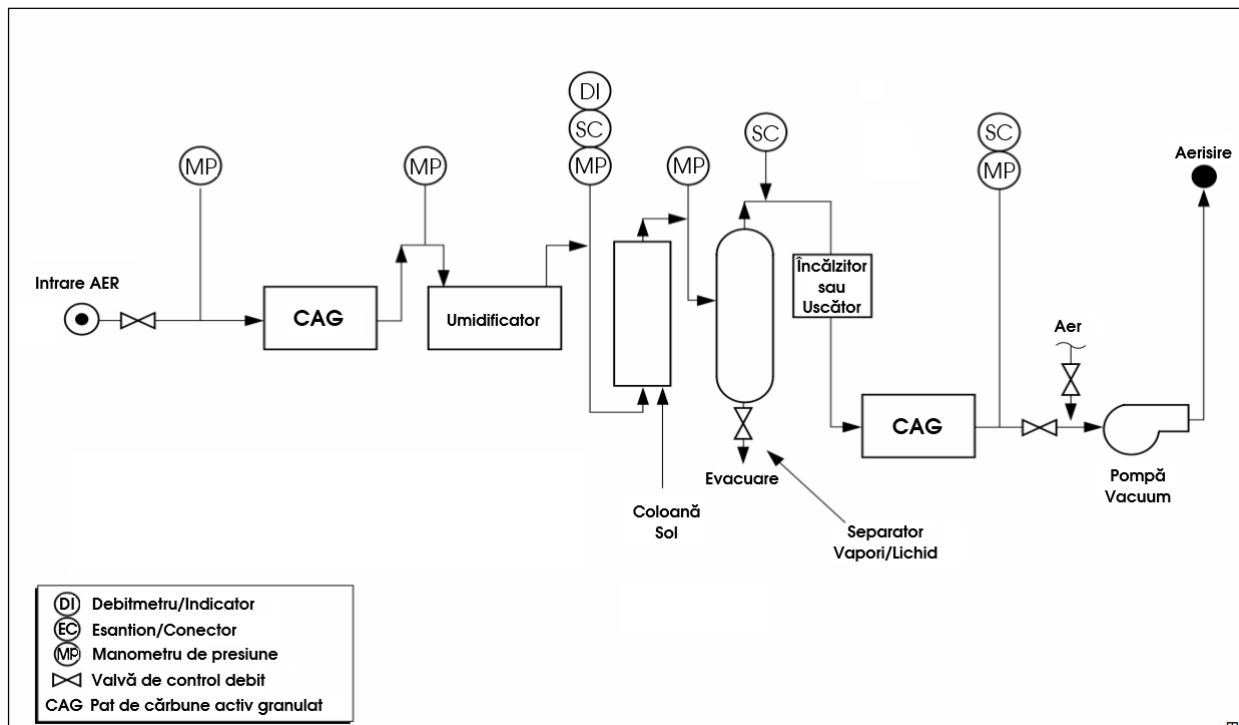
	Avantaje	Limite
1	Poate accelera procesul SVE pentru a permite evaluarea potențialului maxim de eliminare a contaminanților	1 Aerul de decapare are întotdeauna un bun acces la contaminanți în întreaga coloană. Debitul de aer către diferite zone variază foarte mult pe teren.
2	Oferă informații de ordin de mărime cu privire la coeficientul de partiție necesar pentru modelarea matematică	2 Procesele de difuzie sunt adesea modelate necorespunzător.
3	Se pot obține măsurători de ordin de mărime ale permeabilității la aer cu probe "nedisturbate".	3 Din cauza diferenței de scară și a fluxului de aer față de orientarea miezului, trebuie obținute rezultate mai reprezentative ale permeabilității aerului pe parcursul măsurătorilor de permeabilitate a aerului pe teren.
4	Poate permite analiza unor eșantioane foarte apropiate	4 Este necesară formularea de Proceduri standard și validarea acestora.

Figura 3.4- Testarea pe coloană – avantaje și limitări

Testele pe coloană se efectuează cel mai bine folosind eșantioane de carote intacte. Probele de carote intacte pot fi obținute cu ajutorul prelevatoarelor cu antrenare sau al dispozitivelor de carotaj continuu. Eșantioanele de carote trebuie să fie colectate în interiorul unor manșoane rigide și să fie notate cu denumirea și orientarea eșantionului. Eșantioanele trebuie sigilate și refrigerate în momentul prelevării pentru a preveni volatilizarea și degradarea contaminanților. Procedurile tipice de forare permit recuperarea carotelor de sol într-o orientare verticală sau aproape verticală. Fluxul tipic de aer în timpul SVE, deși cu siguranță tridimensional, nu este vertical, iar permeabilitatea orizontală a aerului este probabil mai interesantă. Acest fapt ar trebui să fie cântărit cu atenție atunci când se decide dacă se vor colecta carote verticale pentru testare.

La laborator, probele de carote pot fi extrudate în coloane de testare sau manșoanele de probă pot fi încorporate în configurația coloanei. Dacă au fost obținute probe deranjate, probele trebuie reambalate până la o densitate finală apropiată de condițiile de teren. În cazul în care testul este conceput pentru a simula curgerea verticală printr-un profil stratificat, straturile pot fi încorporate în timpul plasării solului. Ar trebui să se ia în considerare colectarea de carote intacte, orientate orizontal, dacă testul este destinat să simuleze fluxul de aer orizontal.

Echipamentul de testare include, de obicei, un sistem de alimentare cu vid sau cu aer, dispozitive de măsurare a debitului și echipamente de măsurare a presiunii. De asemenea, pot fi furnizate dispozitive de măsurare a umidității solului (de exemplu, tensiometre). Toate conexiunile dintre sistemul de alimentare cu aer, pereții coloanei și proba de sol trebuie să fie etanșe. Unele coloane încorporează un balon gonflabil în anvelopa dintre proba de carotaj și peretele coloanei pentru a preveni scurgerile de-a lungul laturilor probei de sol. Concentrațiile de contaminanți pot fi măsurate în fază solidă sau de vapori. Deoarece măsurătorile solului necesită o prelevare distructivă, punctele de măsurare sunt limitate la concentrațiile inițiale și finale. Prelevarea de probe de vapori permite măsurarea în timp a concentrațiilor efluenților, dar necesită, de obicei, echipamente de măsurare sofisticate la fața locului (de exemplu, cromatografe cu gaz). Măsurătorile de vapori trebuie să fie susținute de concentrațiile inițiale și finale din sol.

Rezultatele testelor sunt de obicei exprimate ca concentrație de contaminanți în raport cu volumul total de aer schimbat. Pentru a corela testele în coloană cu aplicațiile pe teren, schimbul de aer este de obicei exprimat în unități de volume de pori.

Calcularea volumelor de pori necesită măsurarea porozității și dimensiunilor probei, precum și a debitului și a timpului scurs. Rezultatele pot fi utilizate pentru a evalua rata de eliminare a contaminanților și concentrațiile reziduale estimate. Se pot determina, de asemenea, coeficienții de partiție, cu condiția ca concentrațiile de echilibru să fie măsurate concomitent în fiecare fază, împreună cu focarul.



### 3.3 Analiza fezabilității SVE

- Contaminanții cu constante scăzute ale legii lui Henry sunt dificil de tratat prin SVE. În anumite condiții, se pot lua în considerare îmbunătățiri termice ale SVE pentru a îmbunătăți volatilitatea prin aer cald, injecție de abur sau alte tehnologii de încălzire subterană.
- SVE nu este eficientă în zona saturată, iar sondele de extracție trebuie poziționate astfel încât să țină cont de variațiile sezoniere ale nivelului freatic. În unele situri, se poate lua în considerare coborârea nivelului freatic prin pompare pentru a expune mai multe medii la tratare prin SVE.
- Cadrul geologic și gradul de eterogenitate laterală și verticală trebuie să fie luate în considerare la proiectarea sistemului pentru a se asigura că vaporii sunt eliminați în mod eficient din toate porțiunile intervalului țintă. De exemplu, este mai ușor să se inducă curgerea printr-un interval nisipos în comparație cu o lentilă de nămol sau argilă. De asemenea, un strat de argilă ar putea împiedica extragerea vaporilor în porțiuni din intervalul contaminat dacă un sondă nu este filtrat într-un mod care să țină cont de acesta.
- Solul cu un procent ridicat de finețe și un grad ridicat de saturație a apei va necesita aspirații mai mari, ceea ce va crește costurile și/sau va împiedica eficiența și uniformitatea tratamentului.
- Solul cu permeabilitate sau stratificare foarte variabilă poate duce la o extracție neuniformă a fluxului de gaz din zonele contaminate. După ce un sistem SVE este oprit (temporar sau permanent, poate avea loc o revenire a contaminanților din zonele cu permeabilitate mai mică, unde procesele de transfer de masă au fost mai puțin eficiente în timp. Pentru a ține cont de variațiile de permeabilitate/stratificare și de potențialul de revenire ar putea fi luate în considerare următoarele aspecte: proiectarea/plasarea sondelor de extracție și/sau operațiunile SVE (de exemplu, ciclarea sondelor de extracție, funcționarea pulsatorie), precum și eventuala necesitate de fracturare.
- Proiectarea sistemului SVE ar trebui să permită măsurarea debitului de aer și a concentrațiilor de contaminanți pentru fiecare sondă de extracție în parte (în loc de măsurători compozite la suflantă). Excluderea măsurătorilor pentru fiecare sondă în parte nu va permite o evaluare sau o optimizare adecvată a performanței. În cazul litologiei eterogene, nu este neobișnuit ca unul sau câteva dintre sondele de extracție dintr-o locație mai permeabilă să reprezinte aproape tot fluxul total de aer. Pe măsură ce ratele de îndepărtare a contaminanților scad în timp, opțiunea de a impulsiona sau de a închide sonde de extracție individuale cu rate mai mici de îndepărtare a contaminanților devine avantajoasă.
- Se recomandă instalarea de puncte de măsurare a vidului pentru un număr reprezentativ de locații în întreaga zonă de tratare, precum și distanțe față de sondele de extracție și adâncimi în cadrul diferitelor unități de sol pentru zonele de tratare mai adânci. Măsurătorile de vid la un număr suficient de sonde de gaz permit o extrapolare de ansamblu a ratelor fluxului de aer și a modelelor de distribuție în întreaga zonă de tratare. De asemenea, se pot colecta măsurători ale respirației (de exemplu, oxigen) și ale concentrației de contaminanți pentru a evalua influența reîncărcării și progresul eliminării, precum și pentru a identifica potențiale "zone moarte" de tratament inefficient care ar putea necesita o optimizare suplimentară pentru a fi rezolvate.
- Infiltrarea apei provenite din precipitații și/sau de la creșterea pânzei freatice în sistemul SVE poate ridica mai multe probleme operaționale. Conductele de transfer trebuie să fie înclinate înapoi către sondele de extracție sau către punctele de colectare amplasate strategic pentru a preveni blocarea conductelor. Ridicarea prin aspirație a unor volume mai mari de apă subterană de mică adâncime sau

antrenarea infiltrațiilor de precipitații în sistem poate supraîncărca separatorul aer/apă și poate provoca o coroziune severă și griparea pieselor interne ale suflantei (care vor necesita înlocuire). În timpul perioadelor de precipitații abundente sau de apă subterană de mică adâncime, este posibil să fie necesară fie oprirea sistemului SVE, fie reducerea vacuumului/fluxului de aer pentru a preveni aceste probleme.

- Deseori este necesară tratarea gazelor reziduale, ceea ce va crește semnificativ costul operațiunilor SVE. De exemplu, este posibil ca lichidele reziduale să necesite tratare/eliminare, GAC uzat va trebui regenerat sau eliminat, iar oxidarea termică/catalitică poate necesita costuri semnificative de operare cu energie electrică/gaze. Planificarea pe termen lung a proiectului ar trebui să permită o flexibilitate suficientă pentru a schimba sau a întrerupe tratamentul aerului pe măsură ce concentrațiile de contaminanți în fluxul de intrare scad în timp (de exemplu, utilizarea de echipamente închiriate, monitorizarea frecventă a fluxului de intrare în comparație cu cerințele de autorizare pentru tratare).
- Eficiența SVE tinde să scadă în timp, ajungând în cele din urmă la condiții asimptotice/plafon. Condițiile asimptotice/de platou pot fi un artefact al îndepărtării masei de contaminanți în principal din zonele cu permeabilitate mai mare, în timp ce există dificultăți în ceea ce privește îndepărtarea masei de contaminanți din zonele cu permeabilitate mai mică, din zonele cu umiditate mai mare sau cu o adsorbție mai mare a contaminanților în matricea solului. Se recomandă o evaluare suplimentară a proiectării și a operațiunilor sistemului SVE în cazul în care acest lucru se întâmplă într-un anumit sit. Analiza impactului pe care concentrațiile persistente de contaminanți îl pot avea asupra concentrațiilor din apele subterane sau asupra intruziunii de vapori ar trebui să se facă cu ajutorul unor instrumente de modelare adecvate. Ar trebui efectuate teste de revenire și măsurători ale concentrației de vapori la punctele de măsurare a vidului pentru a evalua nivelurile de contaminanți reziduali în întreaga zonă de tratare, pentru a lua decizii solide cu privire la necesitatea de a optimiza în continuare sistemul sau de a-l închide.
- Eficiența SVE poate fi îmbunătățită prin utilizarea unor programe de funcționare pulsatorie. Atunci când sistemul este oprit, contaminanții pot să se difuzeze în spațiul poros și apoi să fie măturați atunci când sistemul este activ.
- Temperatura gazelor reziduale poate limita opțiunile de tratare. Trebuie să se acorde o atenție deosebită includerii schimbătoarelor de căldură pentru a reduce temperatura înainte de tratare.

## 4 TESTELE DIN TEREN

Pentru aplicațiile SVE, este esențial să se caracterizeze în mod adecvat subsolul din perspectiva fluxului de aer. Deși predicția distribuțiilor reale de aer nu este practicabilă în acest moment, caracteristicile brute ale distribuțiilor de aer pot fi anticipate pentru geologii simple (de exemplu, medii foarte permeabile și omogene și medii cu eterogenități mari la scară mare, cum ar fi straturile de argilă în soluri altfel nisipoase) și, prin urmare, cunoștințele dobândite prin examinarea vizuală a carotelor de sol sunt adesea neprețuite pentru aplicațiile SVE.

La finalul fazei de caracterizare a sitului și înainte de fazele de screening și de testare pilot, datele de caracterizare a sitului ar trebui utilizate pentru a defini o zonă de tratament țintă și pentru a propune un model conceptual pentru distribuția aerului în sit.

Testul pilot SVE ar trebui să furnizeze date fiabile pentru proiectarea finală a sistemului în ceea ce privește:

- definirea zonei țintă de tratare;
- propunerea unui model conceptual pentru distribuția aerului în zona de tratare;
- ratele durabile ale fluxului de aer;
- rata totală de extracție a gazelor;
- ratele anticipate de eliminare a vaporilor de contaminanți;
- orientarea preferată a fluxului de aer subteran;
- raza efectivă de influență și să se determine dacă distanța dintre sonde este restrictivă din punct de vedere al costurilor și, în caz afirmativ, să se determine distanța minimă dintre sondele de injecție care nu este prohibitivă din punct de vedere al costurilor;
- să propună adâncimea, amplasarea și particularitățile de construcție ale sondelor;
- numărul de sonde de extracție a vaporilor necesare;
- tehnologia de tratare a vaporilor pentru gazele reziduale ale sistemului.



Figura 4.1- Raza de influență după Testul pilot (Confalonieri et al., see Annex1)

Principalii factori determinanți pentru acești parametri de proiectare SVE sunt: (1) natura și amploarea contaminării în sol, (2) distribuția permeabilității (adică eterogenitatea) solului și (3) concentrațiile de contaminanți în gazele extrase din sol. Se așteaptă ca aceste informații să fie disponibile dintr-un model conceptual al sitului în evoluție.

Pe lângă furnizarea de date pentru proiectarea sistemului la scară completă, un test pilot efectuat în mod corespunzător ar trebui să ajute consultantul să determine dacă pot fi respectate constrângerile temporale existente pentru închiderea proiectului, având în vedere ratele de eliminare a vaporilor care pot fi obținute.

ACTIVITATE	RĂSPUNSURI LA ÎNTREBĂRI
Testul de presiune/debit de injecție	Este posibil să se obțină debitul dorit la presiuni rezonabile?
Testul trasorului cu heliu	Care este aproximarea întinderii laterale a distribuției de aer? Există indicații privind direcțiile preferate?
Prelevarea gazelor din sol și a celor reziduale	Care este rata de volatilizare? Există pericole evidente pentru siguranță?
Măsurarea oxigenului dizolvat OD	Care este aproximația întinderii laterale a distribuției de aer? Există indicații privind direcțiile preferate?

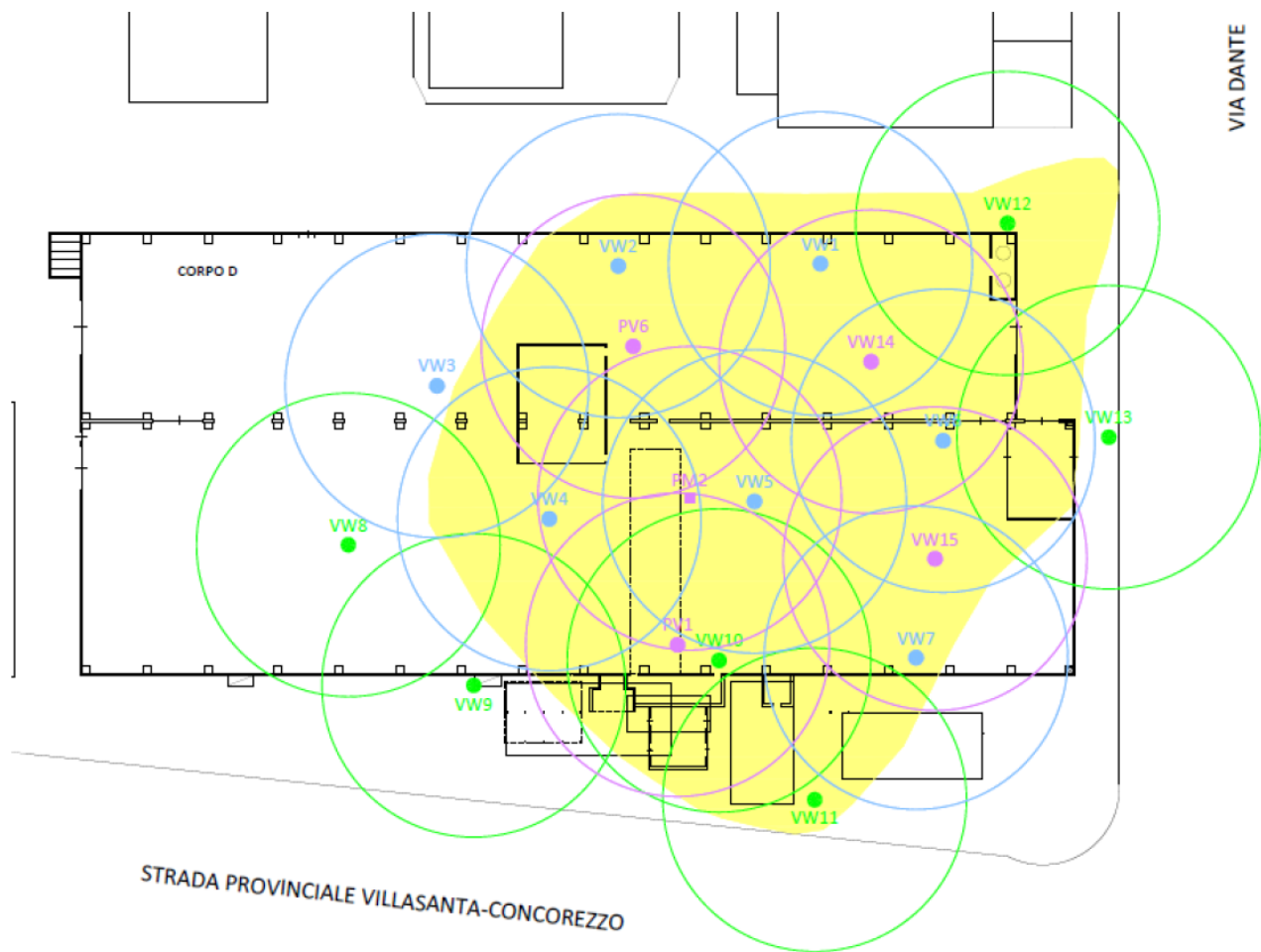
## 4.1 Testul pilot convențional

Datele convenționale de caracterizare a sitului sunt importante pentru evaluarea SVE, însă, aceste date sunt relativ statice și nu oferă informații suficiente pentru proiectarea la scară reală. În special, comportamentul dinamic al ratei de extracție a masei de contaminanți este dificil de prezis fără a efectua un test pilot de SVE. Comportamentul de extracție este guvernat în mare măsură de volumul de sol contaminat, de fracțiunile din volumul de sol caracterizate ca fiind advective față de cele difuzive, de caracteristicile de transfer de masă ale zonelor sursă limitate de difuzie, de amplasarea ecranelor de extracție în raport cu sursele și de existența unui NAPL. Discuția care urmează nu ia în considerare un NAPL, deși o zonă de concentrație persistentă care revine la o concentrație de echilibru aproape identică după mai multe perioade de extracție este un indicator al existenței unui NAPL.

Cu cât testarea pilot are loc mai devreme în procesul de planificare a remedierii (de preferință ca o componentă a caracterizării sitului), cu atât este mai puțin probabil să fie necesare modificări de proiectare după pornirea sistemului. Testarea pilot este recomandată în special în cazul siturilor mai mari și mai complexe.

Proiectarea testului pilot necesită specificarea unei rate totale de extracție a gazelor sau a duratei de extracție dorite. În mod ideal, testul pilot va extrage echivalentul a unul sau mai multe volume complete de pori de gaz din solul contaminat. Scopul acestui test este de a opera sistemul suficient de mult timp pentru a observa scăderea inițială a concentrației de COV extrași și reducerea concentrației în sondele de gaz din sol la diferite distanțe. Acest lucru va oferi o primă estimare a constrângerilor legate de transferul de masă și a razei de remediere eficientă de la o singură sondă [DiGiulio și Varahan, 2001a]. Ca regulă generală, rata și durata testului pilot se pot baza pe volumul total ( $V$ ) de sol contaminat din modelul conceptual al sitului, pe porozitatea solului și pe conținutul de umiditate al solului, după cum urmează:

$$Q = V_{sol} (1-S)$$

În figura de mai jos sunt prezentate concentrațiile de vapori de TCE în timpul a 3 zile de extracție la 64 Nm<sup>3</sup>/oră într-un sondă amplasată într-o zonă suspectă ca având conținut de vapori de TCE. Concentrația extrasă a scăzut rapid în timpul primelor ore de extracție, în conformitate cu rata estimată de extracție și schimb de gaze din sol. Concentrația de TCE a urmat apoi o descreștere mult mai lentă în timpul extracției ulterioare, care este asociată cu constrângerile de transfer de masă difuziv într-o unitate de argilă din mijlocul zonei vadoase. Aceste observații indică faptul că sistemul pilot a fost adecvat pentru a servi drept sistem la scară largă în acest sit de mici dimensiuni. S-a demonstrat, de asemenea, că utilizarea cărbunelui activ pentru tratarea vaporilor din gazele reziduale este rentabilă.



Figura 4.2- Exemplu de date privind concentrația de vapori de la un test pilot SVE

În cazul unei permeabilități mai scăzute a solului, este posibil să fi fost nevoie de o a doua sondă pentru a obține debitul dorit sau să fi fost necesară o perioadă de spălare mai lungă pentru a identifica constrângerile legate de transferul de masă. După cum se descrie mai jos, s-au obținut informații suplimentare privind constrângerile de transfer de masă prin măsurarea revenirii concentrației de vapori de TCE la sondă după încetarea extracției. În plus, în cazul în care concentrația de vapori de TCE ar fi fost inițial mai mare și ar fi persistat la o valoare substanțial mai mare după scăderea inițială, sugerând existența unui DNAPL, este posibil ca adsorbția cu carbon să nu fi fost rentabilă pentru rata mai mare de extracție a masei.

Punctele de monitorizare pot fi, de asemenea, instalate la mai multe adâncimi, inclusiv sub nivelul subsolului, dacă este cazul, și în intervalul de rază de influență (de exemplu, 3-15 m) al unui sondă de extracție pilot, dacă nu sunt deja disponibile în urma activităților anterioare de caracterizare a sitului. Fiecare locație de monitorizare ar putea avea mai multe puncte imbricate pe toată întinderea verticală a zonei vadoase, în funcție de adâncimea până la apele subterane și de stratificarea geologică.

După cum este ilustrat în figura de mai jos, punctele pot fi plasate deasupra, sub și în interiorul surselor suspecte. În timpul testelor pilot, aceste locații sunt utilizate pentru a măsura atât concentrația de vapori, cât și răspunsurile la vid.

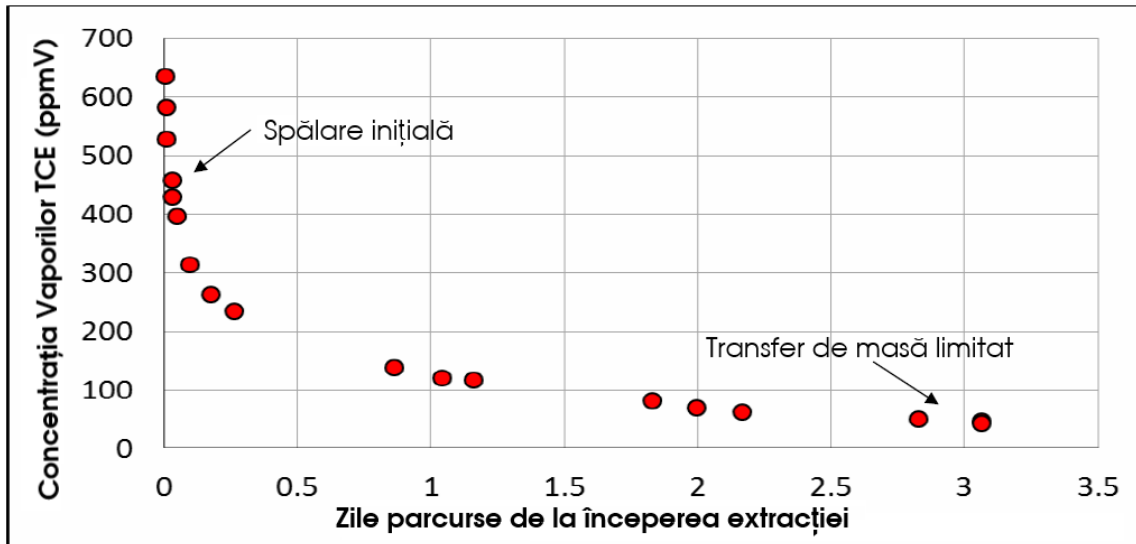

Figura 4.3- Scenarii conceptualizate pentru transferul de masă cu difuzie limitată și puncte tipice de monitorizare a gazelor din sol

Utilitatea datelor privind vidul depinde în mare măsură de permeabilitatea solurilor, iar datele nu pot fi folosite pentru a evalua raza de influență pentru SVE. Mai important este răspunsul concentrației de vapori. În cazul nisipurilor permeabile, un răspuns foarte mic la vid poate fi asociat cu un flux relativ mare de aer, în timp ce un răspuns semnificativ la vid într-o argilă nu oferă nicio dovadă că un flux apreciabil este asociat cu vidul. Cu toate acestea, datele de monitorizare a vidului pot fi utilizate pentru a evalua amploarea laterală versus verticală a fluxului și impactul condițiilor de suprafață (de exemplu, o scurgere cu permeabilitate scăzută pe o placă sau o suprafață de sol deschisă la atmosferă) asupra evacuării volumelor de sol de la suprafață.

În timpul testelor pilot, se recomandă un program robust de monitorizare a concentrației de vapori de COV pentru a identifica tendințele în punctele de monitorizare a gazelor din sol. Aceste tendințe pot fi corelate cu volumul de pori al solului măsurat în timpul testului pilot pentru a oferi o bază pentru spațierea sondelor de extracție în proiectarea la scară reală, pe baza frecvenței de spălare dorite (adică rata de schimb a volumului de pori), așa cum se discută în secțiunea următoare. Este încurajată utilizarea unui cromatograf de gaze pe teren de către un operator experimentat pentru a crește în mod rentabil dimensiunea setului de date privind COV din gazele din sol.

Adesea, evacuarea directă a gazelor reziduale fără tratare este inacceptabilă din cauza problemelor de sănătate, siguranță sau de interes public. În cazul în care condițiile indică faptul că acest lucru este necesar, pot fi puse în aplicare tehnologii de tratare a gazelor reziduale, cum ar fi cărbunele activ, oxidarea termică sau alte tehnologii relevante, pentru a îmbunătăți calitatea gazelor reziduale în vederea eliberării în atmosferă.

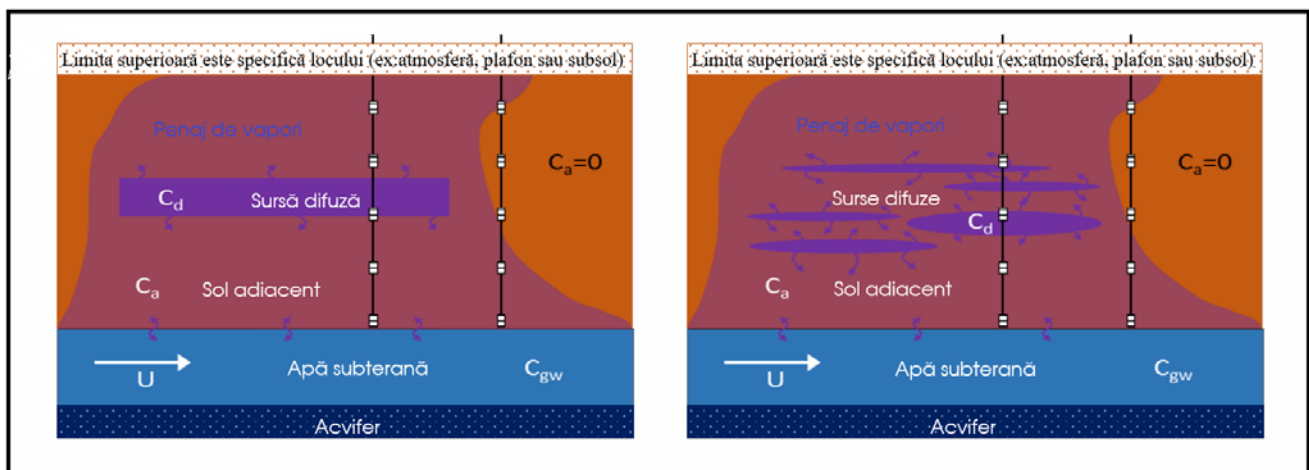
#### 4.1.1 Echipament convențional pentru testele pilot

Echipamentul pentru studiul pilot SVE poate consta din următorul echipament [Farallon 2019] sau echivalent:

- O suflantă regenerativă montată pe patină de cel puțin 1 CP (echivalentă cu un Rotron DR 404), capabilă să atingă 50 de inch de vid în coloana de apă și debite de până la 105 ft<sup>3</sup> pe minut.
- Un separator de umiditate cu indicator de vid, supapă de siguranță și supapă de golire.
- Un colector format dintr-o serie de supape, indicatori de vid și un debitmetru capabil să monitorizeze debitele de aer de extracție cuprinse între 0,66 și 100 de ft<sup>3</sup> pe minut și un vid cuprins între 0,1 și 80 de inch de coloană de apă.
- Racorduri flexibile cauciucate, furtunuri flexibile și/sau fittinguri de clorură de polivinil de tip Schedule 40 pentru a conecta echipamentul de la sonda de extracție SVE la un punct de evacuare a vaporilor.

Sondele de observație trebuie să aibă fittinguri etanșe la vid care să se termine cu o supapă cu bilă pentru conectarea la un vacuummetru pentru a monitoriza vidul observat pe parcursul activităților studiului pilot. În figura de mai jos este prezentată o diagramă a procesului și a instrumentelor.



Figura 4.4- Exemplu de diagramă de proces și de instrumentație (Farallon Consulting)

#### 4.1.2 Testul SVE de creștere a vidului în trepte

Testul pilot SVE trebuie efectuat ca un test în trepte, folosind cel puțin trei trepte de debit de aer. Durata fiecărei etape a testului trebuie să fie cel puțin egală cu durata necesară pentru ca parametrii mășurați la punctele de monitorizare a vidului să ajungă la starea de echilibru. În timp ce se mențin constante debitul și vidul aplicat la puțul de extracție a vaporilor (trebuie efectuate măsurători frecvente pentru a asigura această condiție), trebuie efectuate măsurători de presiune la puțul de extracție și la toate punctele de monitorizare a vidului din sol. Monitorizarea ar trebui să fie frecventă la începutul testului pilot (la fiecare cinci până la zece minute); intervalul de timp dintre măsurătorile de vid poate crește pe parcursul testului.

Pentru testul pilot se recomandă cel puțin un sondă de extracție a vaporilor din sol și trei puncte de monitorizare a vidului, amplasate la diferite distanțe de sonda de extracție. Se recomandă sonde de extracție a vaporilor din sol și puncte de monitorizare dedicate; cu toate acestea, se pot accepta sonde de monitorizare a apelor subterane dacă amplasarea și construcția acestora sunt adecvate pentru sit. Aprobarea utilizării sondelor de monitorizare a apelor subterane pentru sondele de extracție SVE sau a punctelor de monitorizare se va face în funcție de fiecare sit în parte. Ca regulă generală, punctele de monitorizare a vidului ar trebui să fie amplasate la cinci până la zece ft, zece până la douăzeci de ft, douăzeci până la patruzeci de ft și la mai mult de patruzeci de ft de puțul de extracție a vaporilor. Punctele de monitorizare a vidului ar trebui să fie instalate radial față de sonda de extracție a vaporilor (adică la o distanță de 120° unul față de celălalt), mai degrabă decât în linie, pentru a evalua mai bine potențialele căi preferențiale ale fluxului de aer de pe amplasament. În cazul în care contaminarea solului se extinde prin mai multe unități cu permeabilitate variabilă, fiecare unitate stratigrafică separată trebuie evaluată cu propriul sondă de extracție a vaporilor din sol și cu trei puncte de monitorizare a vaporilor.

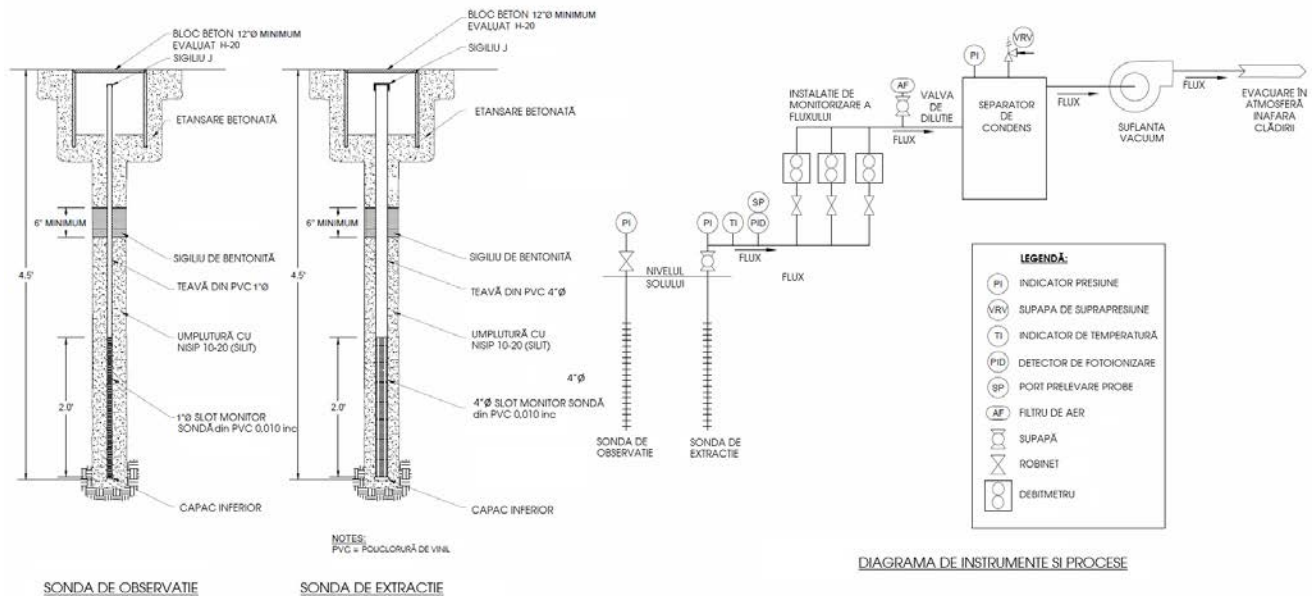



Figura 4.5- Poziționare tipică la 120° a punctului de monitorizare SVE (Confalonieri et al., vezi Anexa 1)

Un sondă tipică de extracție a aerului este o sondă verticală cu diametrul de 1 până la 4 inch, cu un interval de filtrare de 1 până la 5 ft, dar aceste date ar trebui să fie analizate în funcție de fiecare sit în parte.

Înainte de a pune în aplicare testul în trepte SVE, se vor colecta citirile de bază ale vidului din sondele de observație. Se recomandă, de asemenea, un screening pe teren pentru vapori organici, care ar trebui efectuat cu un detector cu ionizare de flacără (FID) sau o combinație între un detector de fotoionizare (PID) și un explozimetru.

Testul în trepte SVE se efectuează prin creșterea incrementală a vidului aplicat la puțul de extracție SVE. Cantitatea maximă de vid care poate fi aplicată la puțul de extracție SVE se bazează pe distanța de la partea superioară a ecranului expus al puțului până la partea superioară a pânzei freatice sau pe echipamentul disponibil. Pe baza curbei suflantei pentru o suflantă regenerativă de 1 cal putere, vidul maxim anticipat aplicat la puțul de extracție SVE va fi de 50 de inch de coloană de apă [Farallon 2019]. Treptele incrementale vor fi aplicate la 30, 70 și 100 % din valoarea maximă a vidului nominal al suflantei. În timpul fiecărei etape a testului în trepte, următorii parametri trebuie monitorizați la intervale de 15 minute, cel puțin până la stabilizarea criteriilor (mai puțin de 5 % diferență între evenimente) sau pentru o durată maximă de 2 până la 3 ore la fiecare etapă de vid:

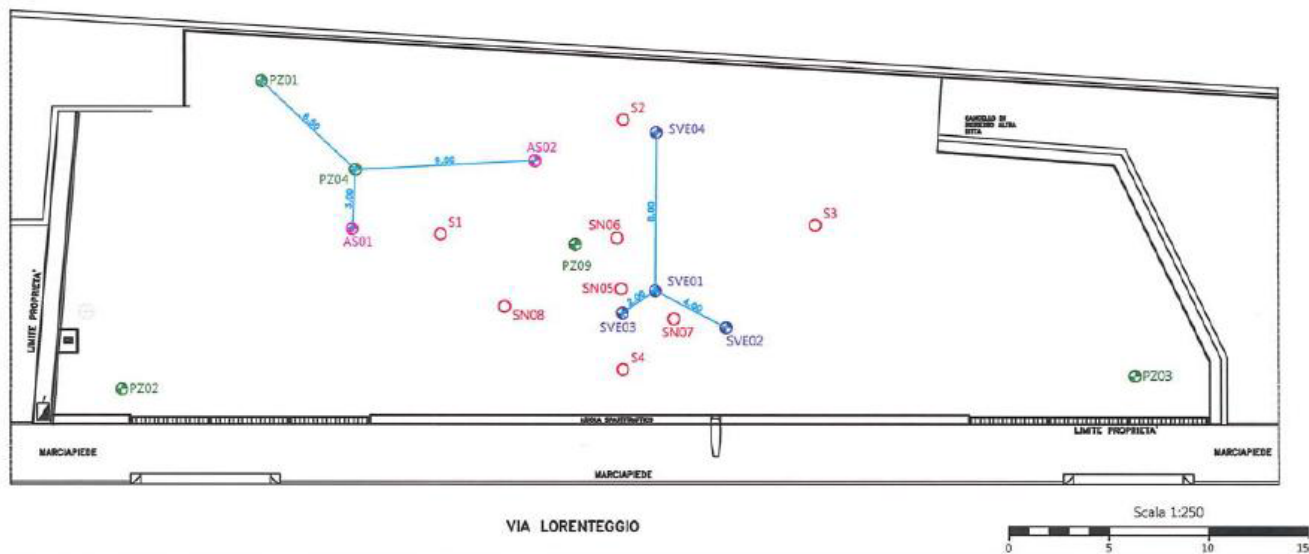
- Vacuum aplicat la puțul de extracție SVE;
- Debitul de extracție din puțul de extracție SVE;
- Temperatura vaporilor extrași;
- Măsurători ale compușilor organici volatili din fluxul de vapori extrași cu un detector de fotoionizare;
- Vacuum la sondele de observare;
- Citirile de vid se înregistrează ca citiri ale presiunii manometrice.

minutes	Pid ppm	Lel %	O2 %	CO2 %	Depress mbar	V m/s	T °C	Q mc/h
<b>0</b>	480.1	18	21.3	1.22	-286.0	7.74	1.4	47
<b>10</b>	2147.0	16	21.5	3.45	-258.0	6.57	0.8	47
<b>30</b>	2371.0	13	20.9	3.16	-249.0	6.23	4	43
<b>60</b>	4106.0	13	20.9	2.7	-236.0	6.77	4.1	50
<b>90</b>	4469.0	10	20.9	2.26	-232.0	7.46	4.6	53
<b>120</b>	5000.0	10	20.9	2.08	-229.0	8.27	5.2	57
<b>180</b>	5000.0	9	20.9	1.83	-225.0	9.03	5.9	64
<b>240</b>	5000.0	9	20.9	1.62	-222.0	9.53	6.9	67
<b>300</b>	5000.0	8	20.9	1.44	-220.0	9.6	7	72

Figura 4.6- Exemplu de tabel de monitorizare (Confalonieri et al., vezi Anexa 1)

Eșantioanele de vapori pot fi colectate în cutii Summa și/sau saci de Tedlar și/sau suporturi similare și echivalente și trimise pentru analize de laborator la sfârșitul fiecărui test în etape, la concentrația maximă a vaporilor de extracție măsurată cu detectorul de fotoionizare.

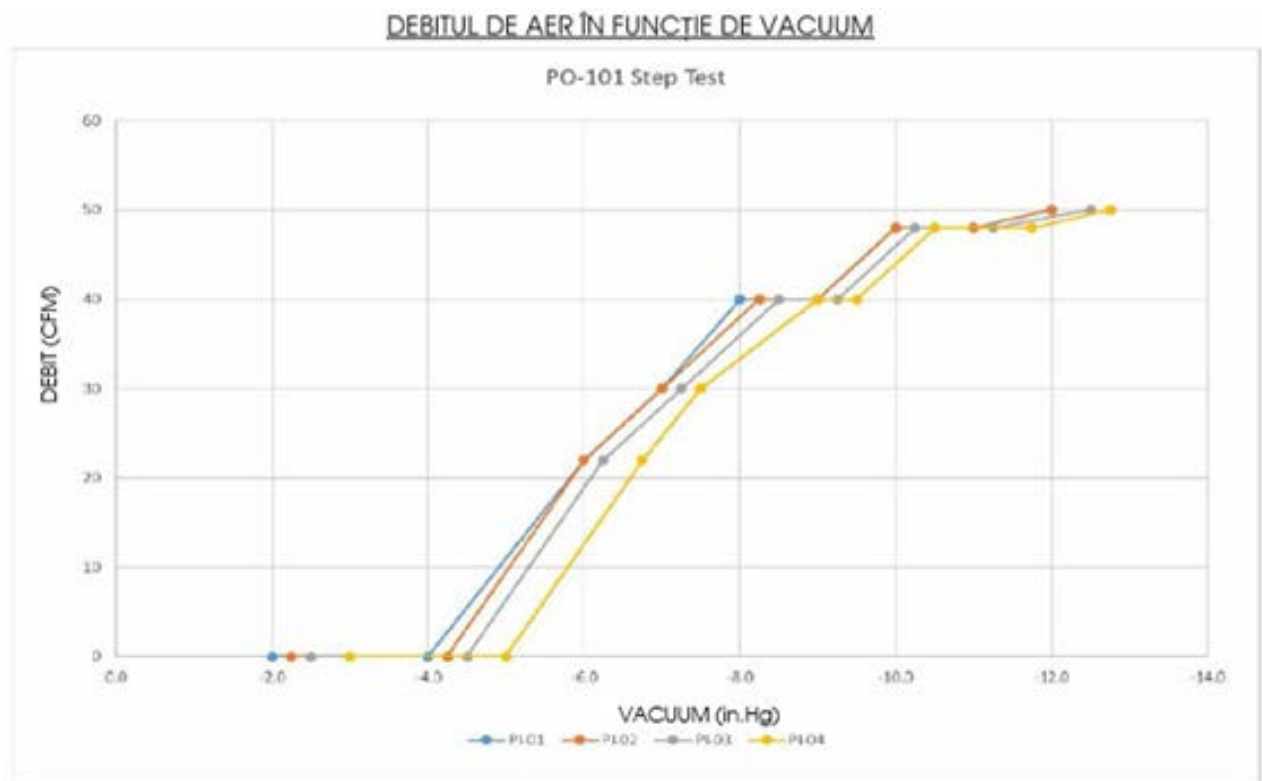

Figure 4.7- Exemplu de test de creștere a vidului în trepte SVE (Menozzi et al., vezi Anexa 1)

#### 4.1.3 Testul SVE de vid constant

Pe baza rezultatelor testului în trepte SVE, s-a putut determina vidul ideal și debitul de extracție pentru a finaliza testul de vid constant SVE, care este cea de-a doua componentă a studiului pilot SVE. Vidul și debitul

optim ar trebui să fie determinate pe baza vidului și a debitelor observate la puțul de extracție, a recuperării vaporilor, a răspunsului observat la sondele de observație și a influenței asupra nivelului apelor subterane. Debitul optim ar putea fi determinat, de asemenea, din raza de influență determinată în cadrul testului în trepte.

Testul de vid constant SVE ar trebui să aibă loc imediat după testul în trepte SVE și să funcționeze timp de aproximativ 24 de ore. Parametrii de testare monitorizați pentru testul în trepte vor fi, de asemenea, monitorizați și înregistrați la intervale de 15 minute în timpul testului de vid constant SVE:

- Vacuum aplicat la puțul de extracție SVE;
- Debitul de extracție din puțul de extracție SVE;
- Temperatura vaporilor extrași;
- Măsurători ale compușilor organici volatili din fluxul de vapori extrași cu un detector de fotoionizare;
- Vacuum la sondele de observare;
- Citirile de vid se înregistrează ca citiri ale presiunii manometrice.

Intervalul de timp de monitorizare poate fi modificat în timpul testului pilot pe baza observațiilor de pe teren. Testul de vid constant al SVE cu durată mai lungă ar ajuta la evaluarea concentrațiilor de emisii în regim staționar și a fluxului de aer și a vidului operațional al SVE specifice locului.

Eșantioanele de vapori ar putea fi colectate în canistre Summa și/sau în saci de Tedlar și/sau pe un suport similar și echivalent și trimise pentru analize de laborator la sfârșitul testului de vid constant SVE.

## 4.2 Testul de distribuție și recuperare a heliului

În timp ce un test cu trasor cu heliu nu este o practică obișnuită din cauza aprovizionării limitate, unul dintre punctele forte ale acestui test este că poate fi repetat cu ușurință, de obicei cu întârzieri de doar câteva ore între ele. Acest lucru permite evaluarea rapidă a efectelor modificărilor de proces (de exemplu, distribuția fluxului de aer din diferite sonde).

Heliul este cel mai des utilizat gaz de urmărire, deoarece este relativ ieftin, ușor de găsit, iar instrumentele analitice sunt disponibile pentru utilizare pe teren. Detectoarele obișnuite pot detecta concentrații de heliu de la 0,1% la 100%. Acesta este calibrat din fabrică, astfel încât nu poate fi calibrat pe teren, dar ar trebui să se facă verificări cu etaloane de heliu pentru a verifica dacă instrumentul funcționează corect. În mod obișnuit, probele de vapori trebuie colectate în saci sau canistre Tedlar. Detectorul de heliu este apoi atașat direct la recipientul de probă pentru măsurare. Alternativ, detectorul de heliu poate fi modificat pentru a preleva probe în mod continuu. Eșantionarea continuă este foarte convenabilă atunci când se măsoară gazele SVE în cazul în care este disponibil un flux continuu.

Testele de recuperare a trasorului descrise aici pot fi efectuate ca parte a unui test pilot sau în timpul funcționării la scară largă. Testul este foarte simplu de efectuat și de interpretat. Practic, se introduce un trasor inert (de obicei heliu) în sol la o rată constantă și cunoscută, iar concentrația de trasor este monitorizată în aerul din gazele SVE. După o anumită perioadă de timp (de exemplu, o oră sau mai puțin pentru multe sisteme), concentrația de trasor în gazul de evacuare începe să crească. Aceasta continuă să crească și, în cele din urmă, ajunge la un platou stabil. Procentul de aer care este captat poate fi calculat prin înmulțirea debitului SVE cu fracția de heliu din aerul SVE după ce concentrația s-a stabilizat și împărțirea acestui număr la rata de injecție a trasorului, după cum se arată mai jos.

$$\% \text{ Recuperare} = \frac{\text{debit extracție SVE}}{\text{Rata de injecție a urmelor}} \times \% \text{ trasorul cu gazul oprit} \times 100 \%$$

$\% \text{ Recuperare} = \text{Debitul de extracție SVE} \% \times \text{trasor cu gazul oprit} \times 100 \%$

O tehnică de teren mai robustă pentru calcularea recuperării este de a măsura mai întâi "concentrația de recuperare de 100%" în gazul de evacuare SVE prin injectarea directă a heliului în colectorul SVE. (Trebuie avut grijă să se asigure că debitul este același în ambele cazuri, deoarece contrapresiunile pentru cele două sisteme sunt semnificativ diferite). În acest caz, procentul de recuperare este pur și simplu concentrația de heliu măsurată în gazul de evacuare SVE împărțită la "concentrația de recuperare 100%".

În cazul în care se utilizează heliu ca trasor, concentrația de injecție trebuie menținută sub 10% în volum pentru a evita efectele de flotabilitate în zona vâscoasă. Pentru a asigura un debit constant de heliu în condiții de contrapresiune variabilă, trebuie utilizat un debitmetru calibrat cu citire directă, împreună cu un manometru și o supapă de dozare pentru a asigura o contrapresiune constantă și ridicată la debitmetru.

Testul de recuperare a trasorului este conceput ca un "semnal de alarmă" pentru performanța sistemului. În cazul în care recuperarea heliului este scăzută, este posibil ca aerul (și heliul) să fie blocat sub pânza freatică, sub straturile cu permeabilitate mai mică și să se deplaseze lateral, dincolo de raza de acțiune a sistemului SVE.

În unele cazuri, este posibil ca heliul să nu se întoarcă în sondă din cauza prezenței unor straturi continue. Prezența acestor straturi ar trebui, de asemenea, să poată fi detectată prin monitorizarea presiunii apei subterane în timpul pornirii și opririi sistemului. Prin urmare, se recomandă ca testul de recuperare a heliului să fie efectuat împreună cu măsurătorile presiunii apei subterane.

Dacă recuperarea heliului este ridicată (de exemplu, >80%), atunci sistemul SVE funcționează bine și este puțin probabil ca migrarea laterală a vaporilor să constituie o problemă.

### 4.3 Monitorizarea gazului din sol



Figura 4.1- Exemplul unei instalatii Nesty (Trezzi et al., vezi Anexa 1)

În timpul testului pilot, ar trebui să se colecteze probe de gaze din sol din puțul de extracție a vaporilor de sol la fiecare pas de debit pentru o eventuală analiză de laborator. Frecvența și numărul de eșantioane trimise pentru analiza de laborator trebuie să se bazeze pe condițiile specifice ale sitului; cu toate acestea, cel puțin un eșantion colectat din etapa cu cea mai mare citire a instrumentului de teren, trebuie trimis pentru analiza de laborator. Prelevarea de probe de vapori trebuie efectuată la punctul de extracție a vaporilor de la un orificiu de prelevare a probelor situat între capul de sondă și suflantă. Se poate folosi un sac de Tedlar, un tub de cărbune sau o canistră de tip Summa pentru a colecta eșantioane de laborator pentru analizele de COV, CO<sub>2</sub> și O<sub>2</sub>, deși se preferă cea din urmă. Metoda analitică trebuie să fie aprobată de personalul tehnic al proiectului. Tuburile Draeger sunt utilizate în mod obișnuit pentru măsurarea CO<sub>2</sub> și pot fi, de asemenea, acceptabile pentru monitorizarea concentrației de COV. În cazul în care nu se pot obține cerințe minime specifice de raportare din cauza condițiilor specifice ale amplasamentului, acest lucru trebuie explicat sau discutat.

Creșterile concentrațiilor de contaminanți din gazele reziduale și rata de extracție SVE pot fi utilizate pentru a determina o rată de eliminare a masei. Desigur, măsurătorile efectuate pe durata scurtă a unui test pilot nu sunt un indicator al performanței pe termen lung. Cu toate acestea, se poate presupune, în general, că datele testului pilot reprezintă rata maximă de eliminare din sistem. În acest context, dacă ratele de îndepărtare a masei în timpul (de exemplu, la încheierea) testului pilot sunt prea scăzute, atunci ar trebui să existe o îngrijorare semnificativă cu privire la viabilitatea SVE în sit.

## 4.4 Echipamente minime pentru testarea SVE pe teren

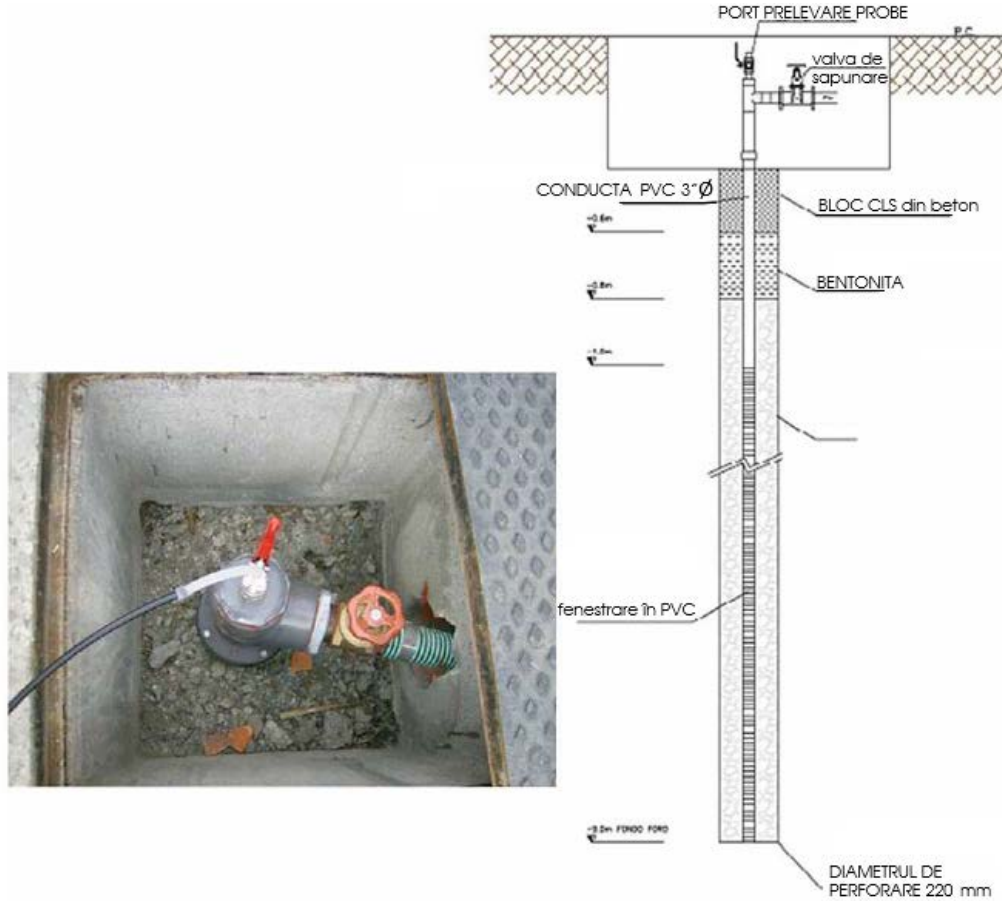
Un test pilot pentru un sistem de extracție a vaporilor din sol include un sondă de extracție situat în zona contaminată, un sondă de construcție similară situat într-o zonă în care nu există documente de contaminare și un număr de sonde de observație corespunzătoare. Alte părți importante ale configurației testului pilot pot include:

- o suflantă sau un aspirator portabil;
- orificii de prelevare a probelor din sondă;
- instrumente de măsurare pentru sondele de extracție;
- echipament de colectare a probelor.

Instrumentele de măsurare comune includ:

- un contor de fotoionizare (PID), care măsoară cantitatea de compuși volatili care se eliberează;
- un număr de vacuumetre sau debitmetre de aer pentru a ajuta la determinarea razei de influență pentru fiecare sondă de extracție;
- termometre pentru a ajuta la determinarea temperaturii vaporilor din sol, care pot afecta rata generală a debitului de aer.

Echipamentul de prelevare a probelor poate include:

- saci Tedlar și pompe de aer portabile pentru colectarea probelor de influent sau efluent;
- dispozitive de vidanare de unică folosință pentru colectarea probelor de apă sau de produs din sondele de observație.

## 4.5 Sonda de extracție

Sondele de extracție sunt parte integrantă a unui test pilot al sistemului de remediere SVE. Aceste sonde reprezintă o modalitate de îndepărtare a contaminării din zona vâscoasă prin crearea unui gradient de presiune negativă. Contaminarea este "aspirată" spre puțul de extracție, deoarece există o presiune mai mică la puțul de extracție. Cheia în orice plan de remediere care utilizează extracția de vapori ca tehnică de îndepărtare este de a determina valoarea corectă a modificării gradientului de presiune care este necesară pentru a fi eficientă. Un test pilot este o modalitate obișnuită de a determina aceste informații.

Desigur, dacă se prelevează probe doar la sondele de extracție, imaginea obținută va fi una incompletă. În timp ce observațiile la sondele de extracție vor furniza informații despre modul în care se schimbă condițiile la locul de extracție, s-ar putea să nu se extindă mult dincolo de acestea, de aceea sondele de observație sunt atât de importante. Sondele de observație, care sunt filtrate în mod similar cu sondele de extracție corespunzătoare, vor furniza informații precum fluctuația apei subterane, gradientii de presiune a vaporilor și chiar schimbările în migrarea penajului contaminat. Prin prelevarea regulată de probe și măsurători, atât la sondele de observație, cât și la cele de extracție, un om de știință poate obține o imagine mai completă și mai specifică decât ar putea oferi oricare dintre aceste părți în mod individual. În mod ideal, măsurătorile efectuate ar trebui să includă nivelul apei subterane, măsurat cu un indicator de nivel al apei, grosimea oricărui produs în fază liberă, măsurată cu o sondă de interfață, și concentrația de COV, determinată cu ajutorul unui aparat de fotoionizare. Probele prelevate ar trebui să includă eșantioane de aer din echipamentul de intrare și de ieșire, precum și orice gaze reziduale asociate cu tratamentul propus pentru vaporii extrași. Aceste eșantioane colectate ar trebui să fie testate în laborator pentru analize precum compușii organici volatili (COV) și hidrocarburile

petroliere totale (TPH). Nevoile specifice de analiză vor varia de la un stat la altul, așa că este o idee bună să contactați autoritatea locală de reglementare pentru îndrumare, dacă este necesar.

#### 4.6 Propunere de testare pilot – Cerințe minime

1. Expunere de motive privind procedurile de teren, rezultatele testului pilot, inclusiv determinarea razei efective de influență, precum și o discuție privind compoziția contaminanților și ratele de eliminare a vaporilor.

2. Date statice (înainte de test):

- date statice privind nivelul apei (la cel mai apropiat 0,01 ft.) dacă sondele de monitorizare sunt utilizate ca puncte de monitorizare a vidului sau puncte de extracție a vaporilor;
- temperatura solului și a aerului;
- presiunea statică (inch H<sub>2</sub>O); și condițiile atmosferice (presiune și temperatură).

3. Datele de testare colectate la punctul de extracție (raportate pentru intervale de timp specificate):

- debitul de aer;
- înălțimi ale nivelului apei cu o aproximație de 0,01 ft (dacă se utilizează un sondă de monitorizare);
- concentrațiile de COV, CO<sub>2</sub> și O<sub>2</sub>;
- măsurători FID (sau PID și explozimetru);
- presiune;
- temperatura solului și a aerului.

4. Date de testare colectate la punctul de monitorizare a vidului (raportate pentru intervale de timp specificate):

- vid (inch H<sub>2</sub>O);
- înălțimea nivelului apei (cu o precizie de 0,01 ft).

5. Figuri

- hărți ale sitului (desenate la scară) care ilustrează amplasarea zonei (zonelor) sursă, punctele de extracție și de monitorizare a vidului, clădirile, zona pavată și șanțurile pentru utilități, gradul de contaminare a solului și a apelor subterane și nivelul freatic pentru ziua testului pilot;
- secțiuni transversale geologice ale sitului, ilustrând principalele caracteristici geologice, distribuția contaminanților și amplasarea punctelor de extracție și de monitorizare;
- diagrame de construcție a sondelor de extracție și a punctelor de monitorizare a vidului.
- schema de construcție care să ilustreze designul colectorului, inclusiv următoarele elemente: conducte, instrumente, supape, orificii de prelevare a probelor și orice alte componente ale sistemului de testare pilot.

6. Grafice:

- vidul normalizat (vidul punctului de monitorizare/vidul punctului de extracție) în funcție de distanța față de puțul de extracție pentru fiecare treaptă de debit (trasate pe hârtie semi-log);
- vidul aplicat (inch H<sub>2</sub>O) în funcție de debitul de aer la puțul de extracție pentru fiecare pas al debitului de aer;
- concentrația totală de vapori de COV în funcție de timp;
- elevația apei subterane în funcție de timp.

## 4.7 Alternativă la testarea pilot

Efectuarea unui test pilot pentru sistemul dumneavoastră de remediere este ideală, atât pentru remedierea pe termen lung, cât și din punct de vedere economic. În unele situații, aceste opțiuni nu sunt viabile și există alte opțiuni disponibile. Deși s-ar putea să nu fie la fel de eficiente din punct de vedere al costurilor ca efectuarea câtorva teste preliminare înainte de instalare, se știe că acestea oferă rezultate acceptabile.

Prima alternativă la efectuarea unui test pilot este de a instala pur și simplu un sistem de remediere temporară la fața locului și de a începe imediat procesul de remediere. Progresele tehnologice de astăzi au produs sisteme SVE mai mici și mai versatile, iar multe dintre acestea sunt oferite în regim de închiriere. Aceste sisteme mai mici și mobile permit efectuarea de modificări, dacă este necesar.

A doua alternativă la efectuarea unui test pilot este utilizarea informațiilor de referință generalizate despre sit pentru a estima caracteristicile acestuia. Dacă se cunosc litologia și extinderea de bază a contaminării, atunci se poate utiliza analiza dimensiunilor granulelor pentru a estima permeabilitatea solului și, în cele din urmă, fluxul de aer. Această metodă "pe dos" este bună pentru zonele cu cantități relativ mici de contaminare. Dezavantajele acestei metode constau în faptul că, uneori, parametrii fizici și chimici percepuți nu sunt aceiași la nivelul întregului sit și există o dificultate marcantă în evaluarea condițiilor geologice stratificate. În plus, în cazul în care sistemul de remediere implică emisii în aer, estimările concentrațiilor în aer nu ar fi disponibile înainte de implementare.



Figura 4.1- Schema cu o singură suflantă

Aceste etape pot fi sau nu efectuate într-o manieră secvențială.

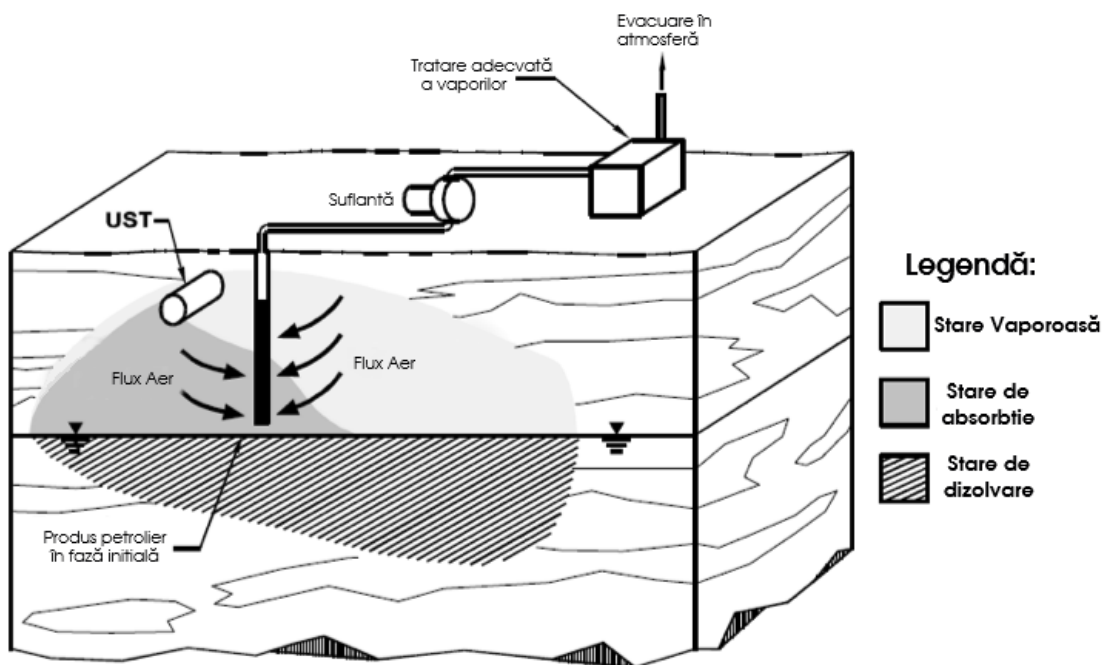

## 5 MONITORIZAREA PERFORMANȚEI

Monitorizarea se efectuează în timpul fazei operaționale pentru a evalua progresul remedierii și înainte de oprirea sistemului, pentru a verifica îndeplinirea criteriilor de curățare.

Planul de monitorizare ar trebui să includă prelevări de probe mai frecvente la pornirea sistemului și pentru confirmarea curățării. În timpul monitorizării din faza operațională, odată ce sistemul este optimizat, frecvența și intensitatea eșantionării pot fi reduse [USACE 2002].

### 5.1 Monitorizarea fazei operaționale

Mai jos este prezentată o scurtă descriere a principalilor parametri care trebuie luați în considerare în timpul monitorizării de rutină.

#### 5.1.1 Parametrii chimici

- Monitorizarea chimică a gazelor din sol este necesară pentru a evalua eficiența procesului de remediere. Gazele din sol trebuie colectate din sonde de extracție individuale și sonde de gaze din sol. În timpul fazei operaționale, instrumentele de teren, cum ar fi detectoarele cu flacără sau de fotoionizare, sunt adesea utilizate pentru măsurători frecvente sau continue ale cantității totale de COV. Măsurătorile efectuate cu instrumentele menționate mai sus ar trebui să fie considerate ca metode de screening, din cauza răspunsurilor lor nespecifice și a următoarelor alte limitări [EPA 2001]:
  - Potențialul ridicat de ionizare al multor COV comuni va duce la nedetectarea cu ajutorul unei lămpi PID convenționale.
  - Efectele matricei de gaz, cum ar fi umiditatea, dioxidul de carbon și alcanul (în special metanul) pot reduce răspunsul PID. Cu toate acestea, atunci când umiditatea relativă este foarte ridicată, aproape de 100%, vaporii de apă se pot condensa pe senzor, provocând un răspuns fals pozitiv. Acest semnal se datorează unei scurgeri de curent între electrozii din senzor [RAE System 2013].
  - Conținutul ridicat de halogen al multor COV comuni va duce la subestimarea sau nedetectarea COV cu ajutorul unui FID.
- Măsurătorile COV și ale debitului în influentul sistemului SVE și, eventual, în sondele de extracție individuale, ar trebui utilizate pentru a calcula ratele de eliminare a masei de contaminanți din solul nesaturat.
- Concentrațiile de contaminanți se măsoară de obicei la influentul și efluentul sistemului de tratare a gazelor reziduale (înainte și după canistrelor de carbon) pentru a evalua eficiența sistemului de control al emisiilor în aer.
- Monitorizarea chimică a apelor subterane: remedierea în zona vâscoasă nu ar trebui să fie efectuată independent de condițiile apelor subterane. Solul nesaturat poate fi, de fapt, recontaminat prin acțiunea capilară și fluctuațiile nivelului freatic. Concentrațiile de contaminanți din apa subterană ar trebui, de asemenea, monitorizate pentru a evalua transferul de masă din faza apoasă în gazul din sol.

#### 5.1.2 Parametrii fizici

- Măsurarea temperaturii solului și a vaporilor: Datele privind temperatura vaporilor pot ajuta la evaluarea eficienței sistemului de control al vaporilor și permit normalizarea datelor privind debitele, după cum se arată mai jos. Temperaturile solului ar putea fi un indicator al proceselor de biodegradare care au loc în zona vâscoasă.

- Umiditatea relativă: conținutul de umiditate reduce volumul spațiului poros care contribuie la curgerea fluidelor. Prin urmare, un nivel ridicat de umiditate poate reduce permeabilitatea aerului și fluxul de aer prin zona vâscoasă; din același motiv, poate influența rezultatele monitorizării gazelor din sol. În plus, umiditatea relativă a gazului extras poate fi redusă pentru a proteja suflanta și pentru a promova eficiența sistemului de control al emisiilor de vapori (capacitatea de adsorbție a cărbunelui activ este redusă semnificativ atunci când umiditatea relativă este mai mare de 50%). De obicei, umiditatea relativă a fluxului de vapori poate fi redusă cu ajutorul unui sistem de încălzire a aerului [USACE 2002]. Adesea, suflanta instalată furnizează căldura necesară. Încălzirea fluxului de vapori este limitată de cea mai mare temperatură admisă în timpul utilizării cărbunelui activ.
- Nivelurile apei: ar trebui monitorizate în zona sondelor de extracție pentru a determina cantitatea de afluență care apare ca urmare a vidului aplicat. Este necesar să se acorde o atenție deosebită fluctuației nivelului freatic, deoarece aceasta ar putea spori transferul de masă al contaminanților între faza solidă, lichidă și gazoasă. În plus, creșterea cantității de apă poate provoca un exces de umiditate în zona de tratare, reducând capacitatea de absorbție a cărbunilor activi. Această problemă poate fi atenuată prin îmbunătățirea separării umidității și/sau prin pomparea activă a apei subterane pentru a contracara creșterea de apă in situ [USACE 2002].
- Măsurarea debitului: datele privind debitul din fiecare puț, împreună cu vidul aplicat corespunzător, pot furniza informații despre permeabilitatea la aer a zonei vadoase. Se recomandă normalizarea debitelor la o temperatură și o presiune standard, astfel încât datele colectate în cadrul diferitelor studii să poată fi comparate cu ușurință.
- Măsurarea vidului/presiunii: măsurarea vidurilor observate în diferite locații și la diferite adâncimi oferă o indicație privind căile de curgere a aerului. Gradienții de presiune determinați din măsurătorile de vid trebuie cuplați cu estimări ale conductivității orizontale și verticale a aerului pentru a evalua timpii de deplasare sau viteza [Truex 2013].

### 5.1.3 Meteorologie

Datele meteorologice (de exemplu, precipitațiile, presiunea barometrică, temperatura ambiantă) trebuie înregistrate și luate în considerare pentru o evaluare corectă a rezultatelor monitorizării.

- Precipitații: fenomenele de precipitații, care limitează transportul contaminanților volatili în solul nesaturat, pot avea un efect semnificativ asupra performanței SVE/BV și asupra rezultatelor monitorizării gazelor din sol. Prin urmare, prelevarea de probe de gaze din sol nu ar trebui să aibă loc după un eveniment de ploaie semnificativ (1/2 inch sau mai mult de precipitații pe o perioadă de 24 de ore). Calculul perioadei de așteptare ar trebui să se bazeze pe curbele de drenaj ale solului [CalEPA 2015].
- Presiunea barometrică: Fluctuațiile presiunii atmosferice induc mișcarea gazelor între atmosferă și subsol. Mișcarea gazelor în zona nesaturată indusă de fluctuațiile naturale ale presiunii atmosferice este denumită pompă barometrică. Atunci când presiunea atmosferică scade, gazele sunt atrase în sus din subsol în atmosferă. În schimb, atunci când presiunea atmosferică crește, aerul proaspăt este împins în jos în subsol [Kuang 2013]. Efectul fluctuațiilor presiunii barometrice asupra transportului gazelor atmosferice poate fi mai evident în timpul perioadelor de oprire.

## 5.2 Confirmarea curățării și închiderii sistemului

Obiectivul procesului de remediere este, în general, atingerea unor standarde de calitate prestabilite pentru diferite matrici de mediu. Criteriul final de închidere a unui sistem SVE se bazează, de obicei, pe atingerea unui standard de reglementare sau a unui standard de concentrație a solului bazat pe risc. Cu toate acestea, prelevarea de probe de sol este costisitoare și potențial perturbatoare; în plus, urmărirea cu precizie a contaminării reziduale necesită analizarea unui număr mare de probe, deoarece solul, fiind un mediu neamestecat, este eterogen [USACE 2002]. Prin urmare, înainte de a începe un studiu de prelevare de probe de sol pe scară largă, se iau în considerare/monitorizează alți parametri (elemente de probă) pentru a evalua progresele înregistrate în materie de remediere și pentru a stabili dacă este probabil ca obiectivele de remediere să fi fost îndeplinite.

### 5.2.1 Posibile linii de dovezi care trebuie luate în considerare pentru confirmarea curățării

- Prelevarea de probe de sol: costisitoare și perturbatoare. Utilizarea prelevării de probe de sol pentru confirmarea curățării și a închiderii sistemului trebuie să ia în considerare cu atenție distribuția eterogenă a concentrațiilor din sol pe un sit și incertitudinile asociate cu prelevarea de probe de sol pentru COV [USACE 2002].
- Tendința concentrației de vapori extrasă: Concentrația de COV din sondele de extracție poate oferi un indicator al masei de contaminanți eliminați și o indicație a progresului remedierii. De obicei, după câteva luni de funcționare, tendința datelor arată un declin rapid, după care concentrațiile se apropie de nivelurile asimptotice (a se vedea Fig. 5.1 și Fig. 5.2). În multe cazuri, atingerea unei condiții asimptotice este considerată decisivă pentru stabilirea limitelor de performanță a tehnologiei și pentru închiderea sistemelor de aerisire. Cu toate acestea, observarea unor concentrații asimptotice scăzute de vapori în gazul efluent este o condiție necesară, dar nu și suficientă pentru a demonstra progresul în eliminarea masei din solurile contaminate. O asimptotă a efluentului poate fi, de fapt, legată de proiectarea sistemului de ventilație (de exemplu, spațierea sondelor) sau de condițiile de funcționare (de exemplu, debitul) separat sau în plus față de transportul de vapori limitat de viteză [EPA 2001].



Figura 5.1 – Tendințe în eliminarea masei de contaminanți (SVE), kg PCE/zi



Figura 5.2 – Tendințe în eliminarea masei de contaminanți (SVE), kg PCE (total de-a lungul timpului)

- Extracția vaporilor este mai eficientă în porțiunile de sol din apropierea sau dintre sonde care sunt bine spălate, prin urmare, concentrațiile de COV pot atinge niveluri asimptotice foarte scăzute, în timp ce o cantitate semnificativă de masă de contaminanți rămâne în sol, în special în apropierea zonelor de stagnare.
- În plus, atingerea nivelurilor asimptotice de concentrație în vaporii extrași poate însemna că, în timpul ventilației solului, are loc un transfer de masă cu viteză limitată. Dacă ratele de extracție a aerului depășesc rata de transfer de masă difuziv între fazele (solide, lichide și gazoase) din zona nesaturată, concentrațiile de contaminanți din vaporii extrași pot scădea fără a elimina toată masa de contaminanți din sol și din apa din pori [USACE 2002].
- Monitorizarea gazelor din sol: probele de gaze din sol sunt mai puțin costisitoare de colectat și, întrucât aerul este un mediu mixt, reprezintă, în general, date mai integrate (și anume, de pe o suprafață mai mare). Prin urmare, monitorizarea COV în sondele de gaze din sol este probabil o metodă mai eficientă și mai eficace pentru a evalua progresul remedierii decât cele descrise anterior la punctele a) și b). Cu toate acestea, eșantionarea gazelor din sol ar trebui să urmeze o procedură standard care să ia în considerare influența condițiilor de teren (de exemplu, litologia, umiditatea) și a parametrilor de eșantionare (de exemplu, debitul de eșantionare, volumul de eșantionare) asupra rezultatelor monitorizării. Sondele de gaze din sol ar trebui instalate, de asemenea, în zonele îndepărtate de sondele de extracție, mai dificil de remediat, pentru a urmări contaminarea reziduală.
- Revenire: în timpul fazei operaționale se observă, în general, o scădere a concentrațiilor de COV din gazele din sol ca urmare a transferului de masă cu viteză limitată (efect de foame) și a diluției cu aerul ambiant. Prin urmare, atunci când sistemul SVE este oprit, concentrațiile de COV pot crește din cauza difuziei între diferite faze și zone ale solului nesaturat. Acest fenomen, descris de obicei ca fenomen de revenire, poate fi

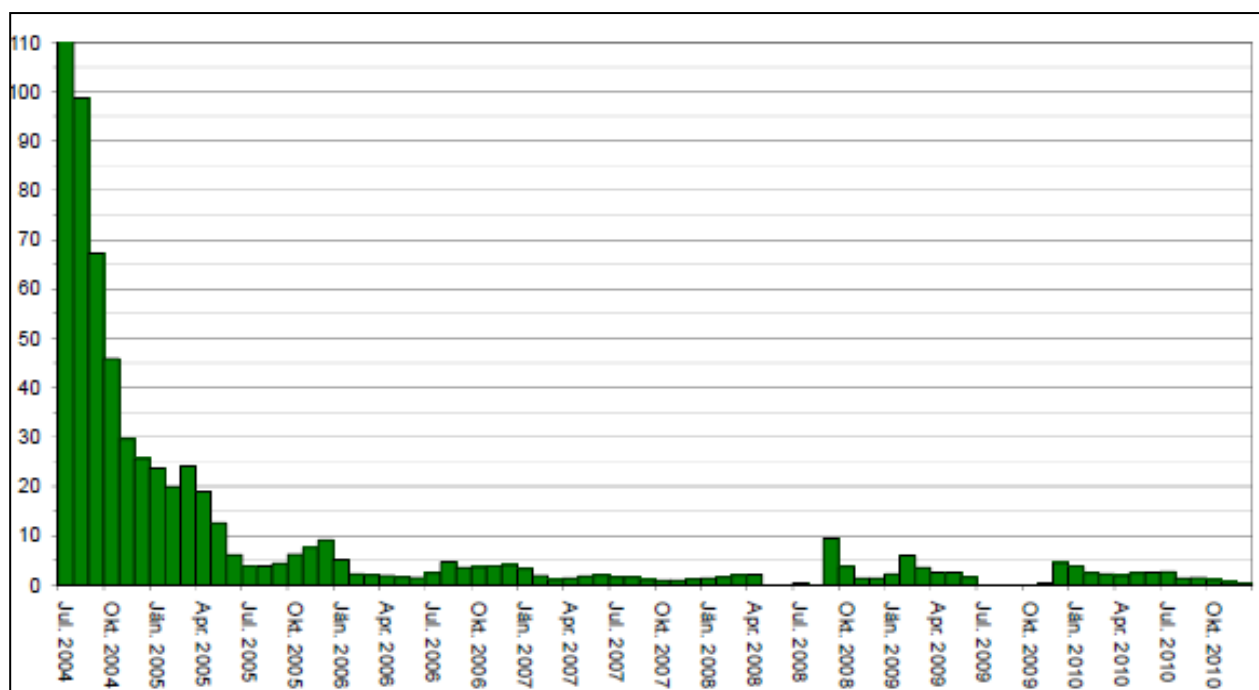
considerat un indicator fiabil al eficienței tratamentului. O revenire minimă sau lipsa de revenire, nici în zonele stagnante, după o anumită perioadă de oprire a sistemului indică faptul că masa disponibilă a fost probabil eliminată. Perioada de timp necesară pentru atingerea echilibrului este specifică contaminantului și tipului de sol. Solurile nisipoase vor ajunge în general la echilibru în câteva săptămâni, în timp ce pentru solurile cu straturi înalte pot fi necesare câteva luni. Se recomandă testarea anuală a echilibrului (revenire) [AFCEE 2001].

## 5.2.2 Procedura de eșantionare propusă pentru încheiere

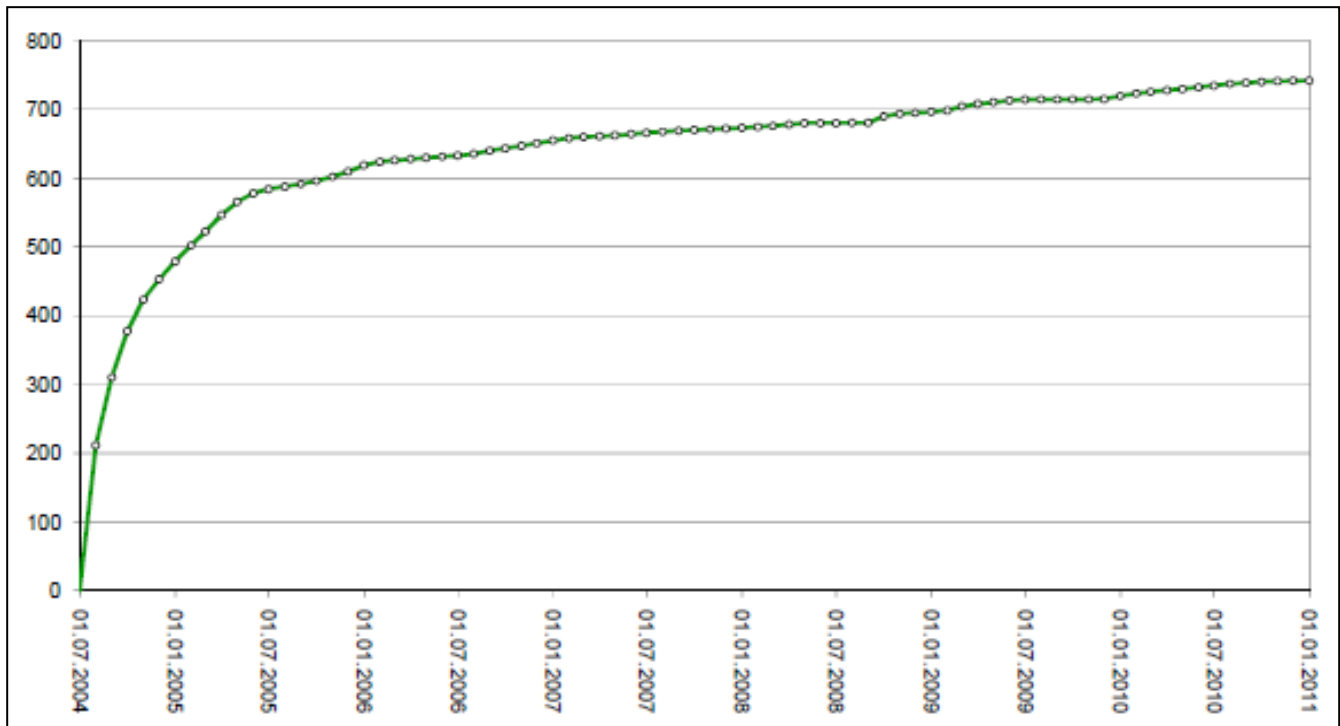
Criteriul final de închidere a unui sistem SVE se bazează de obicei pe atingerea unor standarde stabilite de concentrație a solului. Cu toate acestea, după cum s-a discutat anterior, deoarece prelevarea de probe de sol este atât costisitoare, cât și potențial perturbatoare, înainte de a începe un studiu de prelevare de probe de sol pe scară largă, se monitorizează alți parametri (linii de probe) pentru a evalua dacă este probabil ca obiectivele de remediere să fi fost îndeplinite. Prin urmare, se propune următoarea procedură de confirmare a curățării, bazată pe un proces de verificare în trei etape:

- atingerea unei concentrații țintă de gaze din sol în timpul fazei operaționale;
- atingerea unei concentrații țintă de gaze din sol după o oprire temporară a sistemului;
- compararea rezultatelor eșantionării solului cu criteriile de curățare.

## 6 CONCLUZII

Extracția vaporilor din sol (Soil Vapour Extraction - SVE) este o tehnică *in situ* care este adecvată pentru a reduce concentrația de contaminanți volatili din zona nesaturată.

În general, s-a demonstrat că SVE este eficientă în cazul compușilor organici volatili (COV) și ar putea sprijini remedierea compușilor organici semivolatili (SVOC). În cadrul unor proiecte specifice, atunci când se remediază situri contaminate cu solvenți clorurați, cum ar fi cloroetilenele (PCE și TCE), sau cu produse petroliere volatile, cum ar fi benzina, SVE se aplică adesea în combinație cu alte tehnologii.

### 6.1 Eficiență, avantaje și dezavantaje

Factorii cheie care determină eficiența SVE sunt:

- permeabilitatea aerului în sol (afectează cantitatea de aer și de vapori care se pot deplasa prin sol);
- structura și stratificarea solului (importante deoarece pot afecta modul în care vaporii circulă în sol în timpul extracției);
- umiditatea solului (poate limita fluxul de gaze prin pori);
- adâncimea pânzei freactice.

Principalele avantaje sunt:

- eficiență cunoscută, instrumente ușor de obținut, instalare simplă;
- perturbare redusă a activităților de pe șantier: proiectarea unui sistem SVE este destul de flexibilă pentru a fi adaptată la orice condiții de șantier și medii construite, precum și construcția este puțin intruzivă și se adaptează în mod comparabil;
- durată scurtă de tratare (6 luni - 2 ani în condiții optime): durata de tratare depinde în mare măsură de condițiile de pe amplasament, prin urmare, în comparație cu alte tehnologii, este relativ scurtă, putând dura de obicei de la câteva luni la câțiva ani, cu o eliminare efectivă a masei de până la 90% pentru compușii foarte volatili și de aproximativ 30-40% pentru compușii semivolatili;
- ușor de operat, relativ ieftin și rentabil în comparație cu alte tehnologii adecvate pentru remedierea contaminanților volatili (costuri competitive: aproximativ 15-60 EUR/tonă de sol contaminat);
- aplicabilă la situri cu produse libere, poate fi combinată cu alte tehnologii. Vidul indus în straturile de sol controlează și migrația subterană a vaporilor și protejează clădirile, precum și infrastructurile subterane împotriva pătrunderii contaminanților volatili inflamabili sau toxici.

Principalele limitări sunt:

- dificultatea obținerii unor reduceri de concentrație a contaminanților de peste 90%;
- eficiență redusă în siturile cu permeabilitate scăzută sau în cazul solurilor stratificate eterogene.

## 6.1 Control operațional pentru aplicarea SVE

Printre principalele verificări preliminare care trebuie efectuate pentru a evalua aplicabilitatea tehnologiei, trebuie definite caracteristicile geometrice, litologice și hidrogeologice ale mediului nesaturat și trebuie să se evalueze orice creștere sau scădere a nivelului freatic. Atunci când se ia în considerare o delimitare tridimensională a zonei nesaturate care urmează să fie tratată, este utilă, în cele din urmă, estimarea masei totale a contaminantului (contaminanților) de interes înainte de remediere pentru a permite o comparație cu ratele de îndepărtare a masei, cu modificările eficienței în timp și cu îndepărtarea masei totale la terminarea aplicației.

Printre parametrii care trebuie verificați în timpul construcției, cei mai importanți sunt: raza de influență (R) și raza de tratament (ROT). Alți parametri care trebuie verificați și care influențează funcționarea sunt: fluctuațiile nivelului apelor subterane, sistemele de admisie a aerului, eficiența în timp a sistemului de tratare a gazelor extrase, înainte de eliberarea lor în atmosferă. Sistemul trebuie ținut sub control în timpul funcționării sale, inclusiv pentru a determina momentul potrivit pentru încetarea tratamentului.

La sfârșitul intervenției de remediere prin SVE, este necesar să se procedeze la unele verificări pentru a evalua posibila încheiere a intervenției. În acest scop, este necesar ca operatorul să evalueze o serie de informații și să prezinte autorităților un raport privind starea de mediu constatată în urma studiilor efectuate, iar apoi să prezinte autorităților toate elementele utile pentru a verifica încrucișat dacă remedierea și-a atins obiectivele.

## BIBLIOGRAFIE

*Documentele sunt citate în ordine alfabetică, după cum urmează: [Autorul/ autorii, Anul, Titlul, #]*

- AFCEE, 2001. United States Air Force Environmental Restoration Program: Guidance on Soil Vapor Extraction Optimization. Air Force Center for Environmental Excellence, Brooks Air Force Base, Texas. Last accessed July 17, 2012, at <http://www.dtic.mil/docs/citations/ADA392205>;
- Air Sparging: Technology Transfer and Multi-Site Evaluation ESTCP Project ER-9808, freely downloadable at <https://www.serdp-estcp.org/content/download/3734/59418/file/ER-9808%20Design%20Paradigm.pdf>
- Analysis of Selected Enhancements for Soil Vapor Extraction, September 1997, EPA-542-R-97-007, consulted at <https://clu-in.org/download/remed/sveenhmt.pdf>
- Baker, R. S., and Wiseman, J. T. 1992. Importance of vadose zone monitoring during soil vapor extraction pilot studies. Proceedings: International Symposium on In Situ Treatment of Contaminated Soil and Water. Cincinnati, OH. February 3-6, 1992. Air and Waste Management Association, pp. 26-41.
- Ball, R., and Wolf, S. 1990. Design considerations for soil cleanup by soil vapor extraction. Environmental Progress. 9(3):187-90
- Breckenridge, R. P., Williams, J. R., and Keck, J. F. 1991. Characterizing Soils for Hazardous Waste Site Assessments. Ground-Water Issue, EPA/540/4-91/003, Office of Research and Development, Office of Solid Waste and Emergency Response.
- CalEPA, 2015: California Environmental Protection Agency, Advisory – Active Soil Gas Investigations, Department of Toxic Substances Control.
- Davies, S. H. 1989. The influence of soil characteristics on the sorption of organic vapors. The Workshop on Soil Vacuum Extraction. R.S. Kerr Environmental Research Laboratory, Ada, OK. April 27-28, 1989.
- DiGiulio, D.C., and R. Varahan. 2001a. Limitations of ROI testing for venting design: description of an alternative approach based on attainment of a critical pore-gas velocity in contaminated media. Ground Water Monitoring & Remediation 21(1): 97-114.
- Engineering Issue: Soil Vapor Extraction (SVE) Technology, February 2018, EPA/600/R-18/053, consulted at [https://cfpub.epa.gov/si/si\\_public\\_file\\_download.cfm?p\\_download\\_id=538425&Lab=NRML](https://cfpub.epa.gov/si/si_public_file_download.cfm?p_download_id=538425&Lab=NRML).
- Farallon consulting, Final capital industries plant 4soil vapor extraction pilot study work plan freely downloadable at <https://www.farallonconsulting.com/wp-content/uploads/2020/09/2019-Final-SVE-Pilot-Study-WP.pdf>
- Freeze, R. A., and Cherry, J. A. 1979. Groundwater. Prentice Hall, Englewood Cliffs, NJ. 604 pp.
- FRTR Technology Screening Matrix: Thermal Treatment, March 2020, consulted at <https://frtr.gov/matrix2/section4/4-9.html>.
- Interim Final. Directive 9234.2-25, September 1993. OSWER. Washington, DC. 26 pp.
- Johnson, Jeffrey, DeWitt, Christopher B., Wolfe, Bryan, and Mark Garman. 1999. Moisture and Ammonia-Enhanced Bioventing in Arid Environments, abstract, in "Proceedings of the Fifth International Symposium on In-Situ and On-Site Bioremediation, San Diego, CA, April 19-22, 1999"
- Jury, W. A., Winer, A. M., Spencer, W. F., and Focht, D. D. 1987. Transport and transformations of organic chemicals in the soil-air-water ecosystem. Reviews of Environmental Contamination and Toxicology. 99:120-64.
- Kuang et al., 2013 Review on airflow in unsaturated zones induced by natural forcings. Water Resour. Res., 49 (2013), pp. 6137-6165
- Minnesota Pollution Control Agency Voluntary Investigation and Cleanup Design Criteria and Reporting Requirements Guidance Document #17 (Vapor Extraction, Air Sparging), freely downloadable at <https://www.pca.state.mn.us/sites/default/files/vic-gd17.pdf>
- PNNL. SVE System Operation, Transition, and Closure Guidance (2013)
- RAE System, 2013 The PID handbook. Theory and Applications of Direct-Reading Photoionization



Detectors, ISBN: 0-9768162-1-0

- Soares, A.A., Pinho, M.T., Albergaria, J.T. et al. Sequential Application of Soil Vapor Extraction and Bioremediation Processes for the Remediation of Ethylbenzene-Contaminated Soils. *Water Air Soil Pollut* 223, 2601–2609 (2012).
- Soil Vapor Extraction (SVE) treatment technology resource guide, September 1994, EPA/542-B-94-007, freely downloadable at [https://www.epa.gov/sites/production/files/2015-08/documents/sve\\_tt\\_res\\_guide.pdf](https://www.epa.gov/sites/production/files/2015-08/documents/sve_tt_res_guide.pdf)
- State of Florida, Soil Vapor Extraction Pilot Test Guidance <https://floridadep.gov/sites/default/files/BPSS12B-SVEGuidance.pdf>
- Suthersan, S. S. (1999). Soil vapour extraction. In *Remediation engineering: Design concepts* (pp. 27–88). Boca Raton: Lewis Publisher Inc.
- The SVE Pilot Test, consulted 16/03/2021 at <https://www.enviroequipment.com/blog/soil-vapor-extraction-sve-pilot-test>
- Truex, M. J., D. J. Becker, M. A. Simon, M. Oostrom, A. K. Rice, AND C. D. Johnson. *Soil Vapor Extraction System Optimization, Transition, and Closure Guidance*, PNNL-21843. U.S. Department of Energy, Washington, DC, 2013.
- USACE. 2002. *Engineering and Design: Soil Vapor Extraction and Bioventing*. EM 1110-1-4001, U.S. Army Corps of Engineers, Washington, D.C. Last accessed July 17, 2012, at [http://publications.usace.army.mil/publications/eng-manuals/EM\\_1110-1-4001\\_sec/toc.htm](http://publications.usace.army.mil/publications/eng-manuals/EM_1110-1-4001_sec/toc.htm)
- USAF. *Guidance on Soil Vapor Extraction Optimization* (2001)
- US EPA. 2001. *Development of Recommendations and Methods to Support Assessment of Soil Venting Performance and Closure*. EPA/600/R-01/070, U.S. Environmental Protection Agency, Washington, D.C.
- USEPA. 1991h. *Description and Sampling of Contaminated Soils, A Field Pocket Guide*. EPA 625/12-91/002, Center for Environmental Research Information, Cincinnati, OH.
- USEPA. 1989c. *Laboratory Investigation of Residual Liquid Organics from Spills, Leaks, and the Disposal of Hazardous Wastes in Groundwater*. EPA/600/6-90/004. New Mexico Institute of Mining and Technology, Socorro, NM.
- USEPA. 1993g. *Guidance for Evaluating the Technical Impracticability of Ground-Water Restoration*.



European Union Network for the Implementation  
and Enforcement of Environmental Law

# Annex 1

---

## Soil Vapour Extraction – Case studies

IMPEL Project no. 2020/09



## 1. Contact details - CASE STUDY: SVE n.1

<b>1.1 Name and Surname</b>	Aline Jordens, Mathieu Petitjean, Hatem Saadaoui, Jan Haemers
<b>1.2 Country/Jurisdiction</b>	Belgium
<b>1.3 Organisation</b>	Haemers Technologies
<b>1.4 Position</b>	Innovation Engineer
<b>1.5 Duties</b>	R&D
<b>1.6 Email address</b>	<a href="mailto:innovation@haemers-tech.com">innovation@haemers-tech.com</a>
<b>1.7 Phone number</b>	+32 2 786 39 43



## 2. Site background

### 2.1 History of the site

The site is located in the military airbase of Biên Hòa, Dong Nai, Vietnam.

During the US-Vietnam War (1955-1975), millions of litres of herbicides were dropped over Vietnam: The Rainbow agents. Those Rainbow Agents were sprayed throughout the Operation Ranch Hand to clear thick jungle, by defoliating crops and forest. Bien Hoa Airbase was a joint operating base for the South Vietnam Air Force and the United States Air Force. According to the U.S. Department of Defense, 98 000 barrels of Agent Orange, 45 000 barrels of Agent White and 16 000 barrels of Agent Blue were stored at Bien Hoa Airbase [1].

As a consequence, the Biên Hòa airbase is currently the largest dioxin hotspot in Vietnam [2].

Nowadays, it is estimated that between 408,500 and 495,300 m<sup>3</sup> of dioxin-contaminated soil and sediment are present in the site [3]. This is almost 4 times the volume of the last airbase that underwent treatment (Danang).

More than four decades after the Vietnam War ended (in 1975), the stability and bioaccumulation of dioxins still affect the inhabitants. Measures had to be taken to improve living conditions for residents, starting with the remediation of dioxin contaminated soil. In 2018, at the request of the Government of Vietnam (GVN), the U.S. Government agreed to cooperate on dioxin remediation at Bien Hoa Airbase Area. Haemers Technologies was invited to perform a pilot remediation in the process of the technology selection for the full-scale project.

[1] DOD. 2007. Presentation made at the Second Agent Orange and Dioxin Remediation Workshop, Hanoi, Vietnam, June 18-19, 2007. Co-sponsored by U.S. Department of Defense and Vietnam Ministry of National Defense.

[2]: USAID, FACT SHEET: DIOXIN REMEDIATION AT BIEN HOA AIRBASE AREA, consulted 16/12/2020, <https://www.usaid.gov/vietnam/documents/fact-sheet-dioxin-remediation-bien-hoa-airbase-area>

[3] USAID. 2016. Environmental Assessment of dioxin contamination at Bien Hoa Airbase

## 2.2 Geological setting

There are mainly two types of soils that need to be remediated : low-humidity soil as well as high-humidity muds from swamp-like areas.





## 2.3 Contaminants of concern

Agent Orange was proven to cause severe health issues, including birth defects, neurological problems and cancers. Agent Orange is a mixture of 2,4-dichlorophenoxyacetic acid and 2,4,5-trichlorophenoxyacetic. Traces of dioxins were also found in some Agents. Indeed, dioxin 2,3,7,8-Tetrachlorodibenzo-p-dioxin (2,3,7,8-TCDD) can be formed by condensation of 2,4,5-trichlorophenol during 2,4,5-trichlorophenoxyacetic synthesis.

Hereafter is shown the breakdown of a sample taken from the site (Contaminated sample column). The “treated sample” column refers to the sample after a lab test. The increase in secondary contaminants after treatment is most likely due to the sample heterogeneity.



	<i>Contaminated sample</i>	<i>Treated sample</i>	<i>Unit</i>
<b>Dry matter</b>	<b>94,9</b>	<b>99,7</b>	<b>% (dry matter mass)</b>
2,3,7,8-Tétra CDD	2800	630	ng/kg DM
1,2,3,7,8-PentaCDD	14	84	ng/kg DM
1,2,3,7,8,9-Hexa CDD	13	27	ng/kg DM
1,2,3,6,7,8-HexaCDD	20	42	ng/kg DM
1,2,3,4,7,8 -Hexa CDD	3,5	7,5	ng/kg DM
1,2,3,4,7,8,9-Hepta CDD	99	46	ng/kg DM
Octa CDD	450	200	ng/kg DM
1,2,3,7,8 Penta CDF	1,7	3,2	ng/kg DM
2,3,4,7,8-Penta CDF	1,2	2,8	ng/kg DM
2,3,7,8-Tétra CDF	75	28	ng/kg DM
1,2,3,7,8,9 - Hexa CDF	<1,0	<1,0	ng/kg DM
2,3,4,6,7,8 - Hexa CDF	2,3	1,9	ng/kg DM
1,2,3,4,7,8 Hexa CDF	1,5	2,0	ng/kg DM
1,2,3,6,7,8 Hexa CDF	<1,0	1,4	ng/kg DM
1,2,3,4,7,8,9 -Hepta CDF	<5,0	<5,0	ng/kg DM
1,2,3,4,6,7,8 -Hepta CDF	9,4	<5,0	ng/kg DM
Octa CDF	<10	<10	ng/kg DM
I-TEQ-PCDD/F-OTAN/CCMS (lower limit)	2820 <sup>4</sup>	685	ng/kg DM
I-TEQ-PCDD/F-OMS 1998 (lower limit)	2830 <sup>4</sup>	727	ng/kg DM
I-TEQ-PCDD/F-OMS 2005 (lower limit)	2830 <sup>4</sup>	726	ng/kg DM
I-TEQ-PCDD/F-OTAN/CCMS (upper limit)	2820 <sup>5</sup>	685	ng/kg DM
I-TEQ-PCDD/F-OMS 1998 (upper limit)	2830 <sup>5</sup>	727	ng/kg DM
I-TEQ-PCDD/F-OMS 2005 (upper limit)	2830 <sup>5</sup>	727	ng/kg DM



## 2.4 Regulatory framework

Haemers Technologies was invited by the Vietnam Government to perform a pilot project in the context of the technology selection for the Bien Hoa airbase remediation led by USAID and GVN.

The soil concentration limits after treatment have been defined as following:

- Industrial use: 1,200 ppt
- Urban area: 300 ppt
- Sediment: 150 ppt



## 3. Pilot-scale application in field

### 3.1 Extraction system

The treatment proposed by Haemers Technologies is a thermopile (ex-site thermal treatment). The thermopile is a small pilot-scale pile of 500 tons (11m x 14m at its base). In a thermopile, the soil is heated by conduction until it reaches the temperature of volatilization of the pollutants (a process known as thermal desorption). The vapours are then extracted to be treated. In the pile are installed 15 heating tubes and 13 exchanger tubes that transfer thermal energy to the soil. The vapours are extracted by 15 perforated tubes that are connected to a 15 kW blower in order to generate a low but constant depression sucking the gasses out. The typical depression generated is in the order of -0.2 mbar.

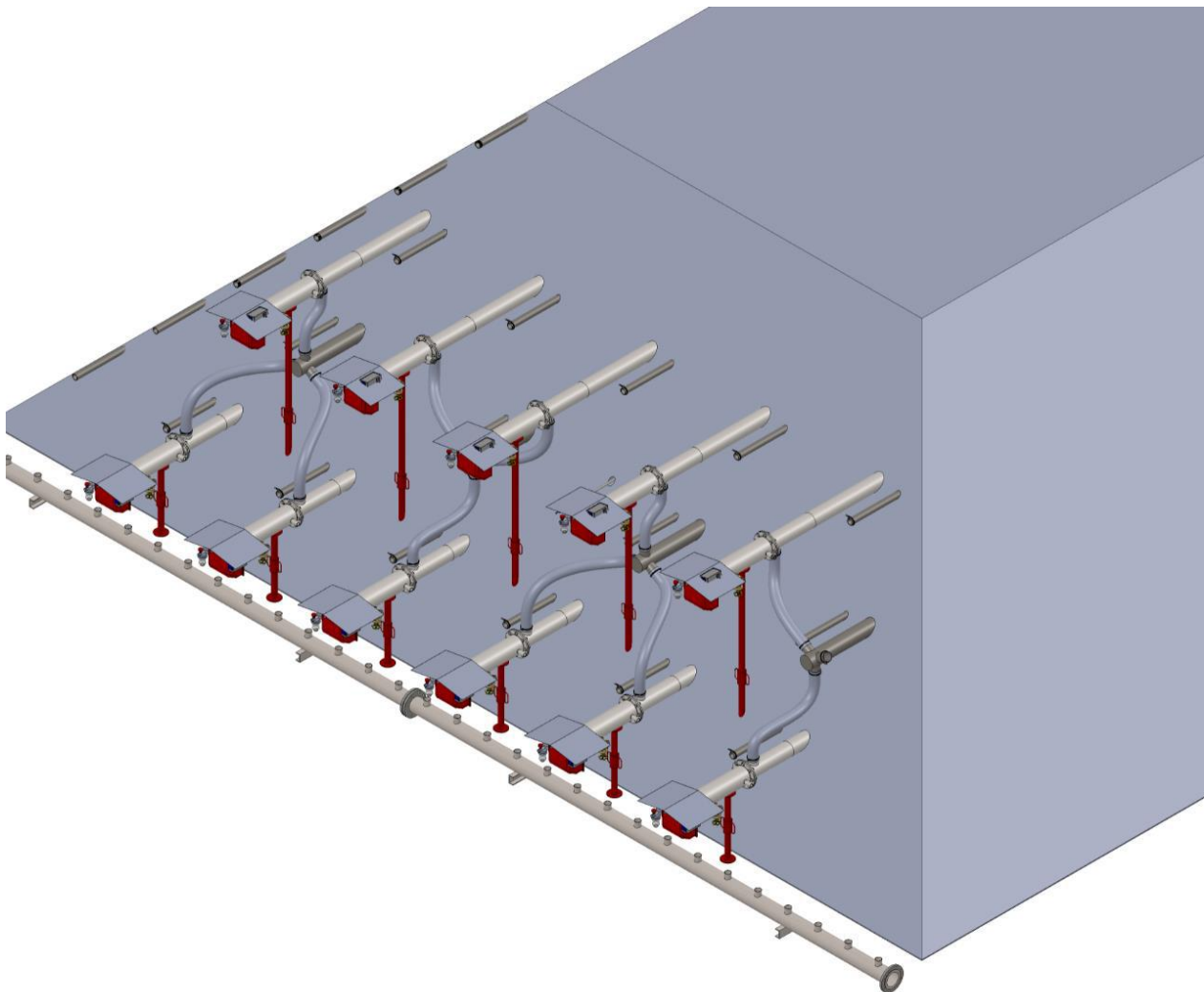



## 3.2 Injection system

In thermal desorption treatment, there is no injection system. The gases are generated when the contaminants and the water are vaporized due to the thermal energy transfer.

## 3.3 Radius of influence

The treatment is effective on the whole pile. Lab tests have shown that if the soil reaches 350°C and that the temperature is maintained for at least 5 days, the target treatment concentrations are met.

The main factor of influence is the interdistance between heating wells in the pile, but they only affect the **heating time**, i.e. the time needed to reach 350°C. The treatment effectiveness is unchanged.

In this case, the soil vapour extraction wells are approx 1.2m apart. This short range is not the actual radius of influence of each well, as this radius varies in the course of the treatment. As temperature increases, soil is drying out, affecting the permeability to vapours. Therefore, the actual radius of influence of each pipe is likely much larger than 1.2m, even if the applied negative pressure is very low (in the order of 0.2mbar). E The high density of soil vapour extraction wells is commanded by the necessity to collect all vapours despite the low negative pressure and avoid fugitive emissions.

### 3.4 Off gas Treatment

The contaminated vapours are sucked from the pile and transit through the Vapor Treatment Unit (VTU). Contrary the approach taken by USAID at Danang which used activated carbon, Haemers Technologies uses a Thermal Oxidizer in order not to leave any waste requiring further treatment.

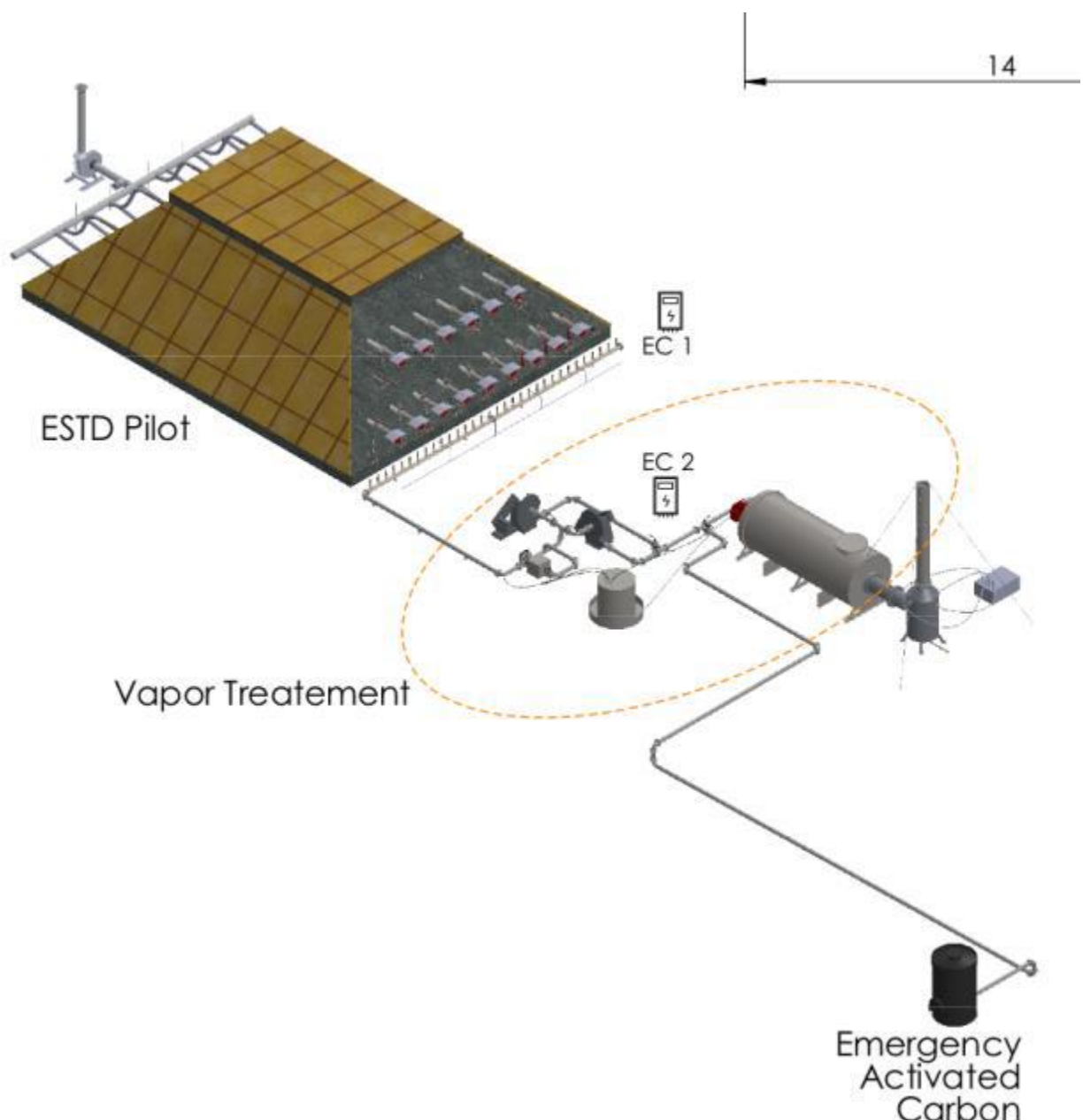

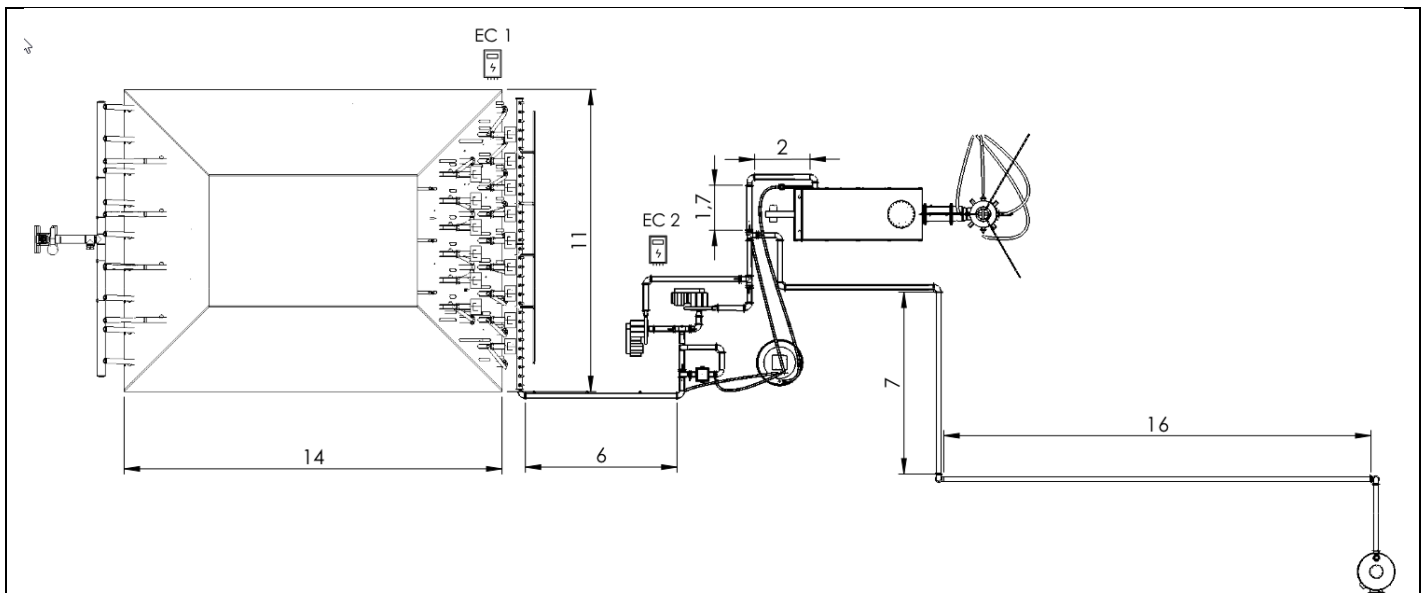

Before entering the Thermal Oxidizer, the vapours may circulate through an Arsenic filter if needed.

The vapours are then directly incinerated in order to destroy all PCDD and PCDF's. Proper oxidation guarantees compliant air emissions. It has to be noted that condensation will certainly happen along the network. To reduce liquid formation, the network is thermally insulated. Nevertheless, the liquid formed can be reinjected in the Thermal Oxidizer. To reach a destruction rate efficiency over 99,99%, the following criteria must be fulfilled in the oxidation chamber [4][5]:

1. Temperature of minimum 1100°C (preferably 1200°C)
2. Oxygen content of min 6% (preferably 10%)
3. Residence time of minimum 1 second (preferably 2 seconds)
4. High Turbulence ( $Re \gg 2500$ ).

It is well known that dioxin compounds reformation can happen in the cooling phase, in a temperature range between 200°C and 500°C. Dioxins can be reformed in the presence of oxygen, chlorine ( $Cl_2$ ) and hydrocarbons [6]. Other parameters such as presence of dust and/or presence of metals, can also promote the dioxins/furans formation. To avoid the reformation process, the vapours are directed towards a cooling quench tower to a temperature below 180°C before being released in the atmosphere.

In case of issue, a back-up activated carbon tank is also present.

[4] Gao, Y. &. (2015). Assessment of Reynolds Averaged Navier–Stokes Modeling of Scalar Dissipation Rate Transport in Turbulent Oblique Premixed Flames. *Combustion Science and Technology*, 18

[5] Jacob E. Temme, T. M. (2015). Measurements of Premixed Turbulent Combustion Regimes of High Reynolds Number Flames. 53rd AIAA Aerospace Sciences Meeting (p. 21). Kissimmee, Florida : AIAA SciTech Forum.

[6] Buekens, A. (2001). Dioxins from thermal and metallurgical processes: recent studies for the iron and steel industry,. *Chemosphere* 42, 729-735.



### **3.5 Control parameters**

Of course, the dioxin content in the soil is analyzed before and after treatment to assess the treatment effectiveness. However, thermal desorption has already been implemented at the Danang airport and has been proved to be effective against dioxin contamination.

The parameters that are continuously monitored during the treatment are the following:

- The temperature at the coldest points in the thermopiles
- The emissions at all chimneys to guarantee regulatory compliance
- The depression in the pile to ensure proper extraction
- The temperature in the Thermal Oxidizer
- The oxygen content in the Thermal Oxidizer
- The temperature of gases at the quench tower output to avoid dioxin reformation

## **4. Full-scale application**

The pilot project was interrupted by the Covid-19 pandemic and the full-scale application has not started yet.

## **5. Enhancements to SVE**

### **5.2 Any other enhancement**

The Thermal Oxidizer in combination with a heat exchanger can be used to improve the overall thermal efficiency of the thermal desorption process by recovering energy and preheating the combustion air and the vapours themselves.

## **6. Post treatment and/or Long Term Monitoring**

### **6.1 Post treatment and/or Long Term Monitoring**

Post treatment monitoring consists of soil analysis.

Monitoring is based on the extracted vapours as well as temperatures inside the soil.



## 7. Additional information

### 7.1 Lesson learnt

The biggest hurdle in this project was the heavy burden of procedures and authorizations required to perform the actual projects, due to the high sensitivity of the site with respect to its danger and history, as well as the military control over all operations.

### 7.2 Additional information

Even if the project is not finished, it has already been established that thermal desorption is effective against dioxin contamination. The addition of a Thermal Oxidizer improves the Danag process, given that:

- Soil is indeed treated according to standards
- The exhaust gas after thermal oxidation are compliant (no reformation of dioxin)
- No solid nor liquid waste is generated, not needed further off-site disposal

### 7.3 Training need

Training needs are specific both the heating and extraction system, as well as to the Health and Safety measures to be taken on site.

Additional communication is required given the nature of the contaminants in order to fully inform operators and local community about the safety of the process for their own health.

## Glossary of Terms

Term (alphabetical order)	Definition
VTU Vapor Treatment Unit	VTU Vapor Treatment Unit
ppt	part-per-thousand

## 1. Contact details - CASE STUDY: SVE n.2

<b>1.1 Name and Surname</b>	Jean Rhone, Mathieu Petitjean, Alain Duchene, Hatem Saadaoui, Jan Haemers
<b>1.2 Country/Jurisdiction</b>	Belgium
<b>1.3 Organisation</b>	Haemers Technologies
<b>1.4 Position</b>	Innovation Engineer
<b>1.5 Duties</b>	R&D
<b>1.6 Email address</b>	<a href="mailto:innovation@haemers-tech.com">innovation@haemers-tech.com</a>
<b>1.7 Phone number</b>	+32 2 786 39 43

## 2. Site background

### 2.1 History of the site

The site is located in the North of France. It used to be a manufacturing site producing different chemicals, acids and catalysers. Many soil and water investigations were carried out from 1998 to 2015. They showed a presence of impacts of many pollutants in multiple spots of the 0.32 km<sup>2</sup>. The results of those analyses were not different from classic industrial pollution and the main pollutants found were hydrocarbons, BTEX, PAH and heavy metals. The site is located next to agricultural fields and the soil is mainly made of backfills and loam. Once the analyses confirmed the concentrated polluted spots, a “Plan de Gestion” (remediation plan) was drafted, leading to various site uses and different remediation target concentrations.

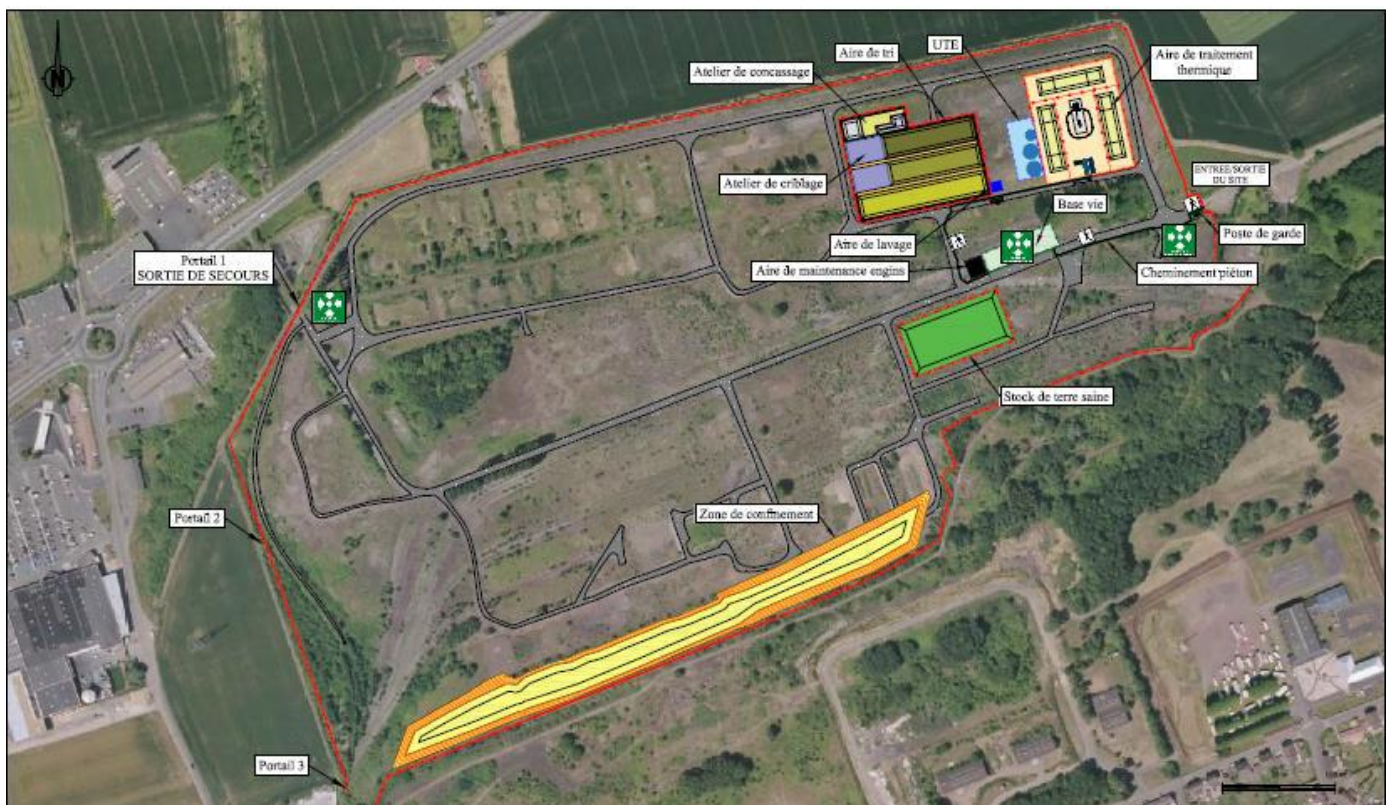





## 2.2 Geological setting

The whole site covers about 34 hectares. It is located between a commercial area and an agricultural area. Indeed, agricultural fields are present at North and East of the site. The main issue with high concentrated spots on a large area is the difficulty to treat all the spots onsite and therefore an Ex-Situ Thermal Desorption (ESTD) was selected. Soils with hydrocarbons concentrations higher than the remediation target were excavated and stored in a single location and eventually erected in several polluted soil piles.

Item	Value	Units
Average Soil Density	1.8	kg/m <sup>3</sup>
Average Porosity	0,3	$V_v/V_T$
Moisture Content	0,24	$\frac{W_{water}}{W_{soil}}$

The thermal treatment area is isolated from groundwater with a waterproof geotextile placed at a depth of 0.4 m. The site's topography was designed to have no accumulation of rainwater in the area. Slight slopes were designed and a rainwater collecting system was constructed to send the rainwater to the water treatment plant.



## 2.3 Contaminants of concern

The contaminants are the COCs identified hereafter:

Contaminant Type	Number of samples	Average concentration (mg/kg DM)	Targets (mg/kg DM)	
C <sub>5</sub> -C <sub>10</sub>			Clay/loam	250
			Backfill	100
C <sub>5</sub> -C <sub>40</sub>	218	4145,5	Clay/loam	2000
			Backfill	1000
BTEX	218	1,16	Benzene	1,5
			Toluene	5
			Ethylbenzene	10
			Xylene	40
HAP	218	30,3	50	

Soils with hydrocarbons concentrations higher than the remediation target were excavated and stored in a single location and eventually erected in several polluted soil piles. The treatment area was chosen to be able to run 2 piles simultaneously, with a third one in mobilization/demobilization.

Because of the client's concern about Mercury (Hg) soil concentration, a classic ESTD treatment was chosen with the addition of an ad-hoc Vapor Treatment Unit situated at in the middle of the treatment area.

## 2.4 Regulatory framework

The site has been owned by different companies over the course of the last century. A prefectural order was issued in 2015 for the soil remediation in the context of a remediation plan (one commercial and activity area and one park and walking area). The owner issued Golder Associates to be the prime contractor. The contractor chosen by Golder Associates was Seché EcoService, which partnered with Haemers Technologies.

### 3. Pilot-scale application in field

No pilot-scale application was performed

### 4. Full-scale application

#### 4.1 Extraction system

The treatment proposed by Haemers Technologies is a rotating thermopile (ex-situ thermal treatment). Each pile consists of 2000m<sup>3</sup> of polluted soil. In the pile are installed 75 heating tubes and 25 exchanger tubes that transfer thermal energy to the soil. The vapours are extracted by perforated tubes that are connected to a blower in order to generate a low but constant depression sucking the gas out. The typical generated depression is in the order of -0.2 mbar.

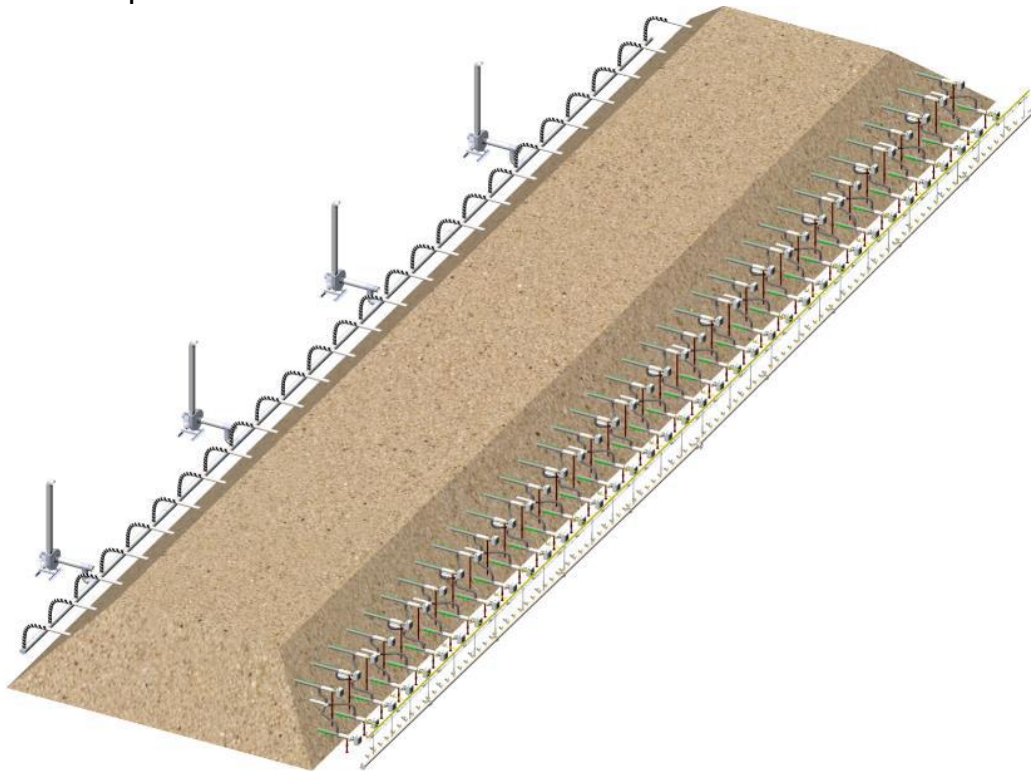



## 4.2 Injection system

In thermal desorption treatment, there is no injection system. The gases are generated when the contaminants and the water are vaporized due to the thermal energy transfer.

## 4.3 Radius of influence

The treatment is effective on the whole pile. Lab tests have shown that if the soil reaches 200°C and that the temperature is maintained for at least 3 days, the target treatment concentrations are met.

The main factor of influence is the interdistance between heating wells in the pile, but they only affect the heating time, i.e. the time needed to reach 200°C. The treatment effectiveness is unchanged.

In this case, the soil vapour extraction wells are approx 1.5m apart. This short range is not the actual radius of influence of each well, as this radius varies in the course of the treatment. As temperature increases, soil is drying out, affecting the permeability to vapours. Therefore, the actual radius of influence of each pipe is likely much larger than 1.5m, even if the applied negative pressure is very low (in the order of 0.2mbar).

The high density of soil vapour extraction wells is commanded by the necessity to collect all vapours despite the low negative pressure and avoid fugitive emissions.

## 4.4 Off gas Treatment

The contaminated vapours are sucked from the pile and transit through the Vapor Treatment Unit (VTU). The VTU is able to handle the off gases of two simultaneous piles. This way, a rotating schedule was implemented where two piles are in treatment while the third is dismantled and the next one is built.

The VTU aims to treat the contaminant's vapours coming from the piles' treatment to stay within national environmental release norms. The VTU is composed of various elements designed to achieve the treatment. Most of the VTU's installation is focused on the contaminant's vapours suction and condensation. The other part is focused on direct treatment through adsorption or thermal oxidation.

The following Figure presents the contaminated vapours flow from the Pile to the VTU.

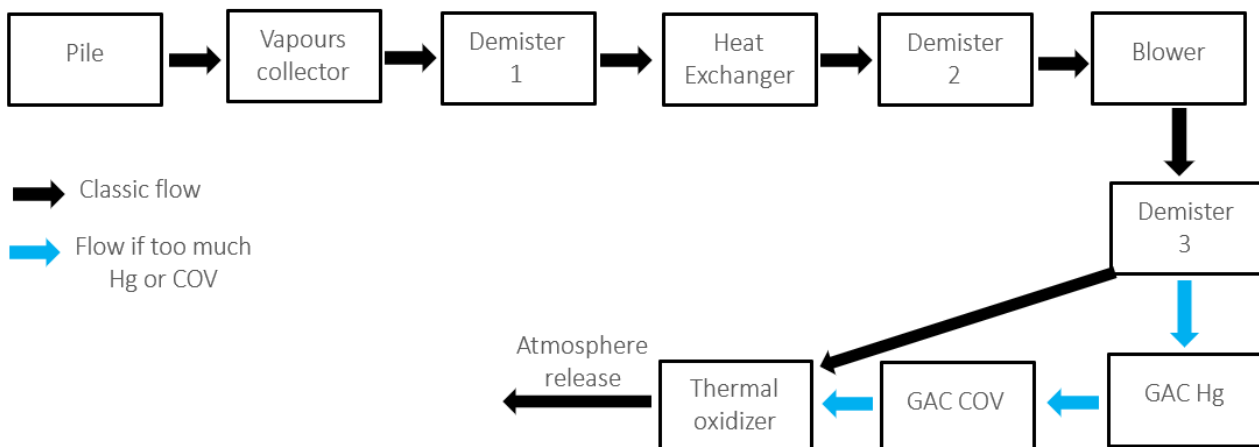

The VTU consists of three demisters and a heat exchanger. The non-condensable vapours (mainly air and light hydrocarbons) are sent to a thermal oxidizer (operating at 820°C), with a residence time of 2 seconds. If high concentration of Mercury is detected, the vapours are routed to a sulphured Activated carbon filter.

The process is partly duplicated to be able to continue the thermal treatment during maintenance of each VTU element. A Programmable Logic Controller was used to automate the switch between the two line.

The next figure will show the duplicated VTU scheme.

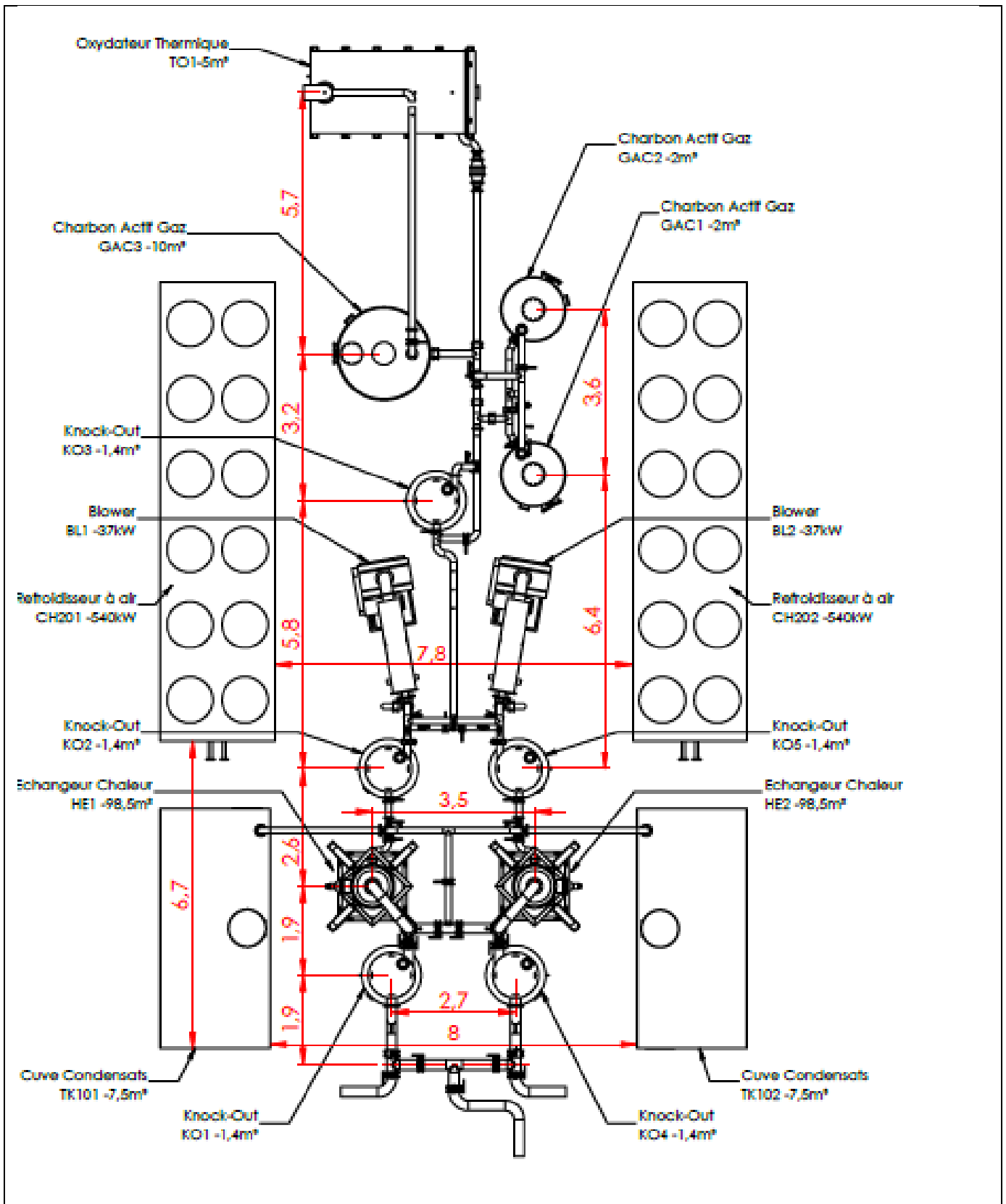

### Vapours collector

One 5" vapour collector was built for each pile. It was made of 10 sections of 6 meters

each. Each collector has a low cant in order to collect the condensates. The collector is connected to an underground tank. Vapour flexible are connected to the collector as shown in the next picture.



The underground tank is connected to an 8" vapour collector that goes to the VTU as shown in the next picture.



Water collected on the underground tanks is sent to the condensate tanks.

## Demisters

A demister equipment is made to remove liquid droplets from gases. Condensates are collected at the bottom of the tank and sent to be treated by Seché ES. One demister is placed at the VTU entry in order to remove the droplets formed on the 8" collector. One is then placed after the heat exchanger to remove the droplets formed during the vapours' cooling. The final demister is placed after the blower. Indeed, pressure changes in the blower can also create droplets. The aim was to remove humidity before entering the thermal oxidizer.

## Heat exchanger

Installation of one heat exchanger was mandatory for two main reasons: vapour cooling before the blower, water removal using condensation process. In a tubular exchanger, vapours pass through copper thin pipes and gets cool down by water passing between the pipes. Each of the heat exchanger has a 98.5 m<sup>2</sup> exchange surface. Water is then cooled down using a dry air cooler (540 kW). Glycol was added to the water to prevent freezing during winter. The next pictures show the heat exchanger and the dry air cooler.



## Blower

The blower is the most important part of the VTU. Its aim is to depressurize the pile by vacuuming the air and the contaminated vapours. Each of the two blowers was designed to vacuum two piles simultaneously. Thus, each blower has a maximum flow capacity of 3,200 m<sup>3</sup>/h. They are set using one frequency regulator. The maximum acceptable temperature at the input is set to 80°C. The next picture shows one blower.





### **GAC Hg**

Mercury traces were found in previous soil analysis. Exxon suggested Haemers Technologies to provide a solution in order to prevent any mercury atmospheric releases. Two sulphurous activated carbon tanks of 3 m<sup>3</sup> and one Hg analyser (VM-3000) were added to the VTU. The aim was to analyse the vapours after the blower in order to know the mercury concentration. If the concentration was over the norms, an electrovalve redirected the vapour flow to the activated carbon. Another sampling point was placed after the activated carbon in order to assess the mercury removal. The chosen activated coal has an apparent density of 0.63 kg/l and a sulphur concentration of 13-16%. The following picture shows the mercury tanks.

### **GAC COV**

Vapours should be treated through the thermal oxidizer. However, in case of thermal oxidizer breakdown, an activated coal tank of 10 m<sup>3</sup> was added. In case of thermal oxidizer breakdown, the flow was redirected to this new tank. The outlet was connected to the thermal oxidizer's chimney. An activated coal with the following specifications was chosen: apparent density of 0.475 kg/l and US Standard Mesh granulometry of 4\*8. It was chosen to remove COV from the vapours. The following picture shows the tank and its chimney connection.



### Thermal oxidizer

The thermal oxidizer is the key equipment for the vapour treatment. Indeed, the other equipment (except for the GACs) were not chosen for the hydrocarbons removal but mainly to remove the water from the vapours for a better thermal oxidation. Its aim was to remove the pollutants from the vapours and to release clean gases. A residency time of minimum 2 seconds was calculated in order to have an efficient pollutants thermal oxidation. The thermal oxidizer is 5 m<sup>3</sup> and has a 3 meters chimney. It is designed to resist to a maximal temperature of 1,000 °C. A 850 kW burner is connected to the thermal oxidation chamber and fuelled with gas. The burner power is regulated depending on the temperature inside the thermal oxidizer. The normal conditions to have the best pollutants removal efficiency were fixed from 780°C to 820°C. The next picture shows the thermal oxidizer.





## 4.5 Control parameters

The VTU operation is monitored by a Programmable Logic Controller (PLC). The following key data is monitored:

- Vapor temperatures at all steps of the process
- Pile depression to ensure proper aspiration of the vapours
- Pressure points at all steps of the VTU
- Mercury content after the blower
- Gas emissions at the Thermal Oxidizer chimney (COV, CO, NO<sub>x</sub>, PM2.5, PM10, PCDD, HCl, HF, SO<sub>2</sub>)

## 6. Post treatment and/or Long Term Monitoring

### 6.1 Post treatment and/or Long Term Monitoring

Post treatment monitoring consists of soil samples analysis.

## 7. Additional information

### 7.1 Lesson learnt

Special care needs to be taken when operating in countries where below-zero temperatures can be reached. In the case of this project, glycol needed to be mixed with water in the cooling sections.

- It can be beneficial to perform more advanced analysis than the ones provided by the end customer. In particular, the presence of acidic compounds is not relevant per se to the remediation but can damage the equipment.



## 7.2 Additional information

The success of remediation is determined by the compliant pollutants content in the soil after treatment as well as compliant emissions throughout the treatment.

## Glossary of Terms

<b>Term (alphabetical order)</b>	<b>Definition</b>
VTU	Vapor Treatment Unit

## 1. Contact details - CASE STUDY: SVE n.3

<b>1.1 Name and Surname</b>	Luca Sacilotto
<b>1.2 Country/Jurisdiction</b>	Italy
<b>1.3 Organisation</b>	Ramboll Italy S.r.l.
<b>1.4 Position</b>	Senior Managing Consultant
<b>1.5 Duties</b>	Project management of contaminated sites and brownfield assessments for industries; development and implementation of complex remedial projects addressing a wide variety of contaminants in several hydrogeological settings.
<b>1.6 Email address</b>	<a href="mailto:lsacilotto@ramboll.com">lsacilotto@ramboll.com</a>
<b>1.7 Phone number</b>	+39-3341319233



## 2. Site background

### 2.1 History of the site

The site extends over a surface of around 90,000 m<sup>2</sup>, of which around 82,000 m<sup>2</sup> is paved or covered by buildings (buildings cover an area around 41,000 m<sup>2</sup>).

The plant began the production of freezers and refrigerators for food preservation in 1967, production which is still ongoing even if at a reduced rate. The contamination of the site was discovered in 2009 during site characterization activities, and exceedances of the CSC have been identified in deep soils (depth > 1 m bgl) for organochlorinated compounds (vinyl chloride, 1,2-Dichloroethane, Trichloroethylene, 1,2-Dichloropropane), and in groundwater for the following compounds:

- Non-Volatile Metals: Iron, Manganese;
- inorganic compounds: Nitrite, Sulphate;
- BTEX: Toluene, Benzene;
- chlorinated aliphatic compounds: Tetrachlorethylene, Trichloroethylene, Vinyl Chloride, Chloroform, 1,2-Dichloroethane, 1,1-Dichloroethylene, 1,2-Dichloroethylene, 1,2-Dichloropropane, 1,1,2-Trichloroethane.

Furthermore, local areas of buried wastes were found at the site, and removed during subsequent intervention, but it cannot be excluded that additional buried wastes are still present.

## 2.2 Geological setting

Only the shallow portion of soil and groundwater, till a depth of about 15 m b.g.l., was investigated during the site characterization. The subsoil is formed by alluvial deposit formed by interbedded sandy and silty layers as indicated below, overlaying a silty aquitard (see figure below). At a regional scale, a thin semiconfined aquifer contained in a conglomerates formation is present at 70 m b.g.l.

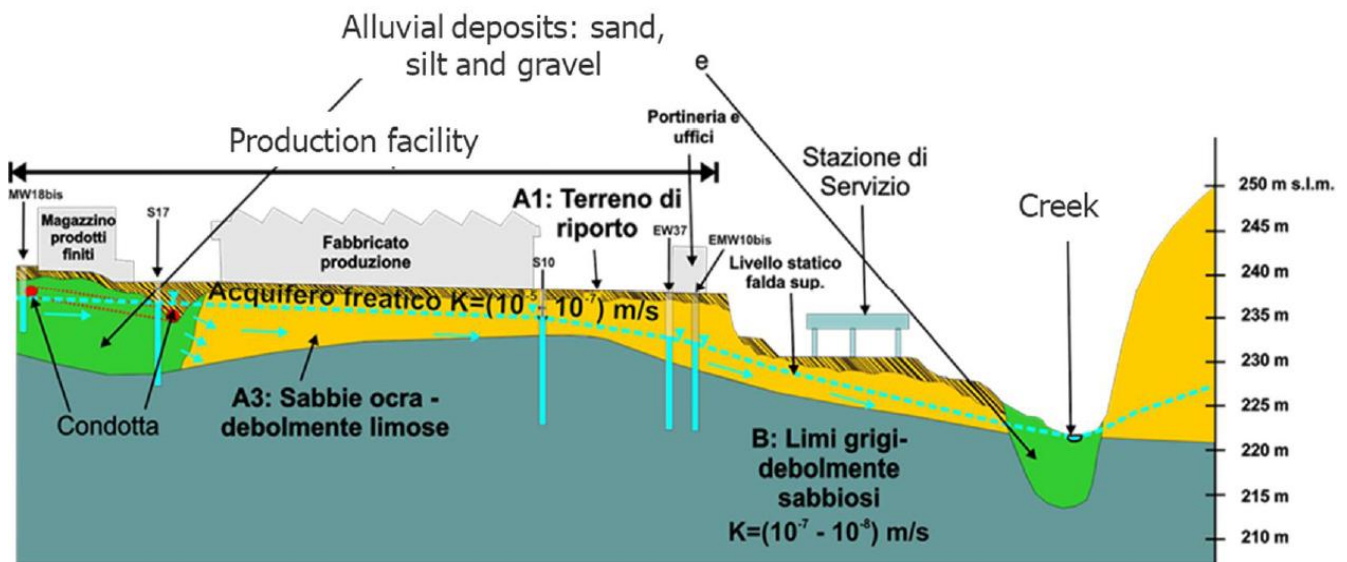

The figure represents the hydro-geological cross-section of the site along the groundwater flow main direction (North-East to South-West).

During site characterization, shallow groundwater levels were ranging between 2 and 9 m b.g.l. (on average 4 m b.g.l.), with flow direction mainly from the upgradient hill (North, North-West) to South, South-Est, towards a Creek; however, groundwater flow at the N-E corner of the facility is affected by the presence of an intubated stream existing at the northern portion of the facility with direction from N-E to S-W, generating a local depression of the groundwater table. Backfilling materials used in the past in earth moving activities for underground installation of the intubated stream appear to be characterized by a low permeability, even if presence of more permeable alluvial materials (sand and gravel) is documented along the pipe at depths between around 8 and 11 m b.g.l. Average groundwater gradient was estimated equal to 3% and hydraulic conductivity ( $k$ ) ranges between  $10^{-6}$  (North-West side) and  $10^{-8}$  m/s (North-Est side), with an average value of  $5 \times 10^{-7}$  m/s.



## 2.3 Contaminants of concern

### Soil:

- vinyl chloride: 0.42 ÷ 0.45 mg/kg
- 1,2-Dichloroethane: 7 ÷ 672 mg/kg
- Trichloroethylene: 20 ÷ 43 mg/kg
- 1,2-Dichloropropane: 27 ÷ 154 mg/kg

### Groundwater:

#### Non-Volatile Metals:

- Iron: 3.1 ÷ 41,400 µg/l
- Manganese: 0.89 ÷ 18,500 µg/l

#### BTEX:

- Toluene: 0.05 ÷ 200 µg/l
- Benzene: 0.053 ÷ 56 µg/l

#### Chlorinated aliphatic compounds:

- Tetrachlorethylene: 0.05 ÷ 38 µg/l
- Trichloroethylene: 0.05 ÷ 31,000 µg/l
- Vinyl Chloride: 0.031 ÷ 410 µg/l
- Chloroform: 0.018 ÷ 69 µg/l
- 1,2-Dichloroethane: 0.018 ÷ 4,800,000 µg/l
- 1,2-Dichloroethylene: 0.054 ÷ 22,000 µg/l
- 1,2-Dichloropropane: : 0.019 ÷ 89,000 µg/l



## 2.4 Regulatory framework

Clean-up goals for soil and groundwater were defined in the Risk Assessment, and are included in the on-going remedial plan, approved in 2012 (the updated approval in 2017 did not modify them).

According to Italian regulation, although the remedial targets are defined on a Risk Assessment basis inside the facility (SSTLs or CSR), groundwater quality at the end of remedial action must comply with regulatory limits (CSC, much more conservative than calculated SSTLs) at the downgradient boundary of the site. Therefore, once reduced the concentration below the CSR for inhalation risk inside the facility, the ultimate clean-up goal for groundwater is to reduce and control the off-site migration at the Southern and Eastern borders of the site. In particular, a general conformity of the Southern border of the site is registered, with an exception at one piezometer at the south-eastern site boundary, where concentrations for TCE are slightly over the potable limit ( $10 \mu\text{g/L}$ ) and one order of magnitude above the regulatory limit (CSC =  $1.5 \mu\text{g/L}$ ). Along the Eastern border, one piezometer exceeds regulatory limits both for 1,2-DCA and 1,2-DCP, with a contamination 2-3 orders of magnitude above the respective regulatory limits (CSC for 1,2-DCA =  $3 \mu\text{g/L}$ ; CSC for 1,2-DCP =  $0.15 \mu\text{g/L}$ ).



### 3. Pilot-scale application in field

No pilot test was performed

### 4. Full-scale application

#### 4.1 Extraction system

The SVE system is composed of two extraction wells and an horizontal trench, and it is combined with an Air Sparging (AS) system which includes four wells. The characteristics of the installed systems are as follows:

- N.2 SVE wells (namely SVE1 and EMW30 both 7 meters deep, with a screened interval from 3 to 7 m bgl. SVE1 is 4" diameter, and EMW30 3");
- N.1 horizontal trench (100 meters long, with a diameter of 200 mm);
- N. 4 AS wells (one close to the trench and EMW30, namely AS1p, and three close to SVE1, namely AS14, AS15, AS16). AS wells are 15 meters deep, and with a 2" diameter. They are all screened in the interval 14-15 m bgl;
- the SVE system is powered by a blower "MAPRO 36/21" (5.5 kW, 220V, triphase 50 Hz);
- the AS system is powered by a scroll compressor "Atlas Copco SF2" (2.2 kW, 220V, triphase, 50 Hz).

#### 4.2 Injection system

As previously mentioned, four injection wells are installed to circulate air in groundwater (Air Sparging) with the scope to strip contaminants that would then be collected by the SVE system. Air is injected at an average pressure of 1 bar.

#### 4.3 Radius of influence

The theoretical value of ROI, calculated in the design phase for the Air Sparging was estimated as 5 to 10 meters.



## 4.4 Off gas Treatment

As for off-gas treatment, there are two granular activated carbon (GAC) filters (1 cubic meter each) in series connection.

## 4.5 Control parameters

- Air flow and extraction rates
- Air pressure measurements
- Water levels
- Dissolved oxygen and contaminant concentrations in groundwater
- Oxygen, carbon dioxide and contaminant concentrations in SVE off-gas or soil vapour
- Mass removal

# 7. Additional information

## 7.1 Lesson learnt

- Low permeability soils difficult to treat through AS technology.
- The presence of heterogeneous subsoil is a big challenge for this types of in-situ technologies.



## 7.2 Additional information

To assess the success of remediation is fundamental to perform:

- trend analysis of each contaminant monitored over time with respect to the initial baseline value
- quantification of extracted mass over time

## 7.3 Training need

To ensure the achievement of remediation goals is fundamental to perform a good operation and maintenance of the overall system. To do that is important that the system is managed by trained personnel. Despite a general training can be done from webinars and e-learning to obtain a targeted training specific for the single system installed few on-the job session, especially in the first weeks of system running, can be a good way to have site personnel sufficiently trained with respect to the specific performances of the system installed.

## Glossary of Terms

A glossary will help a you to maintain the level of precision necessary for key terms and maintain consistency across the text. We found out that sometimes terms that sounds similar like “contaminated” and “polluted” are used in the same way as synonyms in some country, while in other they have different meanings (due to legislation or for other reasons). So fill in this glossary for your key elements and of course for acronyms.

<b>Term (alphabetical order)</b>	<b>Definition</b>
SSTLs or CSR	Site Specific Target Level, which are named CSR in Italian regulation, are concentration target levels defined according to Risk Analysis procedure

## 1. Contact details - CASE STUDY: SVE n.4

<b>1.1 Name and Surname</b>	Luca Sacilotto
<b>1.2 Country/Jurisdiction</b>	Italy
<b>1.3 Organisation</b>	Ramboll Italy S.r.l.
<b>1.4 Position</b>	Senior Managing Consultant
<b>1.5 Duties</b>	Project management of contaminated sites and brownfield assessments for industries; development and implementation of complex remedial projects addressing a wide variety of contaminants in several hydrogeological settings.
<b>1.6 Email address</b>	<a href="mailto:lsacilotto@ramboll.com">lsacilotto@ramboll.com</a>
<b>1.7 Phone number</b>	+39-3341319233

## 2. Site background

### 2.1 History of the site

Since its first installation (1970), within the site have been produced compressors for refrigerators and air conditioning units. The analysis of the production processes within the facility highlighted the use in the past of potentially polluting substances such as heavy metals and chlorinated solvents, mainly PCE, TCE and Cr IV. The production was active up to 2018 and then the assembly lines have been dismantled.

### 2.2 Geological setting

Site soil consists largely of silts and clays interbedded with thicker layers of fine sands. This succession mainly consists of silty-clayey layers with two major sandy layers of different thickness, ranging from few centimetres to about 1 meter, located in the following ranges of depth:

- Level 1: between 10 and 15m b.g.s.
- Level 2: between 25 and 30m b.g.s.

The depth to ground water is approximately 5-7 meters below ground surface.

The following image depict the geological setting of the first two meters of soil subjected to ventilation through the SVE system.





## 2.3 Contaminants of concern

The main compounds of concern are:

- tetrachlorethylene (PCE),
- trichloroethylene (TCE),
- cis 1,2-dichloroethylene (cis 1,2-DCE),
- trans 1,2-dichloroethylene (trans 1,2-DCE),
- 1,1-dichloroethylene,
- chloroform,
- vinyl chloride (VC),
- freon-11,
- freon-113

## 2.4 Regulatory framework

The administrative path of the remediation process started on 2001 when the client informed the Public Authorities of a potential contamination resulting from the presence of chlorinated solvents in groundwater detected during a series of investigations carried out in order to verify the quality of the subsoil at the Site. Subsequently, the following activities have been done: Site Characterization, Preliminary Remediation Design, Final Remediation Design for the treatment of the contamination from groundwater. In 2016 an ambient-air survey highlighted the absence of risks for workers to be exposed to contaminant chlorinated vapours stemming from the contaminated groundwater.

Nevertheless, the client, as a preventive and precautionary measure for workers decided to install a Soil Venting system (same technology of a classical SVE system) to brake any possible migration pathway of contaminated vapours from the groundwater to the productive building.





## 3. Pilot-scale application in field

### 3.1 Extraction system

Before the installation of the full scale system, a pilot scale application has been performed to estimate the effective radius of influence that potentially can be achieved from each extraction well. The test was carried out connecting, through flexible pipes, one vertical well of 4" diameter, 2 m depth screened from 0.5 m below ground level to 2 m depth, with a blower for vapour extraction (with filters and silencers). In addition, the system included a condensate separator to remove water from the extracted gas before to pass through the blower and a granular activated carbon unit (200 L) to treat the contaminated vapour streams before the emission in atmosphere. Moreover, the well head of the extraction well was equipped with a pressure gauge and connected to the extraction system through a flexible pipe. Along the extraction line (2" diameter) there was a manual adjustment valve, vacuum gauge, sampling points and two asameters for air flow measurement.



### 3.3 Radius of influence



Examples of vacuum measurements at wellhead (left) and monitoring point (right)

Two tests were performed to estimate the radius of influence: step test and long duration test.

For the step test increasing flow rates have been considered with values centred around the design value:

- 26 m<sup>3</sup>/h
- 40 m<sup>3</sup>/h (design value)
- 50 m<sup>3</sup>/h
- 80 m<sup>3</sup>/h
- 125 m<sup>3</sup>/h

During each step test, the following parameters were monitored:

- suction depression at the blower,
- depression on the wellhead of the suction point,
- depression induced on the soil gas monitoring points,
- flow rate of extracted gases,
- VOC concentrations.

On the basis of the step test outcomes a flow rate of 60 m<sup>3</sup>/h has been sustained



constant for about 48 hours during which the same parameters of the step tests have been monitored.

Plotting in semi-logarithmic graph the depressions induced in the monitoring points at different distances from the extraction well and considering a cut-off pressure of 1% of the depression measured at the wellhead (Johnson and Ettinger, 1994), namely 0.12 mbar, a ROI of about 120 m has been estimated from the suction shaft considered for pilot test.

### **3.4 Off gas Treatment**

During the pilot scale application in field, off gas were treated by a granular activated carbon unit of 200 L to treat the contaminated vapour streams before the emission in the atmosphere.

### **3.5 Control parameters**

To assess the effectiveness of the treatment the following parameters were monitored during the pilot scale application:

- suction depression at the blower,
- depression on the wellhead of the suction point,
- depression induced on the soil gas monitoring points at different distances from the extraction well,
- flow rate of extracted gases,
- VOC concentrations.

## 4. Full-scale application

### 4.1 Extraction system

The full scale SVE system basically consist of 5 extraction wells, 4 of which within the productive building and 1 in the external area still within the site boundary. Each vertical extraction well is of 4" diameter, 2 m depth screened from 0.5 m below ground level to 2 m depth. Each vacuum well is connected to the vacuum unit through HDPE underground and aboveground pipes of 2", 3" and 4" to take into account pressure drop along the line.

The vacuum unit is basically composed of 2 vacuum blowers (one as backup blower), air flow rate 230 Nm<sup>3</sup>/h each, with filters and silencers, 1 condensate separator to remove water from the extracted gas before to pass through the blower and 1 electrical panel to control the blowers. Outside the vacuum unit there are 2 granular activated carbon units (1 m<sup>3</sup> each with about 600 kg of carbons) and a chimney for treated gas emissions. Each well head is equipped with a pressure gauge and along each of the 5 extraction lines there are from the bottom to the top: sampling port, flow meter, pressure gauge, regulation valve, on/off valve.



Examples of instruments along each extraction line

The system is completed by 32 monitoring points spatially distributed to cover the overall treated area.

To assess the different performances for different monitoring system we installed:

- N. 9 “nesty probes”, 7 of which in external area and 2 within the facility;
- N. 23 “vapor pin” within the facility.



Nesty probe



Vapor Pin

## 4.3 Radius of influence

As a result of pilot test an extraction flow rate of about  $50 \text{ m}^3/\text{hour}$  for each of the 5 extraction wells has been set and a ROI of about 50 m has been associated with each extraction well in order to cover the planar extension of the groundwater plume which has basically an orientation north-south. The following image depict the expected ROI (brown dotted lines) from each extraction well (green squares).

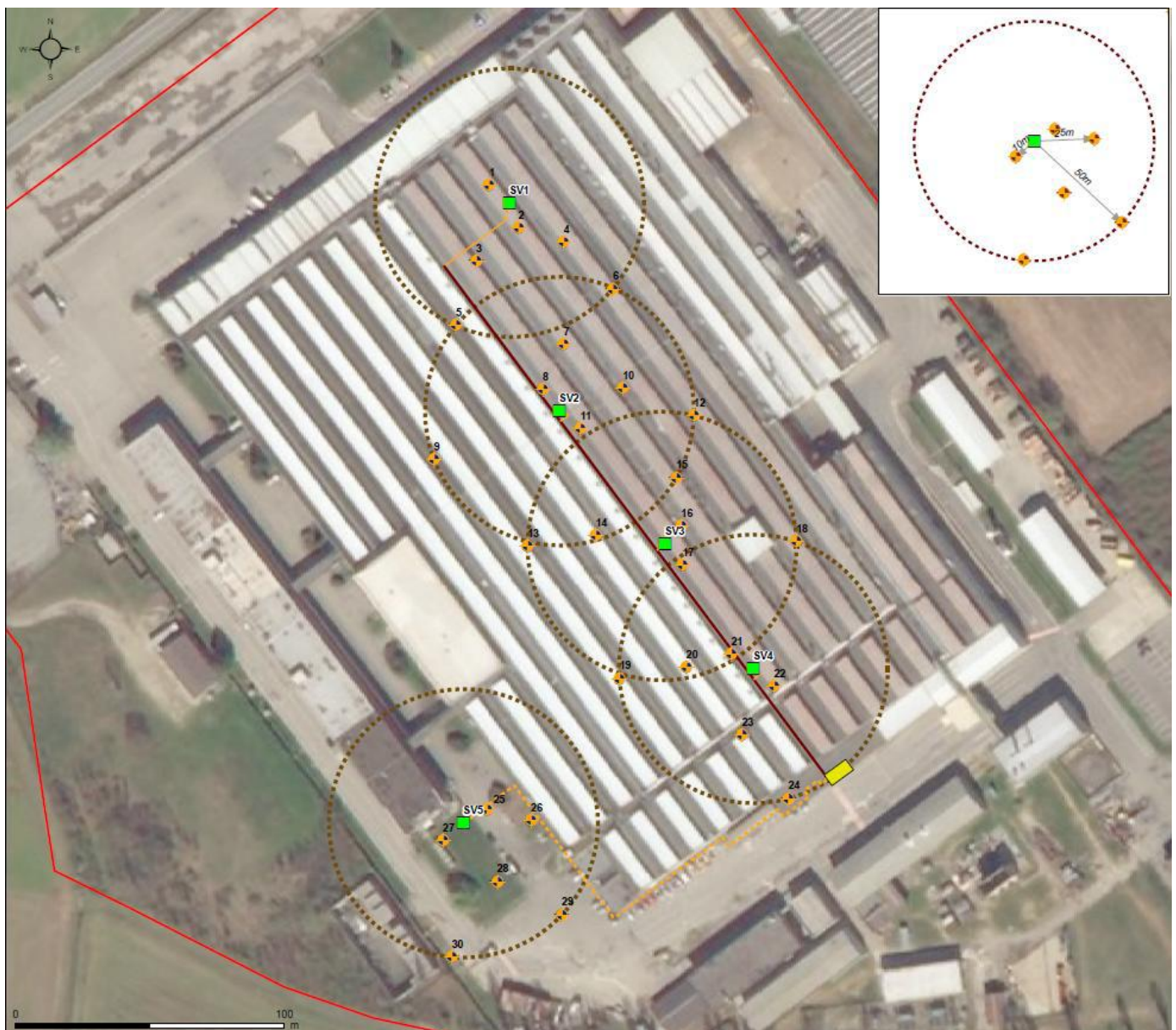

System layout with expected ROI

## 4.4 Off gas Treatment

Off gas treatment is basically composed of 2 granular activated carbon units (1 m<sup>3</sup> each with about 600 kg of granulated activated carbons) and a chimney for treated gas emissions in the atmosphere.







## 4.5 Control parameters

To assess the effectiveness of the treatment the following parameters were monitored with the following frequency

With a weekly basis:

- flow rate of each extraction well,
- temperature and pressure/ suction depression both upstream and downstream the blower,
- the occurrence of condensate waters,

With a 3 months basis:

- VOC, O<sub>2</sub>, CH<sub>4</sub>, CO<sub>2</sub> and depression induced at each monitoring point,
- soil gas concentration for each monitoring point, well heads and off gases before the emission in atmosphere

## 5. Enhancements to SVE

No pneumatic and/or hydraulic fracturing systems has been employed to enhance the SVE application which was designed only to ventilate and hence brake any possible pathways of contaminated streams from the groundwater to the productive building.

## 6. Post treatment and/or Long Term Monitoring

### 6.1 Post treatment and/or Long Term Monitoring

The treatment is still ongoing but as a long term monitoring plan it can be scheduled monitoring campaigns on a six months basis on each soil gas control point available at the site and an ambient-air monitoring survey on a year basis to verify if any changes with respect to the status achieved at the end of ventilation.



## 7. Additional information

### 7.1 Lesson learnt

#### 1) Methodology and procedures

Before the installation of a full scale system perform a pilot test to verify, with field data, the design hypothesis related to ROI extension and flow rate achievable from each extraction well since due to local heterogeneities not all wells perform at the same way.

#### 2) Technical aspects

Prior the installation of the extraction wells perform a detailed screening and review of historical maps of the areas that need to be treated with a sub slab ventilation to assess the occurrence of any subsurface services which can reduce the extension of expected ROI, hence reducing the overall efficacy of the system.

#### 3) Legislative, organizational aspects

To be compliant with regulation limits for off gas emission is key the periodic check of the efficacy of the treatment system to avoid the emission in atmosphere of contaminated gases.

### 7.2 Additional information

To assess the success of remediation is fundamental to perform:

- trend analysis of each contaminant monitored over time with respect to the initial baseline value
- quantification of extracted mass over time

### 7.3 Training need

To ensure the achievement of remediation goals is fundamental to perform a good operation and maintenance of the overall system. To do that is important that the system is managed by trained personnel. Despite a general training can be done from webinars and e-learning to obtain a targeted training specific for the single system installed few on-the job session, especially in the first weeks of system running, can be a good way to have site personnel sufficiently trained with respect to the specific performances of the system installed.

## 1. Contact details - CASE STUDY: SVE n.5

<b>1.1 Name and Surname</b>	Federico Caldera
<b>1.2 Country/Jurisdiction</b>	Italy
<b>1.3 Organisation</b>	Mares S.r.l.
<b>1.4 Position</b>	Analista Sviluppo & Compliance
<b>1.5 Duties</b>	Sanitary and environmental risk assessment, innovative remediation and characterization technologies development
<b>1.6 Email address</b>	<a href="mailto:federicocaldera@maresitalia.it">federicocaldera@maresitalia.it</a>
<b>1.7 Phone number</b>	+39 3497616386

## 2. Site background

### 2.1 History of the site

The site is a gas station in peripheral area south of a city of central Italy, along a road with medium vehicular traffic.





## 2.2 Geological setting

The geological structure of the area is characterized by the presence of soils of volcanic origin and deposits of alluvial origin.

In the area under examination the volcanic deposits of the Pleistocene age produced by the volcanic systems of Lazio emerge.

From a geomorphologic point of view, the site is located on the slope in a hilly area artificially terraced for the construction of the square.

Hydrography essentially consists of a series of ditches which, with dendritic branching, flow north-east. They have a torrential regime, with superficial outflows that occur during intense rainfall and of a certain duration, mainly in the winter season.

The area is characterized in general by soils with variable permeability, both in relation to the variety of soils constituting the stratigraphic succession, and to the frequent variability of the lithological and structural aspects found within the individual units that make up this succession.

The site stratigraphy is characterized by the presence of the following two main units:

- Anthropic material - Mixed material, essentially consisting of medium sand with the presence of gravel/pebbles, which extends from 0 m from ground level. about 3 m b.g.s.;
- Silt and Clays - Cohesive deposit made up of silts and clays with local intercalations of coarser sandy lenses, found up to the maximum investigated depth (10 m b.g.s.).

Literature data allow us to hypothesize the presence of a significant underground water circulation at high depths: in a well surveyed about 400 m south of the gas station area, a water table level of 78 m a.s.l. is reported, corresponding to a depth from the ground surface at the site of about 45-50 m.

## 2.3 Contaminants of concern

Contamination affected unsaturated soil, with BTEX, C<sub>≤12</sub> and C<sub>>12</sub> as CoCs, found at a depth of 3.4 m b.g.s.



## 2.4 Regulatory framework

In Italy the environmental regulatory system is regulated by Legislative Decree No. 152/2006 and for fuel stations by the Ministerial Decree No. 31/2015.

The target values for benzene, toluene, ethylbenzene, xylene, C<12 and C>12 are set equal to 50, 50, 50, 50, 250 and 750 mg/kg, respectively, for soils with commercial use. For the implementation of SVE technology (as well as for the implementation of any remediation plan) the approval by local authorities is needed.

## 3. Pilot-scale application in field

### 3.1 Extraction system

The execution of the pilot test, placing vertical wells SN03 and SN04 (5 meters depth, screened between 1 and 5 m b.g.s.) in depression by a blower, showed that:

- by varying the extraction rate (from 30 to 1000 L/min) within point SN03, rather small depressions were detected in the monitoring points, in any case lower than the value of 0.5 mbar (the maximum value was 0.3 mbar observed in SN04 with an extraction rate of 1000 L/min) indicated by literature as the minimum depression to have an induced influence from the well being extracted (“cut off” value);
- during the test a further test was performed by putting in depression point SN02: also in this case, depressions were observed within the point SN03 lower than the value of 0.5 mbar (the maximum value was 0.2 mbar observed in SN03 with an extraction rate of 2330 L/min);
- no condensation accumulation was detected during the test inside the separator.

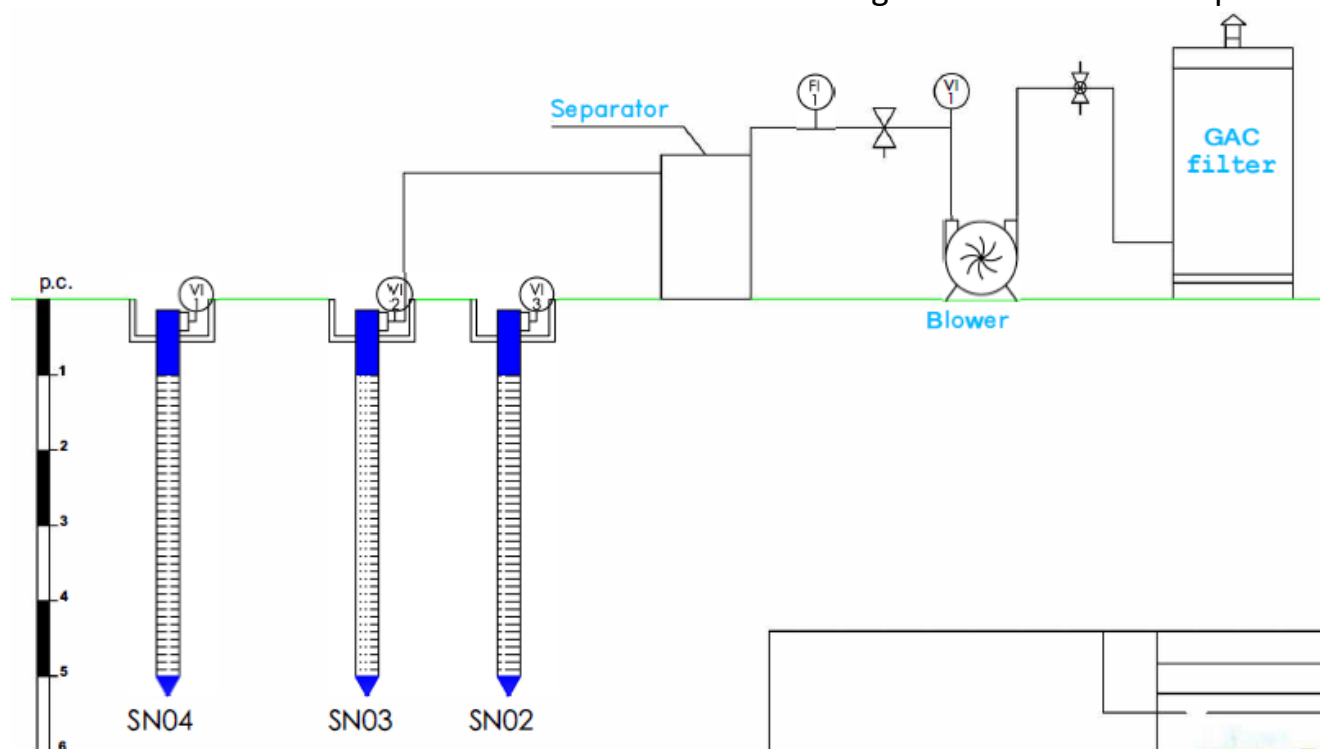

The results obtained by means of the pilot study performed allowed to confirm the applicability of the SVE system to the site. The high permeability of the subsoil to vapor flows, in fact, made it possible to extract significant quantities of air without inducing significant depressions.



### 3.3 Radius of influence

The project parameters, obtained on the basis of the pilot study specifically performed on the site, are the following:

- Radius of influence, ROI: 3.0 m;
- Maximum flow rate of extracted air for each SVE point, Q<sub>Ea</sub>: 70 m<sup>3</sup>/h;
- Working depression at each point, d<sub>Pp</sub>: - 50 mbar.

### 3.4 Off gas Treatment

For the abatement of pollutants present in the extracted air was set, downstream of the air/liquid separation system, a pair of iron with epoxy treatment filters, filled with activated carbon in pellets, (H 1400 mm x D 780 mm).

### 3.5 Control parameters

During the test, the data listed below were recorded:

- extraction rate;
- d<sub>Pp</sub> work-related depression and d<sub>Pi</sub>-induced depression;
- VOC, CH<sub>4</sub>, CO<sub>2</sub> and O<sub>2</sub> in the extraction well.



## 4. Full-scale application

### 4.1 Extraction system

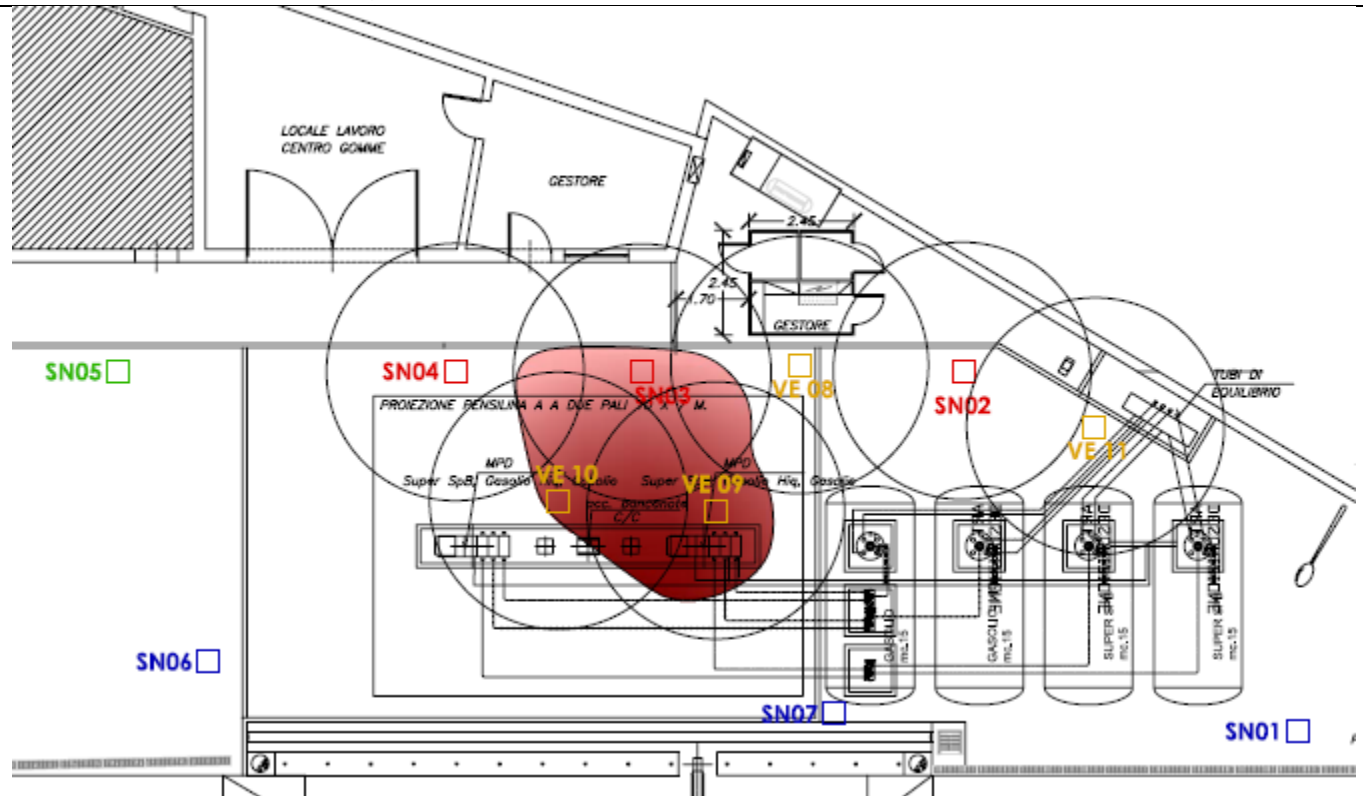

A blower is used to extract air from the remediation points; the extracted air favours the removal of contaminants from the solid phase to the gas phase. The air extracted from the same points is conveyed inside a condensate separator (S1) which separates the condensate from the gaseous flow.

The gaseous flow, once dehumidified and the particulate removed, passes through the blower which generates the vacuum. Downstream there is the air handling unit consisting of two filters in series, containing activated carbon. In any case, the processing unit is equipped to be arranged with the filters in parallel in case the incoming flow shows compatible VOC concentrations.

In order to maximize the treatment of the unsaturated soil and to reduce the moisture content of the extracted air, the plant is also provided with an evacuation, treatment and discharge system for the percolating waters that accumulate preferentially in the SN02 and SN03 piezometers.

Two additional extraction points located outside the contaminated area were installed, with the aim of enhancing the recall of vapours from the subsoil to further safeguard the human targets located in the building next to the gas station.

The number of SVE points is therefore equal to 7. Specifically, the existing piezometers SN02, SN03 and SN04 and the new points VE08, VE09, VE10 and VE11 were used, see the picture below.

The suction from the points was operated by a pump capable of reach a vacuum of at least 150 mbar, and a flow rate of not less than 500 m<sup>3</sup>/h, in order to guarantee an air flow, for each extraction point, of at least 70 m<sup>3</sup>/h, with a nominal power of about 5.50 kW.

### 4.3 Radius of influence

Considering the ROI determined through the pilot test and the areal distribution of the contamination, the number of extraction wells and their spatial location were defined. A correct ROI value of 3 m was therefore adopted as a precaution.

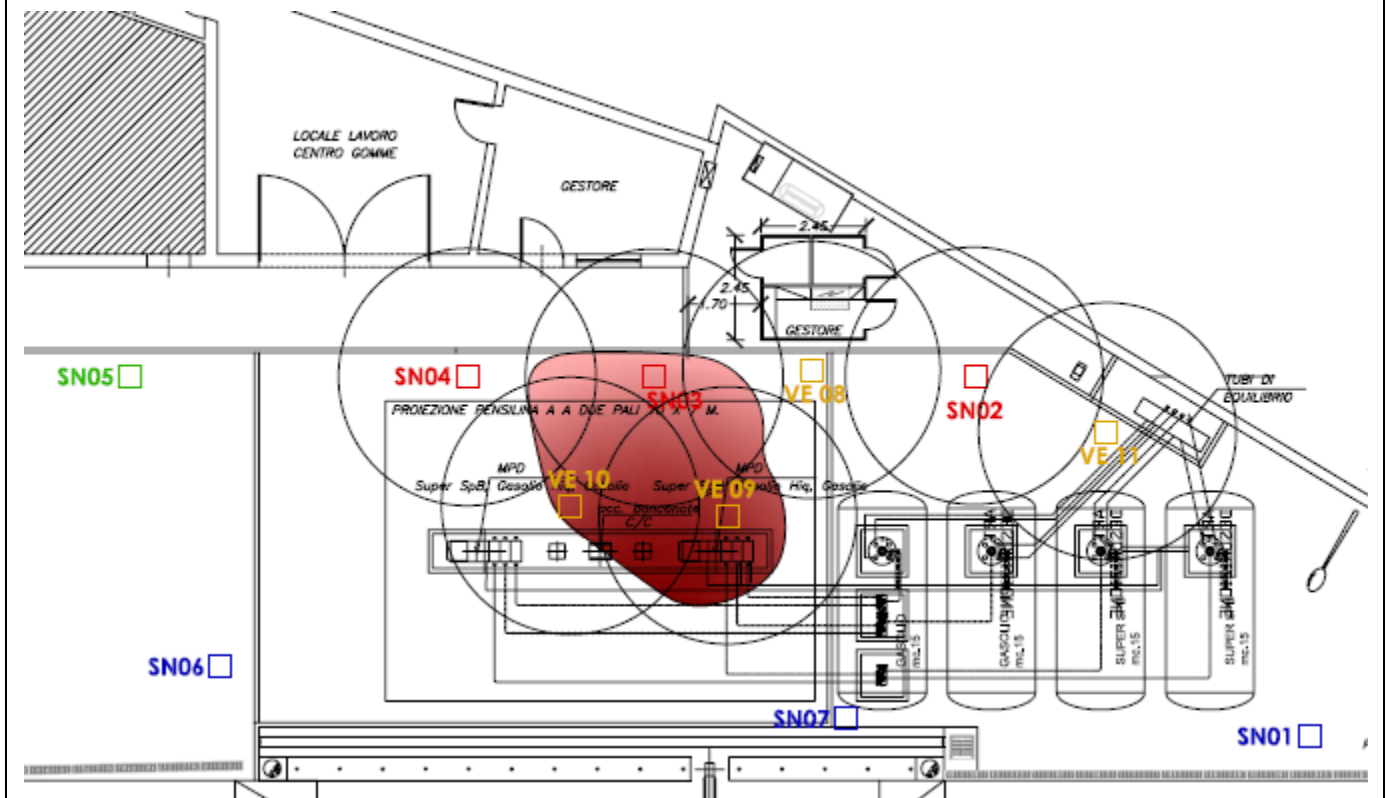

### 4.4 Off gas Treatment

Same of pilot test



## 4.5 Control parameters

Before starting the system, at Time Zero, a complete monitoring was carried out. In particular, the following activities were carried out on all the extraction wells present on site (VE02, VE03, VE04, VE08, VE09, VE10 and VE11):

- measurement of the VOCs present in the extraction points;
- sampling of off air and analysis of parameters such as BTEX and TPH.

During the start up of the system, the following measurements were carried out on a weekly basis:

- measurement of the VOCs extracted from the points and leaving the stack (ppm);
- vacuum induced by the blower (mbar) in the extraction points;
- flows at each extraction point;
- depression induced on the water inside the extraction points.

The start up took about 30 working days and ended with the testing of the air and water treatment system by sampling and laboratory analysis of the vapours entering and leaving the system.

Then, on a monthly basis, control visits were carried out on the plant in order to verify the correct functioning of the system and monitor the operating parameters of the plant (measurement of VOCs, induced depressions, extracted air flows, extracted water flows) making any new adjustments if necessary.

## 6. Post treatment and/or Long Term Monitoring

### 6.1 Post treatment and/or Long Term Monitoring

The periodic monitoring of the SVE system (between 2018 and 2020) provided for:

- control, maintenance and monthly monitoring of the systems and verification of the correct functioning of the system;
- verification and reading of the operating parameters of the system (flows, temperatures, pressures, etc.);
- possible fine-tuning, in the case of variations detected with respect to the operating parameters;
- sampling of air inlet and outlet from the treatment system and analysis of the BTEX and TPH parameters.



## 7. Additional information

### 7.1 Lesson learnt

In presence of a VOC contamination located in a small part of unsaturated soil with a coarse texture the SVE technology can be a viable system to reach the remediation goals.

The intervention was successful - Authorities certification obtained after two years of remediation.

### 7.2 Additional information

The keystone issue for a successful remediation is to gain a right conceptual site model, with a proper definition, in terms of extent, soil texture and presence of preferential flow pathways of the underground contamination source, in order to find adequate technology to properly address and remediate the CoCs.

### 7.3 Training need

Firstly e-learning/webinars in order to understand the theoretical fundamentals of the technology, following training on the job so to gain experience with facing real problems.

## Glossary of Terms

Term (alphabetical order)	Definition
BTEX	Benzene, Toluene, Ethylbenzene, Xylene
C $\leq$ 12	Light hydrocarbons
C $>$ 12	Heavy hydrocarbons
VOC	Volatile organic compounds (VOCs) are organic chemicals that have a high vapour pressure at ordinary room temperature

## 1. Contact details - CASE STUDY: SVE n.6

<b>1.1 Name and Surname</b>	Davide Menozzi, René Filion, Sophia Dore
<b>1.2 Country/Jurisdiction</b>	United States of America
<b>1.3 Organisation</b>	GHD Group Pty Ltd
<b>1.4 Position</b>	Environmental scientist (Davide Menozzi) Senior Project Manager (René Filion) Senior Scientist Innovative Technology Group (Sophia Dore)
<b>1.5 Duties</b>	Contaminated land management
<b>1.6 Email address</b>	<a href="mailto:Davide.menozzi@ghd.com">Davide.menozzi@ghd.com</a>
<b>1.7 Phone number</b>	+61 2 4222 2316 (Davide Menozzi) 01 514 339 0611(René Filion); 716 205 1978 (Sophia Dore)

## 2. Site background

### 2.1 History of the site

Approximately 23,000 kg of acetone was released from a rail car during unloading in July 2016 at a facility that stores, repackages, and distributes chemical products to wholesalers and industrial users.

The Property is irregular in shape, covers an approximate area of 125,000 square meters (m<sup>2</sup>) and is located in a industrial area, with a neighbouring residential area located to the south. This residential neighbourhood is located within 35 meters (m) from the Property limit at its closest proximity. A series of railway sidings are present at and in the western portion of the Site.





## 2.2 Geological setting

The Site stratigraphy in the area of the spill consisted of very shallow fill material extending to 0.6 m below ground surface (mBGS), followed by a layer of natural deposits silt with traces of clay or clay with traces of silt to approximately to approximately 4.5 mBGS. A layer of coarse material composed of sand and gravel measuring approximately 0.3 m thick rests on a grey fractured limestone with fair to excellent rock quality (RQD >95).

Native soils were composed of an initial deposit of silty clay, becoming at around 3 m below ground surface, a deposit composed of more sandy material, either being described as silt with some sand and traces of gravel, or as sand with some silt and gravel.

During intrusive investigations, odours were strongest near the surface (0.6 m to 1.2 m deep) and again near the bottom (4.3 m to 4.9 m deep).

## 2.3 Contaminants of concern

Acetone (primary)

Secondary contaminants:

Ethylbenzene

Toluene

Xylene

## 2.4 Regulatory framework

Following implementation of a Pilot Scale test at the Site that demonstrated effective operating conditions for SVE, a remedial objective of 28 mg/kg was established for acetone in soil, based on similar land use regulatory standards. For the secondary contaminants, existing standards for industrial/commercial land use were selected as remedial objectives ( Ethylbenzene = 50 mg/kg, Toluene = 30 mg/kg, Xylene=50 mg/kg).



## 3. Pilot-scale application in field

### 3.1 Extraction system

One shallow vertical extraction well screened to impart vacuum within the impermeable (shallow) layer of soil were installed throughout the treatment area. The effective radius of influence for these wells was approximately 3 metres. The shallow wells were equipped with 4-inch diameter PVC screens and risers, and terminated near the surface. Two existing 2-inch diameter vertical wells were used to extract vapours from the more permeable and deeper sand and gravel layer as the screened intervals for these wells intercepted the more permeable layer and extended to the top of bedrock/soil interface. The effective radius of influence measured during pilot testing for these wells was approximately 20 m.

A self contained mobile SVE equipment trailer was mobilized to the treatment area. The equipment included a high vacuum, high flow vacuum blower capable of producing up to 100 cubic feet per minute, and a vacuum of 10 inches of mercury, distribution header moisture separator, piping, valves and gauges, barometer, and vacuum gauges. The system was equipped with remote monitoring to the system control panel which could be programmed to run several configurations and on with definable operating timeframes.

### 3.2 Injection system

No injection of air or other substances were permitted.





## 3.3 Radius of influence

### Radius of Influence

The radius of influence (ROI) for each pilot test is estimated based on the vacuum response measured at the SVE monitoring probes and nearby wells, as well as past experience gained from operating SVE systems in similar soils. A probe response of 0.5 to 1.0 percent of the applied SVE wellhead vacuum is generally considered significant in ROI estimation. Due to the soil heterogeneity at the site and surface conditions, a wide range of vacuum response was observed. While vacuum response was achieved in the distant monitoring wells, response at the probes installed in the tighter material was inconsistent and likely masked by fluctuations in ambient barometric pressure.

### Upper Zone

As expected, the soil heterogeneity limited flow and vacuum response in certain directions due to pockets of tight native clays and silts that exist in the subsurface. In the upper zone, the monitoring probes showed a better response to the north compared to the south of SVE-01. The northern portion of the Site showed that an ROI of 3-4 meters would be achievable. The southern portion of the Site showed an ROI of less than 2 meters. ROI estimates showed very similar results when operated between 4 and 10" Hg vacuum. In this zone, the readings indicated that applying a less powerful vacuum may be more beneficial to achieving the best ROI as the 4" Hg vacuum showed the highest induced vacuum readings. The data also suggests that a period of hot, dry weather may have caused desiccation of shallow soils and well seals and resulted in short circuiting of ambient air from the surface. Hydration of surface soils in the pilot test area was successful in reducing the short-circuiting effects.

### Lower Zone

The lower, more permeable zone showed a more significant ROI compared to the Upper Zone. Based on the readings taken, operating at 6" Hg vacuum would provide the greater ROI with distances exceeding 20 meters. Of note, operating at higher vacuums dropped the ROI significantly, to a distance of only 6-8 meters. The extended ROI observed in the lower zone test is likely due to the higher permeability lenses and gravel observed at the top of bedrock in soil borings within the impacted area.

### Air Flow Rate versus Vacuum

Initially, for each step test, the unit was operated for short durations at various flow



rates and corresponding vacuum levels for the purpose of determining the SVE performance over the operating range of the blower and selecting the appropriate flow rate for the test (based on SVE flow rate and wellhead vacuum levels). Flow rate versus vacuum curves were constructed from these step test data to assist in the selection of the most desirable operating range for a full-scale system. An example of the results is shown in the figure below.

### Upper Zone

The step test showed a desirable operating range between 25-40 CFM with an applied vacuum of 4-6" Hg.

### Lower Zone

The step test at PO-101 (see Figure below) displayed good performance without a drop off up to a flow of 40 CFM with an applied vacuum of 8" Hg

AIR FLOW RATE VERSUS VACUUM

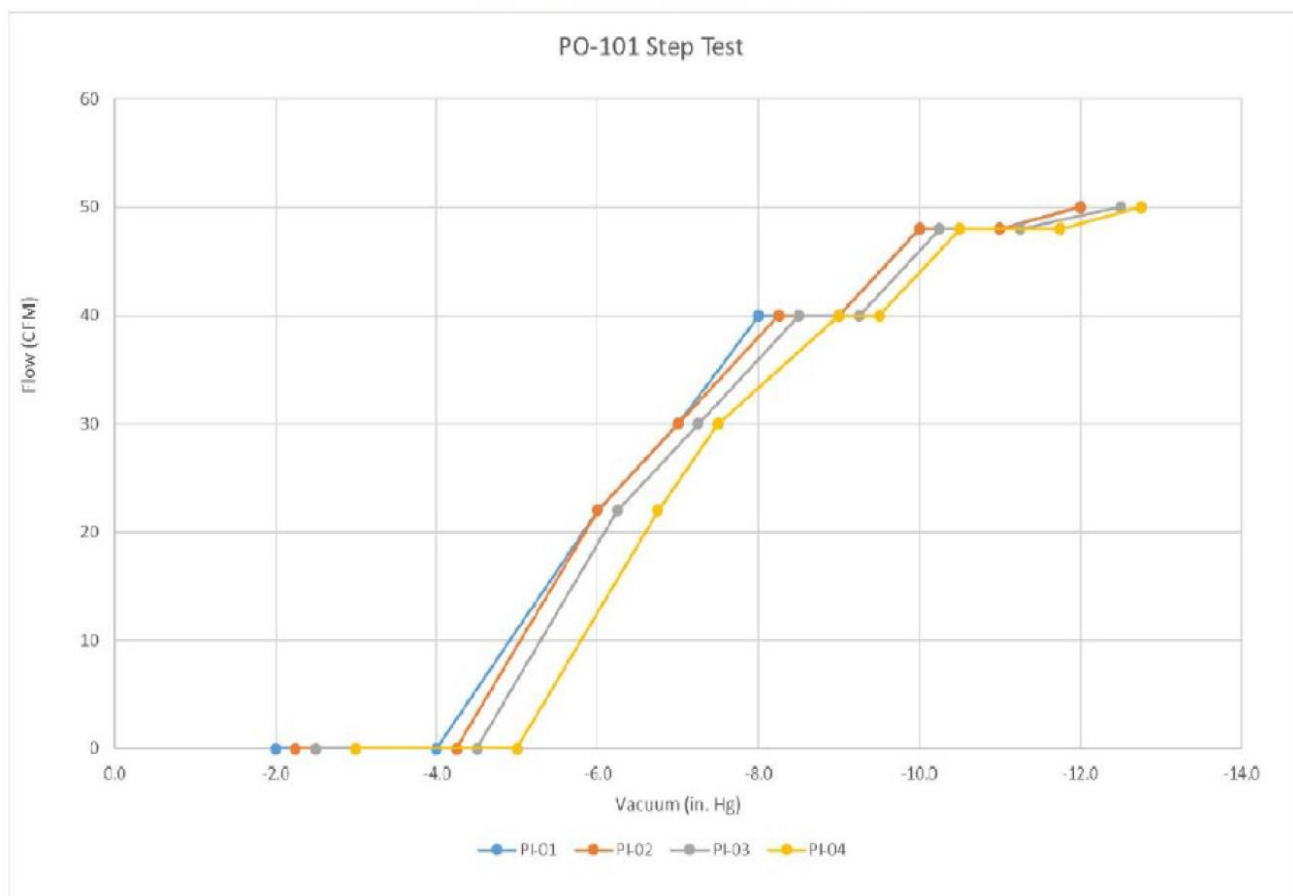



### **3.4 Off gas Treatment**

Extracted vapour treatment was completed using a 205 L drum of activated carbon during the short duration pilot testing period. No samples were collected of the air emissions during the pilot test.

### **3.5 Control parameters**

Soil analytical results were collected prior to and following each treatment phase to evaluate compliance with remedial objectives. These results were also used to configure the following phase of treatment (progressive reduction of treatment area). Groundwater samples were collected and submitted for analysis of volatile organic compounds (VOCs) within and downgradient of the treatment area to monitor for potential releases to groundwater from treatment activities.



## 4. Full-scale application

### 4.1 Extraction system

A total of 8 shallow vertical extraction wells screened to impart vacuum within the impermeable (shallow) layer of soil were installed throughout the treatment area. The effective radius of influence for these wells was approximately 3 m. The shallow wells were equipped with 4-inch diameter PVC screens and risers and terminated near the surface.

Five 2-inch diameter wells were used to extract vapours from the more permeable and deeper sand and gravel layer as the screened intervals for these wells intercepted the more permeable layer and extended to the top of bedrock/soil interface. The effective radius of influence measured during pilot testing for these wells was approximately 20 m.

A self contained mobile SVE equipment trailer was mobilized to the treatment area. The equipment included a high vacuum, high flow vacuum blower capable of producing up to 100 cubic feet per minute, and a vacuum of 10 inches of mercury, distribution header moisture separator, piping, valves and gauges, barometer, and vacuum gauges. The system was equipped with remote monitoring to the system control panel which could be programmed to run several configurations and on with definable operating timeframes.

### 4.3 Radius of influence

Based on the collected field data, the radius of influence of the deeper extraction wells measured was between 9.7 and 18 m, while the radius of influence of the SVE wells was between 5.1 m and 9.9 m.



## 4.4 Off gas Treatment

Discharge vapour monitoring of the system was performed in between and after the two 1,800-pound vapour phase carbon treatment vessels weekly by GHD using a photo ionization detector (PID) for measurement of undifferentiated VOCs.

### Air Sampling

In addition to the field PID readings collected above, air samples were collected at the sample port located between the two vapour phase carbon treatment vessels to monitor their performance to ensure that air emissions were below the regulatory limits.

Additional air samples were collected over the course of the SVE treatment in the extracted vapour flow before being treated to evaluate the extracted acetone mass through the vapour stream.

### Compliance

PID measurements in between and after the two vapour phase carbon treatment vessels showed readings of 0 ppm throughout the active SVE treatment period.

A dispersion model using SCREEN3 software was completed to assess compliance of air emissions equivalent to 2.5% of the regulatory limit for a 4-min exposure and 1.3% of the regulatory limit for a 1-hour exposure. Analytical results of samples collected throughout the treatment period identified concentrations of acetone reached approximately 1.1% of the permissible exposure rates.

Based on the PID measurements and analytical results from the air samples, air emissions did not present any exceedance of the applicable regulation during the operations of the SVE system.



## **4.5 Control parameters**

Soil analytical results were collected prior to and following each treatment phase to evaluate compliance with remedial objectives. These results were also used to configure the following phase of treatment (progressive reduction of treatment area).

Groundwater samples were collected and submitted for analysis of VOCs within and downgradient of the treatment area to monitor for potential releases to groundwater from treatment activities.

## **6. Post treatment and/or Long Term Monitoring**

### **6.1 Post treatment and/or Long Term Monitoring**

Post treatment groundwater monitoring will be completed three times per year for a minimum of 3 years to evaluate potential impacts to groundwater.

## **7. Additional information**

### **7.1 Lesson learnt**

SVE was an effective method for remediation of highly volatile contaminants at this Site. The addition of an impermeable ground cover layer effectively controlled short circuiting in the area of highest concentrations immediately adjacent to the spill area.

### **7.2 Additional information**

Success of remediation will be assessed in the post-remediation monitoring program.



## 7.3 Training need

Designing a remediation system requires experience. This cannot be easily built up through workshops, webinars and so on. Designing and implementation of a successful remedial system should be undertaken by an experienced company and scientists.

## Glossary of Terms

A glossary will help a you to maintain the level of precision necessary for key terms and maintain consistency across the text. We found out that sometimes terms that sounds similar like “contaminated” and “polluted” are used in the same way as synonyms in some country, while in other they have different meanings (due to legislation or for other reasons). So fill in this glossary for your key elements and of course for acronyms.

<b>Term (alphabetical order)</b>	<b>Definition</b>
VOC	Volatile organic compounds (VOCs) are organic chemicals that have a high vapour pressure at ordinary room temperature
CFM	Cubic feet per minute

## 1. Contact details - CASE STUDY: SVE n.7

<b>1.1 Name and Surname</b>	Hadas Sharon
<b>1.2 Country/Jurisdiction</b>	Israel
<b>1.3 Organisation</b>	Ludan environmental technologies
<b>1.4 Position</b>	Environmental engineer
<b>1.5 Duties</b>	Project manager
<b>1.6 Email address</b>	<a href="mailto:hsharon@ludan.co.il">hsharon@ludan.co.il</a>
<b>1.7 Phone number</b>	+972 52-511-2139





## 2. Site background

### 2.1 History of the site

A gas station operated at the site located in Israel for many years. As part of the change in the designation of the land, from a gas station for a commercial activity area, soil sampling was carried out in the area where underground fuel tanks were located, in order to make sure that the soil was not contaminated.

### 2.2 Geological setting

The following is a description of the geological section in the area:  
0-10 meters - loess and limestone.  
10-300 meters - cardboard, gray mahogany cardboard.

### 2.3 Contaminants of concern

The following are the various contaminants that are suspected in the soil due to the type of activity carried out at the site. These are pollutants that originate from fuel components:

- TPH
- BTEX
- MTBE
- PAH



## 2.4 Regulatory framework

- The subject of soil contamination investigation is the responsibility of a government ministry - the Ministry of Environmental Protection - Department of contaminated soils.
- The soil investigation performed according to the professional guidelines of the Ministry of Environmental Protection, which approves the sampling plan before execution and the conclusions and recommendations given according to the sampling findings.
- The concentrations of the pollutants discovered were compared to the permitted concentrations according to the threshold values document for industrial areas in the State of Israel.

## 3. Pilot-scale application in field

### 3.1 Extraction system

- The system in the ground includes 17 Vertical wells
- The pumping was done using a vacuum truck.

### 3.2 Injection system

- Details of the SVE pilot system infrastructure:
- The system in the ground includes 17 wells with a diameter of 3 inches, to three different depths: 7, 11 and 16 m below the ground.
- The large number of wells and the varying depths allows to "capture" of all the contaminated soil area.
- Each well is constructed so that at its bottom is a fluted section (strainer) 5 m long.
- The pumping was done using a vacuum truck, which was connected to well manifold, so that at each stage the effect of using a single well or several wells simultaneously could be examined by using the SVE system regulating taps.
- The system also included a clean air inlet tap to prevent the creation of underpressure in the pumping wells.



### 3.3 Radius of influence

- The radius of impact was determined by performing pumping until the pressure stabilized, measuring the underpressure in the well being pumped with varying flow rates and measuring the underpressure in the other wells to examine the radius of impact.
- The soil at the site was found to have effective conductivity in the tested flows and the underpressure created allowed the suction of the gases above the ground. At a flow of 150 cubic meters/h, a negative pressure of 74 millibars was measured and the impact radius reached up to 10 meters from the suction well.
- Since the average distance between the wells ranged from 4 to 6 m, there was compatibility between the remediation method, the site characteristics and the existing pilot remediation infrastructure.
- According to the pilot findings, it appears that when operating the pump from all the wells, the entire contaminated soil cell intended for treatment will be underpressure and therefore no additional wells need to be installed.

### 3.4 Off gas Treatment

In order to select the appropriate treatment technology for the airflow from the SVE system, a number of technologies defined as "BAT" (best available technology) (by the EPA) were examined:

1. adsorption on activated carbon
2. thermal oxidation
3. biological filter
4. vapour condensation

Due to the high daily load of organic hydrocarbons, we recommend gas treatment with a thermal oxidation- **catalytic oxygen** method suitable for the treatment of emission stream at concentrations higher than several hundred PPM. Laboratory tests found no evidence of the presence of chlorinated hydrocarbons which can be a limiting factor when using this technology due to the fear of causing damage to the catalytic converter.



### 3.5 Control parameters

- To estimate the load of hydrocarbons pumped from the wells when the SVE system is working, performed gas sampling of several wells together and from a number of individual wells in which high PID values were detected. Some of the samples were performed on canisters sent for TO-15 analysis.
- In order to evaluate the effectiveness of the treatment for the gas pumped from the wells treated by the thermal oxidizer, a sampling was performed on the stack of the treatment facility.

## 4. Full-scale application

The full-scale system is compatible with the system built in the pilot and described in the previous sections

### 4.5 Control parameters

- Throughout the period the system operates, there was regular monitoring once every two weeks of parameters of the system and the soil and once every few months a performed laboratory analysis of TO-15 to the concentrations in the gas stream pumped from the soil.
- The following is the test that is performed every two weeks:
  1. The VOC concentration measured in the well by the PID.
  2. Checking the flow in the pumped stream.
  3. Measuring the pressure in the well.



## 6. Post treatment and/or Long Term Monitoring

### **6.1 Post treatment and/or Long Term Monitoring**

In order to test the effectiveness of the treatment after its completion, a "rebound effect" test was performed, which included shutting down the system for about a month and a half and restarting it for two months.

The test revealed that the concentrations did not rise and there was no change in the concentrations in the various wells after reopening, with respect to values measured before closing. These findings indicate that the treatment performed on the soil is effective and the volatiles that were adsorbed to the soil have already been treated.



## 7. Additional information

### 7.1 Lesson learnt

From the results of the cost-benefit analysis, it can be seen that due to the low concentrations pumped from the soil during the period when the concentration of contaminants decreased, led to high power consumption to operate the system, significantly, as more energy has to be invested in heating the catalyst.

Increased use of electricity to heat the catalyst in the converter causes that per kilogram of pollutant treated emitted into the air during the power generation process at the IEC power plant about half a kilogram of nitrogen oxides and half a kilogram of sulphur oxides.

As the treatment of the site with the SVE method achieved, and the meaning of continued pumping and gas treatment has low efficiency on the one hand and on the other hand requires a lot of energy, its significant environmental consequences with regard to electricity generation emissions.

### 7.2 Additional information

The SVE system operated for about 9,000 hours during which it handled about 5,641 liters of hydrocarbons.

As part of the treatment, about 4,000,000 cubic meters of soil gases were extracted from the ground in the treated area of about 2,000 cubic meters.

### 7.3 Training need

Training through workshops, preferably by the Ministry of Environmental Protection in order for the remediation processes to comply with the regulator's guidelines.

## 1. Contact details - CASE STUDY: SVE n.8

<b>1.1 Name and Surname</b>	VION Mathieu (Expert at Technical Direction) DEVIC-BASSAGET Boris (Technical Director)
<b>1.2 Country/Jurisdiction</b>	FRANCE
<b>1.3 Organisation</b>	SUEZ RR IWS REMEDIATION FRANCE
<b>1.4 Position</b>	Head Office : 17 rue du Périgord, 69330 Meyzieu (France)
<b>1.5 Duties</b>	Engineer - Expertise department manager
<b>1.6 Email address</b>	<a href="mailto:mathieu.vion@suez.com">mathieu.vion@suez.com</a> ; <a href="mailto:boris.devic-bassaget@suez.com">boris.devic-bassaget@suez.com</a> <a href="mailto:contact.remediation.europe@suez.com">contact.remediation.europe@suez.com</a>
<b>1.7 Phone number</b>	+33(4)72450222



## 2. Site background

### 2.1 History of the site

CHIMICOLOR is the former operator of a 1,500 m<sup>2</sup> site located in the town of La Garenne Colombes, in the outskirts of Paris, whose activity involved industrial painting on various supports.

The site is located in a mixed residential and tertiary district, bounded by:

- Apartment buildings on the west side;
- Apartment buildings on the south sides and is separated by a road and pedestrian crossing alley to access the entrance to a residential parking lot;
- A street on the north side, then apartment buildings beyond that street.

According to the information collected, the site was mainly occupied by the following activities:

- 1928 - 1971: Exploitation of the site by a company which carried out the repair and the assembly of electric refrigerators;
- 1971 - 1992: Operation of the premises by a company specializing in the chemical and electrochemical treatment of metals;
- 2001 - 2012: the company CHIMICOLOR becomes the operator of the site and carries out printing activities on aluminium plates, chemical colouring of aluminium plates, stainless steel engraving and screen printing. The cessation of activity took place in 2012.

The site deconstruction work was carried out between May and July 2014. The facade of the building in the north-west part has been preserved as well as the old administrative buildings.

In addition, during the month of July 2014, the soils located to the right of the south-eastern part of the site had been the subject of earthworks to a depth of 1.2 m.

The area to be cleaned up was in the south-eastern part of the land, covering an area of approximately 250 m<sup>2</sup>.





## 2.2 Geological setting

According to the geological map of Paris and the data from the basement database (BSS), the geological context in the sector considered is as follows:

- Old quaternary alluvium;
- Limestone of Saint-Ouen made up of marls and limestone banks over a depth of 10 to 15 m;
- Then the sands of Beauchamp, with a thickness of 6 to 7 m.

The various investigations carried out on the site revealed the following average lithological section:

- From 0 to 1 m: predominantly sandy embankments;
- From 1 to 8 m: a layer of sands becoming marly from a depth of 4 m;
- From 8 m: limestone.

According to information taken from the subsoil database (BSS) and the hydrogeological map of the Paris basin, several water tables are present under the treatment area:

- The Saint-Ouen limestone aquifer, whose piezometric level was established at about 16 m deep;
- The Beauchamp sands aquifer, the piezometric level of which was established at about 24 m deep.

According to the groundwater quality monitoring campaigns carried out in 2012 and 2013, the water levels at the site were recorded between 15.7 and 16.4 m deep in the limestone water table of Saint-Ouen. Due to the location of the site in a bend of the Seine, 2 km north-west and south-east of the site, the flow direction is variable, with a very low hydraulic gradient.



## 2.3 Contaminants of concern

The investigations carried out on the site before the start of the works made it possible to characterize the impact on the right of the area to be decontaminated.

The results summarized below indicated the presence of a tetrachlorethylene impact (PCE):

- In soils. This impact mainly concerned surface soils down to a depth of 1 m (contents at the level of the S6B hole of the order of 4.3 mg/kg). The maximum level (6.7 mg/kg) was observed between 4 and 5 m deep at the level of a borehole located at the level of the former product storage area. The vertical extension of the pollution in the soils was not delimited beyond 6 m of depth but the detection of PCE in the groundwater seemed to suggest that this impact had locally migrated towards the groundwater;
- In soil gases at the level of the most superficial horizons between 0 and 5 m deep. The various campaigns carried out had made it possible to measure PCE contents of between 7.5 and 1,435 mg/m<sup>3</sup>;
- In groundwater in the area of structures located in the area but also on a structure outside the site right-of-way. Studies prior to 2014 revealed PCE contents varying between 3,900 and 8,300 µg/l. According to the groundwater quality monitoring campaigns dating back to 2015 at the site, the PCE contents varied between 100 and 4,100 µg/l. Previous studies had also revealed the presence in small quantities of PCE degradation by-products including trichloroethylene (contents between 0.37 and 8.5 µg/l) and dichloroethylene (content of 4.9 µg/l).



## 2.4 Regulatory framework

The decontamination work was undertaken with the aim of improving the quality of the underground environment (unsaturated zone) before the construction of residential buildings.

As part of this project, the decontamination objectives initially selected, on the basis of data relating to the state of the available environments, were as follows:

- Partly southeast of its site => Excavation of part of the land. According to the predictive analysis of the residual risks carried out in January 2014 by a consulting firm, the only measurement of excavation of the earth at a depth of 3 m was supposed to make it possible to obtain an admissible residual risk within the framework of the redevelopment project of the site (service provided by SUEZ RR IWS REMEDIATION FRANCE in December 2015).
- Forced extraction of PCE present in the soils and in the gaseous state in the air from the soil between the final excavation slope (-3 m compared to the natural ground) and the roof of the limestone of Saint-Ouen (located approximately 8 m deep). The objective of this operation was not to achieve compatible residual risks (which had already to be reached after the excavation work carried out to a depth of 3 m) but to pursue the elimination of the pollution more in depth, with a view to improving the quality of the environments. The initial objective was to achieve an 80% reduction in the mass content of PCE determined in soil gases before the start of treatment with SVE. To achieve this goal, the SVE treatment was scheduled to work over a period of 3 to 6 months.

## 3. Pilot-scale application in field

We did not carry out a pilot sizing test prior to the implementation of the soil vapour extraction treatment.



## 4. Full-scale application

### 4.1 Extraction system

In view of the environmental, geological and hydrogeological context of the site, to treat the source of soil pollution in the area of the former chemical storage area of the CHIMICOLOR plant at La Garenne Colombes, the choice fell on the implementation of an in situ treatment by SVE. This technique had the most relevant technical and economic interest in meeting the objectives of a rapid improvement in the quality of the subsoil.

The forced extraction of gases from the soil was accomplished using 9 wells implanted up to 6 meters deep from the bottom of the excavation, including 2 m in solid tubes and 4 m in screened tubes.

This configuration was determined from the pollution and soil characterization data made available and using sizing assumptions such as:

- The absence of a surface coating (concrete or coated slab) in line with the impacted area;
- A soil permeability estimated at  $5 \cdot 10^{-6}$  m/s;
- Unit extraction rates of 2 to 15 m<sup>3</sup>/h;
- A vacuum at the head of each well less than 150 mbar;
- A provisional treatment period of 6 months.

The unit has been sized so as to be able to ensure a maximum total extraction flow of 660 m<sup>3</sup>/h for a maximum total depression of 350 mbar, compatible with the assumptions stated above.

The installation of the treatment wells was carried out in such a way as to densify the footprint of the treatment wells in the area of the highest impact (premises for chemical etching, storage of products).

The plan below shows the location of SVE wells and treatment facilities.

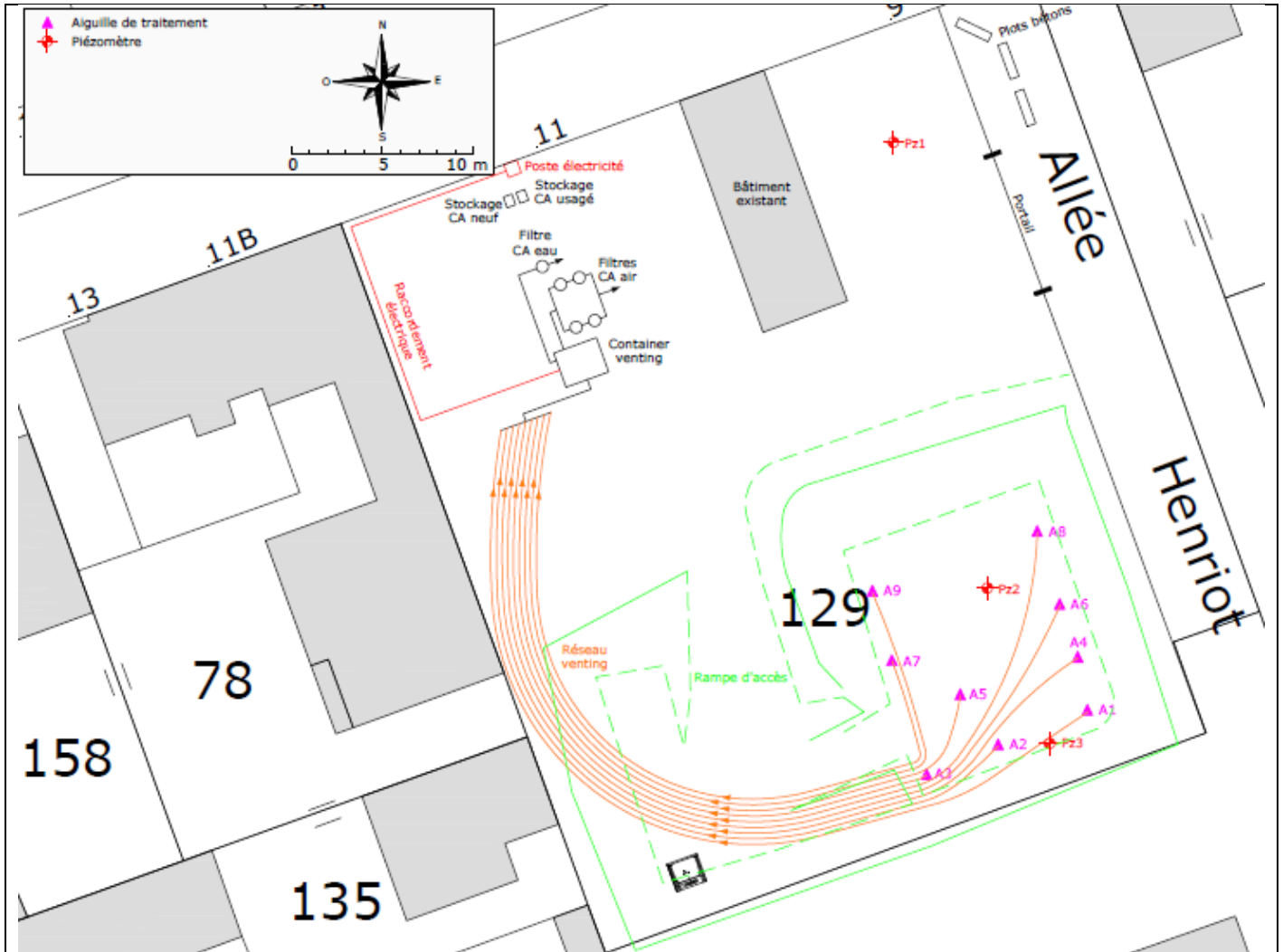

Layout plan for wells and facilities



Photograph of SVE treatment facilities



## 4.3 Radius of influence

Prior to the commissioning of the treatment, SUEZ RR IWS REMEDIATION FRANCE implemented SVE tests in order to determine the characteristics specific to each well (optimal depression/flow rate) and to estimate the permeability of the unsaturated zone to the areas to be treated and thus determine the radius of influence of each well. These data were intended to confirm the sizing of the installation and optimize its performance.

Two types of SVE tests were carried out:

- Staged tests;
- A so-called "long-term" test carried out for 30 hours.

### Staged tests

The objective of a step-by-step test is to determine the optimum vacuum/flow rate pair of the wells. During these tests, the air from the ground was extracted in stages of increasing depressions ranging from 200 to 350 mbar recorded at the level of the extractor. Five successive stages lasting 15 minutes were performed for each hand.

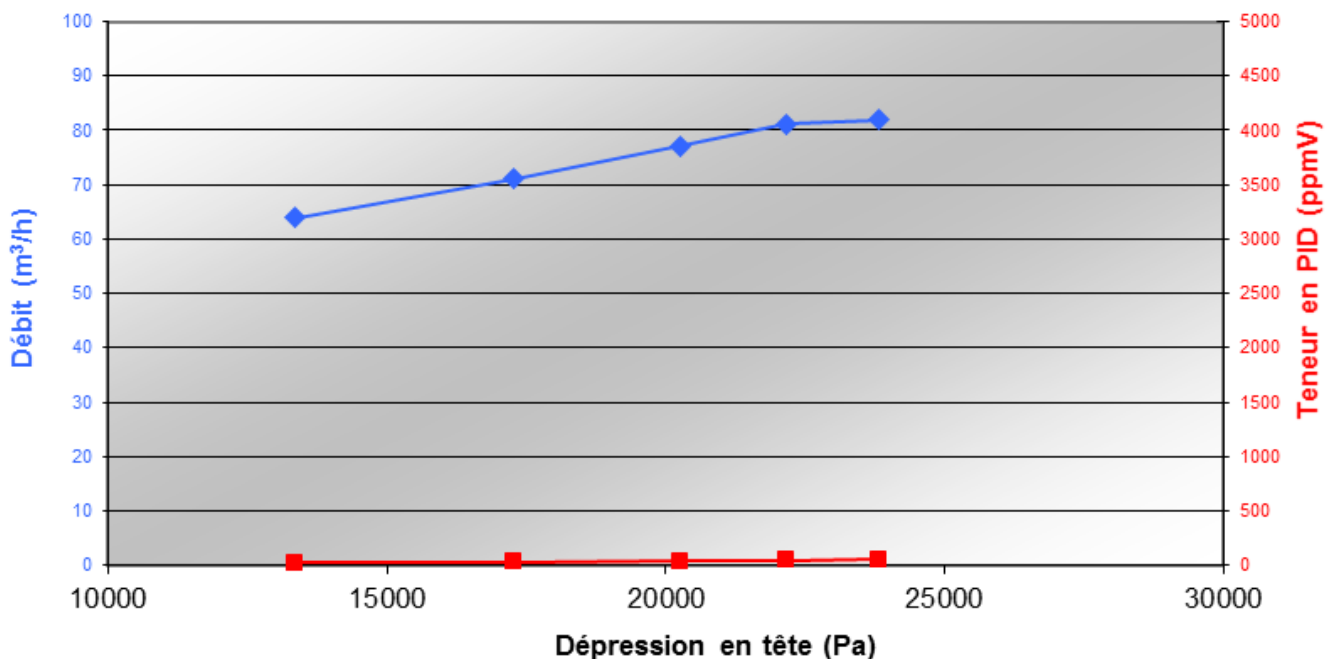

Vacuum/flow and vacuum/VOC content pairs for well A9

During the tests, regular monitoring (every 5 minutes) of the following parameters was



carried out:

- Extractor depression;
- Pressure difference in the flow measurement system (diaphragm device);
- Temperature, humidity and semi-quantitative VOC contents of the extracted gases.

For each well, vacuum/flow and vacuum/VOC content pairs could be determined. By way of example, the figure below corresponds to the depression/flow rate and depression/VOC content pairs measured from well A9.

The extraction flow rate increases steadily, going from 64 Nm<sup>3</sup>/h for a depression of 13.367 Pa to 81 Nm<sup>3</sup>/h with a depression of 22.167 Pa. From this last value, and despite an increase depression, the extraction flow hardly increases any more. For 23 833 Pa of depression, the observed flow rate is 82 Nm<sup>3</sup>/h. An asymptote is then observed. The optimum pressure/flow rate pair of the well is therefore of the order of 80 Nm<sup>3</sup>/h for a depression applied at the head of the structure of the order of 22.000 Pa. Well A9 is considered to be a productive well.

The semi-quantitative VOC contents in the gases extracted from this well are not very high compared to the other well tested. The minimum measured concentration is 24 ppmv at step 1 and the maximum concentration is 50 ppmv at step 5.

A summary of the measurements carried out at each well during the stepwise tests is presented in the table below. They correspond to the optimal extraction rate associated with a given depression.

Aiguilles	A1	A2	A3	A4	A5	A6	A7	A8	A9
<b>Dépression optimale appliquée à l'ouvrage (mbar)</b>	190	150	200	<140	240	200	190	230	220
<b>Débit d'extraction optimal (Nm<sup>3</sup>/h)</b>	57	37	44	40	43	36	41	41	81
<b>Teneurs semi-quantitatives PID moyennes (ppmv)</b>	623	429	143	3319	168	335	79	92	37

So-called "long-term" test

The advantage of the "long-term" test is that it can estimate the effective permeability



to air of the soils of the unsaturated zone in line with the zone to be treated. This parameter is essential for determining the radius of influence of each well under operating conditions.

The test was carried out on well A5 which was located in the centre of the area to be treated. The other 8 wells were located between 3.4 and 9.6 m from well A5. A fixed vacuum of 240 mbar was applied for 30 hours from well A5 and semi-quantitative measurements of VOCs and depressions were carried out at close frequency at the start of the test (every 5 minutes) and less frequently by thereafter, on each control well. The defined value of the applied vacuum (240 mbar) was determined by the step test. For well A5, the optimum depression is not known (it is less than 14,000 Pa). On the other hand, at such a depression, we were sure to apply to the well its optimum flow rate estimated at around 40 Nm<sup>3</sup>/h.

#### Estimation of effective air permeability

In order to determine the effective permeability to air of the treatment zone ( $k_a$  expressed in m<sup>2</sup> or permeability K expressed in m/s), various analytical solutions (more or less complex) are proposed in the literature. The configuration of the extraction well and the control wells of the area to be treated made it possible to use the adaptation of Dupuit's solution. This simplified relation derived from that for groundwater flow is used to represent the radial flow of air in steady state.

As the adaptation of Dupuit's solution was only valid in a steady state, the test was extended until the differential pressure values were obtained which were stable over time at the level of the control wells.

The calculated effective air permeability is 9.10<sup>-4</sup> m/s. The value obtained is greater than the value used during sizing (5.10<sup>-6</sup> m/s). This difference made it easier to reach the objectives by allowing more air volume to be extracted from the ground than expected.

#### Estimation of influence radii

By definition, the theoretical influence radius (R1000) of SVE wells corresponds to the radius in which the soil air (pore volume) is renewed at least 1000 times per year. The radius of influence depends on several factors including the geometry of the extraction system, the air permeability of the soil, the water content of the soil and the type of surface coating. Typically, R1000 can range from 2m (for fine soils) to 30m (for granular soils) for a single extraction well.

It should also be noted that the radii of influence of the wells are greater if the ground surface is waterproof (covered with bitumen or concrete), which is not the case in the treatment area of the CHIMOCOLOR site.

A calculation tool internal to SUEZ RR IWS REMEDIATION FRANCE makes it possible to





determine the estimated permeability values by taking advantage of the adaptation of Dupuit's solution. This same tool makes it possible to predict the extractable flow by considering the permeability value, the characteristics of the tested well (depth, length of the screened interval, etc.) and the depression applied at the head of the well. If the flow rate measured at the end of the long-term test is of the same order of magnitude as the calculated flow rate, then the estimated permeability value can be validated.

The results obtained at the end of the long-term test are presented in the table below.

Work	Applied depression	Estimated permeability	Measured extraction flow	Flow calculated according to permeability
AT 5	240 mbar	$9.10^{-4}$ m/s	107.4 Nm <sup>3</sup> /h	168.1 m <sup>3</sup> /h

The permeability value estimated during the long-term test is consistent with regard to the nature of the soils (sands, marls, limestone).

The flow calculated from the permeability estimate is greater than the measured extraction flow (approximately 60 m<sup>3</sup>/h). The geology of the soils could suggest the presence of preferential flows. They are liable to vary the depressions at the head of wells and the unit flows. In addition, the flow rate of 107.4 m<sup>3</sup>/h measured during the "long-term" test is also greater than the flow rate of 43 m<sup>3</sup>/h measured on well A5 during the step tests. These two measured flow rates show the high productivity of well A5 and are much higher than the unit flow rates taken into account for the sizing (between 2 and 15 m<sup>3</sup>/h), which goes in the direction of better efficiency of the treatment.

The permeability thus obtained makes it possible to estimate the radius of influence of each well under operating conditions.

The table below compiles the values of the influence radius obtained under operating conditions of the SVE treatment.

### Summary of the radius of influence calculated under operating conditions

Work	Depression applied at the well head (mbar)	Measured extraction flow (Nm <sup>3</sup> /h)	Radius of influence (m)
A1	27.8	29.9	7.1
A2	29.5	24.5	6.7
A3	32.3	33.8	7.3
A4	43.6	28.9	7
AT 5	28.2	32.1	7.2
A6	41.4	21.3	6.4
A7	36.5	31.0	7.1
AT 8	27.8	36.5	7.5
A9	27.6	28.5	7

The radius of influence obtained from the long-term test and the first operating data are between 6.4 and 7.5 m. Knowing that the maximum distance between two wells is 5 m, the calculated radius make it possible to validate the dimensioning of the SVE well network (number and positioning), namely a total coverage of the area of 250 m<sup>2</sup> in the south-eastern area of the site.

The mapping of the influence radius of SVE wells is presented in the following plan.

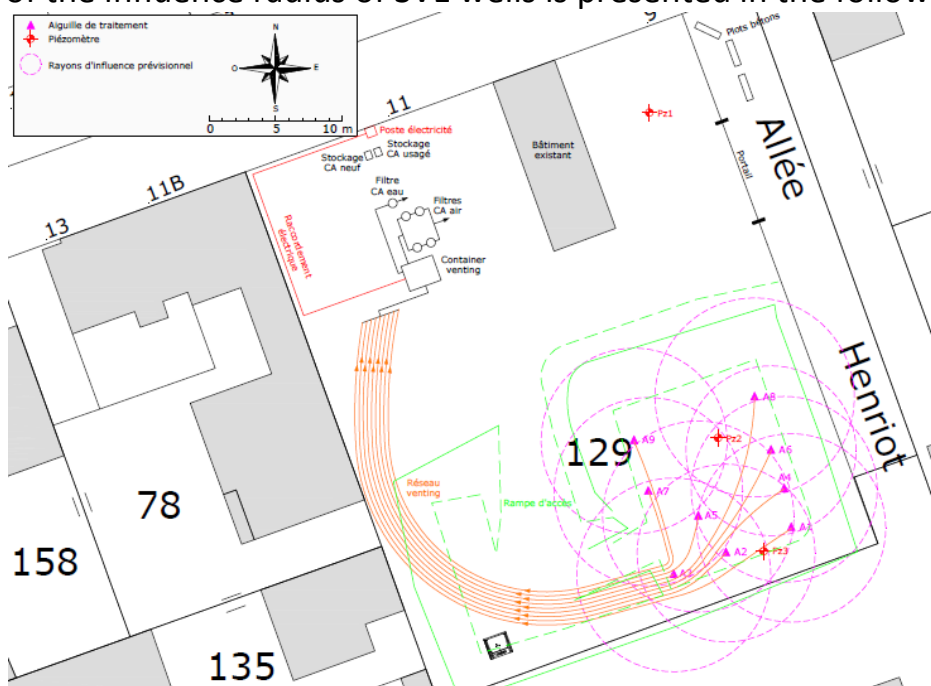



## 4.4 Off gas Treatment

The technical-economic analysis, based on the projected mass balance of the treatment, made it possible to demonstrate that the treatment of the gases extracted on activated carbon was the most economical solution, while allowing a significant reduction in the contents of volatile pollutants.

The initial choice of SUEZ RR IWS REMEDIATION FRANCE fell on a filtration line made up of two series of two 200-liter activated carbon filters arranged in parallel and connected in a common outlet (capacity of 80 kg of activated carbon per filter ). When the activated carbon from the filters placed at the head reached saturation, said filters were emptied, tipped over at the end of the filtration line and then supplemented with healthy activated carbon. Such a device made it possible to measure the VOCs content in the air flow at the outlet of each barrel in order to effectively control the gaseous discharge into the atmosphere and free us from any exceeding of the limit value. In addition, this gaseous effluent treatment device guaranteed reduced downtime for the installation in order to change the activated carbon.

The contaminated activated carbon was evacuated to an approved treatment channel (hazardous waste storage facility).

## 4.5 Control parameters

The figure, below, presents in the form of histograms, the air extraction volume flow rates recorded during monitoring as well as the curve representing the evolution of the cumulative volume of extracted air during the period devoted SVE treatment.

### Evolution of the extraction volume flow rates of the treatment unit and the total volume of extracted air

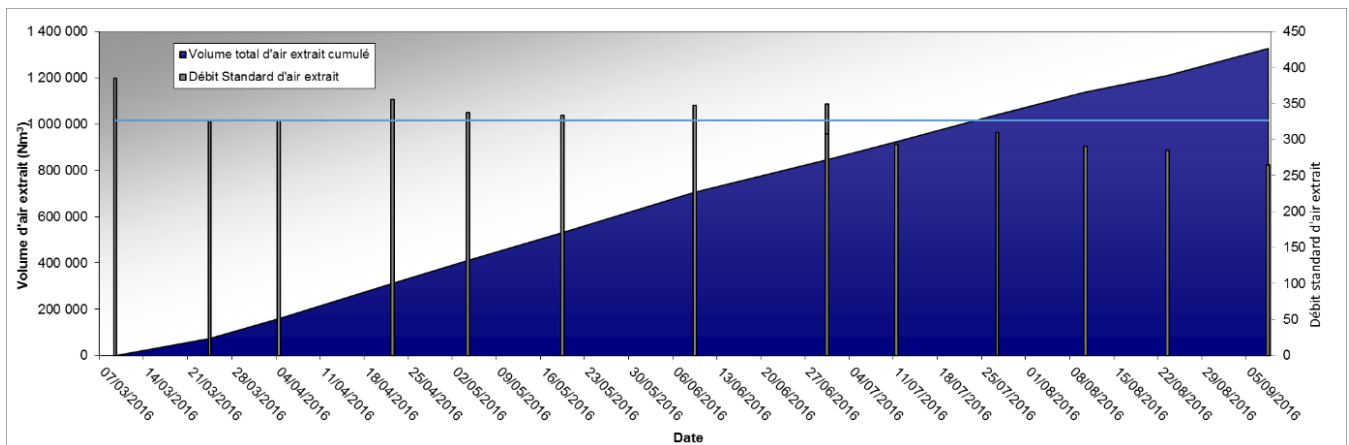

At the end of the operating period of the SVE unit:

- The average volume flow rate of air extraction estimated over the six months of operation is 327 Nm<sup>3</sup>/h (blue line shown in the figure above);
- The total volume of air extracted from the ground is estimated to be approximately 1,328,000 Nm<sup>3</sup>.

The figure below shows the evolution of the volume contents of VOCs measured by means of a photo ionization detector (PID) in the air flow extracted from each of the treatment wells as well as in the global air flow input to the unit during the operating period of the SVE treatment.

### Evolution of the volume contents of VOCs in the air flow extracted from each treatment well

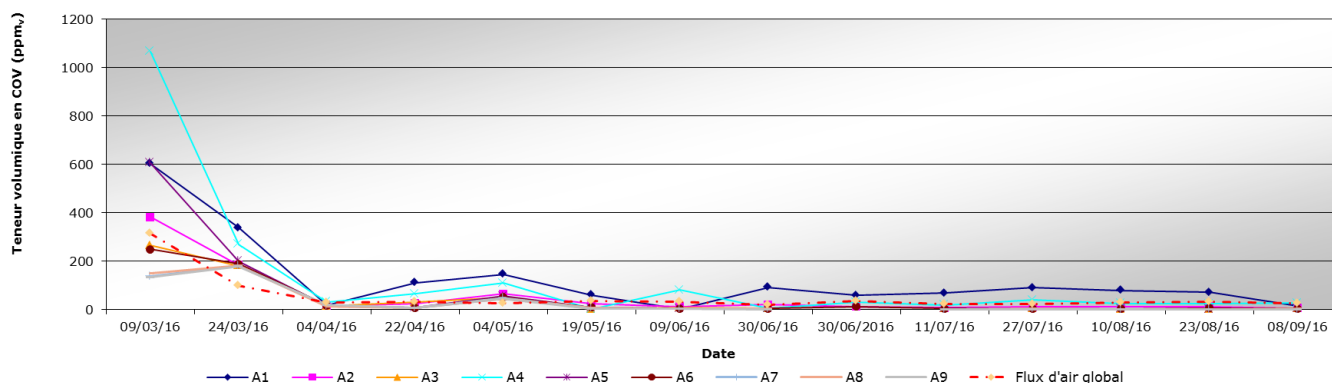

The volumetric VOC contents remained relatively stable after the significant decrease observed during the first month of treatment. After 6 months of treatment, the extracted air streams exhibited contents ranging between 1.1 ppmv for well A9 and 26.6 ppmv for well A4.

Monthly, air sampling, on a suitable sampling support (activated carbon tube) was carried out at the inlet of the activated carbon filtration device. This sampling made it possible to determine, through the performance of laboratory analyzes, the mass contents of VOCs in the overall air flow extracted from the ground via the treatment wells.

The table below compiles the analytical results obtained from the samples taken during the period devoted to SVE treatment.

### Mass content of VOCs in the extract air flow

	09/03/2016	04/04/2016	04/05/2016	09/06/2016	11/07/2016	10/08/2016	08/09/2016
Unité	mg/Nm <sup>3</sup>	mg/Nm <sup>3</sup>	mg/Nm <sup>3</sup>	mg/Nm <sup>3</sup>	mg/Nm <sup>3</sup>	mg/Nm <sup>3</sup>	mg/Nm <sup>3</sup>
1,2-dichloroéthane	<SQ	<SQ	<SQ	<SQ	<SQ	<SQ	<SQ
1,1-dichloroéthène	<SQ	<SQ	<SQ	<SQ	<SQ	<SQ	<SQ
cis-1,2-dichloroéthène	<SQ	<SQ	<SQ	<SQ	<SQ	<SQ	<SQ
trans 1,2-dichloroéthylène	<SQ	<SQ	<SQ	<SQ	<SQ	<SQ	<SQ
dichlorométhane	<SQ	<SQ	<SQ	<SQ	<SQ	<SQ	<SQ
1,2-dichloropropane	<SQ	<SQ	<SQ	<SQ	<SQ	<SQ	<SQ
1,3-dichloropropène	<SQ	<SQ	<SQ	<SQ	<SQ	<SQ	<SQ
tétrachloroéthylène	1490,8	193,6	107,4	101,0	66,6	74,2	99,2
tétrachlorométhane	<SQ	<SQ	<SQ	<SQ	<SQ	<SQ	<SQ
1,1,1-trichloroéthane	0,7	0,2	0,1	0,1	0,1	0,1	0,6
trichloroéthylène	2,0	0,3	0,1	0,1	0,1	0,1	0,2
chloroforme	<SQ	<SQ	<SQ	<SQ	<SQ	<SQ	<SQ
chlorure de vinyle	<SQ	<SQ	<SQ	<SQ	<SQ	<SQ	<SQ
hexachlorobutadiène	<SQ	<SQ	<SQ	<SQ	<SQ	<SQ	<SQ
bromoforme	<SQ	<SQ	<SQ	<SQ	<SQ	<SQ	<SQ
<b>TOTAL COHV</b>	1493,5	194,1	107,6	101,2	66,7	74,4	100,0
Teneur PID lors du prélèvement	315,0	32,1	26,0	27,0	28,0	29,0	30,0
Pourcentage d'abattement sur les COHV totaux par rapport au 09/03/2016	NA	87%	93%	93%	96%	95%	93%



<SQ: below the quantification threshold

NA: Not applicable

During the follow-up on September 8, 2016, i.e. before stopping the treatment device, the tetrachlorethylene content (a compound present at 99% in the air flow since the start of the treatment) had significantly increased compared to the levels determined from the samples from July 11 and August 10, 2016.

The total COHV content determined during the monitoring of September 8, 2016 was 100 mg/Nm<sup>3</sup> and revealed a reduction percentage of 94% compared to the content measured on March 9, 2016, the day treatment was started.

An indicative value of the total mass of pollutants extracted could be calculated on the basis of analytical monitoring and air volumes extracted from the soil by the SVE system. The calculations only take into account the organic compounds analyzed.

The table below shows the detail of the estimate of the masses of VOCs extracted from the ground, in gaseous form, by the SVE device, on the basis of the data collected from the start of the treatment until its stop, the September 08, 2016. The average concentration over each period was calculated from the two air samples taken at the inlet of the activated carbon filters and limiting the monitoring period.

### Mass balance of pollutants extracted from the ground by the SVE device since the start of treatment

Paramètre	Unité	1 <sup>er</sup> mois de suivi	2 <sup>ème</sup> mois de suivi	3 <sup>ème</sup> mois de suivi	4 <sup>ème</sup> mois de suivi	5 <sup>ème</sup> mois de suivi	6 <sup>ème</sup> mois de suivi
		Du 09/03/2016 au 04/04/2016	Du 04/04/2016 au 04/05/2016	Du 04/05/2016 au 09/06/2016	Du 13/06/2016 au 11/07/2016	Du 11/07/2016 au 10/08/2016	Du 10/08/2016 au 08/09/2016
Volume d'air extrait période	Nm <sup>3</sup>	158 680	251 512	294 716	217 678	216 489	188 984
Concentration moyenne en COHV sur la période (échantillonnage mensuel)	mg/Nm <sup>3</sup>	843,8	150,8	104,4	84,0	70,6	87,2
Masse totale en COHV extraite période	kg	134	38	31	18	14	16
Taux d'extraction journalier	kg/j	5	1	1	1	0,5	0,6
Masse totale extraite cumulée	kg	134	172	203	221	235	251

As of September 8, 2016, the date of termination of the SVE treatment system, it is estimated that approximately 251 kg of VOCs were extracted from the soils in gaseous form.

## 6. Post treatment and/or Long Term Monitoring

### 6.1 Post treatment and/or Long Term Monitoring

Following the six months of treatment and in accordance with the acceptance strategy for the decontamination works, a statement of the quality of the soil gases was carried out monthly for 3 months from each treatment well in order to quantify the level of pollution. of soil gases by VOCs and to monitor the possible evolution of the levels, once the device has been shut down.

Evolution of the volume contents of VOCs in static conditions from the initial state (09 March 2016) until the last monitoring campaign of the reception phase (06 December 2016)

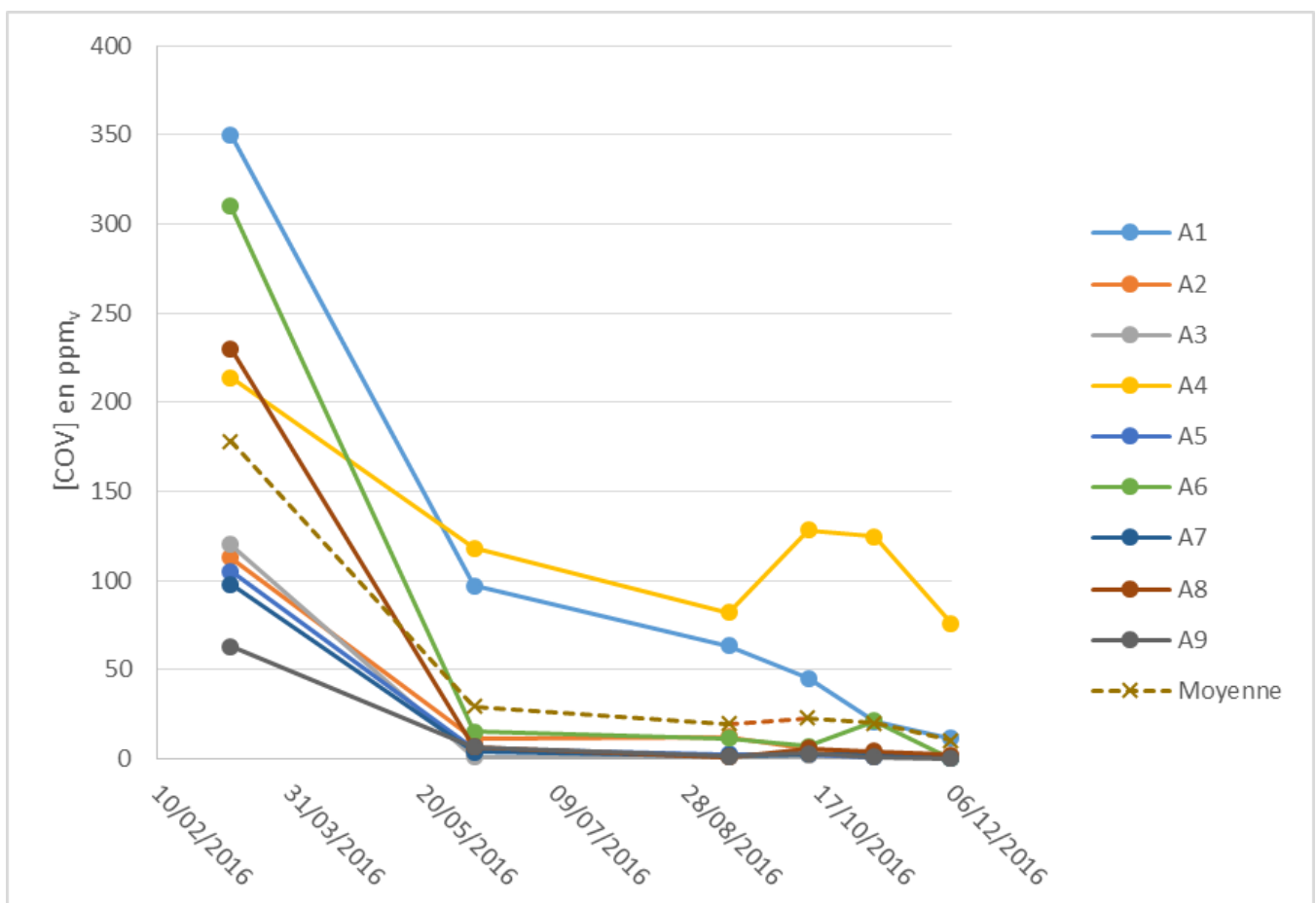

**Evolution of the VOC mass contents under static conditions from the initial state (09 March 2016) to the last monitoring campaign of the reception phase (06 December 2016)**

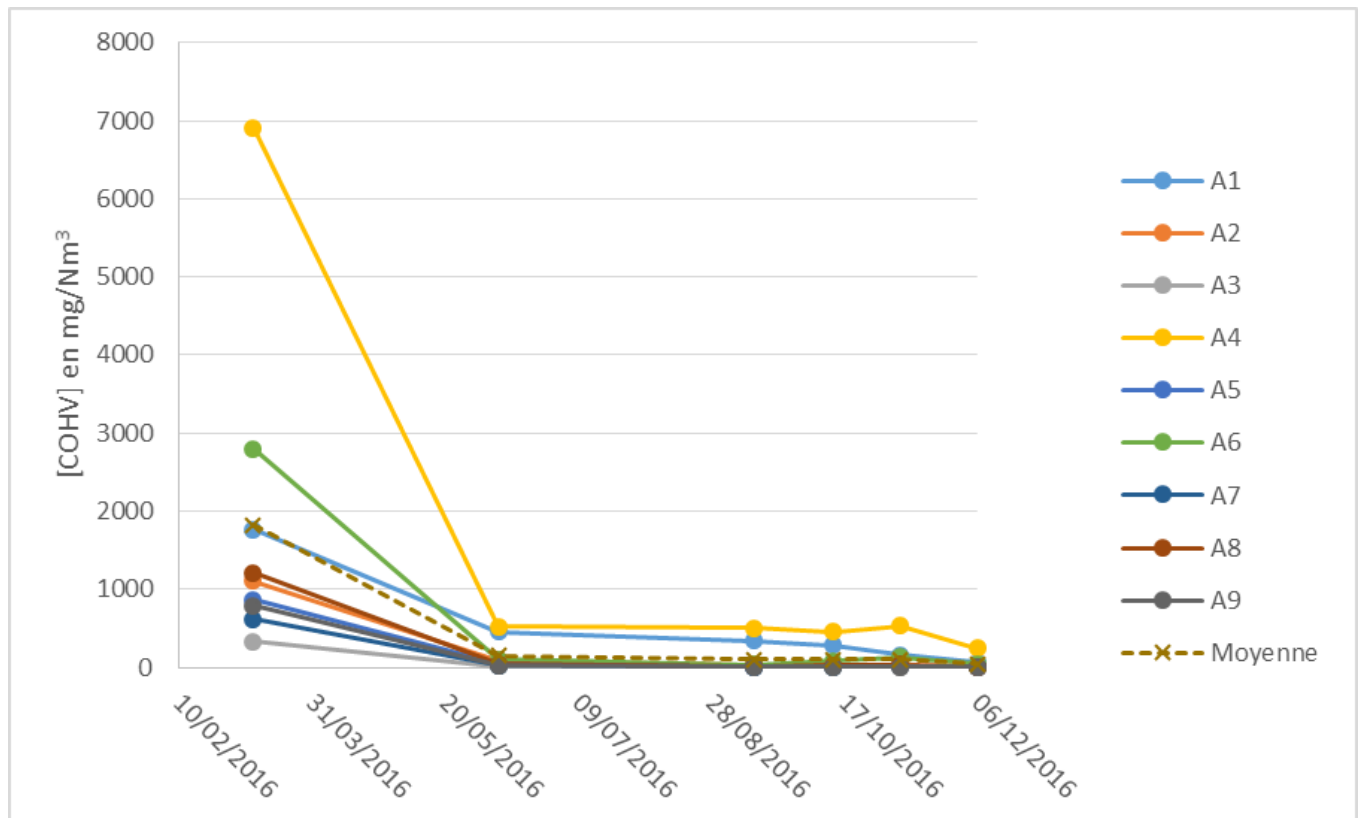

After 6 months of treatment, the average VOC content in the soil gases sampled from the 9 SVE wells was 108.23 mg/Nm<sup>3</sup>. This value remains relatively high. Despite everything, in comparison with the value obtained before the start-up of the installations, the reduction rate of the average of the total VOC contents amounts to 94%. The results obtained demonstrated good efficacy of the treatment.

The VOC contents in the soil gases sampled from each of the 9 wells ranged, after 6 months of treatment, between 3.04 mg/Nm<sup>3</sup> for well A3 and 507.36 mg/Nm<sup>3</sup> for well A4. All the wells exhibited an abatement rate greater than 93%, with the exception of well A1 which exhibited an abatement rate of 81% for a measured concentration of 338.04 mg/Nm<sup>3</sup>.

The treatment of soil gases by SVE was stopped at the end of the soil gas sampling campaign carried out on September 13, 2016, in accordance with the work acceptance strategy. The operating mode consisted of keeping the installation shut down for a period of 3 months. During this period, and in a manner identical to the samples taken





during the initial state and after 3 and 6 months of treatment, soil gas samples at the 9 wells were taken and analyzed on a monthly basis.

After 3 months of stopping treatment, the average VOC content in the soil gases sampled from the 9 SVE wells was  $42.86 \text{ mg/Nm}^3$ . This value is lower in comparison with the value obtained after stopping treatment, on September 13, 2016 and in comparison with the values obtained after one and two months of stopping, on October 13 and November 7, 2016. In the end, the reduction rate for the average VOC content is 98%, which corresponds to a significant reduction rate, clearly higher than the target (80%). The VOC contents in the soil gases sampled from each of the 9 wells range, after three months of shutdown, between  $1.97 \text{ mg/Nm}^3$  for well A9 and  $245.04 \text{ mg/Nm}^3$  for well A4. All the wells had an abatement rate greater than 97%.

At the end of the final soil gas quality monitoring campaign carried out on December 6, 2016, tetrachlorethylene still remains the majority compound. We can also note that 1,1,1-trichloroethane was measured in trace amounts at wells A4, A5, A6 and A8. Likewise, trichloroethylene was also measured in trace amounts in the area of wells A1, A4, A5, A6, A8 and A9.

## 1. Contact details - CASE STUDY: SVE n.9

<b>1.1 Name and Surname</b>	VION Mathieu (Expert at Technical Direction) DEVIC-BASSAGET Boris (Technical Director)
<b>1.2 Country/Jurisdiction</b>	FRANCE
<b>1.3 Organisation</b>	SUEZ RR IWS REMEDIATION FRANCE
<b>1.4 Position</b>	Head Office : 17 rue du Périgord, 69330 Meyzieu (France)
<b>1.5 Duties</b>	Engineer - Expertise department manager
<b>1.6 Email address</b>	<a href="mailto:mathieu.vion@suez.com">mathieu.vion@suez.com</a> ; <a href="mailto:boris.devic-bassaget@suez.com">boris.devic-bassaget@suez.com</a> <a href="mailto:contact.remediation.europe@suez.com">contact.remediation.europe@suez.com</a>
<b>1.7 Phone number</b>	+33(4)72450222



## 2. Site background

### 2.1 History of the site

The site where the SVE clean-up project was carried out is confidential.

The site is located in the Ile-de-France region, in France. The site covers an area of several hectares and corresponds to a multidisciplinary research and innovation centre. The activities carried out concern many fields such as nuclear energy, life sciences, material sciences, climate and environment, technological research and education. The area of the site mainly affected by the presence of VOCs (mainly trichloroethylene – TCE) in the subsoil is located in the extreme south-eastern part of the centre.

### 2.2 Geological setting

The geological and hydrogeological information collected during the previous studies are reported in the following table.

Geological information	Hydrogeological information
<p>The horizons intersected by the wells on site are successively:</p> <ul style="list-style-type: none"> <li>• a very poorly permeable cover formation, corresponding to plateau silts and grindstone clays, with a thickness of around 12 m;</li> <li>• the Fontainebleau sands, corresponding to very well classified fine sands (particle size of 500 to 600 <math>\mu\text{m}</math>); the thickness of Fontainebleau sands formation is around 50 m; a carbonate and clayey horizon, with a thickness generally between 1 and 2 m, is present in the upper part of the Fontainebleau sands formation, at a depth of the order of 14 to 15 m.</li> </ul>	<p><b>Aquifers:</b> formation of the Fontainebleau sands</p> <p><b>Static level:</b> the free surface of the water table is intercepted at a depth of 40 m.</p> <p><b>Flow direction/gradient:</b> the flow of the groundwater table is directed towards the south</p> <p><b>Hydrodynamic data:</b> no data is available</p>



## 2.3 Contaminants of concern

Under the effect of the diffusion within the Fontainebleau sands, which are very permeable to air and which are isolated from the atmosphere by a confining geological layer of a dozen meters thick, a halo of VOCs (mainly trichloroethylene - TCE) was formed within the pore space of the Fontainebleau sands, in the sector of the main source zone identified, that is to say in the extreme south-east of the site.

The TCE halo partially dissolves on contact with groundwater. The plume of VOCs, multi-source and multi-pollutant, affects groundwater at the scale of the site.

Pollution characterization data remain unknown, namely:

- the position of the historical area of solvent infiltration in the subsoil;
- The nature and quantities of the VOCs that have reached the subsoil;
- the nature of the polluting events that led to the infiltration of VOCs into the subsoil.

## 2.4 Regulatory framework

The main objective of the client is to improve the quality of groundwater and overall improve the quality of the underground environment, with a view to reducing the sources of pollution of the underground environment in accordance with the French national methodology for the rehabilitation of sites and soils polluted.

To achieve this, the client commissioned the company SUEZ RR IWS REMEDIATION FRANCE to carry out the forced extraction of TCE present in the gaseous state in the air from the soil between 15 and 40 m deep, within the Fontainebleau sands formation, in the south-eastern part of the site.

## 3. Pilot-scale application in field

We did not carry out a pilot sizing test prior to the implementation of the soil vapour extraction treatment.

## 4. Full-scale application

### 4.1 Extraction system

The forced extraction of gases from the ground was accomplished from the three wells named F51, PG-05 and PG-08. These wells are respectively 50 m, 20 m and 30 m deep in relation to the surface. The screened intervals of these wells intercept the Fontainebleau sands. The treatment unit was dimensioned so as to be able to ensure a maximum extraction flow rate per well of the order of 150 to 200 m<sup>3</sup>/hour. In addition, given the configuration of the screened intervals of the PG-05 and PG-08 wells, SUEZ RR IWS REMEDIATION FRANCE has provided specific plugs and wellheads in order to selectively extract gases from the soil in the Fontainebleau sands formation overlying or underlying the carbonate and clay horizon generally intersected between 14 and 16 m deep.

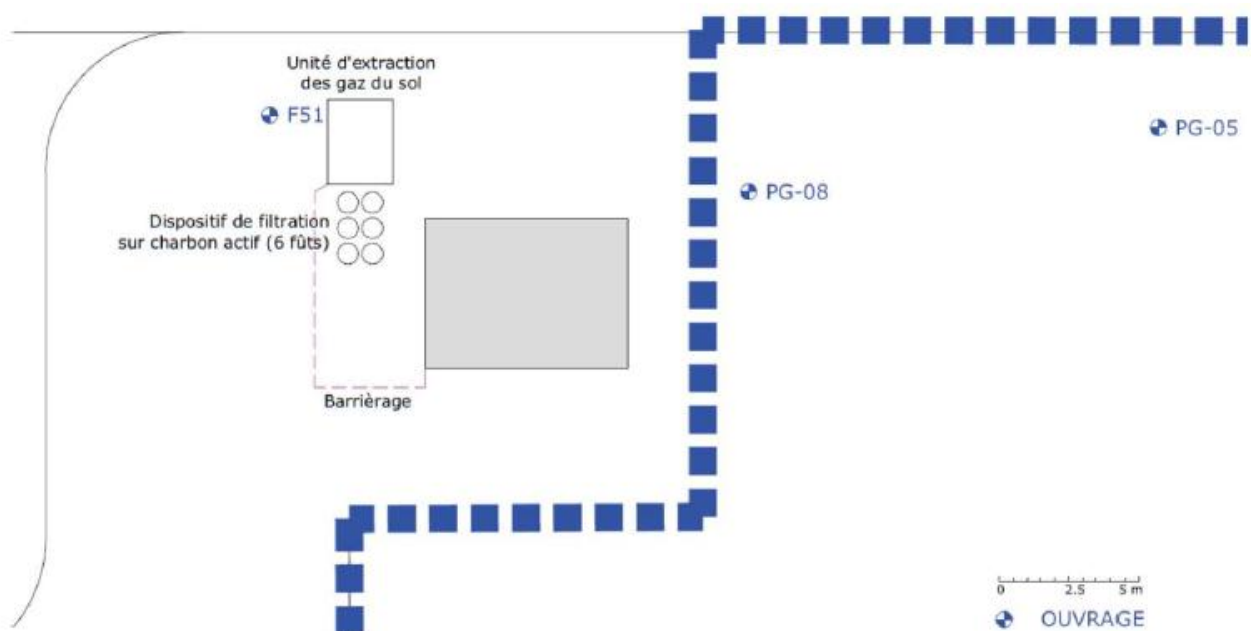

**Layout plan for wells and facilities**

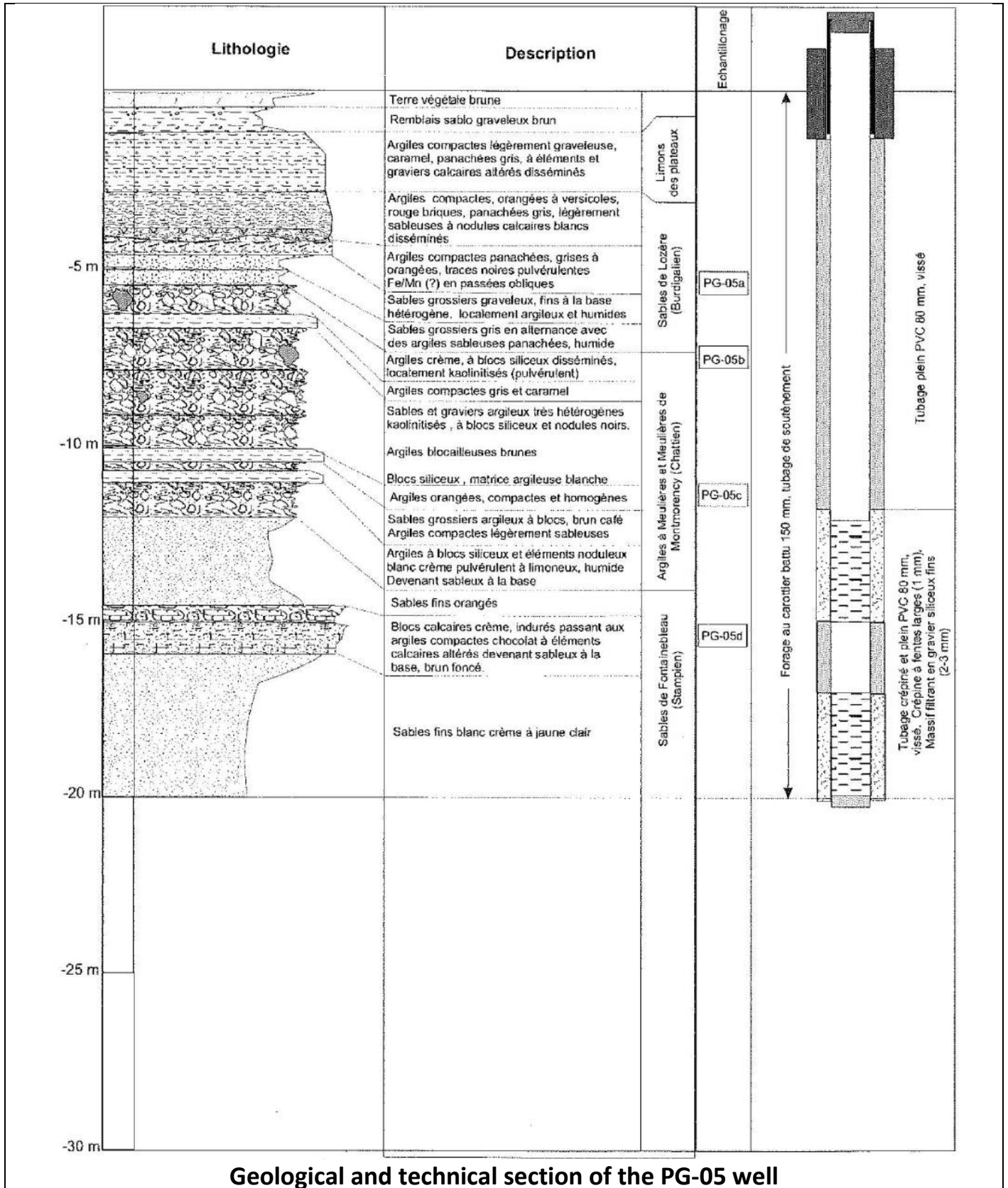

Geological and technical section of the PG-05 well



### **4.3 Radius of influence**

We did not determine the radius of influence of the treatment wells in the context of this project.

## 4.4 Off gas Treatment

The technical-economic analysis, based on the forecast mass balance of the treatment, has shown that the treatment of gases extracted on activated carbon is the most economical solution, while allowing a significant reduction in the content of volatile pollutants.

The choice of SUEZ RR IWS REMEDIATION FRANCE fell on two parallel filtration lines, each of the lines being made up of three 200-liter activated carbon filters arranged in series (capacity of 75 kg of activated carbon per filter). When the activated carbons from the two drums placed at the head reached saturation, said drums were emptied, tipped at the end of their respective filtration line and then supplemented with healthy activated carbons. The soiled activated carbons were packaged in big bags. Each big-bag will be completed with 400 to 600 kg of activated carbon.

The VOC content in the air flow at the outlet of each drum has been measured to effectively control the gaseous discharge to the atmosphere and to avoid any exceeding of the discharge criteria.

## 4.5 Control parameters

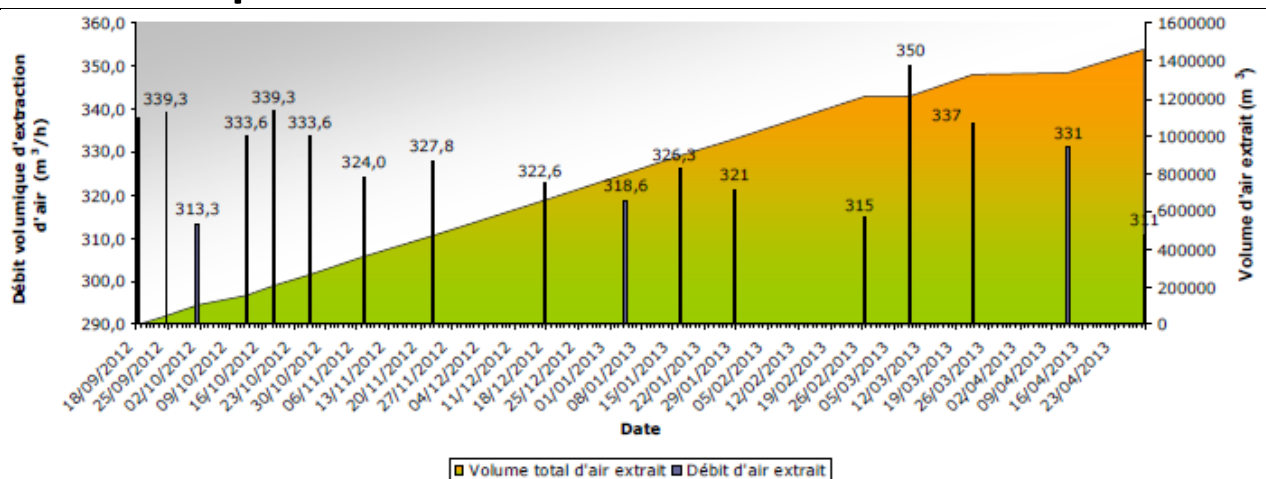

**Evolution of the extraction volume flow of the treatment unit and the total volume of air extracted from the ground**



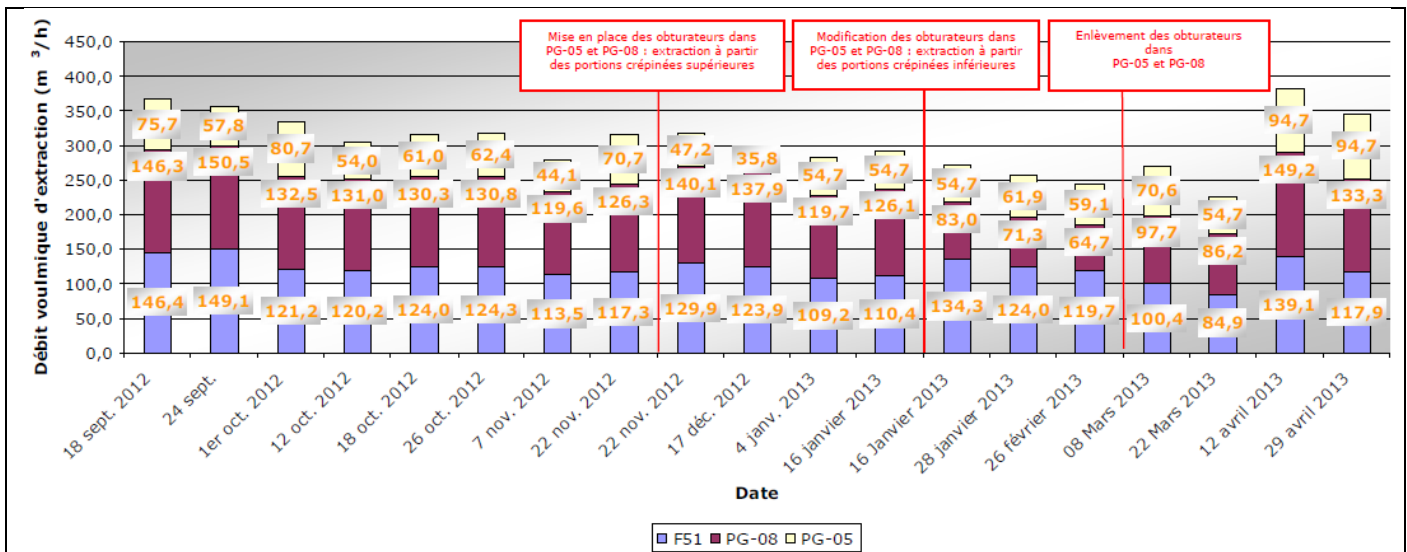

**Evolution of the air extraction volume flow of each treatment well**

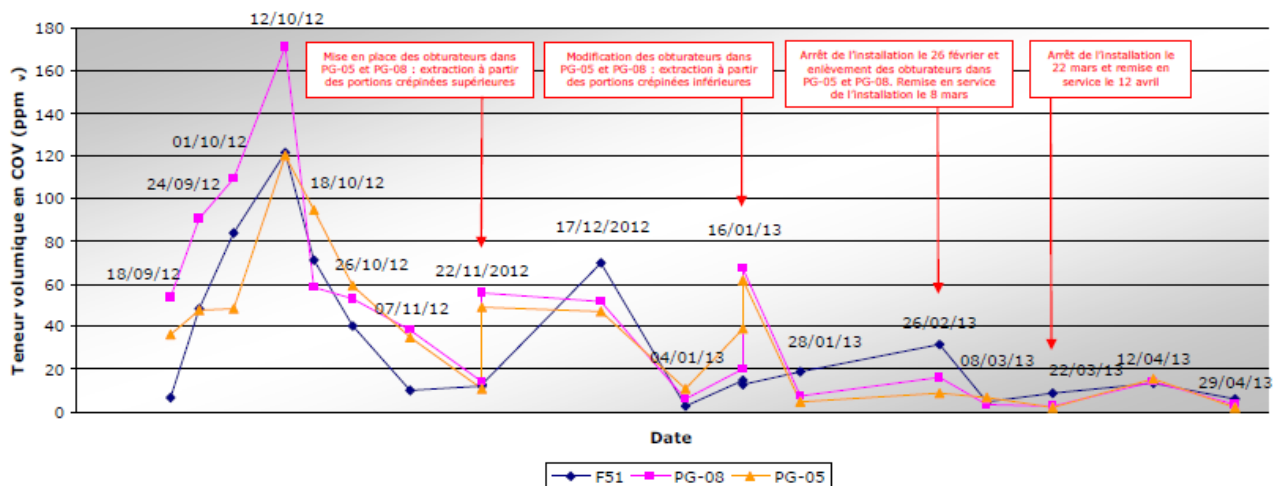

**Evolution of the volume contents of VOCs in the air flow extracted from each treatment well**

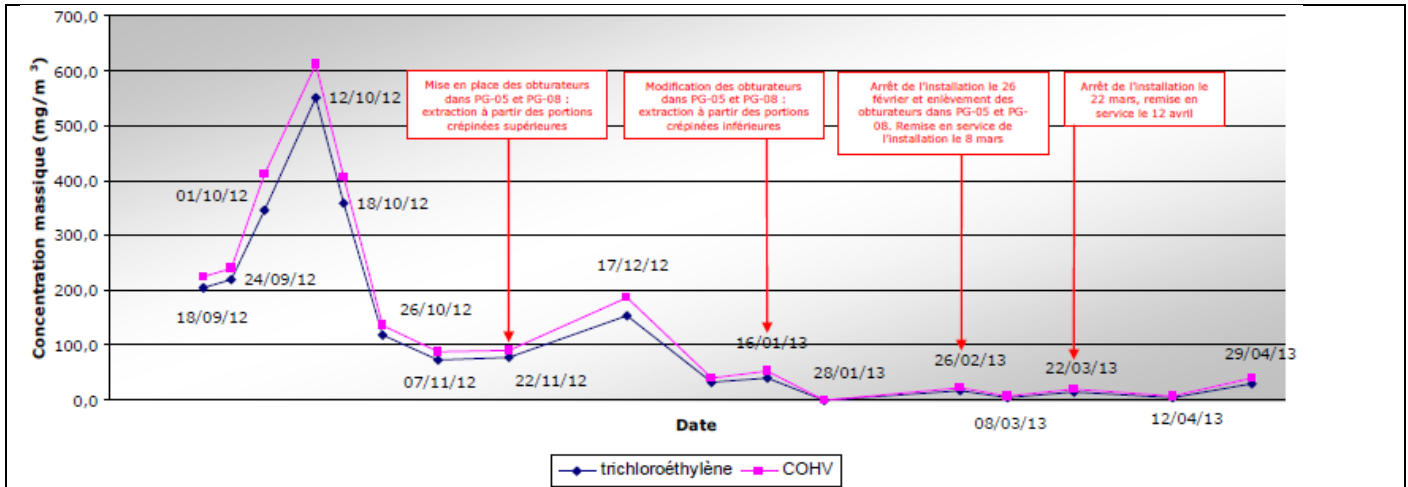

**Evolution of the mass content of trichlorethylene in the air flow extracted from the ground**

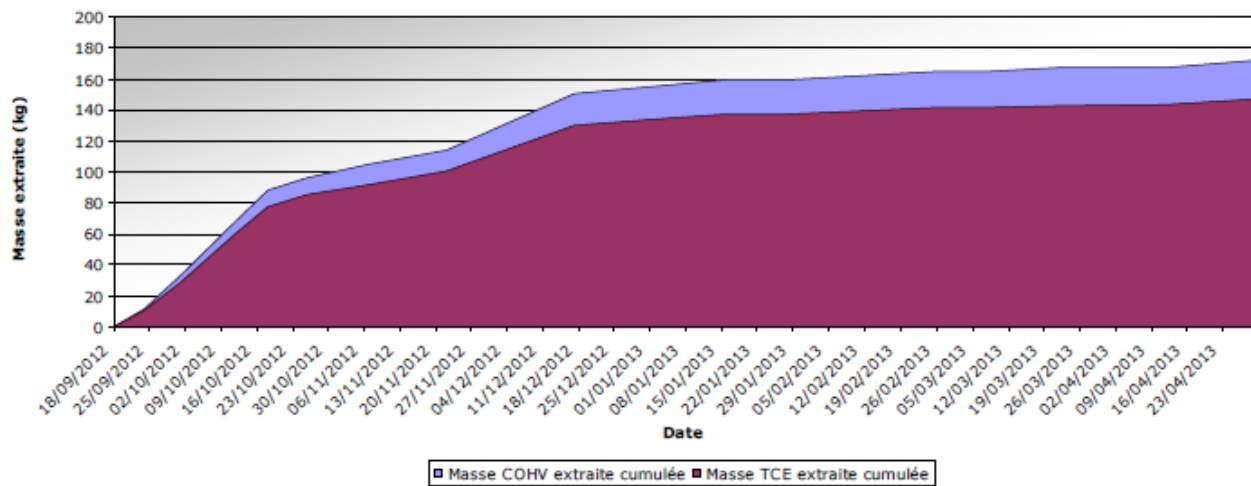

**Evolution of the masses of VOCs and TCE extracted from the ground by the soil vapor extraction treatment, according to analytical monitoring**



## 5. Enhancements to SVE

### 5.2 Any other enhancement

Apart from the use of shutters and specially designed well heads during treatment for the PG-05 and PG-08 wells (as a reminder, in order to carry out a selective extraction of gases from the soil in the Fontainebleau sands formation overlying or underlying the carbonate and clay horizon generally intersected between 14 and 16 m deep), SUEZ RR IWS REMEDIATION FRANCE has not implemented other improvements to the SVE system.

## 7. Additional information

### 7.1 Lesson learnt

Controlled project, without particular constraints to be met. The SVE treatment made it possible to achieve the asymptote of recovery of TCE in the horizon of the Fontainebleau sands. The client did not communicate to SUEZ RR IWS REMEDIATION FRANCE the analytical results from the groundwater monitoring but had nevertheless shared the information that the quality of the groundwater at the level of the piezometer located directly downstream of the treatment zone was improved.

## 1. Contact details - CASE STUDY: SVE n.10

<b>1.1 Name and Surname</b>	Simone De Fazio <sup>1</sup> – Corrado Thea <sup>2</sup>
<b>1.2 Country/Jurisdiction</b>	Italy
<b>1.3 Organisation</b>	Golder Associates S.r.l.
<b>1.4 Position</b>	<sup>1</sup> Geologist – <sup>2</sup> Environmental engineer
<b>1.5 Duties</b>	Italian Environmental laws (D.Lgs 152/06)
<b>1.6 Email address</b>	sdefazio@golder.it – cthea@golder.it
<b>1.7 Phone number</b>	+39 011 2344200

## 2. Site background

### 2.1 History of the site

The Site is an ex industrial plant operating from the '50s to 2009, when it has been re-located because the area has become almost completely residential.

The remediation procedure for the Site started at the beginning of the 2000s, because a facility downstream from the Site was found to be impacted by an incoming chlorinated solvents contamination. Since 2000 soil and groundwater were largely investigated and a remediation activity was performed from 2011 to 2013.

In 2017 pilot tests were undertaken in order to address the PCE contamination detected in soil and groundwater. The selected technologies are Enhanced Reductive Dechlorination for GW and SVE for soil. Due to good results achieved in pilot tests, a full scale remediation was performed at the beginning of 2019 and it's still ongoing.



Site Aerial map with monitoring wells

## 2.2 Geological setting

Site soil consists of gravel and sand, interbedded with thin layers of sandy silt. The depth to groundwater is approximately 20 meters below ground surface (bgs).







## 2.3 Contaminants of concern

The main contaminant is tetrachlorethylene (PCE), detected in soil and groundwater. Trichloroethylene (TCE), 1,2 dichlorethylene (1,2-DCE) and Vinyl chloride (VC) are also present, as PCE degradation products.

In soil PCE was detected in concentration of about 1000 mg/kg. PCE in soil gas was up to 4900 mg/m<sup>3</sup>.

The remediation target for the Site was calculated by a human health risk assessment and for the soil matrixes is a soil gas target (because of the vapour inhalation risk) and it is equal to 110 mg/m<sup>3</sup> for PCE, at the sub slab pins installed underneath the building and 2000 mg/m<sup>3</sup> at the soil gas probes installed outdoor.

## 2.4 Regulatory framework

The main environmental law in Italy is the Legislative Decree no. 152/2006 (D.Lgs 152/06) that in Part four, Title fifth sets specific rules for remediation of contaminated sites.

The reference legislation establishes some threshold values (CSC D.Lgs 152/06 and limits DM31/15) for the main contaminants both in soil and groundwater; if during the characterization there are one or more exceedance of threshold values, the site is defined "potentially contaminated", and a human health risk assessment can be developed to estimate the risks deriving from the potential sources of contamination detected on site (defined by the samples with exceedance) and to calculate risk-based site-specific threshold limits (CSR). The legislature also fixes which are the values of acceptable risk for the assessment.

If the estimated risks are lower than acceptable values, the site is defined "not contaminated", and no remediation is needed. If the estimated risks are higher than acceptable values, the site is defined "contaminated", and remediation is needed. The risk based site-specific threshold limits (CSR) are the remediation targets.





### 3. Pilot-scale application in field

#### 3.1 Extraction system

A SVE pilot test was performed in a not vertical well drilled with a 10° plunge (from vertical), up to 16.5 m bgs, right underneath the underground tank that were the primary contamination source; the screened interval is positioned from 8 m to 16.5 m bgs, to target the residual contamination below the source area as indicated by previous investigations.

The test was conducted connecting the well (SVEa) to a blower and then applying a vacuum on the extraction well. Vapor flow rate, vacuum and VOC, O<sub>2</sub>, CO<sub>2</sub> and CH<sub>4</sub> concentrations were measured in the extraction well and in 4 nearby soil gas probes. A stepped rate test and a constant rate test was conducted on the test well. In the stepped rate test, each step was carried out for 30 minutes, at increasing flow rates (70, 95, 124 and 164 m<sup>3</sup>/h). During the constant rate test the maximum flow rate (164 m<sup>3</sup>/h) was used for a longer time (300 minutes).

Vacuum and VOC, O<sub>2</sub>, CO<sub>2</sub> and CH<sub>4</sub> concentration measured in soil gas probes was used to assess the Radius of Influence (“ROI”) of the SVE.

#### 3.5 Control parameters

Vapor flow rate, vacuum and VOC, O<sub>2</sub>, CO<sub>2</sub> and CH<sub>4</sub> concentrations were measured in the extraction well and in 4 nearby soil gas probes during the test.

In the graph below the VOC measured during the constant rate test. 5000 ppm is the over range value of the field gas detector.

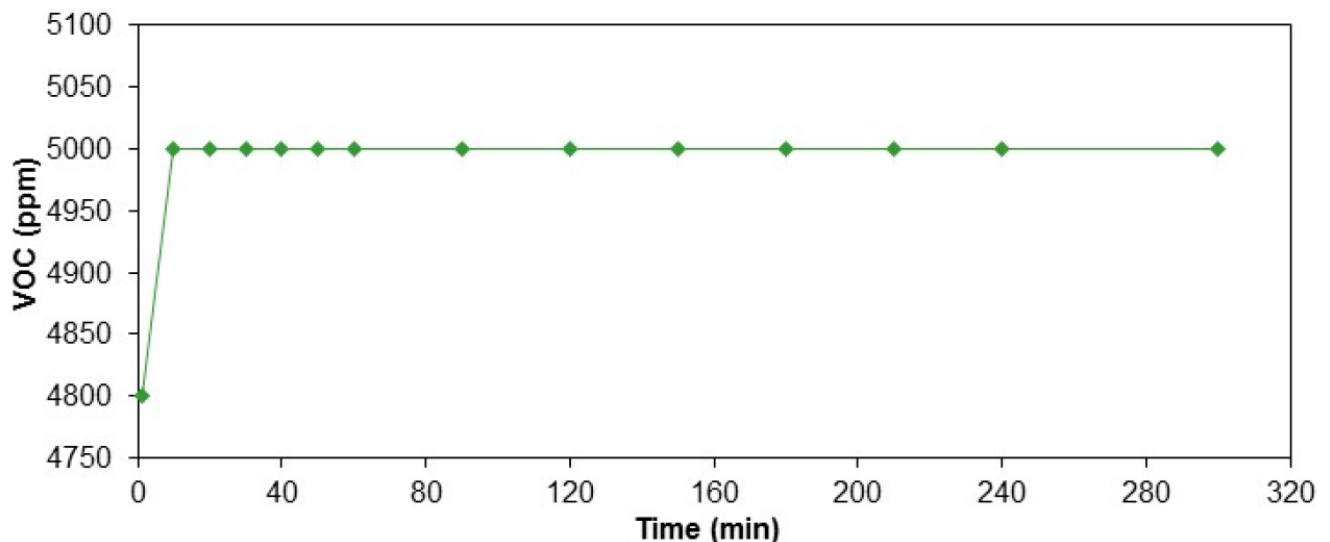

## 4. Full-scale application

### 4.1 Extraction system

The SVE system used included the following equipment:

- 1 non vertical well (SVEa), 3" in diameter, 16 m b.g.s. deep, 10° inclination;
- 3 vertical wells (SVEb÷SVEd), 3" in diameter, 9 m b.g.s. deep and located 12.5 m one from the other;
- 3 venting trenches, about 30 m long, located at 1 m bgs under the building basement floor and with a 7 m distance one from the other; each trench is composed by a HDPE pipe, screened, 4" in diameter, draining gravel, a protection sand layer and concrete;
- a blower and related vessels and piping, connected to a vapour treatment unit,
- vapour treatment unit composed of 3 Granular Activated Carbon ("GAC") filters.
- In addition, a HDPE vapour membrane was installed in the basement of the building to prevent subsoil vapour intrusion in the building basement and to increase the effectiveness of SVE action.

The schematic of the extraction venting trench is below.

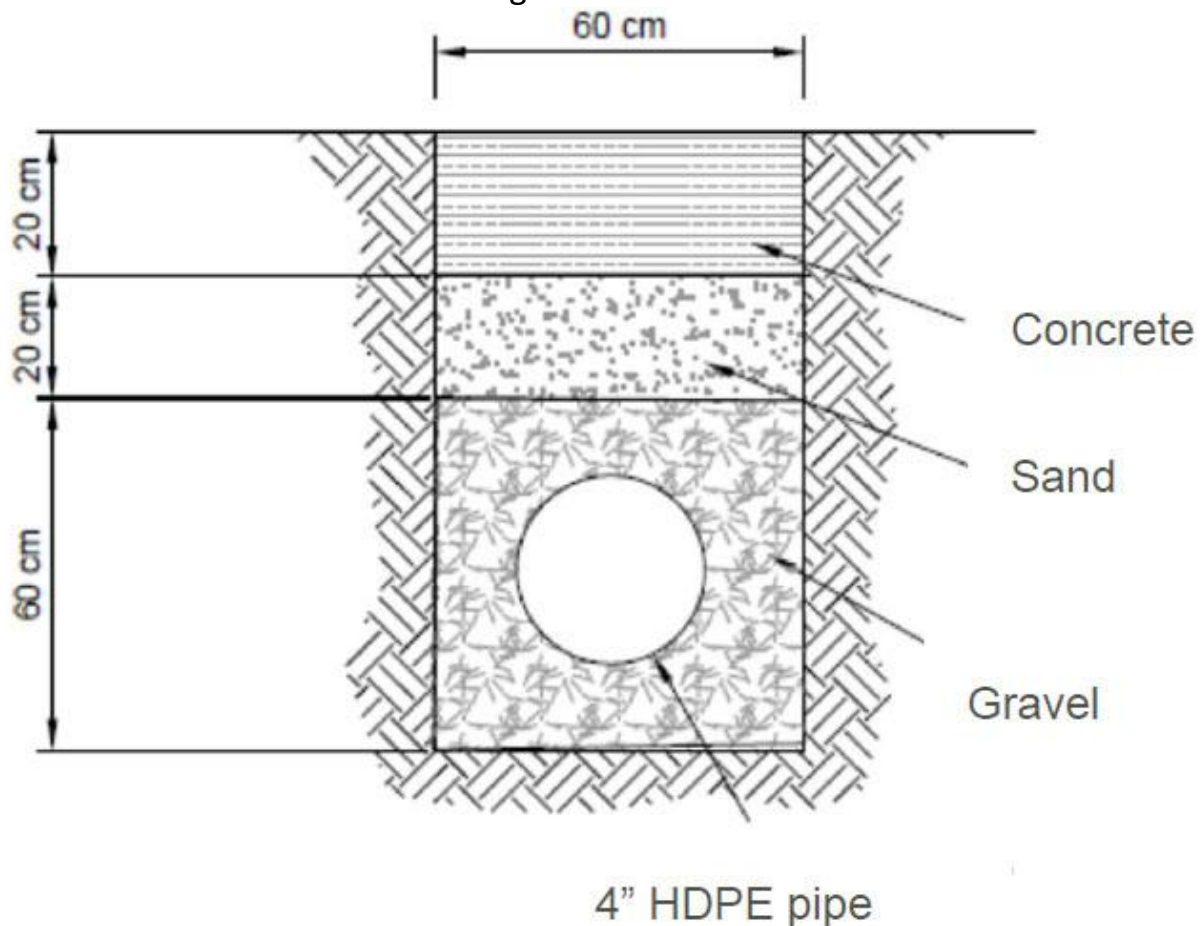

## 4.3 Radius of influence

Radius of influence (ROI) was calculated on the basis of induced vacuum and the pilot test results. The extracted flow is different for each extraction well in order to achieve the desired ROI: about 11-14 meters SVEa, about 7 meters SVEb-d.



## 4.4 Off gas Treatment

Activated carbon adsorption was used to remove all contaminants from the air stream; filters consist in 3 iron tanks, 150 cm high (270 cm with legs), 127 cm diameter, containing 800 kg of GAC each, connected in series.

The replacement of the GAC is scheduled based on the routine monitoring of VOC at the inlet and outlet of the system (see Chapter 4.5).

Off gas monthly monitoring at GAC filters outlet showed 0 ppm values over all the operational period, thus confirming the effectiveness of the off-gas treatment.



## 4.5 Control parameters

In addition, the SVE system has been equipped with a device that allows the continuous remote control of the operating parameters.

The PCE concentration decreased of 1 to 2 order of magnitude after 1 year of operation of the system and now is less than 10 ppm. Soil gas concentrations achieved remediation goal in all monitored soil gas probes.

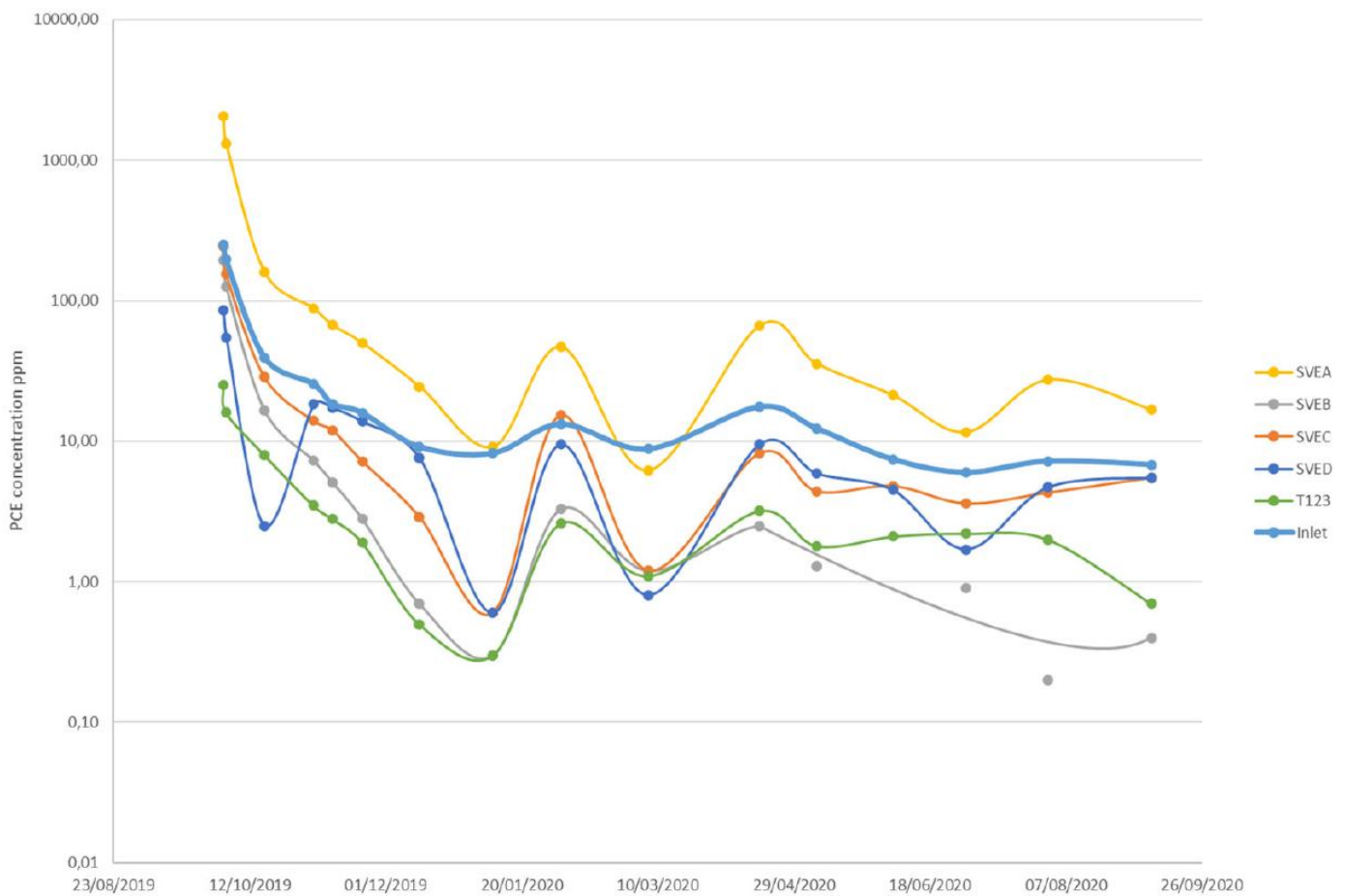



## 6. Post treatment and/or Long Term Monitoring

### 6.1 Post treatment and/or Long Term Monitoring

In compliance with the Remediation Plan, the SVE system was operated for 12 months up to asymptotic concentrations. After the shutdown of the system soil gas and sub slab sampling round was undertaken in order to verify the effectiveness of the SVE operation; further sampling campaigns are planned biannually for 2 years to confirm the reduction of the contaminants concentration in soil gas.

Results of the first soil gas and sub slab sampling undertaken after shutting down the SVE system showed concentrations below detection limits in all samples.

## 7. Additional information

### 7.1 Lesson learnt

During the remediation design it was invested in understanding deeply the Site Conceptual Model and in particular the secondary source; thus the remedial action targeted specifically and successfully the impacted source.

## 1. Contact details - CASE STUDY: SVE n.11

<b>1.1 Name and Surname</b>	Valentina Sammartino Calabrese
<b>1.2 Country/Jurisdiction</b>	Italy
<b>1.3 Organisation</b>	ARPA Campania
<b>1.4 Position</b>	Technical Collaborator
<b>1.5 Duties</b>	
<b>1.6 Email address</b>	
<b>1.7 Phone number</b>	

## 2. Site background

### 2.1 History of the site

The area is located on the eastern outskirts of the city of Naples, in an area characterized by a high population density and the presence of numerous industrial activities, most of which are abandoned. In particular, there are hydrocarbon management activities, dedicated almost exclusively to storage, as refining activities have now ceased, manufacturing industry, engineering, production of services. The area is located within the Eastern Naples SIN, established in 1998.

There is a protocol for the entire area of the SIN "Program agreement for groundwater remediation" which provides that the P.A. takes over the remediation of the groundwater in place of the responsible parties who adhere to it (once the health risk for workers is excluded).

There are also technical protocols for environmental characterization activities developed by the PA.

In the past, the site was annexed to a large fuel storage area, currently it carries out storage and sale of automotive fuels.

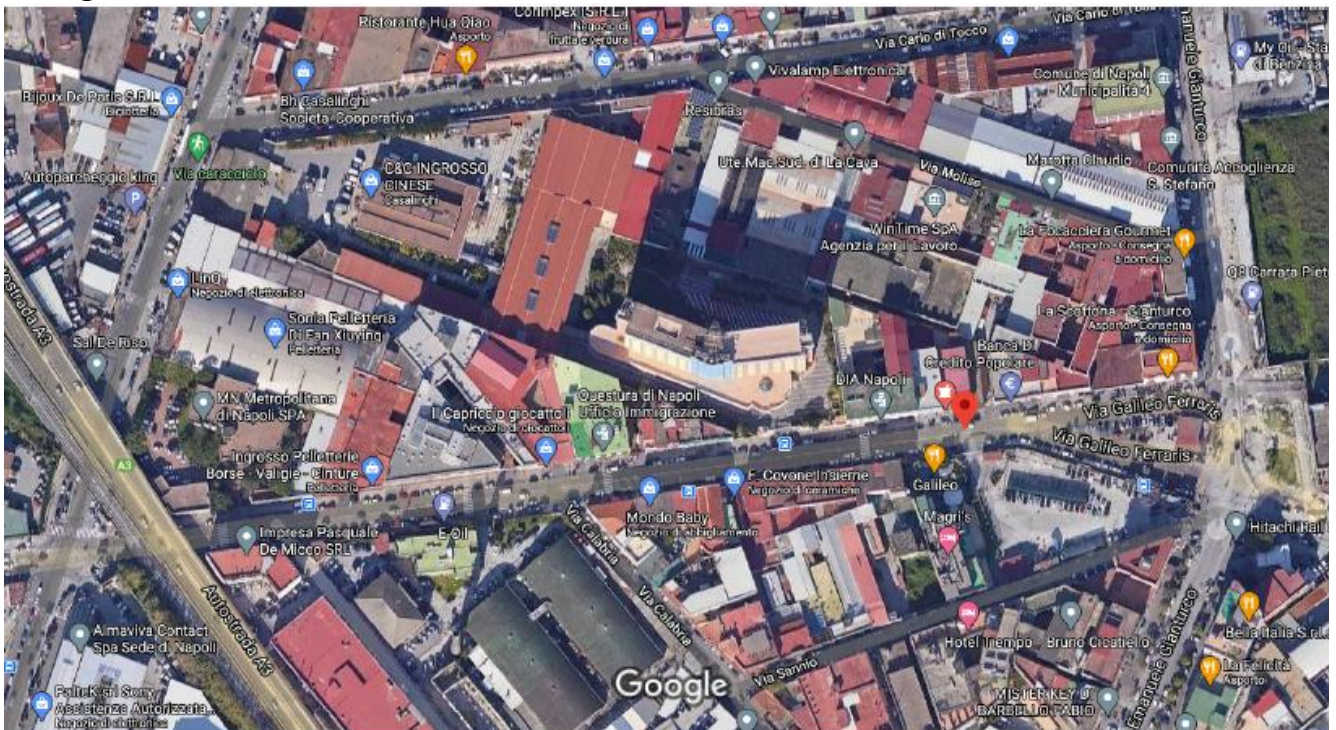





## 2.2 Geological setting

the stratigraphic structure of the area can be schematized as follows:

- from 0.0 to approx. 2.0 ÷ 3.0 m depth: heterogeneous fill soil, with sandy and gravelly granulometry
- from approx. 2.5 ÷ 3.0m at about 5.0m depth: sandy silt and silt, cohesive
- from 4.0 ÷ 5.0m to 12.0m depth: sand, subjected to a silty level

There is an exchange between the superficial and the deep aquifer with an active underground water circulation. The structure of the aquifer is very complex: the pyroclastic and sedimentary materials that constitute it present continuous granulometric variations both in the areal and vertical sense.

The consequence of the granulometric heterogeneity and the permeability characteristics of the soils present is the difficult identification of low permeability levels with sufficient continuity to divide the aquifer into several distinct layers. The pitch therefore tends to be typed in several levels, corresponding to coarse and variously interconnected materials, but always maintaining a unique character. The current subsidence, in most of the territory under examination, is less than 3-5 m from the ground level.

Contamination affects both the unsaturated and saturated phase of the subsoil.



## 2.3 Contaminants of concern

SOIL CONTAMINATION CONCENTRATIONS RANGE detected up to 6 meters deep from the ground level:

- Hydrocarbons C <12 400 mg/kg - 6500mg/kg
- Hydrocarbons C > 12 1300 mg/kg - 4600mg/kg
- Benzene 3 mg/kg - 118 mg/kg
- Ethylbenzene 100 mg/kg
- Total Xylenes 80 mg/kg - 400 mg/kg

RANGE OF CONCENTRATIONS CONTAMINATION OF GROUND WATER:

- TOTAL hydrocarbons 600 µg/l - 12000 µg/l
- Benzene 130 µg/l - 900 µg/l
- Toluene 17 µg/l - 2850 µg/l
- Ethylbenzene 100 µg/l - 330 µg/l
- Total xylenes 12 µg/l - 825 µg/l
- MTBE 50 µg/l - 6000 µg/l

## 2.4 Regulatory framework

D.Lgs. 152/2006



## 3. Pilot-scale application in field

### 3.1 Extraction system

Installation of an extraction well and a monitoring well both located within the contaminated area.

Execution of the test, with a portable system assembled for ventilation tests, consisting in:

- a Blower (aspirator) with flameproof execution side channels, being hydrocarbons, with a power of 3 KW, 50 Hz;
- a 200 L activated carbon filter for air;
- Mineral-based activated carbon for air drawn into cylinders with a high degree of activation of the type Chemviron Carbon 207E 4x8 US mesh.
- step test at different air extraction rates, for each of which the monitoring induced depression on wells, concentrations of VOC, CO<sub>2</sub> and O<sub>2</sub>, both through the wells monitoring, which exits the system.

The pilot test was conducted by inducing two different, corresponding depressions steps respectively at two different values of extracted air flow rates: the test began with a flow rate Q1 = 450 m<sup>3</sup>/h and subsequently continued with a flow rate Q2 = 350 m<sup>3</sup>/h.

### 3.3 Radius of influence

In order to calculate the radius of influence, the distance at which the vacuum is 10% of the vacuum applied to the extraction well is considered.

### 3.4 Off gas Treatment

a 200 L activated carbon filter for air: mineral-based activated carbon for air drawn into small cylinders with a high degree of activation of the Chemviron Carbon 207E 4x8 US mesh type.



### 3.5 Control parameters

A step test was carried out at different air extraction rates, for each of which the depression induced on the monitoring wells, the concentrations of VOC, CO<sub>2</sub> and O<sub>2</sub>, both through the monitoring wells, and at the outlet were evaluated. from the system.

The maximum concentration of polluting vapours extracted occurred in the first 30 minutes of the test, beyond which there was a drastic lowering of the same, up to values close to those of the natural subsoil.

With the decrease in extracted flow, a very modest increase in vapours in terms of VOC was observed, certainly not very significant.

The test was interrupted after about 8 hours due to the temporary exhaustion of the polluting load.

A good response of the system was instead obtained from the variation of the oxygen and carbon dioxide levels, which caused a decrease in O<sub>2</sub> and an increase in CO<sub>2</sub>. This data indicates a modest but continuous presence and action of indigenous microorganisms, which oxidize organic substances by consuming oxygen and producing water and carbon dioxide.

From the calculations carried out it was possible to evaluate the optimal operating flow rate equal to approximately  $Q = 400 \text{ m}^3/\text{h}$ , with a radius of influence for each ventilation shaft equal to approximately 12 m.



## 4. Full-scale application

### 4.1 Extraction system

The air extraction system (EVS) has provided for n. 3 ventilation shafts of 2 "pushed up to a depth of 3 m, and made up as described below:

- Blower (aspirator) with explosion-proof side channels (being hydrocarbons) with a power of 5.5 KW.
- "water trap" (for condensation of the extracted vapours);
- 200 litres active carbon filter for air;
- n. 3 gate valves to regulate flows and capacities;
- vacuum gauges with scales from 0 to 100 mbar and from 0 to 1000 mbar;
- PVC pipes with high decompression resistance;
- wellhead that can be inspected, with quick couplings, for measuring the gases and depressions induced on each ventilation shaft;
- connection to the blower of the wells with pipes of adequate diameter;
- all the pipes have been conveyed into a regulation barrel with valves for regulating the flows
- dilution valve before entering the blower.

### 4.3 Radius of influence

In order to calculate the radius of influence, the distance at which the vacuum is 10% of the vacuum applied to the extraction well is considered.



## 4.4 Off gas Treatment

The vapour treatment system (VOC) includes n. 1 filter containing activated carbon for air based on mineral drawn in cylinders with high degree of activation of the Chemviron Carbon 207E 4x8 US mesh type.

Below is a description with the characteristics of the activated carbon:

- Activation process = Steam;
- Density = 0.46 g/cc;
- Compacted material density = 0.50 g/cc;
- Packaging humidity = 3% by weight;
- Total specific surface (BET method) = 1100 m<sup>2</sup>/g;
- Ash content = 8% by weight;
- Hardness = 97%;
- Iodine index = 1000 mg/g;
- Carbon tetrachloride index = 60% by weight;
- Benzene index = 35% by weight;

the average concentration of volatile organic substances to be removed is about 1g/m<sup>3</sup>; the plant has a capacity of 400 m<sup>3</sup>/h, the total amount of volatile organic substances to be removed is about 400 g/h per hour. Every 100 kg of carbon have an adsorbing power of about 10 kg of organic substance. The abatement system, therefore, consisting of a 600 kg battery of activated carbon, has an autonomy of about 2 months.

## 4.5 Control parameters

<i>Control</i>	<i>Frequency</i>	<i>Parameters</i>	<i>Point of monitoring</i>
<i>Startup (7-10 days)</i>	<i>daily</i>	<i>Flow</i> <i>Extraction pressure</i> <i>Steam concentration</i>	<i>Extraction well</i> <i>Pipeing</i> <i>Emission</i>
<i>After startup</i>	<i>Every 2 weeks</i>	<i>Flow</i> <i>Extraction pressure</i> <i>Steam concentration</i>	<i>Extraction well</i> <i>Pipeing</i> <i>Emission</i>



## 6. Post treatment and/or Long Term Monitoring

### 6.1 Post treatment and/or Long Term Monitoring

In order to verify the dynamics of the remediation process and the proper functioning of the installed system, monitoring/maintenance visits are scheduled on a monthly basis, including the following works:

- General maintenance of plants and calibration of installed systems;
- Replacement and disposal, when necessary, of spent activated carbon;
- Measurement of VOC, CO<sub>2</sub> and O<sub>2</sub> leaving the ventilation system and regulation of induced depressions;
- Sampling of the incoming and outgoing air from the abatement system. Organic substances are analyzed on a quarterly basis for the entire duration of the remediation. The data is developed and processed using specialized software.

Monitoring of the soil gas, after a three-month stop of the EVS, to implement a new risk analysis three years after the start of treatment.

volatile organic substances analyzed: Benzene - Toluene - Ethylbenzene - Xylenes (BTEX), MTBE and total hydrocarbons.

Samples are taken by means of a low flow pump and adsorption on activated carbon vials

## 7. Additional information

### 7.1 Lesson learnt

In case of contamination even of the saturated one, a technology that is effective for both matrices (unsaturated and saturated) is preferable

## 1. Contact details - CASE STUDY: SVE n.12

<b>1.1 Name and Surname</b>	Daniela Fiaccavento
<b>1.2 Country/Jurisdiction</b>	ITALY-VENETO
<b>1.3 Organisation</b>	ARPAV
<b>1.4 Position</b>	Public servant, expertise in soil remediation
<b>1.5 Duties</b>	Evaluation site characterization and remediation projects
<b>1.6 Email address</b>	<a href="mailto:daniela.fiaccavento@arpa.veneto.it">daniela.fiaccavento@arpa.veneto.it</a>
<b>1.7 Phone number</b>	+39 0422 558504



## 2. Site background

### 2.1 History of the site

In July 2011, due to a road accident between a little van and a petrol tanker, 8 m<sup>3</sup> of unleaded gasoline spilled onto the road, affecting neighbouring land and some stretches of moats adjacent to the road

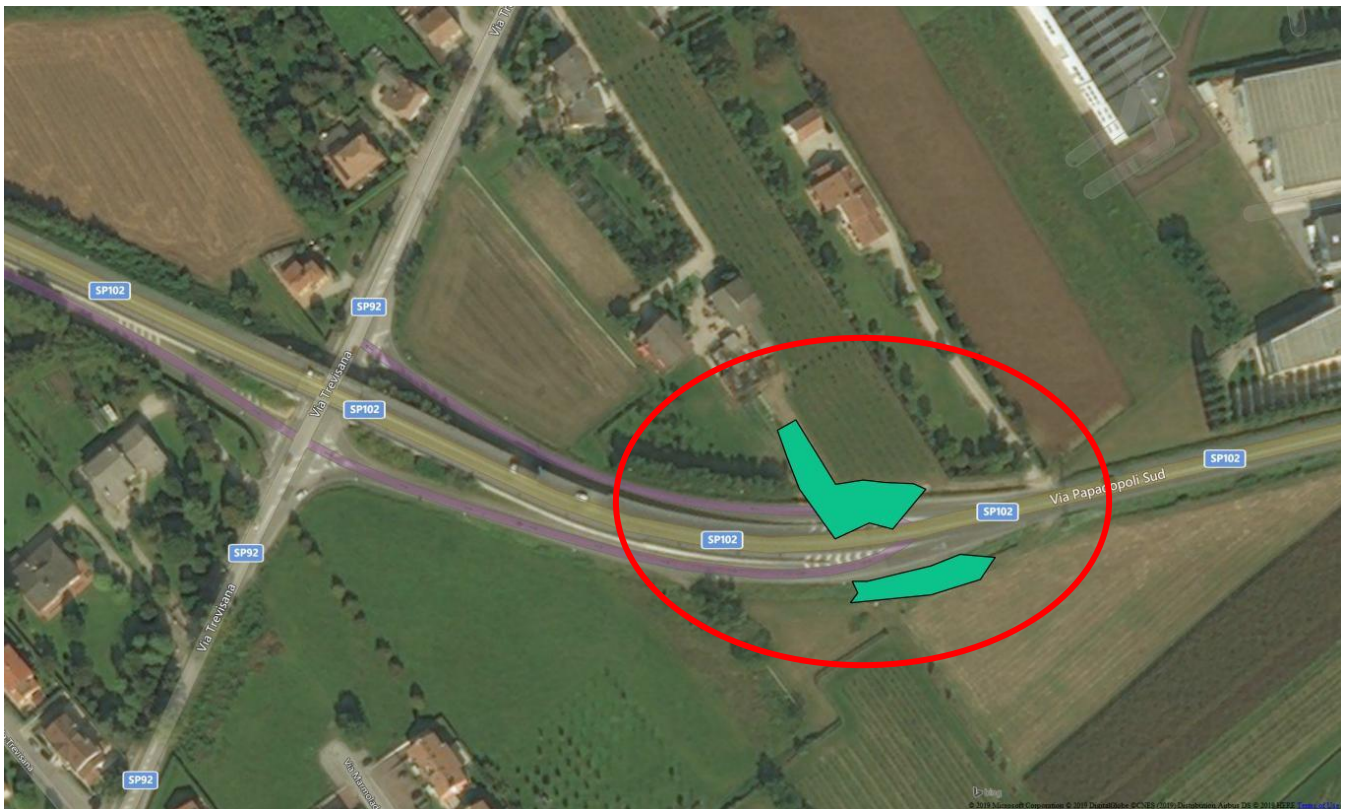

After the development of the site-specific risk analysis, the contaminated area to be remediated was that shown in the figure below. The area of contaminated soil was around 1000 square meters, 700 in the field and 300 under the road. The subsoil was contaminated up to four meters depth, only in one survey up to 5 meters.

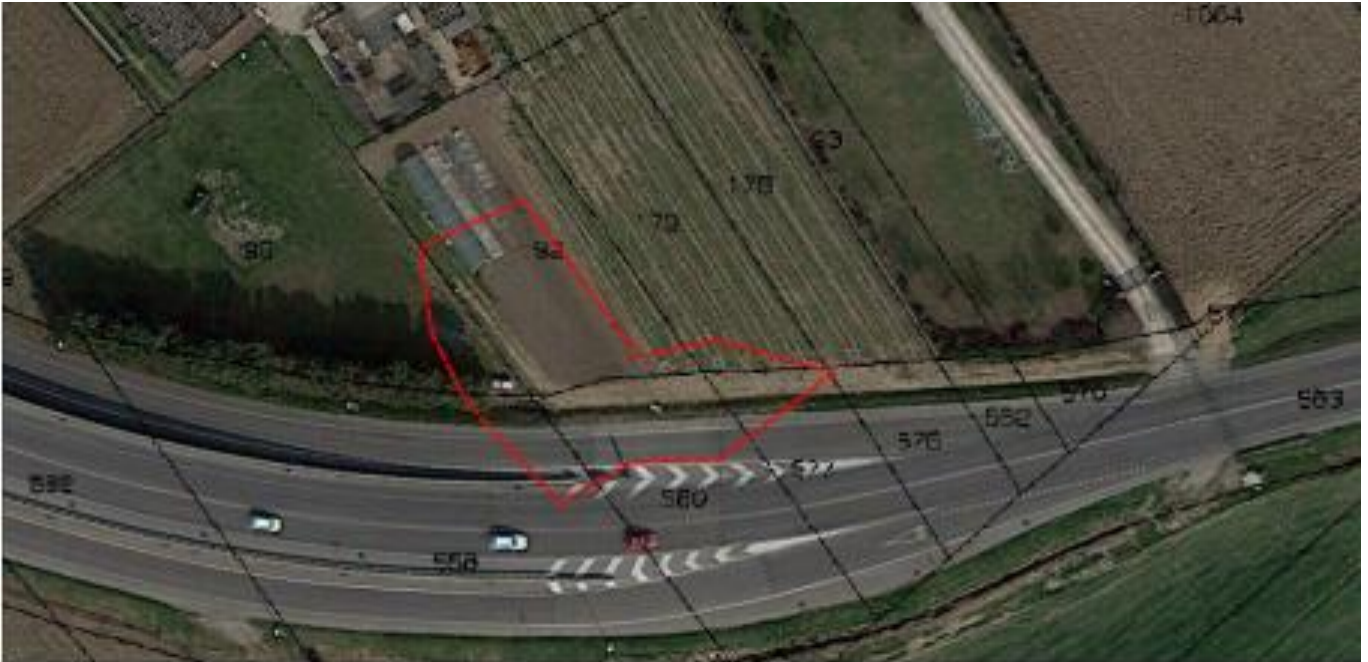

## 2.2 Geological setting

Under the first 20 centimeters of topsoil, the site presents 2/3 meters of alternation of sandy silts and silty sand and then, till 8 meters depth, fine and medium gravels in a sandy matrix.

The depth to ground water is approximately 2.5/3.0 meters below ground surface.

Below is reported the Shepard Diagram in which is collocated the types of soil of three surveys at different depth.

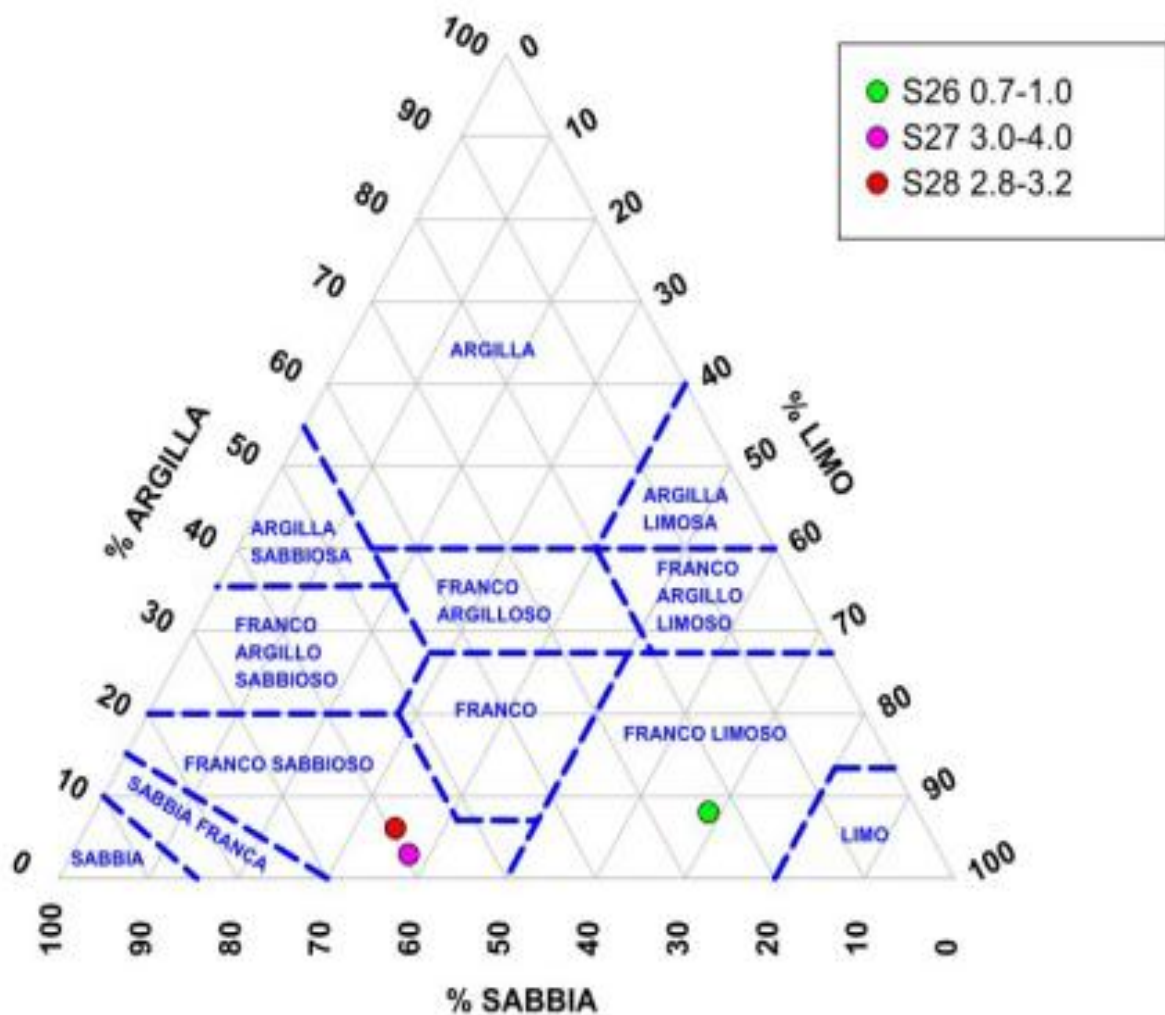

Shepard Diagram

In the figure below is reported a stratigraphy of a soil survey.

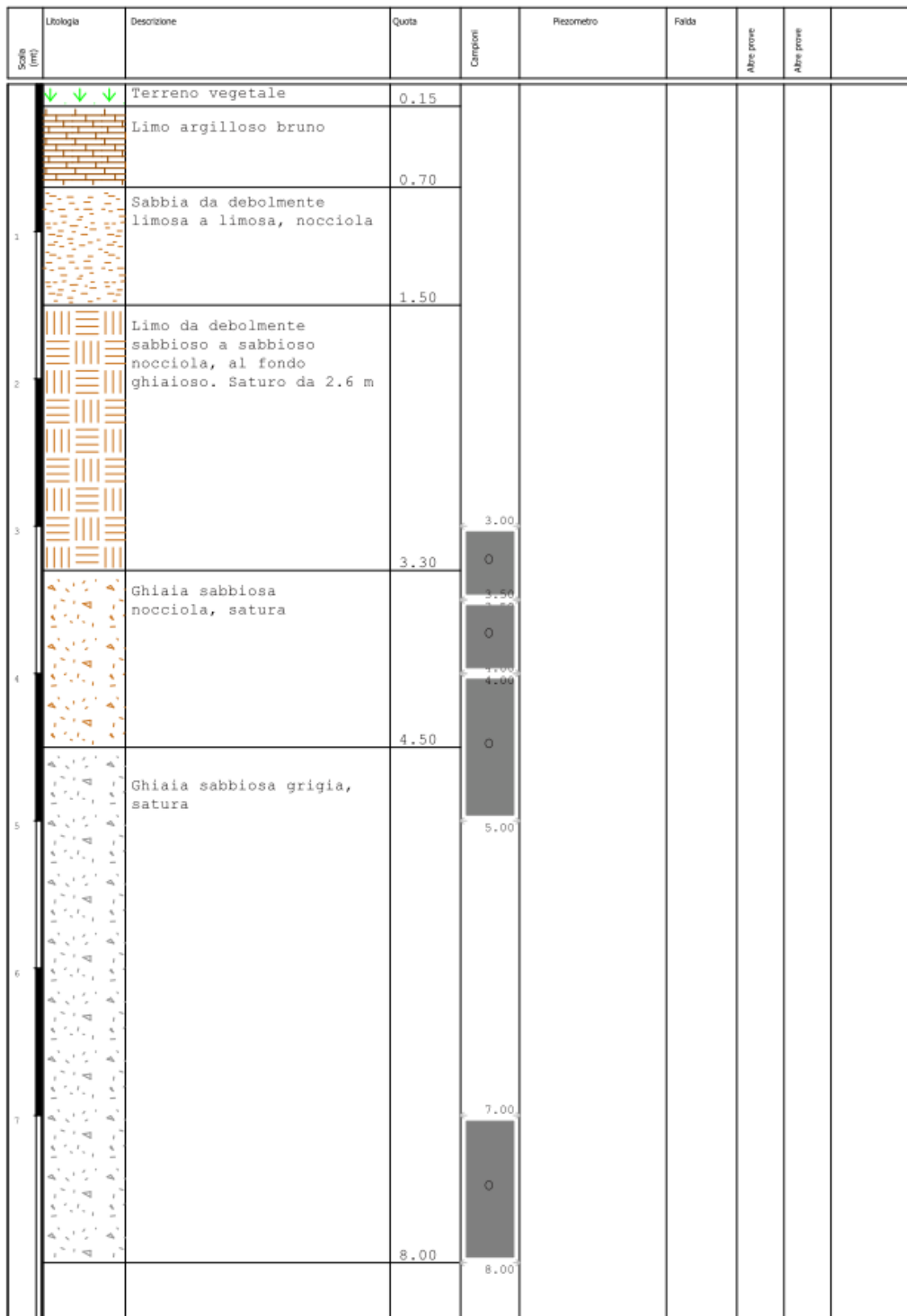

## 2.3 Contaminants of concern

Organic Compounds typical of unleaded petrol: benzene, ethylbenzene, toluene, xylene, styrene, MtBE ( methylterbutyl ether), also measured in soil gas sampling from well realized in to the subsoil.

In Italy is defined as contaminant also light hydrocarbons (C<12) and heavy Hydrocarbons (C>12), which is specified according to MADEP Method (Aliphatics C5-C8, Aliphatics C9-C12, Aromatics C9-C10 and Aromatics C11-C12 for light Hydrocarbons and Alifatics C13-C18, Alifatics C19-C36 and Aromatics C13-C22 for heavy Hydrocarbons).

In the two tables below are reported The maximum concentration, in mg/kg, for each contaminants of concern, in the surface soil (0÷1 meter deep) and in the subsoil (under 1 meter deep).

*Table 1. Max Concentration in surface soil for each CoC*

Benzene	Etilbenzene	Stirene	Toluene	Xileni	MTBE	C<12	C>12	CTOT C<>12	ALIFATICI C5-C8	ALIFATICI C9-C18	ALIFATICI C19-C36	AROMATICI C9-C10	AROMATICI C11-C22
8,1	71,0	2,3	169,0	590,0	28,0	3150,0	422,0	3180,3	1619,1	105,5	145,7	1087,7	0,0

*Table 2. Max Concentration in subsoil for each CoC*

Benzene	Etilbenzene	Stirene	Toluene	Xileni	MTBE	C<12	C>12	CTOT C<>12	ALIFATICI C5-C8	ALIFATICI C9-C18	ALIFATICI C19-C36	AROMATICI C9-C10	AROMATICI C11-C22
14,5	44,1	-	352	519	31,9	4980	37,6	5010,6	3921,4	17,5	29,8	1041,6	0,20



## 2.4 Regulatory framework

The Italian law provides for remediation of contaminated sites specific targets for urban soil and subsoil, for each contaminants of concern (CSC col. A tab. 1 All. 5 Parte Quarta Titolo V del D. Lgs. n. 152/06).

With the application of a site based risk analysis, whose results have been reported by the company in the specific document approved by the responsible Institution, it has been defined new target levels for soil.

It has been defined target concentrations for each contaminants also in soil gas, to evaluate the performance of the Soil Vapor Extraction plant.

## 3. Pilot-scale application in field

It wasn't realized a pilot scale application before the full scale plant.

Pilot test were realized after the installation of the full scale plant, before its full operation.

## 4. Full-scale application

### 4.1 Extraction system

Because of the fact that the ground water was positioned from 2.5 to 3.5 meters of depth, the project of SVE was based on a system of horizontal wells, like in the two figures above.

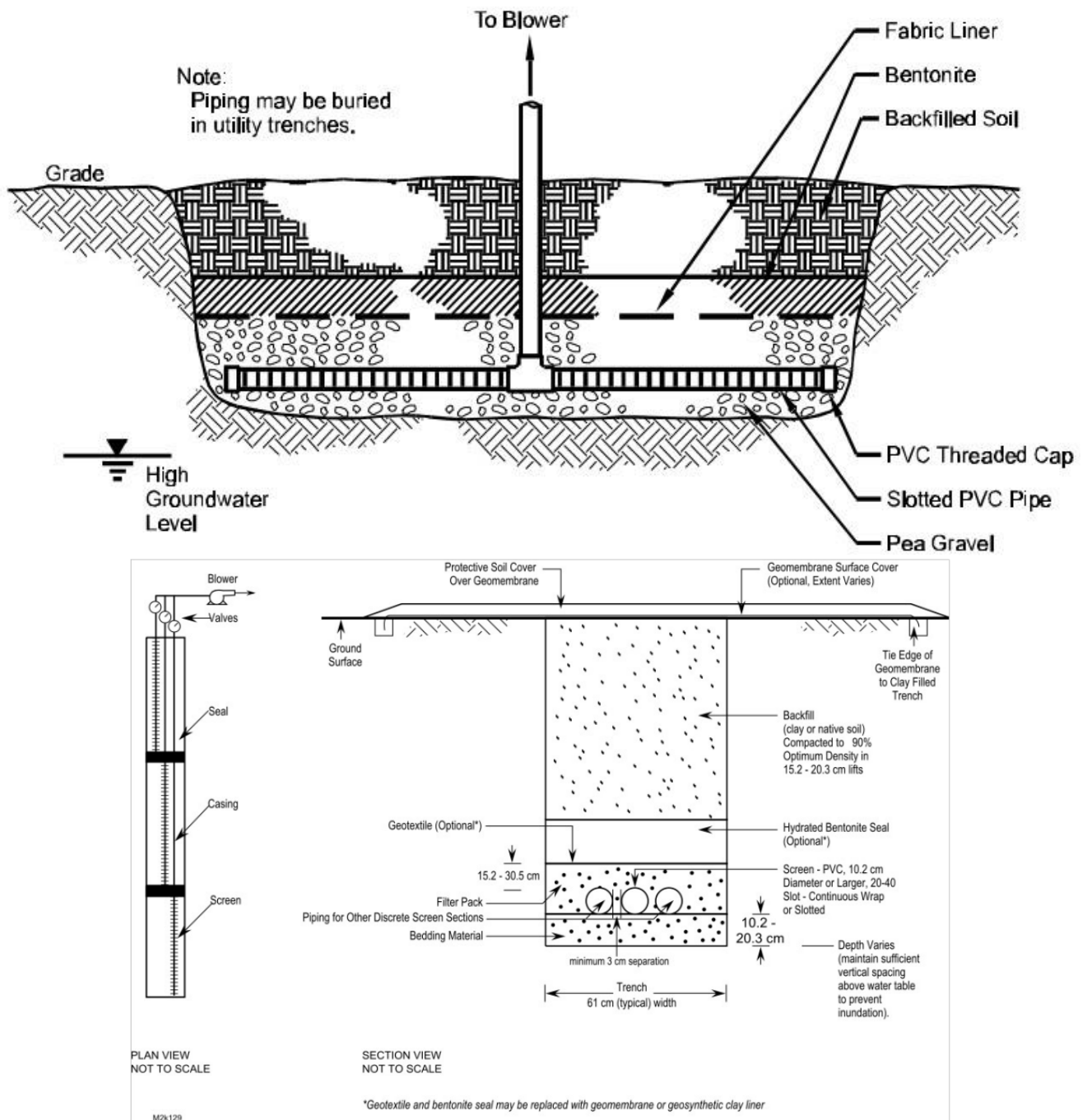

Typical construction scheme of an horizontal extraction well, view in plan and in section

(from U.S. Army Corps of Engineers, 2002)

Two horizontal lines were been made, one parallel to the road (line 1), the other orthogonal the road, forward the house (line 2), as shown in the next figure.

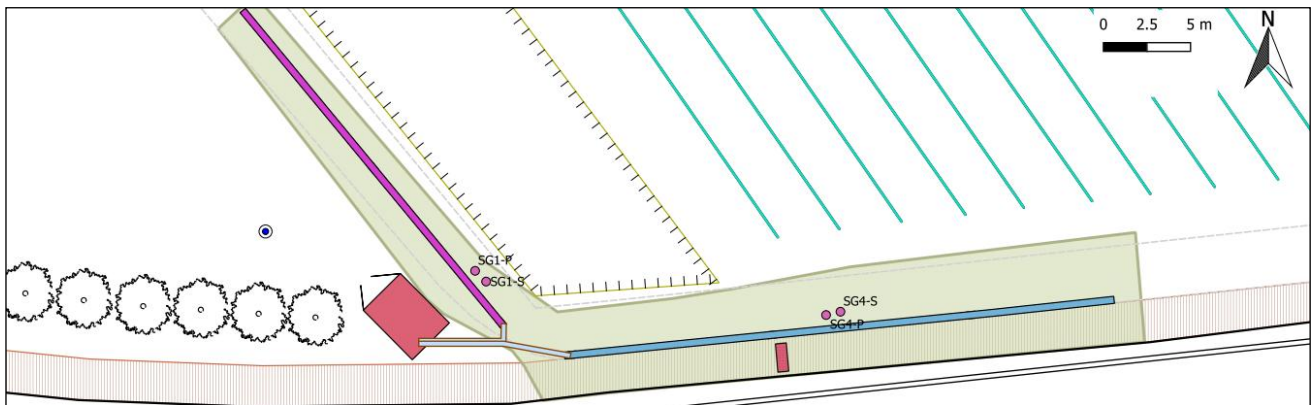

In the following table are reported the technical characteristics of the two lines of SVE

	Line 1			Line 2	
width	0.4m			0.4m	
depth	1.1m			1.3m	
length	38m			26m	
Number of sections/extraction wells	3			2	
Denomination of wells	SVE L1A	SVE L1B	SVE L1C	SVE L2A	SVE L2B
Blind section	1m	12m	24m	1m	12m
Screened section	12m	12m	12m	12m	12m



In the figure below is reported the plant scheme, which represents both extraction lines and the off-gas treatment system.

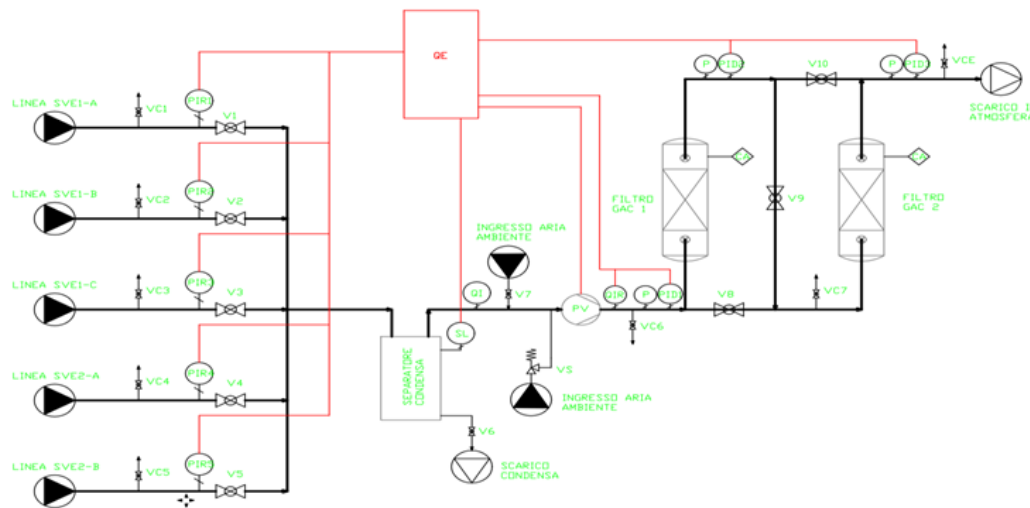

SIMBOLI	DESCRIZIONE
QE	QUADRO ELETTRICO DI ALIMENTAZIONE CONTROLLO E CAMPIONAMENTO VOC ALIMENTATO DA LINEA ELETTRICA ESTERNA.
FILTRO GAC1 E 2	COLONNA A RIEMPIMENTO CON CARBONE ATTIVO GRANULARE PER ARIA
PV	POMPA A VUOTO O ASPIRATORE
VC1 - 7	RUBINETTO CAMPIONAMENTO GAS
VCE	RUBINETTO CAMPIONAMENTO EMISSIONI IN ATMOSFERA
V1 - 10	VALVOLE DI INTERCETTAZIONE
VS	VALVOLE DI SICUREZZA
PIR1-5	MANOMETRO INDICATORE E REGISTRATORE CHE INVIA IL SEGNALE ELETTRICO AL QUADRO QE
P	MANOMETRI INDICATORI
SL	SENSORE DI LIVELLO ACQUA NEL SEPARATORE DI CONDENSATA CHE INVIA IL SEGNALE ELETTRICO AL QUADRO QE
QI	FLUSSIMETRI INDICATORE
QIR	FLUSSOSTATO INDICATORE E REGISTRATORE CHE INVIA IL SEGNALE ELETTRICO AL QUADRO QE
PID1 - 2	PUNTI DI PRELIEVO GAS PER SENSORE PID POSIZIONATO NEL QUADRO QE
CA	PUNTO DI CARICO CARBONI ATTIVI

Once extracted, the contaminated vapor was dealt to a treatment unit, based on activated carbon adsorption (see the section “off-gas treatment”)

After the beginning test (explained in the following section) SVE system started in January 2018 and was stopped before soil testing, performed in March 2019, even if the target in soil gas concentrations had already been reached in September 2018.

## 4.3 Radius of influence

The radius of influence were verified directly during the functioning of the plant through the measurement of the depression induced at the edge of the site.

The field test was realized in the following way:

1. installation of high sensitivity differential pressure sensors ( $\pm 300$  Pa) in three monitoring wells (located like in the following figure) and reset of the instrument (zero adjusted - 0 Pascal);
2. recording of basic value;
3. pump start with all 5 extraction lines open;
4. continuous recording of flow rate and depression values

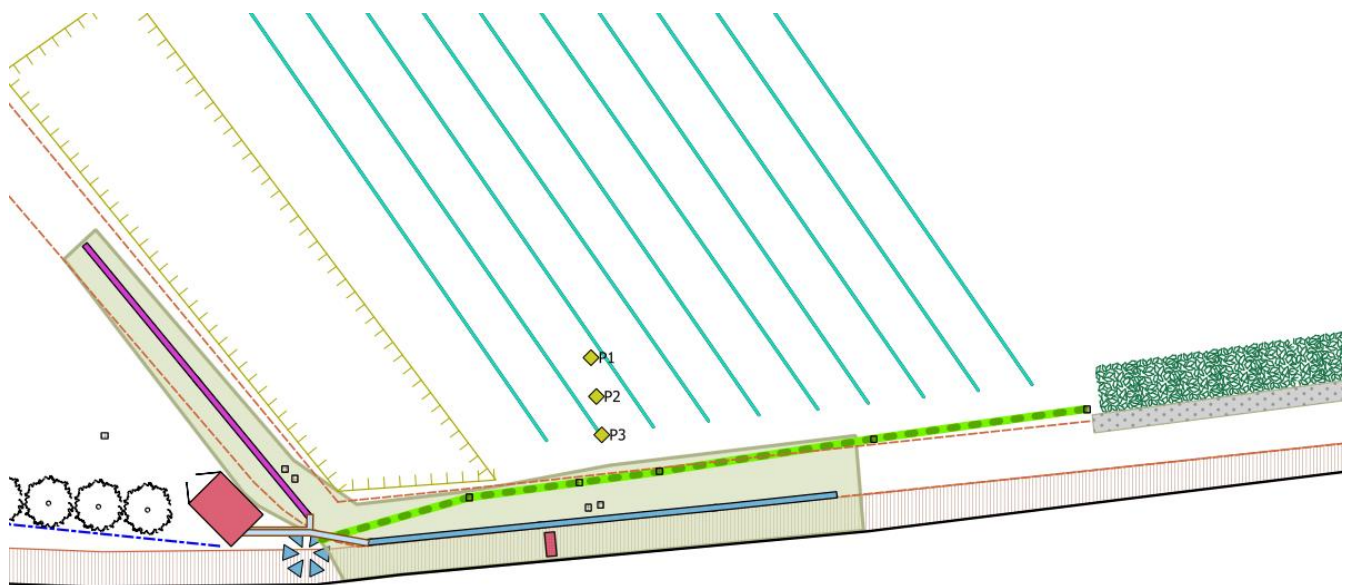

Location of pilot test wells

It was measured an appreciable induced depression, with a calculated radius of influence (6.5 m and 8.4 m) that in both cases exceeded the intervention distance, equal to 3-4 m, from the axis of extraction lines.



## 4.4 Off gas Treatment

The vapor treatment unit consists of an activated carbon unit of two modules with a capacity of 250 kg each arranged in series. The details of each module are shown below.

length plates	1.6 m
area plates	1.2 square meter
Air flow	100 mc/h
Air velocity in the filter	1.4 m/s
Contact time	1.2 s

The activated carbon will be of mineral origin, physically activated with steam. Such materials are suitable for air flows with concentrations of about 2000 ppm and have an adsorption yield of about 10%.

Yield of carbon absorption	10%
Amount of coals needed	25,600 kg
Carbon consumption rate	5.5 kg/h
Carbon filter (2+250kg)	500kg
Filter charge duration	3.8 days

In the case in point, the project data to evaluate the duration of the filters is summed below.

Media soil gas concentration	2,500 mg/mc
Extraction flow	100 mc/h
Contaminant flow	0.25 kg/h
Total amount of contaminant to be removed	1,048 kg
Filter charge duration	80 days

To achieve the target of remediation, it has been used around 2,000 kg of activated carbon.

## 4.5 Control parameters

In order to continuously monitor emissions within the legal limits provided, it has been installed a continuous control system for the measurement of VOC at the effluent discharge through a PID.

To assess the progress of the remediation, soil vapour samples were collected from four soil gas wells, located near the soil vapour extraction line; the wells were realized in couple, two surface wells (up 1 meter deep) and two wells to monitoring soil gas in the subsoil (up to 2.5 meters deep)

The following figure shows the concentrations in the wells before starting of SVE and after some months of its functioning. The concentrations are also referred to the target concentrations defined through risk based analysis (“CSR” in the figure).

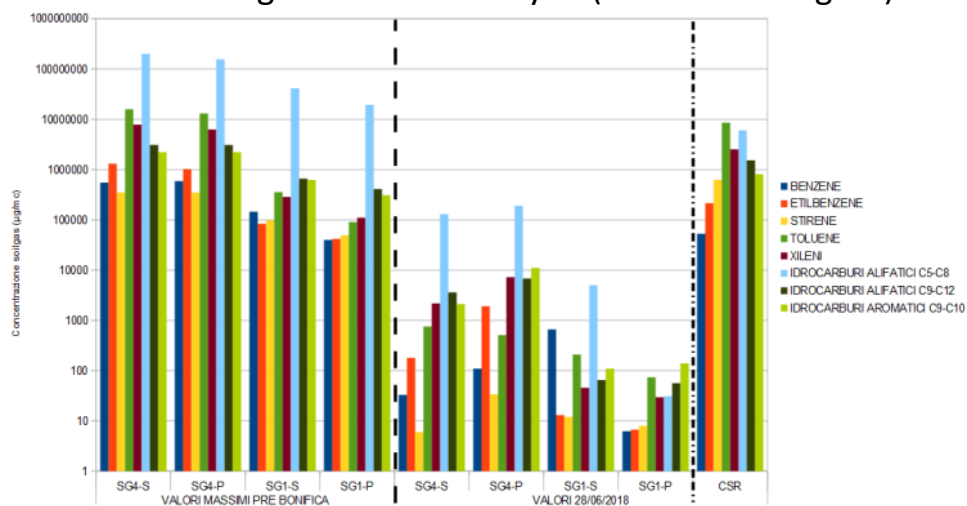

To collect soil gas sample were used steel canister or glasses bottle-vacuum (0.5 or 1 liter) with flow reduction to 50 ml/min. The soil gas chemical analysis were leaded with the MassDEP-APH 2009 method.





## 6. Post treatment and/or Long Term Monitoring

### 6.1 Post treatment and/or Long Term Monitoring

In 2018 we led two campaigns of monitoring soil gases from wells, in both cases after turning off the plant to evaluate a possible rebound effect.

Once the achievement of the soil gas target concentration had been verified, test activities on the soils were carried out, realizing four soil probes 5 meters deep. In each sample (five for each probe) it has been verified the achievement of the legal limits for each contaminant of concern.

After this test two other soil gas investigation campaigns were carried out, to confirm that the soil gas targets (concentration limits) have been reached.

## 7. Additional information

### 7.1 Lesson learnt

The case study described in this work was the first case in which it has been used a SVE extraction in fine soil (like sandy loam) and with a groundwater near the surface.

So, we found ourselves evaluating another plant solution, compared to other cases, with horizontal wells instead of the “classic” vertical wells.

In addition, unlike what the current legislation provided, reference soil gas concentrations were defined through risk analysis with the aim of assessing the progress of the remediation system.

### 7.3 Training need

I think that it would be very important to create and maintain a continuous training, not only with webinars and workshops, but also with creation of technical guidelines, and almost with training on-the job and sharing experiences with technicians from other organizations.

## 7.4 Additional remarks

In this paragraph I describe the experimentation performed in June 2017 to monitor the trend of concentration of contaminants in soil gas. This experimentation wasn't directly connected with the functioning of SVE, but it was carried out to collect more informations about the behaviour of soil gas during a certain observation period.

Going into specifics, the purpose of the experiments was:

- Evaluation of the comparability of different measurement methods
- Evaluation of the temporal variations on a sub-hourly scale of the Cov concentrations in the aeriform matrices
- Evaluation of the relationships and possible differences between surface probe and deep probe
- Possible indications of the possible perturbations induced by the sampling to the state of motion soil gas.

At the first, a high sampling frequency PID was installed in the deep probe, while the pressure differential trend was monitored in the surface probe.

A second Pid, identical to the first, was also installed for the measurement of volatile compounds in a free atmosphere. During this period, two campaign of soil gas samples were carried out, both with vacuum bottle and with dynamic flux chamber (in the figure below).



In the same period it has been installed a micrometeo control unit composed by a:

triaxial ultrasonic anemometer;

- rain gauge;
- thermohygrometer;
- differential pressure sensors

Continuous field measurements and laboratory analyzes of soil gases showed daily variability in concentrations; in addition, if the measurements are made at times favourable to the accumulation of contaminant, the detected concentrations will be higher than at other times of the day.

More details and explanation can be found at the following link

[https://www.arpae.it/dettaglio\\_documento.asp?id=7277&idlivello=1171](https://www.arpae.it/dettaglio_documento.asp?id=7277&idlivello=1171)

These experiments were carried out thanks to Copernico srl (UD), [www.copernicon.it](http://www.copernicon.it) the consulting company in the field of remediation of contaminated sites that followed the remediation activities from characterization to testing. The images, graphics and tables shown in the present questionnaire are taken from the project documents drafted by Copernico.



## 1. Contact details - CASE STUDY: SVE n.13

<b>1.1 Name and Surname</b>	Aldo Trezzi
<b>1.2 Country/Jurisdiction</b>	Italy
<b>1.3 Organisation</b>	Ramboll Italy S.r.l.
<b>1.4 Position</b>	Principal
<b>1.5 Duties</b>	Aldo has more than 25 years of experience in the management of projects related to water treatment, soil and groundwater characterization and remediation of complex sites
<b>1.6 Email address</b>	<a href="mailto:atrezzi@ramboll.com">atrezzi@ramboll.com</a>
<b>1.7 Phone number</b>	+39-335 423725





## 2. Site background

### 2.1 History of the site

Large Industrial Chemical site (more than 100 ha) active since 1901.

Actual main production: Fluorinated Compounds

Historical productions involved large use of CrVI and CHCs, mainly Chloromethanes.

The area of interest for the application of the SVE system is about 7,000 m<sup>2</sup> and is impacted by mainly Chloromethanes both in the vadose zone and in the saturated zone.

## 2.2 Geological setting

From 0 to 1-2 m bgl typically is present filling material.

From 1-2 m bgl to 18-20 m bgl the soil consists mainly of gravel with sand and silt.

The depth to ground water is approximately 9 m bgl.

The following images show the geological setting from 0 to 10 m bgl.





## 2.3 Contaminants of concern

The main compounds of concern are:

- Tetrachloromethane
- Trichloromethane
- Trichlorofluoromethane

Max concentration detected in unsaturated soil:

- Trichloromethane: 23.00 mg/kg

Regarding the unsaturated soil, the only VOC detected in the area was the Trichloromethane, with a concentration of 8.9 mg/kg in the first meter b.g.l., 6.7 mg/kg between 2 and 3 meter b.g.l. and 23 mg/kg between 4.5 and 5.5 meter b.g.l.. Italian law threshold concentration value (CSC) for Trichloromethane is 5 mg/kg, and also the risk concentration value (CSR) defined by the risk analysis for Trichloromethane is 5 mg/kg.

Max concentration detected in the groundwater (2009-2012):

- Tetrachloromethane : 170,000 µg/l
- Trichloromethane: 290,000 µg/l
- Trichlorofluoromethane: 10,000 µg/l

## 2.4 Regulatory framework

Clean-up goals for soil and groundwater were defined in the Risk Assessment, and are included in the on-going remedial plan, approved in 2012. According to Italian regulation, although the remedial targets are defined on a Risk Assessment basis inside the facility (SSTLs or CSR), groundwater quality at the end of remedial action must comply with regulatory limits (CSC, much more conservative than calculated SSTLs) at the downgradient boundary of the site. Therefore, once reduced the concentration below the CSR for inhalation risk inside the facility, the ultimate clean-up goal for groundwater is to reduce and control the off-site migration.

Nonetheless, scope of the SVE system is to remediate the unsaturated soil: reduce as much as technically possible the presence of VOCs in the soil gas and obtain concentration of the VOC compounds in the soil below the calculated risk concentrations (< CSR).

Other technologies have been applied to remediate the saturated zone.

## 3. Pilot-scale application in field

### 3.1 Extraction system

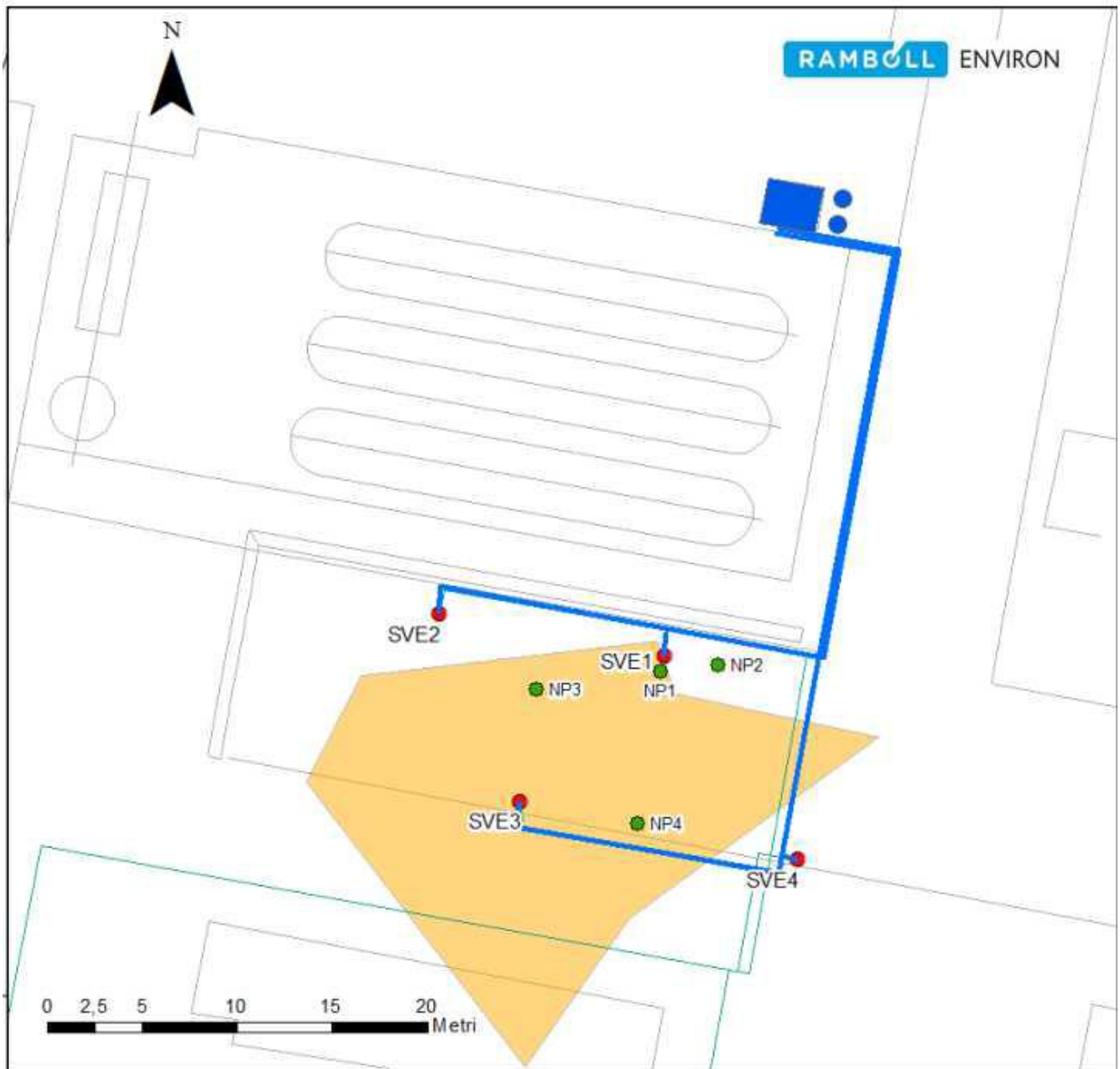

Before the installation of the full scale system, a pilot scale application was performed to estimate the effective Radius of Influence (ROI) of each extraction well, operating Flow Rate & Vacuum per each extraction point. The test system consisted in #4 SVE points (screened from 1 to 9 m bgl), # 4 Nests Probe Points (each equipped with #4 NP located

at different depths), #1 vapour/water separator tank, #2 air blowers connected in parallel (Each blower: 350 mc/h @  $\Delta P$  150÷175 mbar); #2 granular activated carbon filters connected in series (1,300 litres each) in order to remove the VOC from the vapour stream before the emission in atmosphere.

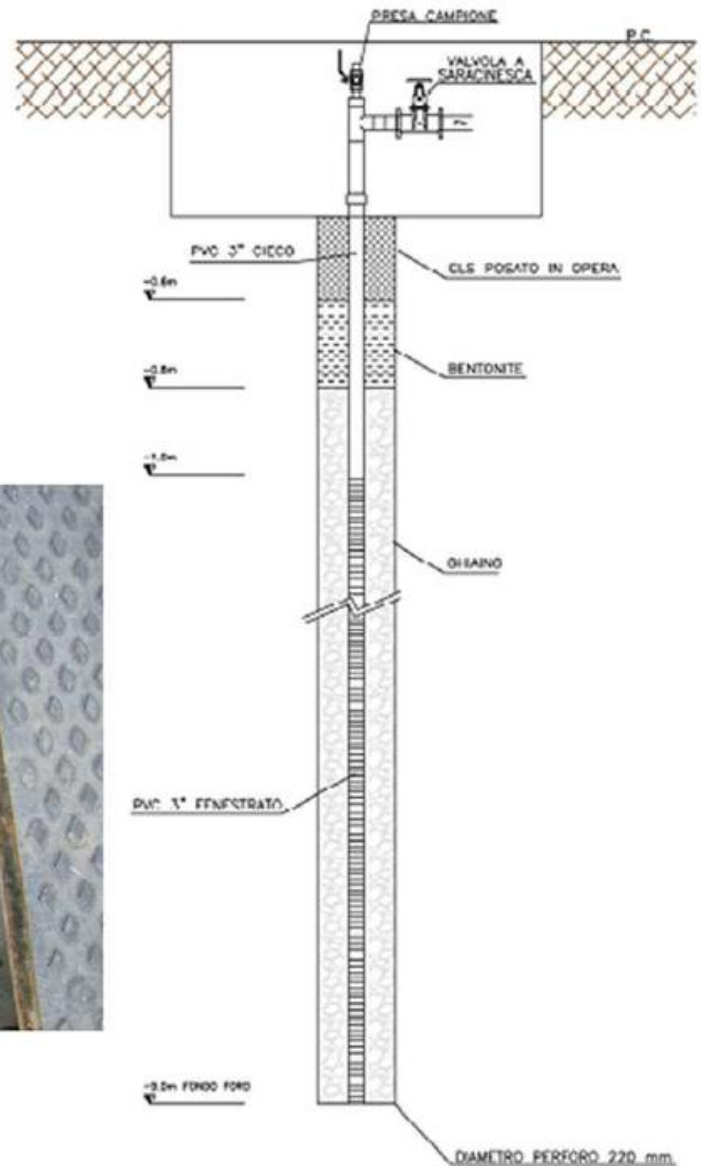

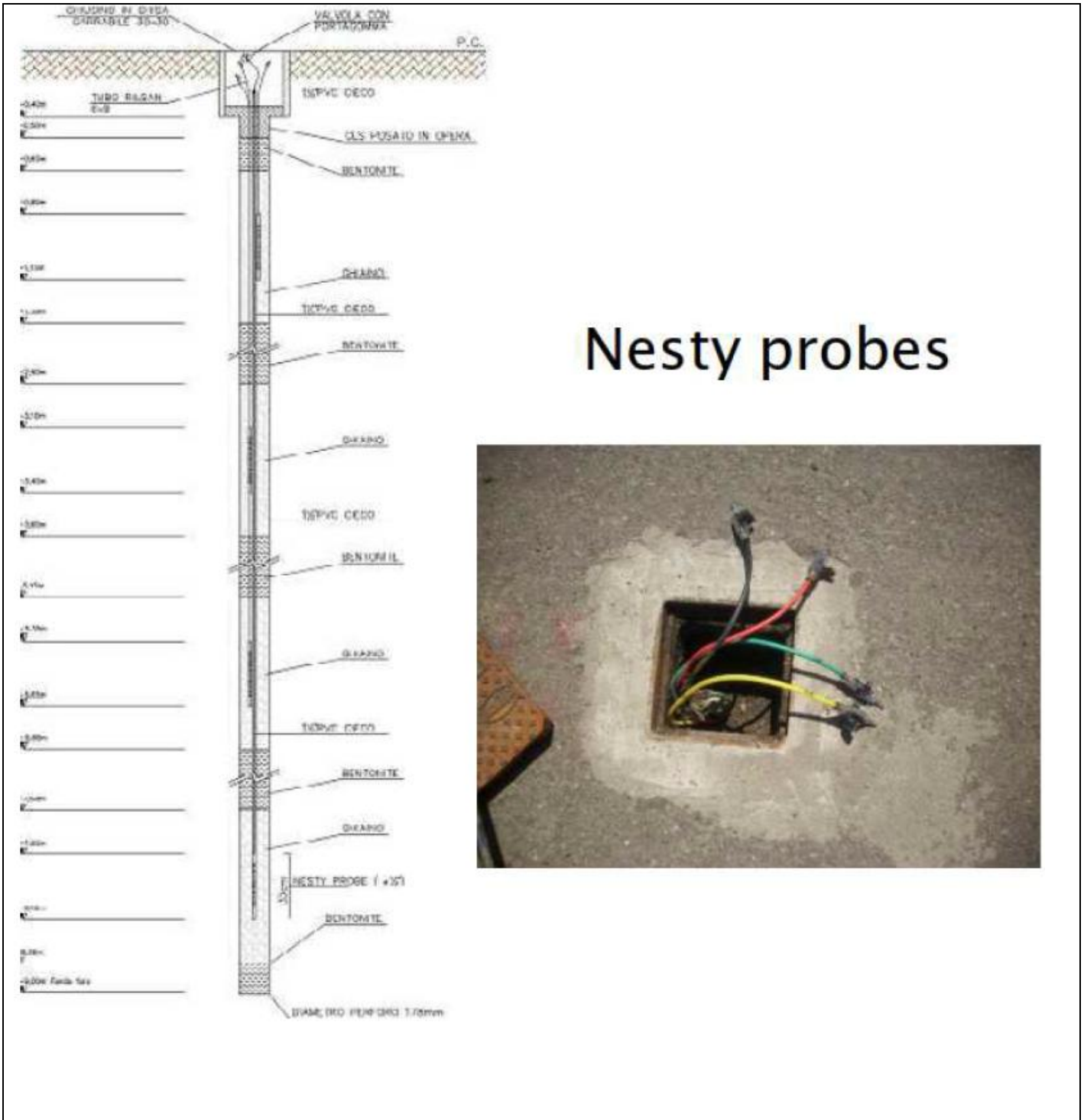

# Nesty probes



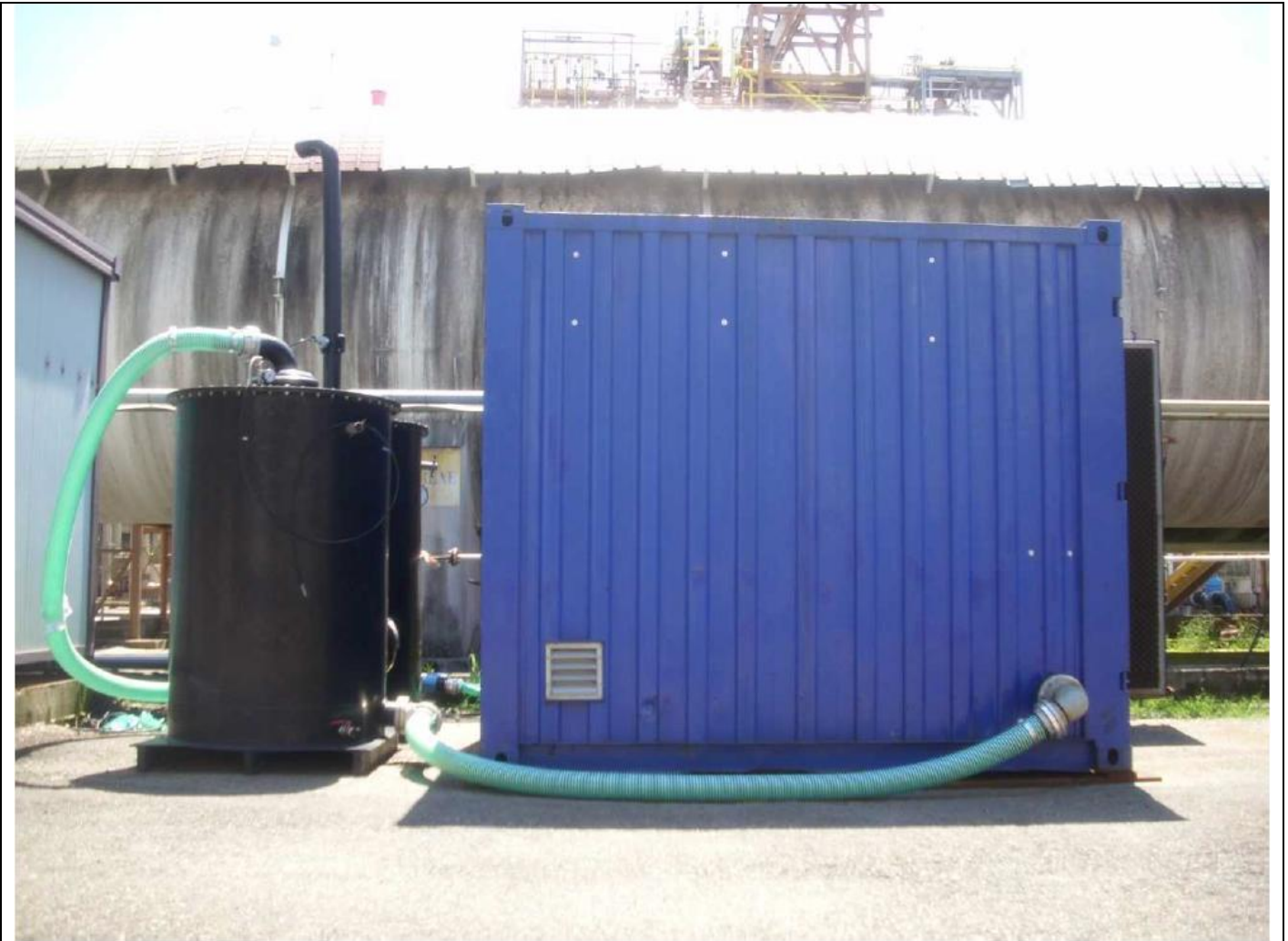

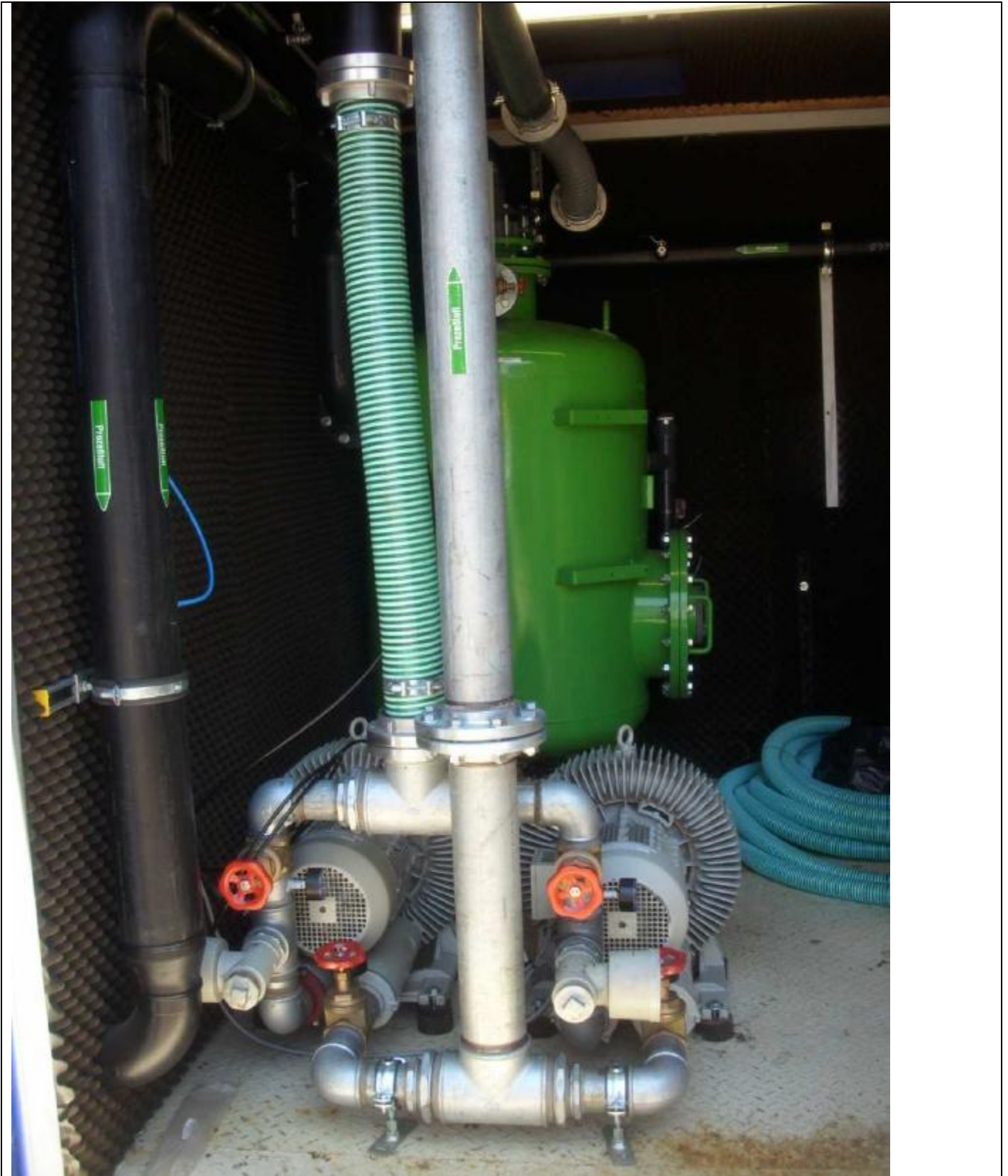



### 3.3 Radius of influence

Tests performed:

- n. 2 step vacuum test
- n. 5 long-term tests at constant vacuum

Results:

- ROI = 9 ÷ 10 m (cutoff -2.5 Pa)
- Flow rate each SVE ~ 130 mc/h
- Vacuum @ SVE head: ~ - 30 mbar

Moreover:

- n. 4 SVE points showed a good overlap of influence areas covered by each point
- granular activated carbon filters showed good removal of contaminants present in the extracted vapours

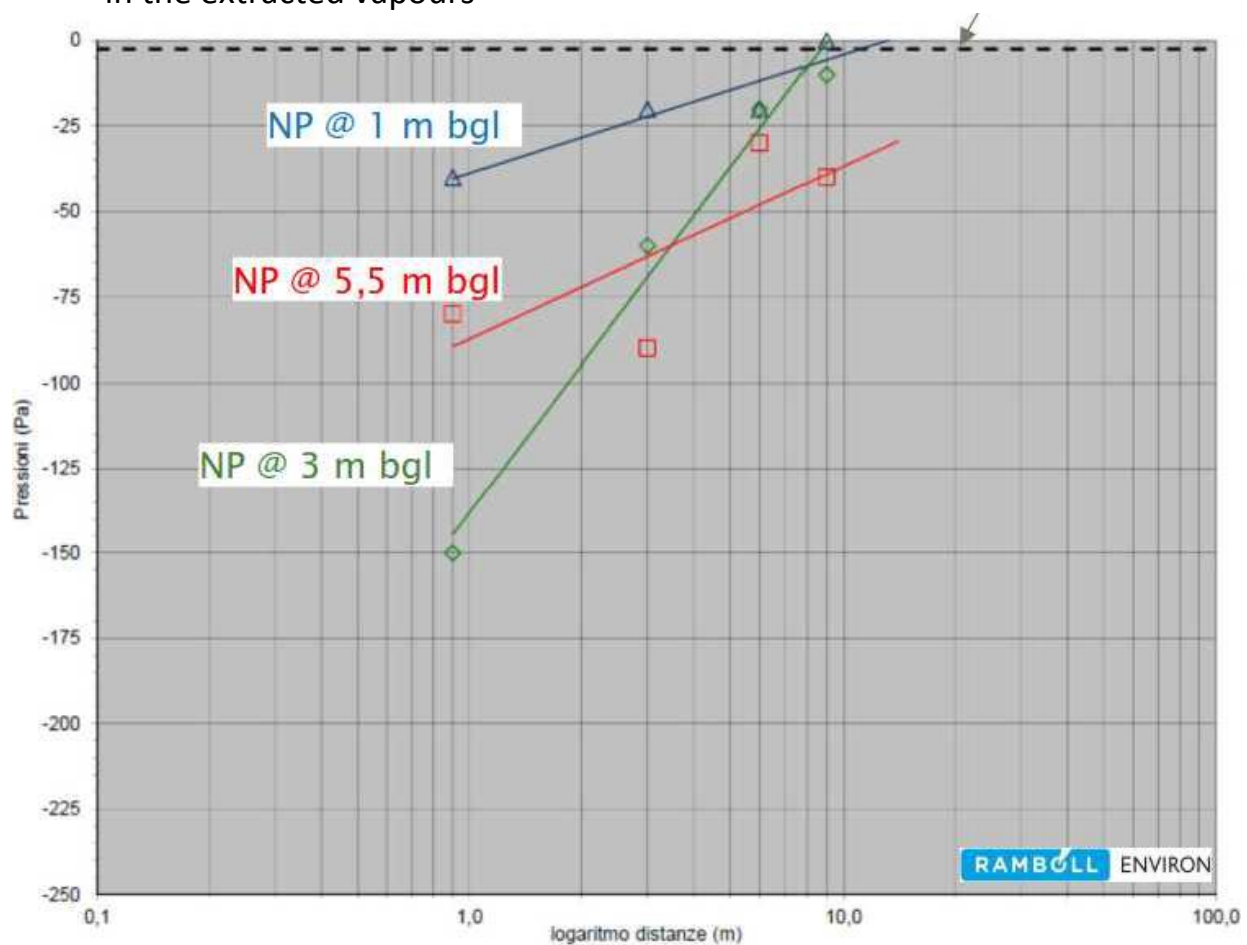



### 3.4 Off gas Treatment

During the pilot test the extracted vapours were treated by # 2 granular activated carbon filters connected in series (1,000 litres each ).

### 3.5 Control parameters

To assess the effectiveness of the treatment and evaluate the ROI, the following parameters were monitored during the pilot scale application:

- $\Delta P$  in/out blower;
- Vacuum at the wellhead of the suction point/points;
- Vacuum induced at the soil gas monitoring points (Nesty Probes) at different distances and depths from the extraction well/wells;
- Flow rate of extracted gases;
- VOC concentrations before and after treatment;
- $O_2$ ,  $CH_4$ ,  $CO_2$  monitoring at each SVE extraction and NP monitoring point before VOC sampling.

## 4. Full-scale application

### 4.1 Extraction system

The Full Scale SVE has been designed considering the Pilot Test results (ROI, flow rate per each extraction point, vacuum to be applied at each extraction point) and taking into account the whole area to be remediated:

- n. 18 SVE points;
- distance between extraction points:  $L=2(ROI) \cos 30 = 17 \text{ m}$
- Design flow rate = 2340 mc/h
- N. 4 blower (750 mc/h @  $\Delta P$  150 mbar - each)
- N. 4 Granular Activated Carbon filters (4000 l – each – 2 duty/2 standby)







### 4.3 Radius of influence

The SVE Full Scale ROI is in line with the result of the SVE Pilot Test: about 9-10 m.

### 4.4 Off gas Treatment

As for off-gas treatment, #4 Granular Activated Carbon filters (4000 l - each- 2 duty/2 duty/2standby) were installed

### 4.5 Control parameters

To assess the effectiveness of the treatment the following parameters were monitored with the following frequency

Every two days:

- Monitoring of emissions into the atmosphere with short term tubes

On a weekly basis:

- Air flow and extraction rates
- $\Delta P$  in/out blowers, vacuum induced in each SVE extraction point
- Temperature in/out blowers
- VOC analysis before vapour treatment for each blowers
- Measure of piezometric level in monitoring points present in the area

Every two weeks

- VOC analysis of the treated vapours

On a quarterly basis:

- VOC, O<sub>2</sub>, CH<sub>4</sub>, CO<sub>2</sub> and vacuum induced at each SVE extraction and NP monitoring point

After the first three years monitoring plan has been modified in agreement with Authorities, and all the activities conducted on a weekly basis until 2016 were then conducted every two weeks. The above monitoring activities allowed also to calculate the VOC mass removal



## 6. Post treatment and/or Long Term Monitoring

### 6.1 Post treatment and/or Long Term Monitoring

The long term monitoring shows the effectiveness of the remediation technology applied.

The monitoring data collected allow to calculate quite a high CHCs mass removed from the unsaturated soils and show a clear evolution (depletion) over time of the CHCs concentrations measured at the SVE points.

In fact, considering both the pilot plant (active in the period May 2011 - May 2013) and the Full Scale plant (August 2013 - January 2019), the SVE system removed about 5238 kg of CHCs:

- Tetrachloromethane: 3171 kg
- Trichloromethane: 1814 kg
- Trichlorofluoromethane: 253 kg

From the results of quarterly analyses of VOC content in the vapour extracted from the extraction points in the area of the SVE intervention, isoconcentration maps for the above mentioned three contaminants in soil gas could be drawn.

These maps show a progressive decrease in concentrations over time after starting the SVE system.

Following the achievement of the technological limit of the SVE application (asymptotic value of the extracted mass) Stop & Go tests were performed. The tests showed a negligible rebound of the concentration and consequently the SVE system was stopped and confirmatory soil samples were taken which all showed CHCs concentrations below the CSR and also the CSC values.

## 7. Additional information

### 7.1 Lesson learnt

Although the characterization surveys, performed initially by drilling boreholes, indicated only few CSC exceedances of the CHCs concentration in the soil samples, the application of the SVE system allowed to remove a high mass of VOCs. In order to properly size remediation interventions, it is therefore important to carry out a more detailed characterization of the potential contamination sources in the unsaturated soils using advanced investigation techniques such as, for example, Soil Gas Survey, Membrane Interface Probe Investigations, Passive Soil gas Survey, etc..



## 7.2 Additional information

To assess the success of the remediation it is necessary to perform:

- trend analysis of each contaminant monitored over time with respect to the initial baseline value.
- quantification of extracted VOC mass over time

## 7.3 Training need

To ensure the achievement of remediation goals it is necessary to perform a good operation and maintenance of the overall system. To do this it is important that the system is managed by trained personnel.

## Glossary of Terms

Term (alphabetical order)	Definition
VOC	Volatile organic compounds (VOCs) are organic chemicals that have a high vapour pressure at ordinary room temperature
CHCs	Chlorinated Compounds
SSTLs or CSR	Site Specific Target Level, which are named CSR in Italian regulation, are concentration target levels defined according to Risk Analysis procedure

## 1. Contact details - CASE STUDY: SVE n.14

<b>1.1 Name and Surname</b>	Ewa Szczebak
<b>1.2 Country/Jurisdiction</b>	Poland
<b>1.3 Organisation</b>	Arcadis
<b>1.4 Position</b>	Senior Environmental Specialist
<b>1.5 Duties</b>	Environmental consulting regarding soil and groundwater investigation, remediation, risk assessment. Project management.
<b>1.6 Email address</b>	<a href="mailto:ewa.szczebak@arcadis.com">ewa.szczebak@arcadis.com</a>
<b>1.7 Phone number</b>	



## 2. Site background

### 2.1 History of the site

The site is an active railway area with 4 main tracks and some crossovers. Soil and groundwater was contaminated in 2010 due to a spill of app. 800 Mg of petroleum products (mostly diesel) after a train crash. The maximum admissible concentrations for soil and groundwater are exceeded for light and heavy petroleum hydrocarbons and BTEX.



## 2.2 Geological setting

Site soil consists largely of fine and medium sands, locally overlaid by sandy loam. Uppermost soil layer is man-made fill (consisting of sandy loam with crushed bricks) and railroad ballast below the tracks. The depth to groundwater is approximately 7 meters below ground surface on the railway area and approximately 5 m bgs on the outflow.

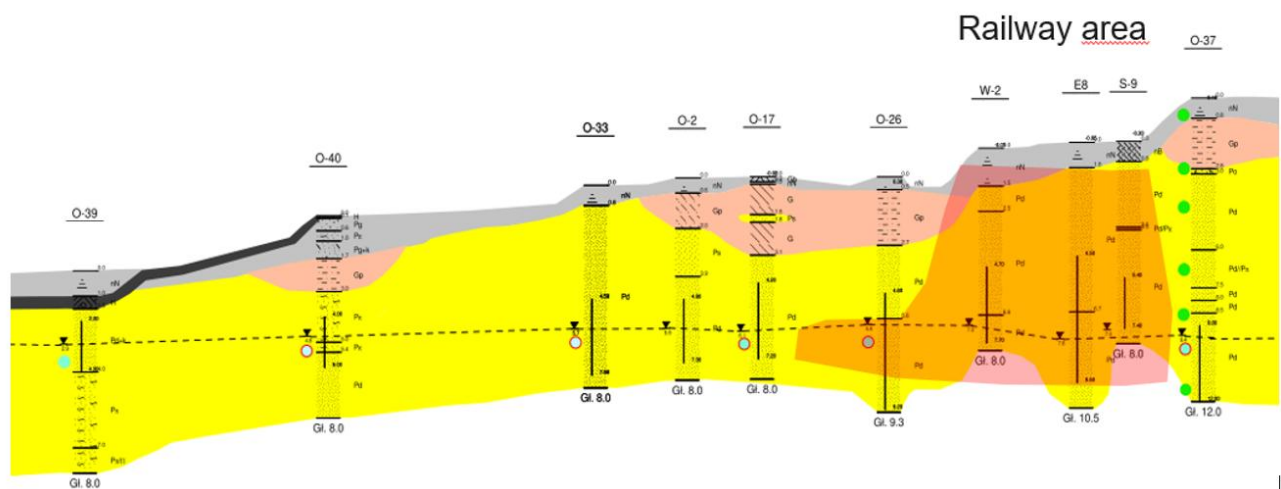

## 2.3 Contaminants of concern

The contaminants of concern detected in soil:

- Total Petroleum Hydrocarbons fraction C6-C12: BDL – 10,600 mg/kg
- Total Petroleum Hydrocarbons fraction C12-C35: BDL – 40,000 mg/kg
- Toluene: BDL – 57 mg/kg
- Ethylbenzene: BDL – 426 mg/kg
- Xylenes: BDL – 1,240 mg/kg

The contaminants of concern detected in groundwater:

- Total Petroleum Hydrocarbons fraction C6-C12: BDL – 4,990 mg/L
- Total Petroleum Hydrocarbons fraction C12-C35: BDL – 1,490 mg/L
- Benzene: BDL – 0.5 mg/L
- Toluene: BDL – 29 mg/L
- Ethylbenzene: BDL – 76 mg/L
- Xylenes: BDL – 200 mg/L



## 2.4 Regulatory framework

Due to a damage in environment after the spill of hydrocarbons the administrative procedure has been initiated. The first step was the extensive site investigation executed in a few rounds, including soil and groundwater sampling, monitoring wells installation and observation of groundwater and LNAPL behaviour. Based on the laboratory results of soil and groundwater samples, exceedances of relevant environmental standards were assessed. Remediation Action Plan was submitted to the Regional Environmental Agency, with the aim of remediation – achievement of soil and groundwater standards. After few a years of remedial system operation (LNAPL skimming enhanced with groundwater drawdown, and venting barrier on the outflow) the law in Poland has changed and the risk-based approach has been implemented. Therefore, the application for remediation based on human health and environmental risk-assessment was submitted to the Regional Environmental Agency. The proposed remedial goal is to limit the migration of contaminated groundwater.

The SVE system is a part of venting barrier, consisting of air sparging (AS) system and soil vapour extraction (SVE) system. Due to close distance between barrier and office building, the SVE system is operating to prevent potential vapour intrusion into the building.

## 3. Pilot-scale application in field

### 3.1 Extraction system

The main goal for the SVE system was to extract contaminants in the gas phase in the area of air sparging system operation. Therefore, pilot tests were carried out on the injection wells screened in the aquifer. Since the geology of vadose and saturated zone is similar (fine sand along the whole profile), the radius of influence of extraction wells was established according to AS pilot tests.



## 3.2 Injection system

One injection well and three monitoring points were installed in a line for the field test of air sparging (AS) technology. The location of the test was based on future potential venting barrier location. Distance between the injection well and monitoring points was between 1.6 and 2.5 m and it was adjusted due to the presence of underground utility lines (i.e. power line, optic fiber, sewer system). The air was injected by a blower, to a depth of 1.7 – 2.0 m below the groundwater table.

### 3.3 Radius of influence

Radius of influence (ROI) at around 5 meters was calculated for the air sparging test (air injection into one well and observations in 3 points). The observed parameters were: groundwater level and pressure versus distance. A groundwater level increase of 0.1 m was considered as the boundary of the effect of AS well. Scheme of AS test is presented below.

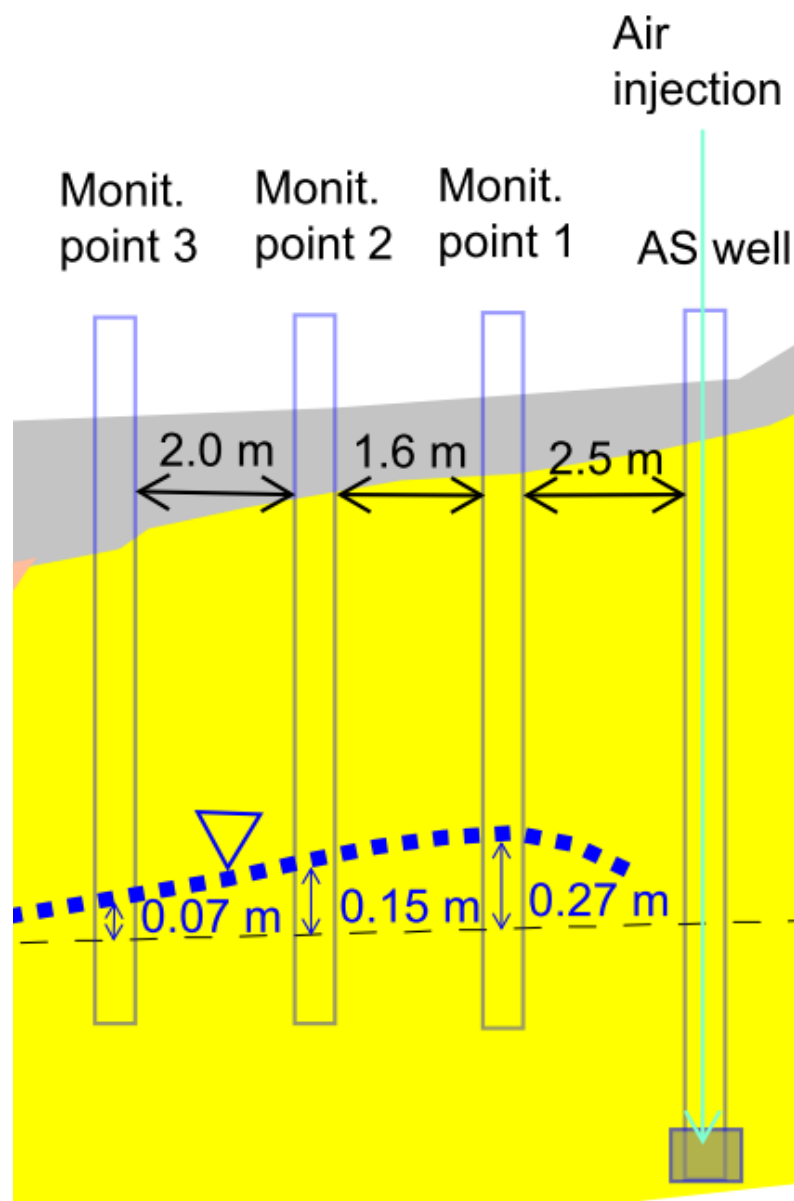



### **3.4 Off gas Treatment**

No off gas treatment was installed for the pilot test, because the test was based on air injection, not extraction.

### **3.5 Control parameters**

For the pilot scale of AS system, it was useful to monitor the oxygen concentrations in monitoring points and in surrounding GW monitoring wells. The increase of oxygen in groundwater was fast and direct proof of effectiveness of air injection.

## **4. Full-scale application**

### **4.1 Extraction system**

The SVE system includes the following equipment: a metal container measuring 3 m wide by 10 m long by 3 m high; 11 horizontal vapour extraction wells; and one air compressor. In addition, the system includes a filter with activated carbon to treat the contaminated air.

The soil vapour extraction system consists of eleven 2-inch diameter horizontal wells screened at depth of app. 4.0 – 4.2 m bgs. The wells are combined with pipelines and work as two separate lines, set between two lines of air injection wells.

The SVE system works at intervals alternately with AS system, time of each interval is half an hour.

## 4.2 Injection system

The air sparging system includes the following equipment: a metal container measuring 3 m wide by 10 m long by 3 m high; 13 horizontal air injection wells; and one blower. The AS system consists of thirteen 2-inch diameter horizontal wells screened at depth of approx. 7.0 – 8.2 m bgs. The wells are combined with pipelines and work as two separate lines, set between two lines of vapour extraction wells. The AS system works at intervals alternately with SVE system, time of each interval is half an hour.

## 4.3 Radius of influence

Radius of influence (ROI) was calculated for the air sparging test (air injection into one well and observations in 3 points) at around 5 meters. The observed parameters were: groundwater level and pressure versus distance. A groundwater level increase of 0.1 m was considered as the boundary of the effect of AS well. Scheme of AS test is presented below.

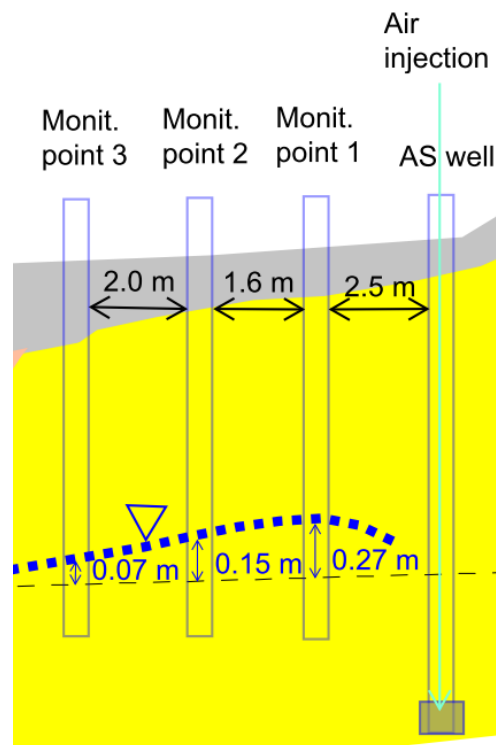



## 4.4 Off gas Treatment

Activated Carbon Adsorption is used as treatment method for off gas. A vertical filter with a capacity of 1 cubic meter is installed in the container. Granulated activated carbon is used as air emissions treatment.

## 4.5 Control parameters

- PID measurements are taken once a year in extraction points to check the effectiveness of vapour extraction.
- Periodically a PID measurements in the off-gas are taken to control the effectiveness of soil gas treatment.
- Water levels are measured regularly to control proper work of AS system.
- Contaminant concentrations and basic physical-chemical properties are measured in GW twice a year as part of groundwater monitoring programme for the site.

# 6. Post treatment and/or Long Term Monitoring

## 6.1 Post treatment and/or Long Term Monitoring

PID measurements have been taken once a year in extraction points to check the effectiveness of vapour extraction.





## 7. Additional information

### 7.1 Lesson learnt

1. **methodology and procedures:** before the installation of full-scale system, the hydrogeological data from 1-2 years of measurements (dependent on the local hydrogeology conditions) should be gathered and analyzed. It would help to avoid a situation of eventual groundwater level rise causing flow of the groundwater into extraction wells (i.e. danger of equipment damage). And for the AS system it would help to install injection wells to a reasonable and cost-effective depth.
2. **technical aspects:** the system generates a lot of heat, therefore the building where the equipment is installed should be adequately designed to decrease the indoor temperature in the summer (i.e. ventilation). Location of wells and related interdistance for the full scale system are determined also by the local conditions (i.e. underground utility lines, land accessibility). Therefore, it should be considered when designing the system to keep the proper influence area.
3. **regulatory aspects:** it would be much easier to conduct pilot studies of proposed remedial technology before the submission of Remediation Action Plan (RAP). Since after the entry into force of the new regulation, formally you should submit a RAP just after a contamination is acknowledged. Therefore, understandably, most of the clients prefers to submit the RAP before field tests. Then, if field test results show a lack of effectiveness of the proposed technology, RAP should be amended.



## 7.3 Training need

Training would be recommended both for consultants (for better understanding of the methodology and its needs) and for the authorities (for better understanding of the capabilities of SVE and the need of field tests prior the full scale system installation). Workshops and presentations about case studies are an effective learning tool.

## Glossary of Terms

<b>Term (alphabetical order)</b>	<b>Definition</b>
AS	Air Sparging
BDL	Below Detection Limit
BGS	Below Ground Surface
BTEX	Benzene, Toluene, Ethylbenzene, Xylenes
GW	Groundwater
LNAPL	Light Non-Aqueous Phase Liquid
RAP	Remedial Action Plan – an official document submitted to the authority for approval
ROI	Radius of Influence

## 1. Contact details - CASE STUDY: SVE n.15

<b>1.1 Name and Surname</b>	Puricelli Sara, Marin Rosa Angela, Ricci Diego, Confalonieri Massimiliano
<b>1.2 Country/Jurisdiction</b>	Italy
<b>1.3 Organisation</b>	ARPA Lombardia
<b>1.4 Position</b>	
<b>1.5 Duties</b>	
<b>1.6 Email address</b>	s.puricelli@arpalombardia.it m.confalonieri@arpalombardia.it
<b>1.7 Phone number</b>	+39 031 2743913



## 2. Site background

### 2.1 History of the site

The area in question is an active industrial production site that carries out engineering activities and is located in Northern Italy.

The site was divided into three portions for different distribution and characteristics of the secondary sources and managed with different remediation approaches.

Unlike the other sites managed through reductive dehalogenation processes, the one in question provided for treatment through AS/SVE for the following reasons:

- in this portion there is no natural anaerobic degradation process of the chlorinated organic compounds;
- the speed of the local water table is significantly higher than the other two source areas (at least double) and would not allow an adequate residence time of the injected substrate in the intervention area, effectively nullifying its effectiveness.

There are no specific protocols for the management of the site, but the control and technical evaluation activities in support of the Municipality (proceeding administration appointed by the Region for the management of contaminated sites) are carried out by ARPA. ARPA Lombardia is an environmental protection agency established in 1999 that deals with the prevention and protection of the environment, supporting regional and local institutions in multiple activities: from the fight against atmospheric and acoustic pollution to interventions for the protection of surface and groundwater, from monitoring electromagnetic fields to investigations on soil contamination and remediation processes.

## 2.2 Geological setting

From the hydrogeological point of view, the site is characterized by a single undifferentiated aquifer, which rests on a rocky substrate about 35 m from ground level, as shown in the section below.

The hydraulic conductivity, in the portion of the site of interest is of the order of  $3-4 \cdot 10^{-5}$  m/s, resulting in a rather high water table speed, with flow direction from West to East. The average subsidence of the aquifer is about -13 m from ground level.

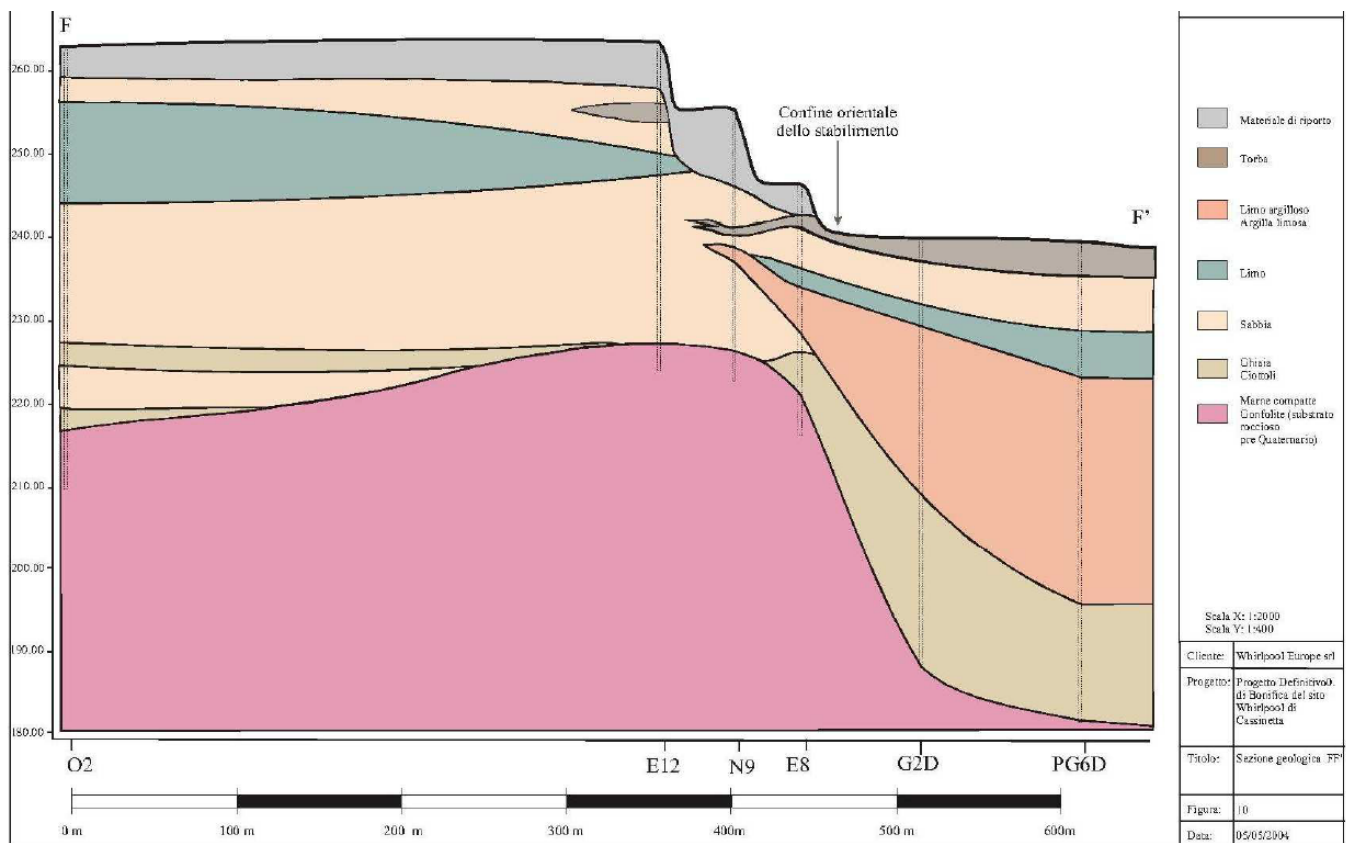



## 2.3 Contaminants of concern

Due to the production activities carried out, the groundwater was contaminated by chlorinated solvents, mainly tetrachlorethylene (PCE), trichloroethylene (TCE), 1,2-dichloropropane (DCP), cis 1,2-dichloroethene, 1,2-dichloroethane and vinyl chloride. In detail, TCE, DCP and PCE are to be considered primary pollutants, as they were actually used in the production processes of the plant during the 1960s and 1980s, while the other compounds are the products of the partial natural degradation of the previous ones.

The concentrations are very high, for some compounds in the order of mg/l. In particular, at the time of the start of the treatment in question were recorded maximum TCE values of 7.1 µg/l, DCP of 4 µg/l, PCE of 4100 µg/l and summation of organohalogen compounds of 4110 µg/l (thus demonstrating that most of the contamination is due to PCE), compared to regulatory limits for groundwater, respectively, of 1.5 µg/l, 0.15 µg/l, 1.1 µg/l and 10 µg/l for the summation.

The characteristic contaminants are essentially found in the saturated part of the subsoil, while in the unsaturated zone they were not detected in significant concentrations, thus excluding the presence of hot spot of contamination in the unsaturated zone.

## 2.4 Regulatory framework

The procedure was conducted pursuant to Legislative Decree 152/2006.



## 3. Pilot-scale application in field

### 3.1 Extraction system

The technique involved the combination of an air injection system at the bottom of the saturated area, Air Sparging (AS), and a system for extracting the vapours produced (Soil Vapour Extraction - SVE).

In detail, the first is aimed at stripping volatile contaminants present in groundwater, favouring their passage into the vapour phase and therefore their migration into the unsaturated portion of the soil, from which they are then removed thanks to the SVE system in the atmosphere following appropriate treatment.

The pilot scale tests were carried out in the period between April 2008 and June 2009, autonomously from the party without the adversary of ARPA.

### 3.2 Injection system

As in the saturated area, compressed air was injected.

### 3.3 Radius of influence

The range of influence was obtained from direct tests in the field, evaluating the depression exerted in the control wells. Support model simulations were not used.

### 3.4 Off gas Treatment

The gas treatment system is similar to that which was then implemented in the full-scale plant, described in detail in sheet 4.4.



### 3.5 Control parameters

The monitoring of the pilot plant consisted in the quantification of chlorinated compounds both in the air extracted from the SVE wells installed in the unsaturated state, and in the groundwater taken from the wells in the saturated state.

At the end of the pilot plant, quantities greater than l.q. only for TCE and PCE (expressed in mg/l) were found in waters, while the other chlorinated compounds possibly present showed negligible concentrations.

From the data found in the extracted gases it emerged that:

- the extraction of vapour phase contaminants from the SVE wells from the unsaturated soil was efficient and allowed the achievement of concentrations of chlorinated compounds in the vapours of up to  $1 \text{ g/m}^3$ ;
- the quantity of extracted contaminants is significantly greater in the deepest unsaturated wells among those used, that is, in those cracked near the capillary fringe compared to that of the more superficial wells;
- - the contaminants present in the extracted vapours essentially come from the stripping of groundwater and not from the presence of contaminants in the unsaturated zone; in fact, in the absence of compressed air injection, concentrations of contaminants were found to be considerably lower in the interstitial vapours than those detected with the AS system on.



## 4. Full-scale application

### 4.1 Extraction system

4 SVE wells were used and installed in the unsaturated domain, of which 1 was existing and 3 were installed new, headed about 1 m above the surface of the aquifer (indicatively therefore up to an altitude of 12 m) and cracked for 5 m.

Each SVE well was combined with a pair of AS wells, which were bored in the immediate vicinity of the saturated domain.

The figure shows the plan of the AS/SVE system built on the site. In it are indicated:

- in blue the wells connected to the AS plant (the PAS1S-1D pair had been used in the small-scale intervention);
- in red the wells connected to the SVE plant (SVEFT3S was used for the pilot plant);
- in green the piezometers that are planned to be used as water monitoring points.

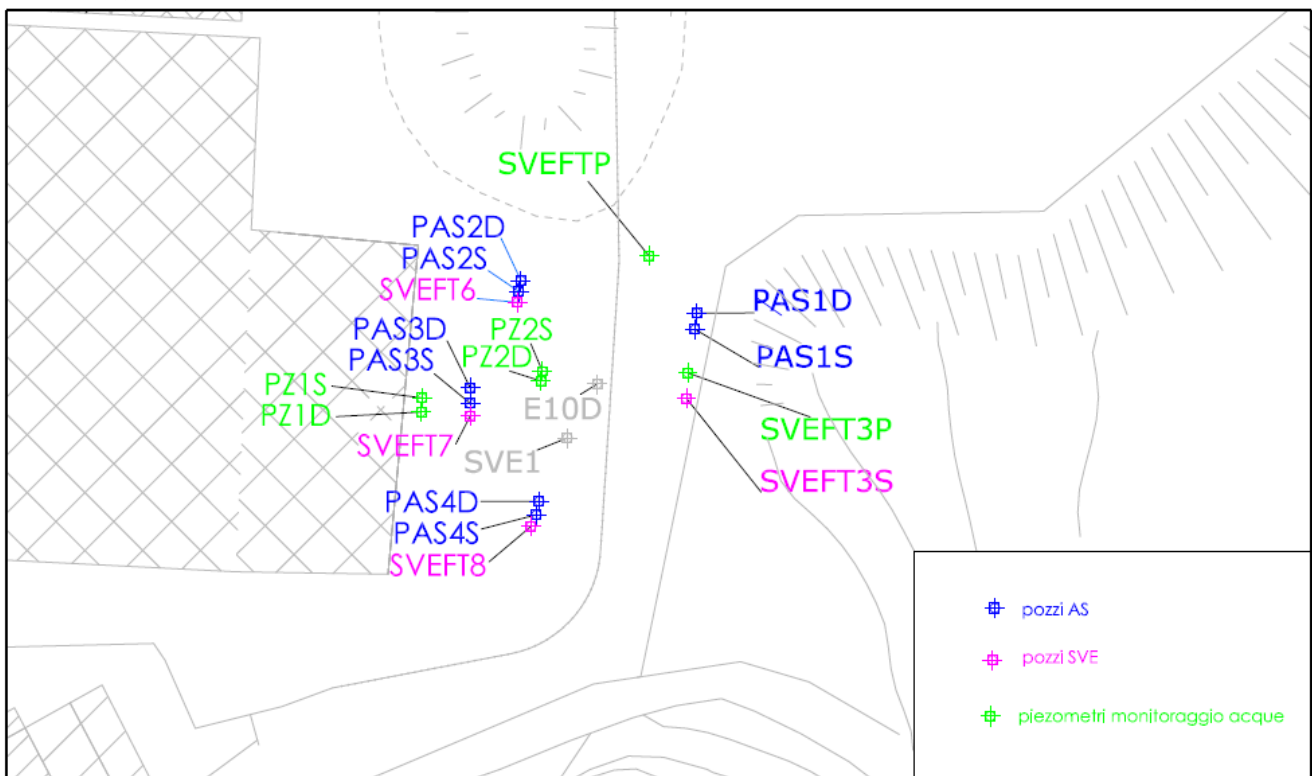

In detail, the SVE system consisted of the following components:

- 1 centrifugal aspirator with 2.5 - 3 kW power, with a flow rate of 150 Nm<sup>3</sup>/h at a depression of 120 mbar;
- 4 steam extraction pipes from as many SVE wells;
- 4 wellhead connections, designed for the measurement of air flows, depression and the taking of steam samples;
- 4 butterfly valves to control the flow rates of each suction well;



- 4 vacuum gauges;
- 4 valves for fine adjustment of the extracted flow rates;
- 1 manifold for collecting the suction pipes arriving from the wells;
- 1 dust collector filter for atmospheric air;
- 1 condensate separator, with relative booster pump;
- 1 activated carbon filter for condensate treatment;
- 2 activated carbon filters for air, connected in series and intended for the treatment of vapours;
- connection pipes, valves, various fittings, measurement and regulation sections, pneumatic quick couplings;
- command and control instrumentation (electrical panel in common with the AS system) which allowed manual or automatic operation;
- 1 container housing the entire system (shared with the AS system).

The system has been designed to guarantee a flow rate of continuously extracted vapours equal to at least double the flow rate of the air blown into the groundwater, and therefore overall capable of sucking at least 120 Nm<sup>3</sup>/h.

In the event of operating anomalies, a GSM telephone dialer was arranged who could send the error reports to specialized personnel able to restore the functionality of the system.

All quick-connect points have been prepared for taking steam samples and for inserting the following portable field instruments online:

- digital or analogical vacuum gauges for measuring depression;
- PID probes for indirect detection of VOC concentration;
- anemometers for measuring the extracted airflow.

The full-scale plant was started up in March 2013.

Here are some pictures of the AS/SVE system.





## 4.2 Injection system

4 pairs of groundwater insufflations wells (AS) were built, of which, n. 1 was existing and n. 3 were newly installed, each capable of guaranteeing the injection for 5-10 minutes of approximately 30 Nm<sup>3</sup>/h of air at an injection pressure of at least 3 bar.

Approximately, for each side-by-side, a well has a depth of 25 m from b.g.l. and the other 30-35 m from ground floor; given the nature of the compounds, with a density greater than that of water, the cracked section is located on the bottom and has a length of about 50 cm.

The AS system consisted of the following components:

- 1 rotary compressor (able to guarantee air flows of at least 70-100 Nm<sup>3</sup>/h at a pressure of 4 bar, imposing a maximum pressure of 10 bar);
- 1 storage tank for compressed air (volume 270 l), equipped with a 0-16 bar pressure gauge and safety valve for venting overpressures;
- 1 airtight compressed air delivery pipe to the distribution system, equipped with a pressure regulator (0-10 bar);
- 8 independent insufflations pipes;
- 8 wellhead connections;
- 8 analogical flow meters and 8 pressure gauges;
- 8 timed solenoid valves for air distribution in AS wells;
- 8 manual ball valves for regulating the airflow on the individual wells;
- connection pipes, valves and various fittings, measurement sections by means of float flow meters and flow regulation;
- command and control instrumentation (electrical panel in common with the SVE system);
- 1 container housing the plant (shared with the SVE system).

Downstream of the storage tank, the compressed air passed through a de-oiler filter equipped with a timed vent valve, which allowed the elimination of any oily condensate formed in the machine, preventing it from entering the groundwater.

In order to ensure the efficiency of the insufflations process, the system was set to automatically blow about 30 Nm<sup>3</sup>/h of air into a pair of wells for a duration of 5-10 minutes, while the other three pairs remained inactive.



### 4.3 Radius of influence

The range of influence was defined based on the evaluation of the pilot test.

### 4.4 Off gas Treatment

Before the final discharge into the atmosphere, the extracted vapours were subjected to purification treatment with the following characteristics:

- number of filters 2;
- total filter volume 800 l;
- quantity of GAC (granular activated carbon) 360 kg total;
- filter section 800 mm
- filtration speed 0.11 m/s
- total contact time 14.4 s.

These characteristics, established on the basis of what was verified with the pilot scale test, ensured compliance with the limits set by Legislative Decree 152/06 for each of the site-specific gaseous compounds.

The protocol provided for the replacement of spent activated carbon and its subsequent dispatch for disposal/regeneration in authorized external plants to be carried out before the reduction in the efficiency of the vapour treatment system would not allow compliance with the emission thresholds.

## 4.5 Control parameters

The monitoring plan included:

- monitoring of the vapours extracted from the SVE wells and entering/leaving the vapour treatment plant;
- periodic inspection, maintenance, and adjustment of the AS/SVE system;
- the collection and analysis of water samples, measurement of chemical-physical parameters of the water (dissolved oxygen, redox potential, pH, temperature) in 9 piezometers, available in the intervention area as well as 1 new downstream (G16) made at approximately 110 m away from the treatment area, aimed at evaluating the influence of the AS treatment on the measured solvent concentrations with respect to a blank campaign at the initial time

In fact, immediately after the start-up of the SVE plants (in March 2013) and before the start-up of the AS system, a sample of vapours was taken from each of the suction wells, analyzed for chlorinated solvents, which constituted the "blank" as not yet influenced by the simultaneous start of the insufflations of air in the saturated portion of the local subsoil. After that, the AS system was also started.

The location of the monitoring points of the 9 monitoring piezometers is visible in the following figure.

The monitoring during the execution of the intervention took place on a quarterly basis.

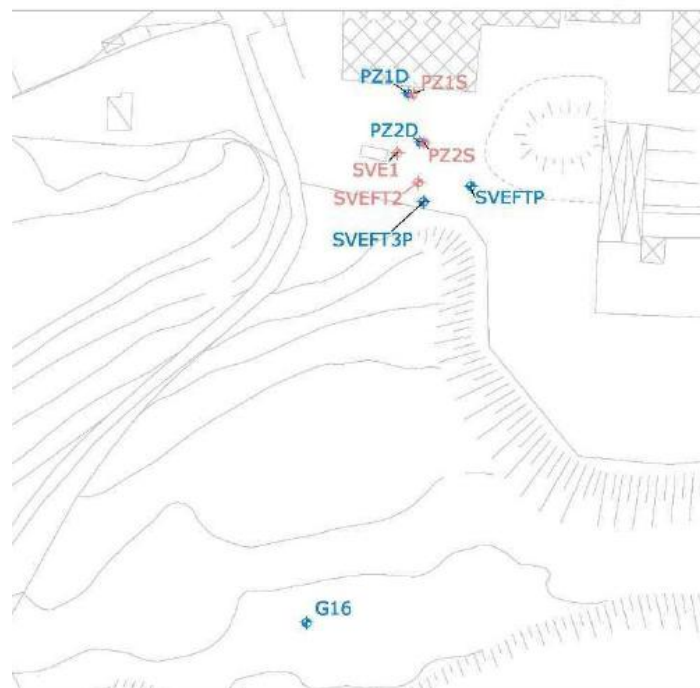



## 5. Enhancements to SVE

### **5.1 Pneumatic and/or hydraulic fracturing**

Discontinuous operating periods of the plant have been implemented, as described in § 6.1, in order to intervene on rebound phenomena and periodically evaluate the plant's cost/benefit effectiveness.



## 6. Post treatment and/or Long Term Monitoring

### 6.1 Post treatment and/or Long Term Monitoring

From the evaluation of the monitoring data, it was found that the wells from which the greatest extraction of contaminants takes place are SVEFT7 and alternatively SVEFT8. From the start of the intervention in July 2017, considering the total flow rate detected on the delivery section of the blower and the concentrations detected, it was possible to estimate the mass of contaminants extracted during the execution of the AS/SVE intervention equal to approximately 645 kg of organochlorinated solvents, consisting mostly of PCE.

On the occasion of the monitoring in July 2017 it emerged that:

- in the water taken from the piezometers of the deep portion of the aquifer, a clear reduction in the concentrations of contaminants present, up to over 90% of the initial values, and in particular of PCE and TCE, emerged;
- even in the waters taken from the piezometers of the surface portion of the aquifer, a decrease in concentrations was found even up to over 90% of the initial values;
- in the waters of the G16 piezometer, located downstream from the intervention area, fluctuating concentrations were recorded after treatment but with a decreasing trend, however with still considerable residual values. This was probably due to the considerable distance from the intervention area and the presence of a peaty horizon at a depth of about 6 m which could have limited the impregnation of the contaminants thus allowing their release over time. It was considered that it would have been necessary to wait a very long time before having an effect similar to that obtained in the intervention area. Following the concentrations detected in this piezometer, hydraulic containment was active downstream to it;
- overall, the concentration of contaminants in the extracted vapour stream decreased significantly over time, but detectable concentrations were still present in the extracted stream.

In general, from the examination of the results of the analyzes performed and the graphs that show its trend, the decrease in the concentrations of the summation of chlorinated solvents with respect to  $t_0$  emerged over time and the asymptote conditions seemed to be reached in the intervention area.

In May 2018 and up to December 2018, the AS/SVE systems were therefore shut down, and new monitoring was carried out starting from the end of the following month. There was thus an increase in concentrations in the groundwater of the intervention area, in





particular in the more superficial PZ1S and Pz2S piezometers.

It was therefore considered useful to restart the plant again for a further period of six months in order to allow further massive extraction of the contaminants present, until July 2019. The monitoring carried out following the reactivation of the plant certifies the removal of a mass of contaminants equal to 16 kg over a period of approximately 7 months.

The analytical results of the PZ1S and PZ2S piezometers show, in the period following the reactivation of the system, still significant concentrations of chlorinates in the PZ1S and PZ2S piezometers.

The AS/SVE intervention was deactivated in July 2019 and a new monitoring took place 6 months after the shutdown.

Overall, the removal of approximately 660 kg of PCE has been estimated during the operating period (2013-2020), with a decreasing trend over time.

In 2020, the authorities accepted the request to shut down the system because from the cost-benefit ratio of the treatment it emerged that it was no longer the best intervention technique at sustainable costs. This decision was reinforced by the fact that there is a hydraulic barrier at the border, and therefore an operational safety device (MISO).

The monitoring of groundwater after the works, downstream of the closure of the intervention, was prescribed on a quarterly basis until the remediation of the control piezometers provided for the area is completed, and then for another 2 years every six months.



## 7. Additional information

### 7.1 Lesson learnt

The remediation intervention allowed the removal of part of the contaminants, but did not prove decisive, as can be seen from the analysis of the analytical data on groundwater. It can be hypothesized that the specific geological and hydrogeological characteristics of the site have reduced the effectiveness of the scheme, in particular for the fine lithology of the area (peat, silt and clayey sand) and for the scarce subsidence that with seasonal fluctuations, prevented as a matter of fact the volatilization of the contaminants in the interstitial spaces of the unsaturated portion and the subsequent removal.

It could have been appropriate to undertake an evaluation of the behaviour of the plant, both for the purposes of designing it and predicting its behaviour, also to optimize its management, by means of a two-phase numerical modelling simulation, which considered the behaviour of air and water in the aquifer, evaluating the phase passage of pollutants over time and as a function of air injection/gas extraction, such as Petrasim.



## 7.2 Additional information

The Final Reclamation Project was based on a double criterion to establish the achievement of the reclamation:

a) limits in the treatment area that ensure compliance with the legal values (CSC) on the legal boundary of the site derived from the application of groundwater transport models used for the Risk Analysis. In detail, the reclamation limit concentrations were calculated using the Ogata Banks model, both for the deep aquifer and for the superficial aquifer, applying the appropriate values of the hydrogeological parameters for each, obtained through dedicated calibration.

The following table summarizes the concentrations ( $\mu\text{g/l}$ ) admissible at the end of the remediation operations.

TCE	PCE	DCP	DCE	DCA	VC
2.57	17.85	1498	42.69	29.57	2.98

b) technical remediation limit, was considered reached when the decrease in the concentrations of contaminants in the groundwater stabilized around an asymptotic value of the reduction in the concentrations of chlorinated solvents below the limit values calculated with the Ogata Banks model. In particular, following the identification of the achievement of the asymptote (verified by evaluating the analytical results of 3 subsequent samplings), provisions had been made for the suspension of the remediation activities and the subsequent execution of verification samplings on a quarterly basis and then half-yearly.



## 7.3 Training need

There is a need for specific training for more in-depth design assessments, such as the use of two-phase numerical models to design and manage an AS/SVE system adequately and in a site-specific manner.

## 7.4 Additional remarks

Here are some indications on costs:

1	Organizzazione, supervisione attività / Report finale	€	9.000,00
2	Realizzazione pozzi e piezometri	€	52.000,00
3	Installazione impianti / Demobilizzazione impianti a fine intervento	€	12.600,00
4	Gestione e monitoraggio intervento	€	47.600,00
		<b>€</b>	<b>121.200,00</b>

## Glossary of Terms

A glossary will help a you to maintain the level of precision necessary for key terms and maintain consistency across the text. We found out that sometimes terms that sounds similar like “contaminated” and “polluted” are used in the same way as synonyms in some country, while in other they have different meanings (due to legislation or for other reasons). So fill in this glossary for your key elements and of course for acronyms.

<b>Term (alphabetical order)</b>	<b>Definition</b>
AS	Air Sparging
GAC	Granular activated carbon
l.q.	Limit of quantification
MISO	Operational safety device
PID	Photoionization detector
PLC	Programmable logic controller
SVE	Soil Vapour Extraction
VOC	Volatile organic compound

## 1. Contact details - CASE STUDY: SVE n.16

<b>1.1 Name and Surname</b>	Confalonieri Massimiliano
<b>1.2 Country/Jurisdiction</b>	Italy
<b>1.3 Organisation</b>	Agenzia Regionale per la Protezione dell'Ambiente (ARPA) della Lombardia
<b>1.4 Position</b>	Dirigente RUO BARAE
<b>1.5 Duties</b>	
<b>1.6 Email address</b>	<a href="mailto:m.confalonieri@arpalombardia.it">m.confalonieri@arpalombardia.it</a>
<b>1.7 Phone number</b>	+39 335 531 8045

## 2. Site background

### 2.1 History of the site

The area in question coincides with a discontinued fuel point of sale (classified as an unhealthy 2nd class industry pursuant to the Municipal Hygiene Regulations), located along Via Lorenteggio in Milan in a city context with mixed tertiary, commercial and residential use.

The site is identified by map 18 of Sheet 505 of the NCT of the Municipality of Milan.

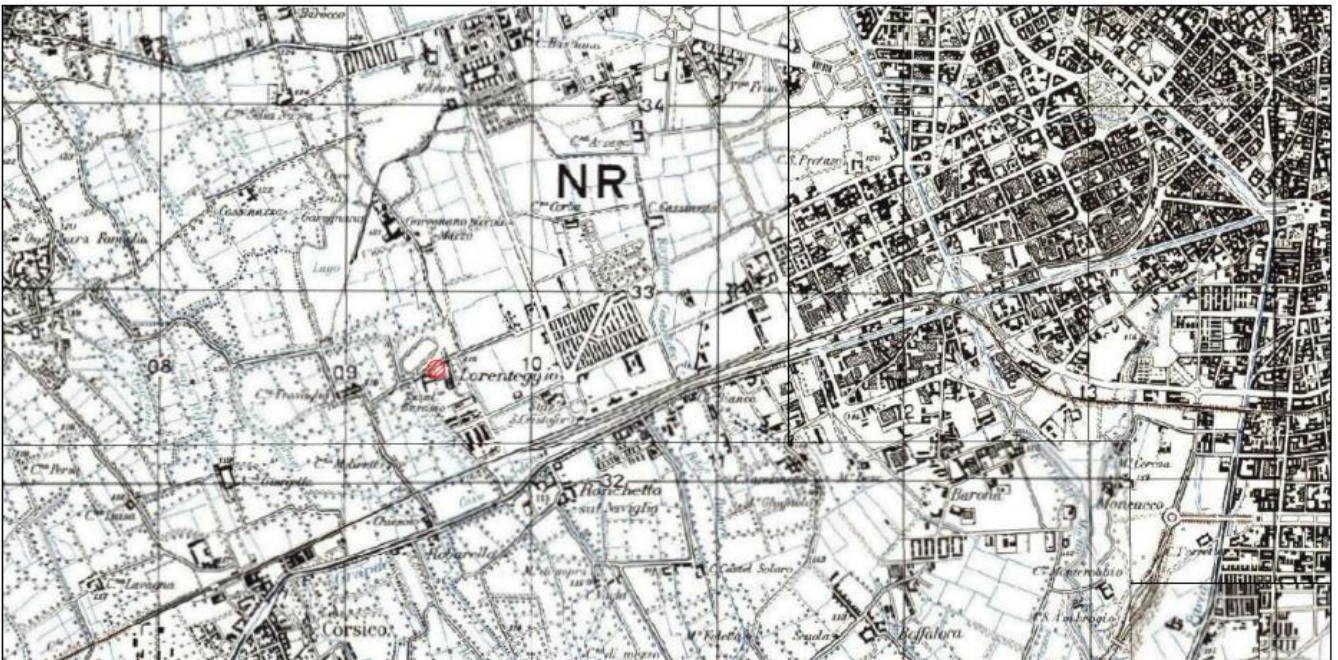

The site does not fall within the perimeter of a SIN and is not affected by any protocols stipulated with the PA.

The plant was located in an area owned by a third party, used with a lease agreement and with the obligation to return it to the owner upon definitive cessation of the activity.

Currently, after the characterization and implementation of the remediation work (not yet completed), the site - after being returned to the property owner- looks like an entirely asphalted area equipped with a public car park at ground level.

The commercial settlement in question, following the temporary cessation of the sale of fuels requested by the managing oil company (with a note dated 03/24/2011) approved by the Municipality of Milan (with note prot. 266874/2011 of the Ufficio Carburanti del Settore Attuazione Mobilità e Trasporti), ceased all activities in 2011.

The site was therefore subject to cleaning and inerting the tank fleet, with interventions



carried out in April 2011.

Subsequently, in application of municipal regulations, the site was the subject of a preliminary environmental investigation campaign carried out in conjunction with ARPA. The results of this preliminary environmental check have shown that the reference CSCs have been exceeded and initiated the procedure pursuant to Title V, which saw the presentation, approval and execution of the Characterization Plan as a first step.

## 2.2 Geological setting

The stratigraphy of the site reconstructed with the surveys delineates a soil of mainly sandy matrix. In detail, the lithological sequence found can be summarized as follows:

- mixed material - Mixed material, essentially consisting of medium sand with the presence of gravel and pebbles that extends from 0 m from ground level about 2 m from ground level;
- silty sand and sand with gravel - fluvioglacial alluvial deposit consisting of alternating levels of silty sand and sand with gravel, extending from 2 m from ground level to 16 m from ground level.

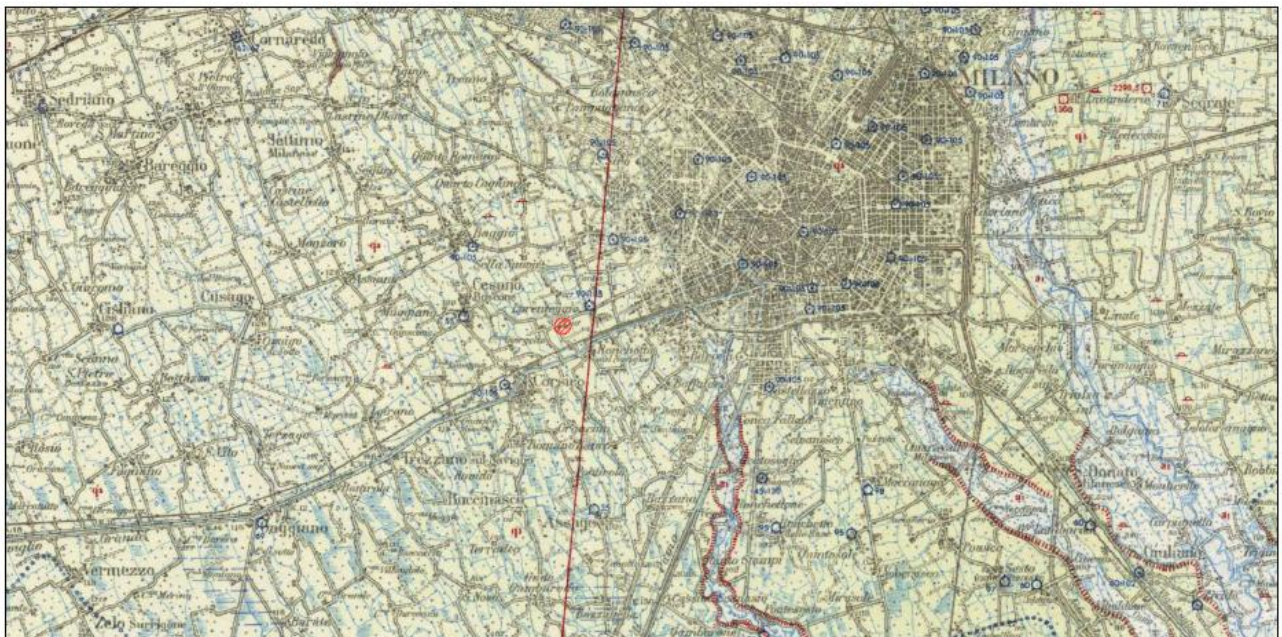

The environmental characterization survey carried out made it possible to identify a free aquifer with high permeability, contained within the alluvial deposit with gravels. The measurements of the piezometric levels performed during the characterization phase indicate an average groundwater depth of about 8.00 m from the p.c., i.e. a water table level that is around 109 m a.s.l.

Over time, the phreatometric checks carried out during the groundwater monitoring campaigns have highlighted the persistence of constant conditions in the direction of flow and periodic variations in the subsidence in a range of about 2 m.

The level measurements, together with the data deriving from the altimetry survey,



made it possible to reconstruct during the characterization phase the trend of the water table, which shows a prevailing flow direction towards ESE and an average hydraulic gradient of approximately 0.16 %.

The direction of flow of the water table was always confirmed by the phreatometric data acquired during the monitoring carried out on the site.

The average transmissivity of the aquifer calculated on the basis of the Pilot Tests described below equals to  $0.1 \text{ m}^2/\text{sec}$ .

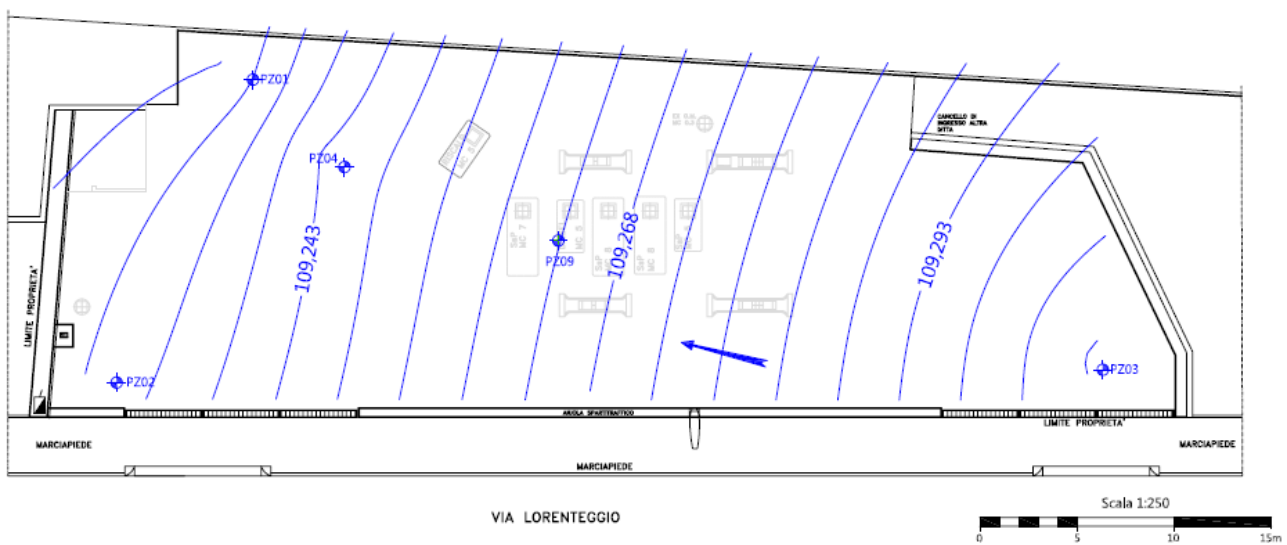

The contamination detected was in the deep soil (SP), starting from the level of the basement level of the underground tanks (about 4 - 5 m from the local p.c.); the local water table was also contaminated.

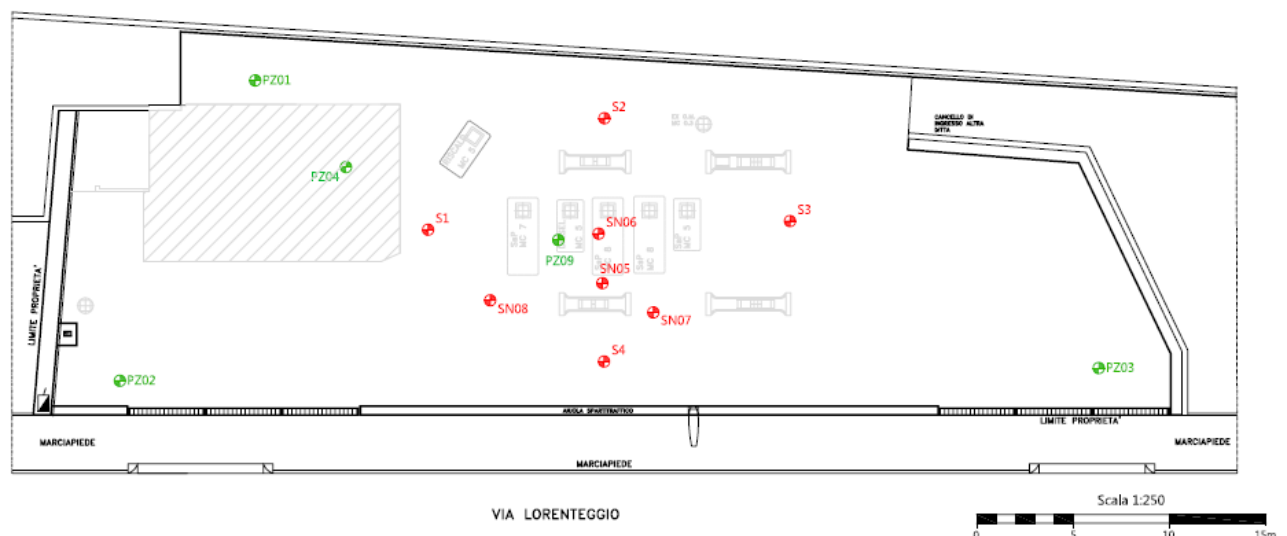



## 2.3 Contaminants of concern

The preliminary environmental investigation phase (IA), carried out at the same time as the removal of the tank park, concerned: walls and bottom of the excavation resulting in the removal of existing tanks on site, bottom of the resulting excavation after the removal of a small tank for the storage of used oils.

Analytical tests were carried out on the samples taken, aimed at determining the concentration values of heavy and light hydrocarbons (C <12 and C 12 - 40), IPA, BTEXS, Pb and MTBE.

The results of the analytical assessments were compared with the acceptability limits (CSC) set by current legislation (in particular table 1, column A of annex 5 to title V of part IV of Legislative Decree 152/06 and subsequent amendments and additions, considering that the area in question will be returned to the property once the decommissioning of the PV is completed) for the quality of the soil/subsoil matrix with respect to possible contamination.

The results of the control analyzes carried out by ARPA showed the presence of exceedances of the CSCs in particular for petroleum hydrocarbons (C > 12).

This evidence led to the continuation of the proceedings pursuant to Title V of Part IV of Legislative Decree 152/06, the communication of which was made in advance by the obliged party pursuant to art. 249 of the same Legislative Decree 152/06.

The site was therefore the subject of a Characterization Plan assessed and approved during the dedicated Services Conference and subsequently authorized by the Municipality of Milan with the PG 790255/2012 deed of 04/12/2012.

The results of the characterization showed that the reference CSCs were exceeded (col. A of Tab. 1 of annex 5 to Title V of part IV of Legislative Decree 152/06) for parameters C <12, C > 12, BTEXS (benzene, toluene, xylenes, ethylbenzene) in the unsaturated soil matrix and for the parameters (Tab. 2 of Annex 5 to Title V of Part IV of Legislative Decree 152/06) total hydrocarbons n-hexane, benzene, xylenes in addition to MtBE and EtBE (with reference to the values indicated by ISS, used at the time, not being regulated at that date) for the local groundwater matrix.

Pending the continuation of the procedure, an intervention by MISE was activated, implemented through a system for the extraction of water from the local groundwater (the discharged water was initially collected and disposed of as liquid waste, awaiting authorization from the competent authority to discharge it into the public sewer system).

The obliged subject therefore presented (pursuant to Article 242 and following, as



Ministerial Decree 32/2015 was not yet in force) a risk analysis report and related remediation project to be implemented with the simultaneous intervention on the groundwater matrix (by P&T) and on unsaturated soil/subsoil (by SVE and AS). The risk analysis and remediation interventions were evaluated and approved in the Services Conference and then authorized by the Municipality of Milan.

## 2.4 Regulatory framework

- “Linee Guida Serbatoi Interrati” ARPA - Lombardy, Milan - April 2004;
- Law 9 December 1998, n. 426;
- Legislative Decree 11 February 1998, n. 32;
- Legislative Decree 3 April 2006, n. 152 "Norme in materia ambientale";
- Legislative Decree 16 January 2008, n. 4 “Ulteriori disposizioni correttive ed integrative del decreto legislativo 3 aprile 2006, n. 152 ”;
- Law 28 January 2009, n. 2;
- Legislative Decree 3 December 2010, n. 205";
- Law 9 August 2013 n. 98;
- DM 31/2015
- D.G.R. Lombardy 10 February 2010 n. 8/11348;
- ISPRA (formerly APAT), October 2010 "Protocollo ISPRA-INAIL (ex-ISPEL) per la valutazione del rischio associato all’inalazione di vapori e polveri, in ambienti aperti e confinati nei siti di bonifica – Rev.0";
- ISPRA (formerly APAT), June 2009 "Appendice V – Applicazione dell’Analisi di Rischio ai Punti Vendita Carburante ai Criteri metodologici per l’applicazione dell’analisi assoluta di rischio ai siti contaminati" (Appendix V);
- ISS/ISPEL database (update 2018);
- ASTM E2081-00 (2004), “Standard Guide for Risk-Based Corrective Action”, ASTM International
- APAT, June 2008 "Documento di riferimento per la determinazione e la validazione dei parametri sito-specifici utilizzati nell’applicazione dell’analisi di rischio ai sensi del D.Lgs. 152/06";
- APAT, March 2008 "Criteri metodologici per l’applicazione dell’analisi assoluta di rischio ai siti contaminati rev. 2".

## 3. Pilot-scale application in field

### 3.1 Extraction system

The remediation approach involved the application of a Pump and treat (P&T) intervention on groundwater (with subsequent reintroduction in the hydrogeological upstream groundwater) and a joint intervention of air sparging (AS) and soil vapour extraction (SVE) on unsaturated soil.



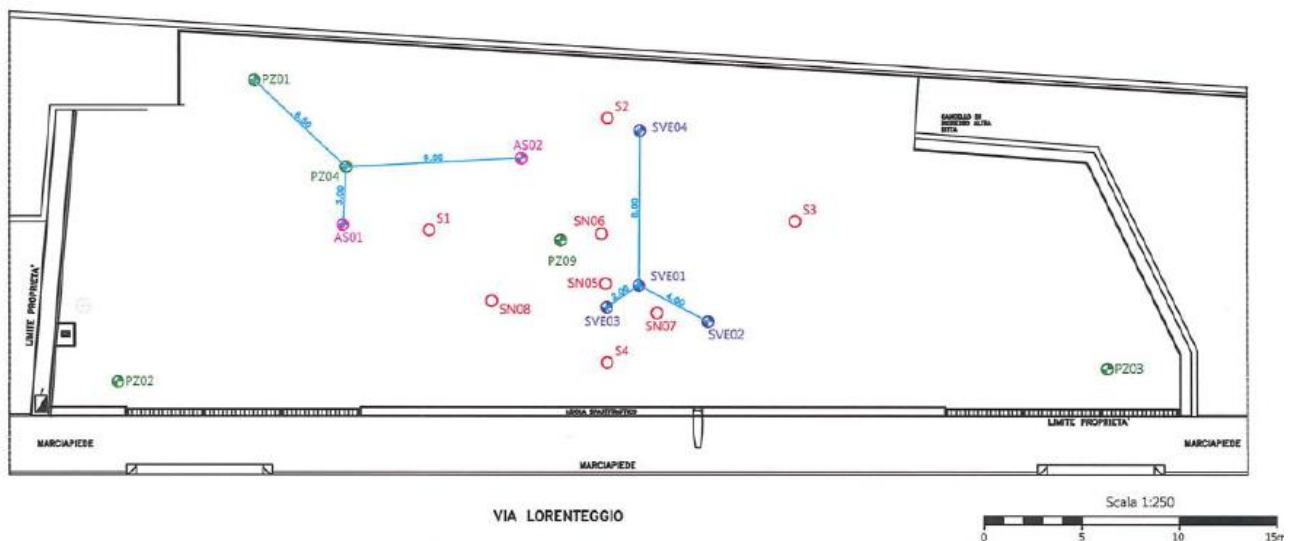

In order to assess the applicability of the AS (Air Sparging) technologies for the aquifer and SVE (Soil Vapour Extraction) for the unsaturated soil to the site under examination, pilot tests of AS and SVE were performed.

These results showed that neither the introduction of air into the groundwater nor the extraction of air from the subsoil have significant effects on groundwater levels at the design flow rates of the plant.

On the scale of the pilot test, n. 4 points for the execution of the Soil Vapour Extraction test were prepared by core destruction perforation and pushed to a depth of 6 m from the local p.c., then equipped with 2" PVC piping.



#### LEGENDA

-  Sondaggi realizzati per la caratterizzazione ambientale del sito
-  Piezometri realizzati per la caratterizzazione ambientale del sito
-  Punti di Air Sparging da realizzare
-  Punti di SVE da realizzare

In order to assess the applicability of the SVE technology to the site in question and determine the range of action induced in the ground by the suction of air, a step test was conducted by placing a point in suction and using other wells as monitoring points.



## 3.2 Injection system

In the pilot scale application, specially drilled wells were used (boreholes pushed up to 6 m from the local p.c., equipped with a 2" PVC pipe) and the carrier gas used was atmospheric air (the same then used at the real scale).

### 3.3 Radius of influence

In the pilot scale application, a step test was carried out, placing the SV01 point in suction with increasing flow rate steps and using points SV02, SV03 and SV04 as monitoring points.

The extraction and blowing system used a dry vane compressor. For the treatment of interstitial vapours extracted from the subsoil, activated carbon cartridges for air were used.

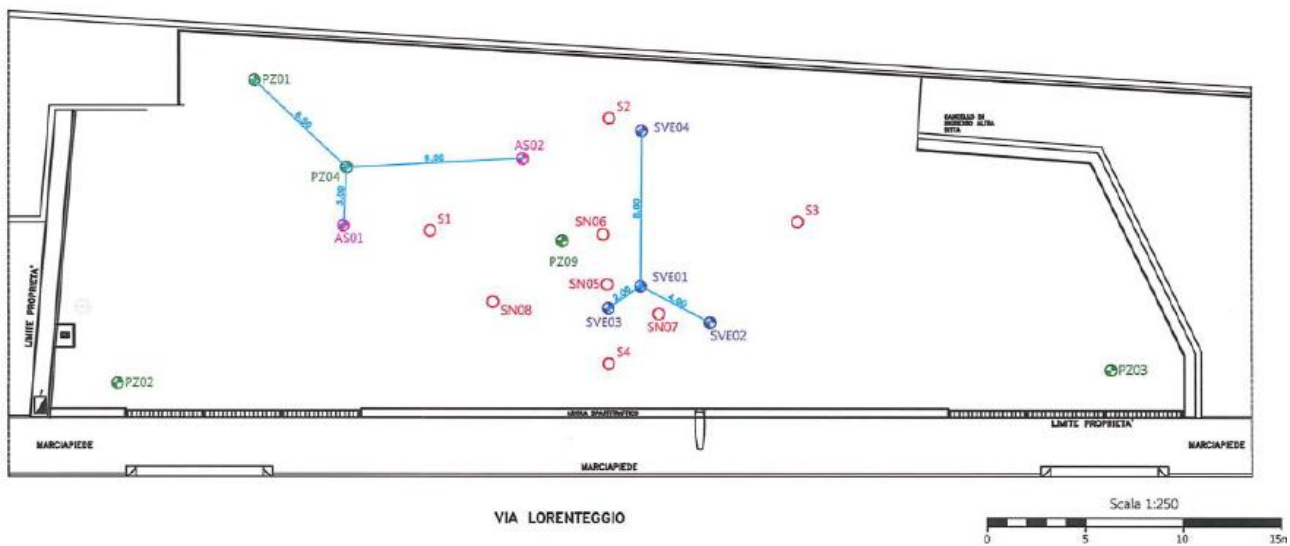

The extraction of unsaturated air at point SV01 induced, at the maximum flow rate used ( $80 \text{ m}^3/\text{h}$ ), a depression of the order of 15 mbar at the suction point and a maximum of 0.3 mbar in the SV02 located 4 m from the extraction point.

As the extraction rate varied, there was a sharp increase in the amount of Volatile Organic Compounds (VOCs) extracted from point SV01, with maximum values of the order of 300 ppm.

Considering, in accordance with the industry guidelines, the value of 0.25 mbar as the minimum significant depression to have an influence on the suction side, it is possible to establish a range of action of the SVE, at the maximum tested flow rate, between 2 and 3 m.

In order to verify the applicability of the AS technology to the site under examination, determine its range of action and verify the combined effect AS + SVE, a step test was carried out to blow air inside point AS01, using points SV02, SV03, SV04, AS02, PZ04 and PZ01 to monitor the test parameters. In the combined test point SV01 was placed under

suction, with a constant flow rate and set by determining the flow rate steps of the air introduced in point AS01.

A second test carried out on AS and SVE kept the flow of air extracted from point SV03 constant, while in connection with point AS01, flow rate steps of injected air were set.

At the end of the SVE tests, exploiting the oxygenation of the soil induced by the recall of air, a BV test was performed by monitoring the indicator parameters of any possible bacterial activity capable of decomposing the hydrocarbon components.

The parameters used for the dimensioning of the SVE system were chosen according to the results of the pilot test, which can be summarized as follows:

- Calculated radius of influence, ROI: 2.7 m from the vapour extraction point;
- Depression applied to each point SVE, PEa: from -10 to -20 mbar;
- Extraction rate for each SVE point, QEa: about 70 Nm<sup>3</sup>/h.

From the results of the pilot tests and from the definition of the Conceptual Model of the site, the parameters for calculating the duration of the remediation were defined:

- Extraction rate for each SVE point, QEa: about 70 Nm<sup>3</sup>/h;
- Air inlet pressure at each point AS: QIa: about 300 mbar Nm<sup>3</sup>/h;
- VOC concentration entering the remediation system, Ci: 430 mg/Nm<sup>3</sup>;
- Estimated volume of the source of contamination, V: 800 m<sup>3</sup>;
- Concentration of contaminants in the source of contamination, Cc: 8802 mg/kg.

The overall duration of the reclamation of the subsoil was estimated in the project in the order of 3 years.

### 3.4 Off gas Treatment

For the pilot plant, a capture system was used consisting of activated carbon cartridges, which were then disposed of (code EER 19.13.02).

### 3.5 Control parameters

The pilot scale monitoring and sampling plan evaluated the concentration variations of VOCs (volatile organic compounds) using a portable PID photo ionizer and estimated the triggering of bacterial activity in the soil by evaluating the variations of O<sub>2</sub> and CH<sub>4</sub>. To assess full-scale applicability, the following were measured, as the operating flow rates vary:

- extraction flow, depression and VOC concentration on the air extraction line.
- depression and VOC concentration on monitoring points

In the AS and combined AS and SVE test the following were monitored:

- inlet flow rate and pressure on the air inlet line
- extraction flow, depression and VOC concentration on the air extraction line.
- VOC concentration, temperature, dissolved oxygen and groundwater level at the monitoring points during the first test
- depression and VOC concentration on the monitoring points during the second test

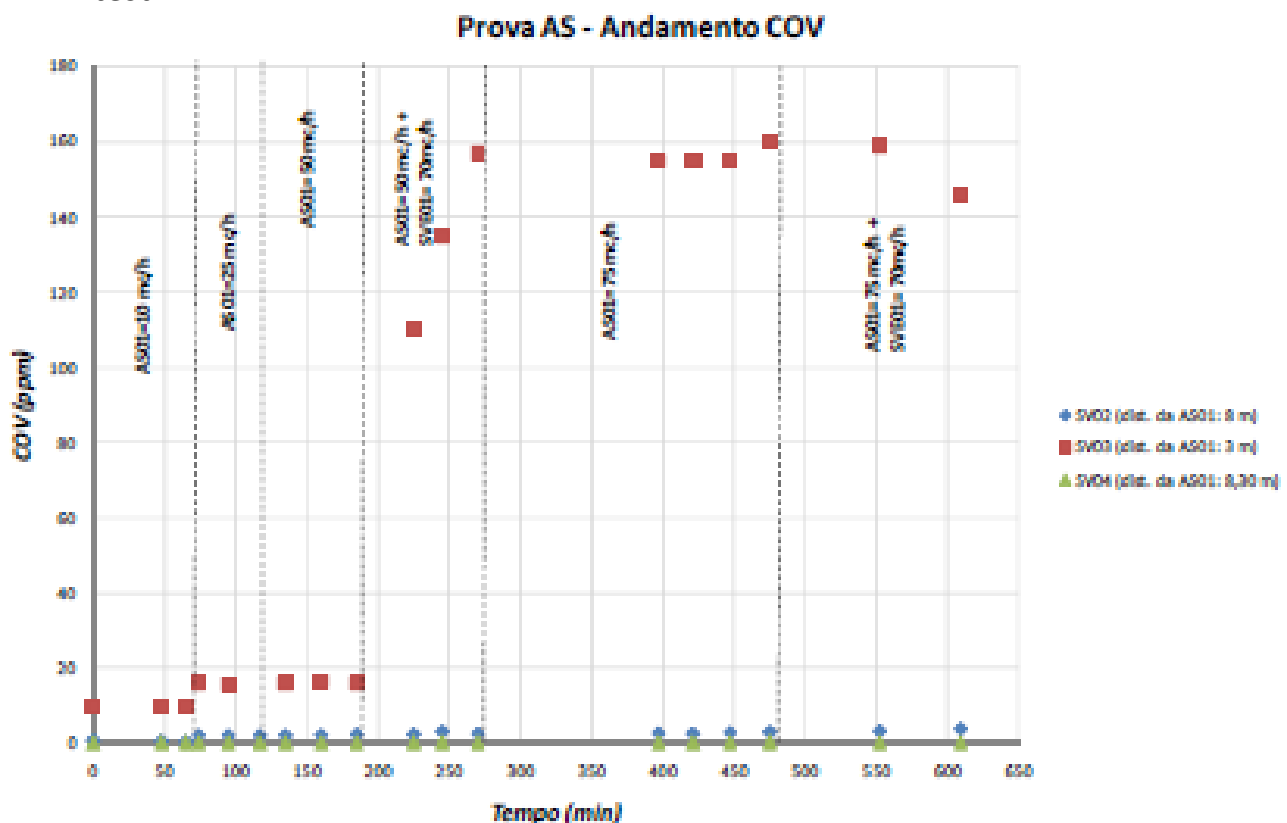

First test results



### Prova combinata AS-SVE

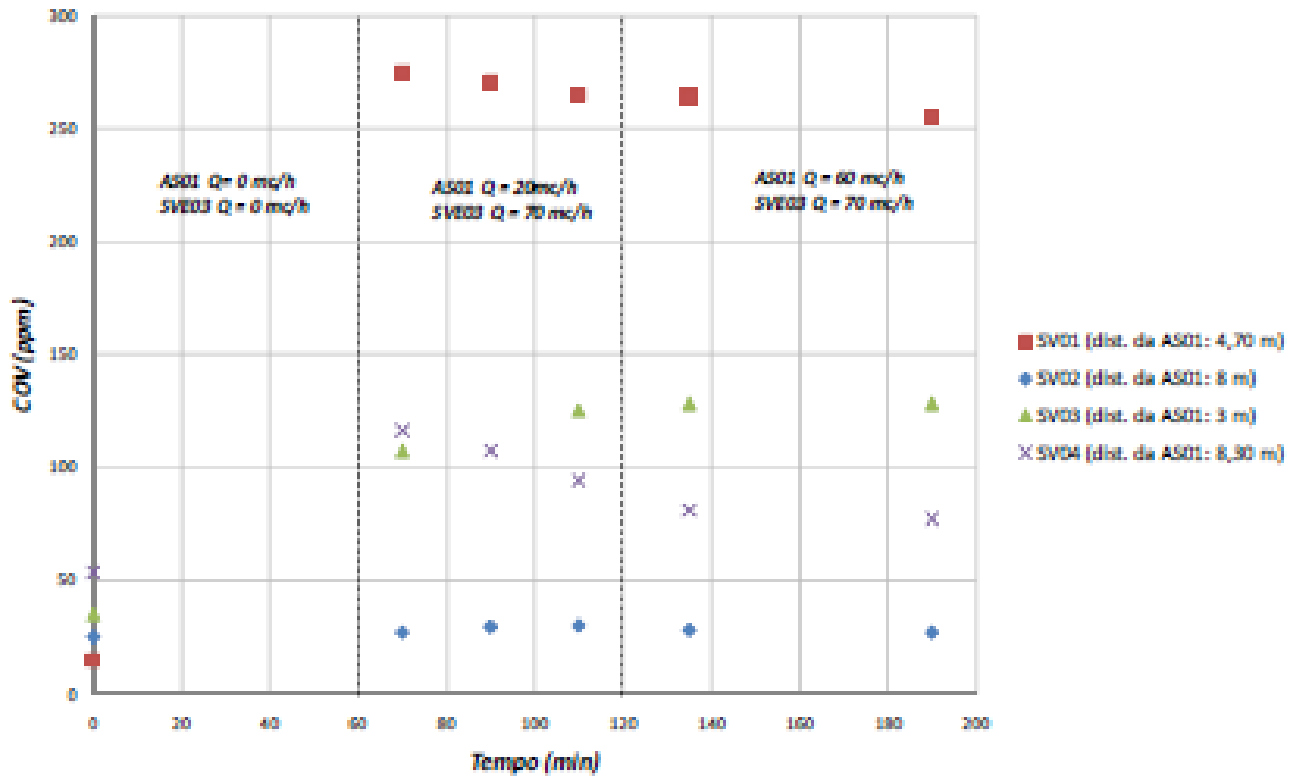

Second test results

## 4. Full-scale application

### 4.1 Extraction system

The number, spatial location, and construction characteristics of the vapour extraction points were defined in consideration of the ROI determined through the pilot tests, the areal and vertical distribution of the contamination, without neglecting the litho-stratigraphic structure of the site.

The parameters used for the dimensioning of the SVE system were chosen according to the results obtained from the pilot test; in particular, the following project parameters were assumed:

- Calculated radius of influence, ROI: 2.7 m from the vapour extraction point;
- Depression applied to each SVE point, PEa: from -10 to -20mbar;
- Extraction rate for each SVE point, QEa: about 70 Nm<sup>3</sup>/h.

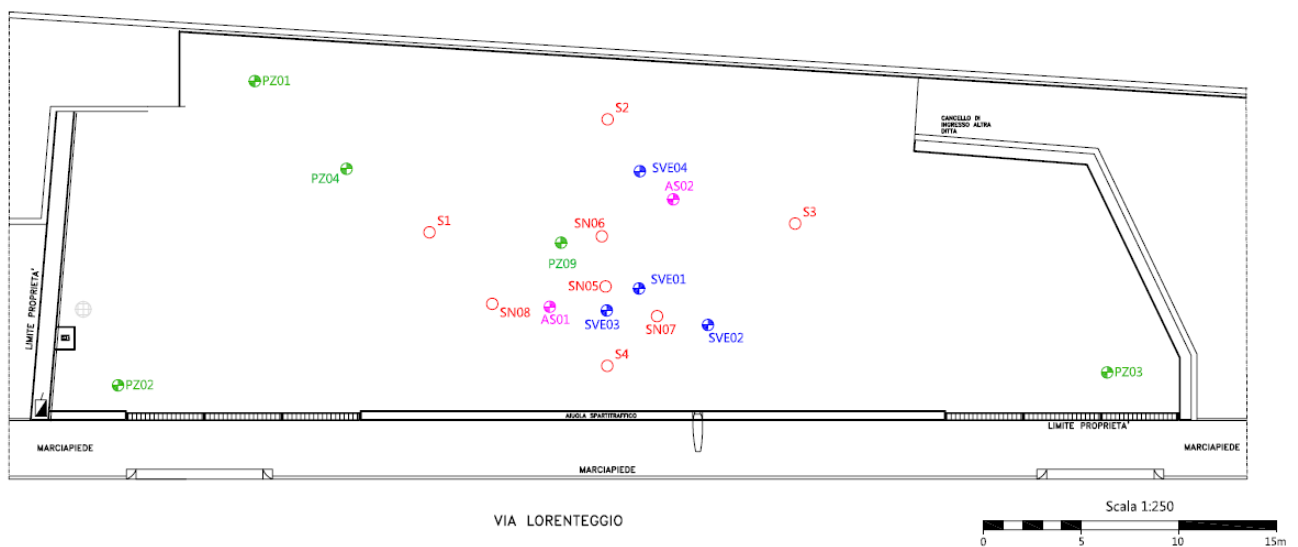

The vapour extraction system consists of 10 points, all made by means of core destruction drilling, with the housing in the sounding hole of a non-toxic PVC pipe with a diameter of 2", installed at a maximum depth of 9 m from the ground level (in particular, some SVE wells were built up to 9 m deep and with a filter section between 7 and 9 m from the local ground level; some SVE wells pushed up to 7 m deep and with a filter section between 5 and 7 m from the local ground level; some SVE wells pushed up to 4 m deep and with a filter section between 2 and 4 m from the local ground level).

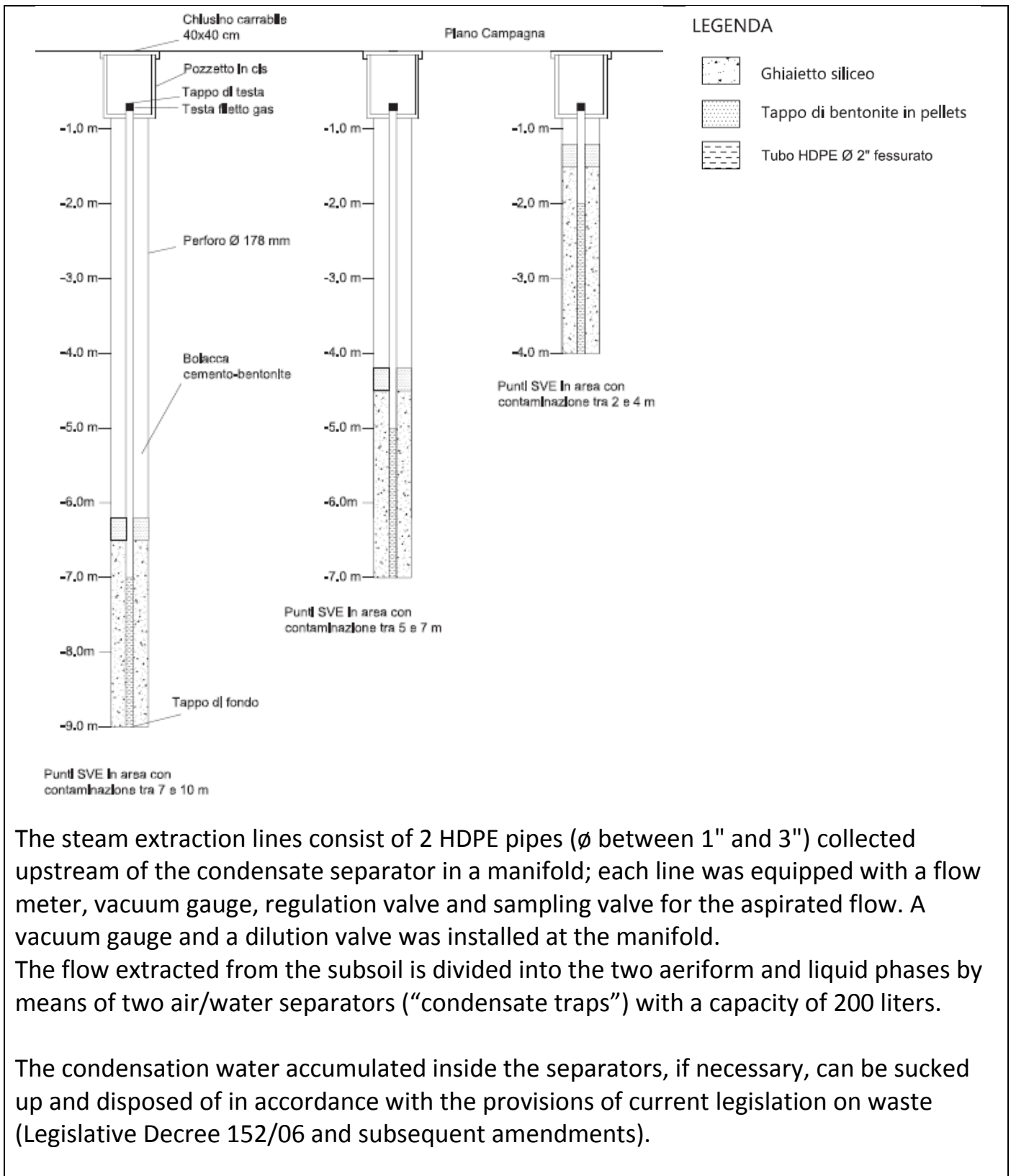

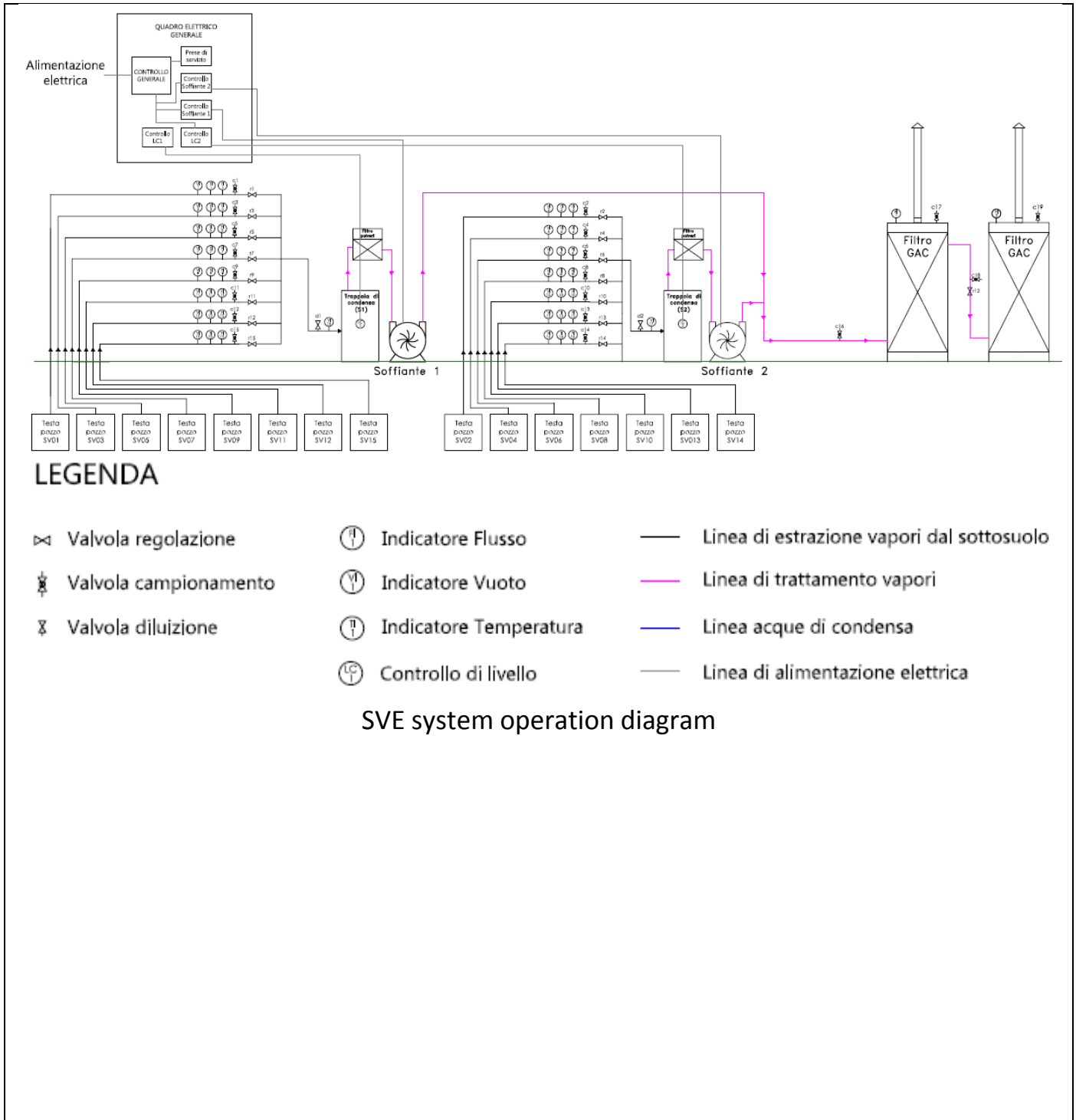

### LEGENDA

- |   |                       |   |                                  |   |   |
|---|-----------------------|---|----------------------------------|---|---|
| ⊗ | Valvola regolazione   | ⊕ | Indicatore Flusso                | — | Linea di estrazione vapori dal sottosuolo |
| ⊗ | Valvola campionamento | ⊖ | Indicatore Vuoto                 | — | Linea di trattamento vapori               |
| ⊗ | Valvola diluizione    | ⊕ | Indicatore Temperatura           | — | Linea acque di condensa                   |
| ⊕ | Controllo di livello  | — | Linea di alimentazione elettrica |   |   |

SVE system operation diagram

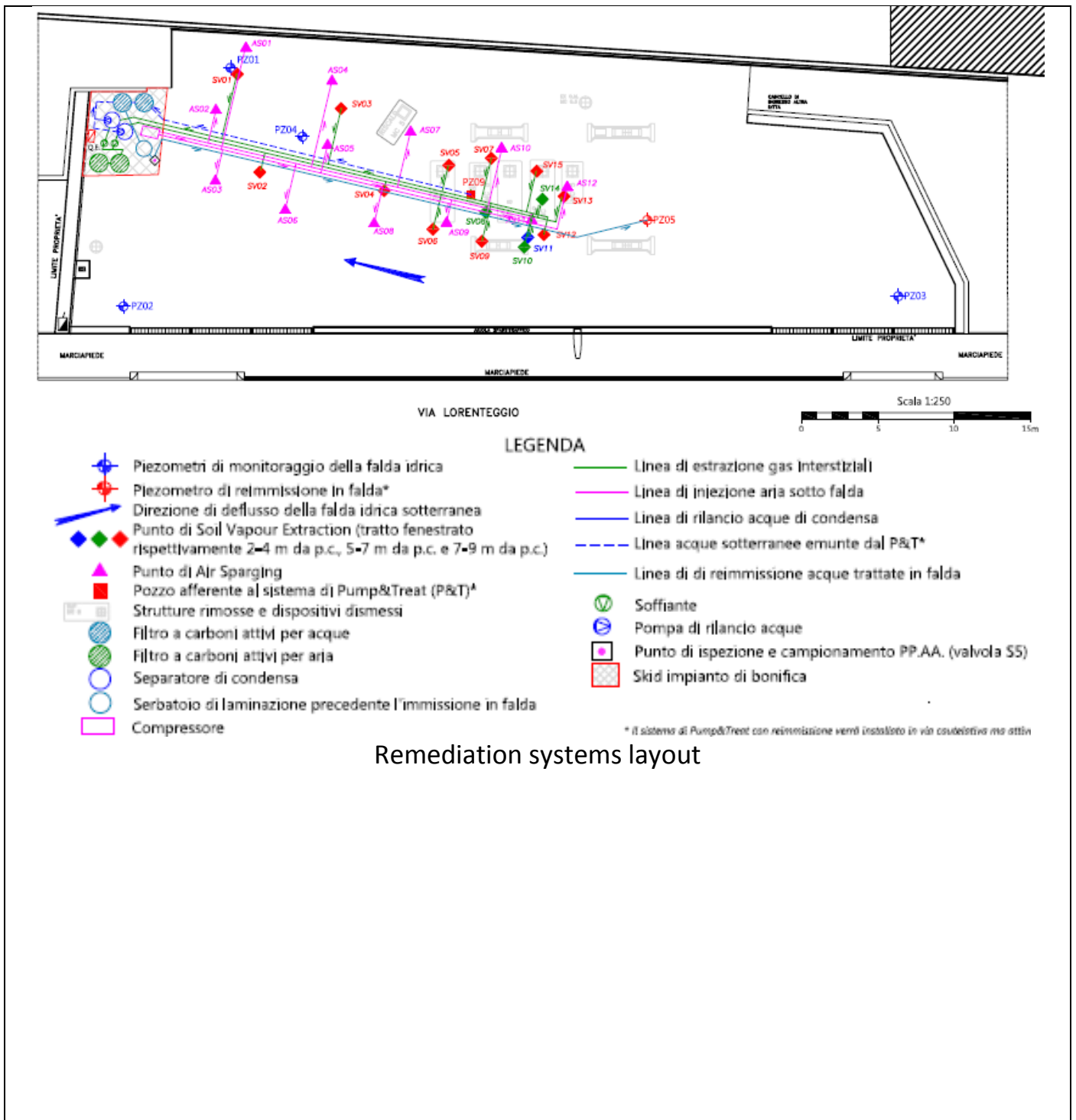

Remediation systems layout



## 4.2 Injection system

In the full-scale application, atmospheric air was used as a carrier gas and the system was built with the installation of n. 10 SVE wells.

The ventilation system has provided for the installation of 2 side channel blowers (regenerative blower), by means of which to induce a depression in correspondence with the vapour extraction wells created/positioned in order to treat specific portions of unsaturated subsoil, favouring the desorption of the contaminants from the solid phase to the gas phase.

The criterion underlying the design choice to use two blowers was based on the opportunity to alternate the steam extraction points on two separate lines, allowing some flexibility in managing the system and letting it operate during partial maintenance.

In particular:

- BLOWER 1 - afferent to 8 steam extraction points, capable of reaching a depression between -200/-250 mbar, for a total flow rate of approximately 560 Nm<sup>3</sup>/h, in order to guarantee an equal air flow for each extraction point at about 70 Nm<sup>3</sup>/h;
- BLOWER 2 - afferent to 7 steam extraction points, able to reach a depression between -200/-250 mbar, for a total flow rate of about 500 Nm<sup>3</sup>/h, so as to guarantee an equal air flow for each extraction point at approximately 70 Nm<sup>3</sup>/h.

The blowers, each connected to a group of suction points, work individually alternately according to on/off cycles controlled by a timer.

## 4.3 Radius of influence

The operating range of influence used in the project was assumed to be equal to the ROI obtained from the pilot tests, i.e. 2.7 meters for each single ventilation point.



## 4.4 Off gas Treatment

The vapours extracted from the subsoil have been collected and conveyed to condensate traps, where the separation between the interstitial gas and any water vapour present in the extracted air flow takes place; the condensate water is removed from the separators by means of special booster pumps and sent to a water treatment system before being discharged into the sewer system.

The interstitial vapour, once dehumidified, passes through an anti-particulate filter before passing through the blower that generated the vacuum and only then is sent to the air handling unit.

To reduce the pollutants present in the extracted interstitial gases, a pair of filters in series with granular activated carbon was installed.

The treatment unit has also been provided with arrangements that allow the filters to be arranged in parallel in the event that the inlet flow shows compatible VOC concentrations.

The exhaustion time of the activated carbons used for the treatment of interstitial gases, estimated on the basis of very conservative theoretical calculations, was set in the project as approximately 87 days and was verified with the results of the analyzes carried out on the outgoing air samples from the plant from the respective plants.

This check made it possible to program the replacement of the carbon pack of the filters according to the actual site-specific conditions.



## 4.5 Control parameters

To evaluate the effectiveness of the SVE intervention in the three dimensions, checks were carried out during the start-up phase of the plants and subsequently with periodic checks.

The reclamation plant and the state of the sites were periodically subject to visits aimed at:

- verify the correct functioning of the systems;
- perform routine maintenance of the system;
- schedule any extraordinary maintenance interventions;
- monitor the operating parameters of the plant and possibly remodel the adjustments;
- check the quality of the flows entering and leaving the water and air treatment system.

Before starting the plant, or at  $T_0$ , a complete monitoring of the groundwater was carried out, with detection of the static piezometric level and measurement of the chemical/physical parameters with particular attention to dissolved oxygen values.

At the first start-up of the SVE/AS plant, the appropriate adjustments were made on the operating parameters (extracted/injected flows, pressures/depressions, etc.) and the simultaneous monitoring of the subsoil response (concentration of VOC -  $O_2$  -  $CO_2$  in the interstitial vapours, induced elevations in the aquifer, dissolved oxygen levels in groundwater, etc.) and the efficiency of the treatment systems.

During the setting up, the following measurements were therefore carried out every 2 days:

- relief of depressions in the vapour extraction points and on the manifold;
- survey of the VOC concentrations and the volumetric percentages of  $O_2$  and  $CO_2$  in the vapour extraction points;
- survey of the concentrations of VOCs entering and leaving the air treatment system;
- measurement of extracted flow and injection rates;
- pressure relief at the injection points;
- piezometric survey in correspondence with all wells/piezometers installed on-site;
- measurement of chemical-physical parameters with particular reference to dissolved oxygen (OD).





The set-up took about 10 days and ended with the testing of the air treatment system by sampling and laboratory analysis of the vapours entering and leaving the system.

The above analytical results allowed to validate the use of the portable photo ionizer (hereinafter PID) as a subsequent tool for controlling the quality of the effluent.

Check-ups were carried out on a monthly basis on the system in order to verify the correct functioning of the system and monitor the operating parameters of the system (extraction/injection flow rates, pressures/depressions, VOC - O<sub>2</sub> - CO<sub>2</sub> concentration in the interstitial vapours, OD concentration in groundwater, piezometric levels, etc.) making any new adjustments if necessary.

During operation, routine maintenance of the plant parts was performed (filter cleaning, etc.) and, if necessary, extraordinary maintenance (replacement of activated carbon, waste disposal, etc.).

On an annual basis, samples were taken from an absorber vial to be sent to the laboratory to analyze the gaseous flow in and out of the air treatment system.



## 6. Post treatment and/or Long Term Monitoring

### 6.1 Post treatment and/or Long Term Monitoring

Following the injection of atmospheric air into the saturated subsoil and the ventilation of the vadose portion, mobilization and removal of the volatile organic compounds present and oxygenation of the subsoil were obtained.

The increased availability of oxygen favours the aerobic biodegradation processes of hydrocarbons.

For this purpose, periodic respirometric test campaigns (every six months) were carried out during operation, which consists of monitoring the oxygen and carbon dioxide concentrations for a sufficiently long period of time (48 hours) after the shutdown of the systems' ventilation, in order to evaluate aerobic activity in the unsaturated subsoil.

In practice, once the system is turned off, the oxygen present in the interstitial gases will tend to be consumed more rapidly the greater the aerobic biological activity present. On the contrary, the concentrations of carbon dioxide will tend to increase more rapidly the more intense the aerobic biodegradative activity is in place.

On the basis of the data collected, it is possible to estimate average biodegradation rates of contaminants per soil mass in the unit of time.

A soil gas control network has not been envisaged on the site, whose proceedings began before the issuance of the Ministerial Decree 31/2015 and the National Guidelines (LG SNPA) on the soil gas matrix.

## 7. Additional information

### 7.2 Additional information

The project goal of the site remediation was indicated as definitively achieved when the concentrations of pollutant compounds adsorbed to the deep soil and dissolved in groundwater reach the relative CSR values set out in the following tables:

**Tabella 1.** Obiettivi di bonifica per suolo e sottosuolo

Sostanza indicatrice	u.m.	Obiettivi di bonifica
Piombo	mg/kg	100 <sup>(1)</sup>
Benzene	mg/kg	0,29 <sup>(2)</sup>
Etilbenzene	mg/kg	0,94 <sup>(2)</sup>
Stirene	mg/kg	0,5 <sup>(1)</sup>
Toluene	mg/kg	0,5 <sup>(1)</sup>
Xilene	mg/kg	30,24 <sup>(2)</sup>
Sommatoria organici aromatici (da 20 a 23)	mg/kg	1 <sup>(1)</sup>
Idrocarburi Leggeri C ≤ 12	mg/kg	60,8 <sup>(2)</sup>
Idrocarburi Pesanti C > 12	mg/kg	117,7 <sup>(2)</sup>
Piombo Tetraetile	mg/kg	0,01 <sup>(3)</sup>
MTBE	mg/kg	10 <sup>(4)</sup>
ETBE	mg/kg	10 <sup>(4)</sup>

(1) colonna A (siti ad uso verde pubblico, privato e residenziale) Tabella 1 dell'Allegato 5 Titolo V Parte Quarta del D.Lgs. 152/06 (CSC per i terreni)

(2) CSR approvate con Determina Dirigenziale Comune di Milano n. 596/152 del 24 novembre 2014

(3) parere ISS del 17/12/2002 n. 49759 IA.12

(4) parere ISS del 2001 n. 57058 IA/12

**Tabella 2.** Obiettivi di bonifica per le acque sotterranee

Sostanza indicatrice	u.m.	Obiettivi di bonifica
Benzene	µg/l	1 <sup>(1)</sup>
p-Xilene	µg/l	10 <sup>(1)</sup>
Idrocarburi Totali (espressi come n-esano)	µg/l	350 <sup>(1)</sup>
MTBE	µg/l	40 <sup>(2)</sup>
ETBE	µg/l	40 <sup>(2)</sup>

(1) CSC di cui alla Tabella 2 dell'Allegato 5 al Titolo V, Parte Quarta del D.Lgs. 152/06 come riportato nella Determina Dirigenziale Comune di Milano n. 596/152 del 24 novembre 2014

(2) Parere ISS del 12/09/2006 N. 45848, come riportato nella Determina Dirigenziale Comune di Milano n. 596/152 del 24 novembre 2014

**Tabella 3.** Ulteriori sostanze monitorate per le acque sotterranee

Sostanza indicatrice	u.m.	Obiettivi di bonifica
Piombo	µg/l	10 <sup>(1)</sup>
Etilbenzene	µg/l	50 <sup>(1)</sup>
Stirene	µg/l	25 <sup>(1)</sup>
Toluene	µg/l	15 <sup>(1)</sup>
Piombo tetraetile	µg/l	0,1 <sup>(2)</sup>

(1) CSC di cui alla Tabella 2 dell'Allegato 5 al Titolo V, Parte Quarta del D.Lgs. 152/06

(2) Parere ISS 17/12/2002 n. 49759 IA.12

The project envisaged that the remediation testing would be required when, for three subsequent monitoring, compliance with the remediation objectives for groundwater determined by the Site-Specific Risk Analysis and Compliance (CSC) was found at the PoC and at the same time the SVE plant had extracted zero VOC concentrations for a period of at least 3 months.

Upon verification of the above conditions, 3 monthly on/off cycles of the groundwater reclamation and sampling plants were carried out.

Following the positive outcome of the three monitoring sessions carried out in the shutdown cycles, the shutdown of the plants and the subsequent testing of the deep soil matrix was envisaged. It was proposed to carry out some probes with sampling of unsaturated matrix for verification of compliance with the CSRs defined by the risk analysis.

From the end of June 2018 to the end of July 2018, when the remediation systems were shut down, the SVE plant extracted an average flow rate of interstitial gases from the subsoil equal to about 12,000 m<sup>3</sup>/day.

In the same period, the AS plant, by means of a side-channel compressor, had blown atmospheric air into the saturated subsoil with an operating pressure of about 0.3 bar and an average flow rate of 240 m<sup>3</sup>/h.

From August to October 2018, the SVE and AS plants operated intermittently to allow the implementation of the reclamation test plan.

The duration of the reclamation of the subsoil was estimated at about 3 years, with the start-up of the plants on 27 July 2015. The operation of the reclamation plants ended in July 2018.

In the subsequent period up to January 2019, the testing activities of the environmental matrices of the subsoil were carried out. These showed compliance with the remediation objectives for groundwater and unsaturated soils in the south-east sector of the site, with the exception of the area central of the site where residual



concentrations of heavy hydrocarbons C> 12 persisted.

The checks carried out on the groundwater matrix, on the other hand, showed compliance with the CSCs of reference to the POC of the site (this situation was verified over time through the monitoring of the groundwater).

The outcome of the testing on unsaturated soil, implemented as per the approved test plan, therefore highlighted the persistence of values exceeding the established remediation objectives.

The analyses carried out by the ARPA Laboratory, on the samples taken in contradiction, show the failure to achieve the remediation objectives for the hydrocarbon parameter C> 12 in a sample taken in the depth range between 5 and 6 m from the local p.c. (the ARPA Laboratory quantifies a value of 458 mg/kg dry matter, compared to the remediation target set at 117.7 mg/kg, as defined by the reference CSR).

Similarly, the Party's data shows the non-compliance with the remediation objectives for the hydrocarbon parameter C> 12 only in two samples taken both in the same vertical survey verified by ARPA, one between 3 and 4 m deep from the local p.c. (with 880 mg/kg, compared to the CSR of 117.7 mg/kg) and one between 5 and 6 m of depth from the local p.c. (with 300 mg/kg, compared to the CSR of 117.7 mg/kg).

The checks were carried out after the period of operation of the reclamation plant in unsaturated soil. The south-east sector of the former PV shows the achievement of concentrations lower than the reclamation objectives, while in the center of the site, residual concentrations were determined in Heavy hydrocarbons C> 12 exceeding the CSR, distributed between the depths of 3 and 7.5 m from p.c..

The almost zero values of the VOCs measured in the interstitial gases extracted from the unsaturated subsoil with the SVE plant and the weak biodegradative activity determined with the respirometric test showed that the remediation systems, consisting of an SVE, AS and P&T plant, have exhausted their effectiveness in cleaning up contamination.

Faced with this evidence, it was proposed to launch a soil gas monitoring campaign on the site to measure the real flow of volatile substances present in the subsoil in order to apply the measured data as part of a risk analysis review.

For the verification of the real flow coming from the subsoil it was initially proposed to use some of the existing SVE wells for the soil gas monitoring network. In view of the observations made by ARPA (which assessed the dimensions and depths of the filtering sections of the proposed SVE wells as non-compliant with the specifications of the LG SNPA), the installation of 3 soil gas probes of the "nesty probe" was therefore proposed. The monitoring activities of the soil gas matrix, which will be carried out for an annual duration with seasonal campaigns (quarterly sampling), will be used to obtain direct data to be used for a review of the risk analysis.

## 1. Contact details - CASE STUDY: SVE n.17

<b>1.1 Name and Surname</b>	Confalonieri Massimiliano, Panzeri Paola, Canepa Paola
<b>1.2 Country/Jurisdiction</b>	Italy
<b>1.3 Organisation</b>	ARPA Lombardia
<b>1.4 Position</b>	Dirigente RUO BARAE
<b>1.5 Duties</b>	
<b>1.6 Email address</b>	<a href="mailto:m.confalonieri@arpalombardia.it">m.confalonieri@arpalombardia.it</a>
<b>1.7 Phone number</b>	+39 335 531 8045

## 2. Site background

### 2.1 History of the site

The site covered by this questionnaire is known as EX BRENNTAG DEPOSITO and is located in an industrial area north-west of Milan, in the municipality of Bollate.

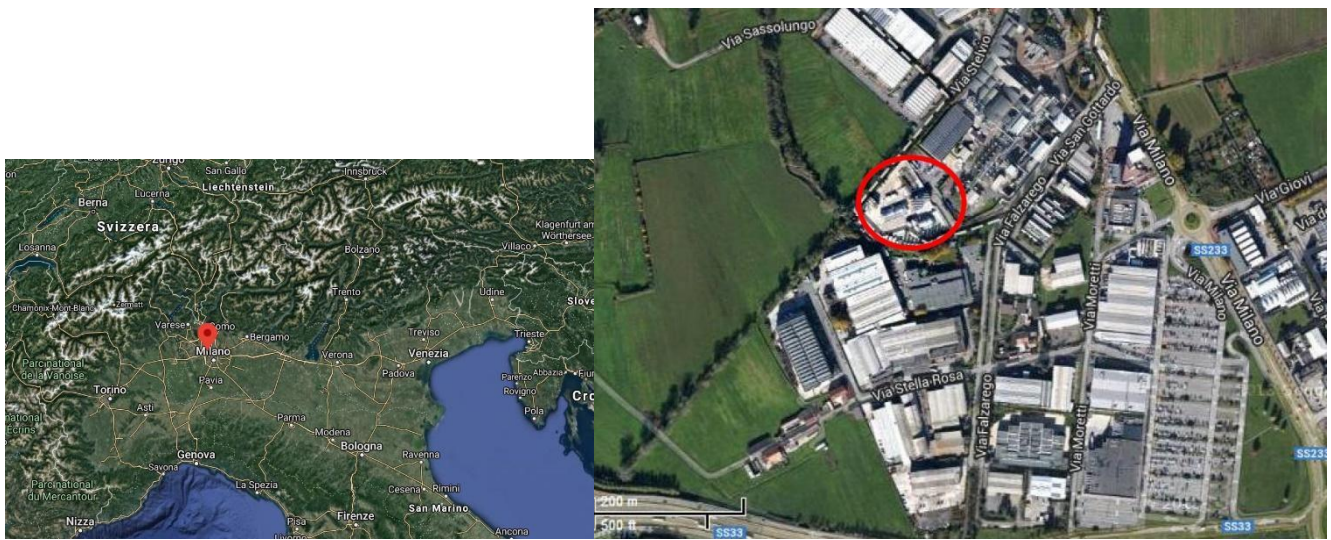

The area is not part of a Site of National Interest.

The company, active since the late 1950s, deals with the storage and distribution, wholesale and retail, of chemical substances and is one of the Industries at Risk of Major Accident subject to Legislative Decree no. 105/2015 called "Seveso III Decree".

The deposit initially covered only a limited part of the current surface and consisted of 10 vertical 30 m<sup>3</sup> above ground tanks, located along the southern border, and 11 (plus 5 installed after a few years) buried tanks of 30 m<sup>3</sup> each. (some of which divided into two compartments), arranged along the western border; all these tanks have now been removed and demolished. From notes of the time, it seems that the products stored were the following:

- Underground tanks: dichloroethane, MEK, Acetone, Ethyl alcohol, Methyl alcohol, Isobutyl acetate, Ethyl acetate, IPA, Heptane, Octane, Toluene, Hexane, Cyclohexane, Trieline, Tetrachloroethane, Sulphuric ether, Solvent naphtha from petroleum, THF, MIBK
- Above Ground Tanks: Ethyl glycol, Butyl glycol, Ethylene Glycol, Propylene Glycol, Propylene Glycol USP, Methyl glycol, Methyl glycol Acetate, Cyclohexanone and Cyclohexanol

The deposit has undergone various modifications over the years; was expanded in 1968

(10 tanks of 50 m<sup>3</sup> above ground), in 1974 (25 tanks of 50 m<sup>3</sup> underground) and in 1985 (7 tanks of 50 m<sup>3</sup> above ground, 6 horizontal tanks of 50 m<sup>3</sup> above ground (subsequently demolished) and 1 tank of 100 m<sup>3</sup> horizontal above ground) when it has reached the maximum storage capacity.

Over time, phthalates, n-paraffins, dichloropropane and various types of esters have been added to the products mentioned. In the mid-1990s, however, chlorinated products were eliminated, with the exception of dichloropropane, which was eliminated at a later time.

It should be noted that in the mid-1990s some above ground tanks located along the border of the site with the Guisa stream were removed and in 1998 the underground tanks arranged along via San Gottardo, to the left of the entrance to the industrial area, were removed.







## 2.2 Geological setting

The area under study is located in the central sector of the Milanese mid-plain and is characterized by a sub-flat morphology, with topographic altitudes degrading towards the South, linked to fluvio-glacial and fluvial deposition of the Quaternary age. The morphological structure of the territory consists of extensive fluvio-glacial plains. To the south of the industrial site, the Guisa stream flows eastwards. The site consists of Postglacial Unity (Upper Pleistocene - Holocene), consisting of fluvial deposits with no alteration profile and poorly developed soil, less than one meter thick. From a lithological point of view, the deposits are generally made up of slightly silty sands, with interspersed gravels with a clastic support or a sandy matrix, generally loose.

In the area under examination, the hydrogeological units follow one another, from the most superficial to the deepest, according to the following scheme:

**Aquifer Group A:** consisting of deposits in high-energy braided fluvial facies. Lithologically it is mainly composed of coarse gravelly-sandy sediments with a medium-coarse sandy matrix with subordinate sandy intervals from medium to very coarse, with high porosity and permeability; locally there are decimetric levels of clay and silty clays and horizons consisting of cemented and conglomerate gravels. The thickness varies from a minimum of 26-30 m up to a maximum of 40-45 m and its lower limit is placed in correspondence with the first truly continuous clayey levels;

**Aquifer Group B:** consisting of deposits in braided fluvial facies. Lithologically it is mainly composed of coarse sediments represented by medium-coarse sands, pebbly sands and gravels with a sandy matrix with high porosity and permeability; downwards the granulometry of the sediments decreases and the cemented horizons (sandstones and conglomerates) and the levels of fine clayey-silty sediments become more frequent. The overall thickness is around 45 m on average with minimum values around 35 m and maximum values of 55 m.

**Aquifer Group C:** consisting of deposits in continental/delta transitional facies. Lithologically it consists of fine to medium sands and silty clays with peaty horizons interspersed with gravel-sandy levels with greater permeability. The overall thickness is unknown as the lower limit was not reached by the drilling of the deepest wells in the area. In the permeable levels there are intermediate and deep aquifers, of the confined type, whose vulnerability is mitigated by the presence of continuous clayey layers on the roof, but connections and feeding by the highly vulnerable upper free aquifer cannot be excluded.

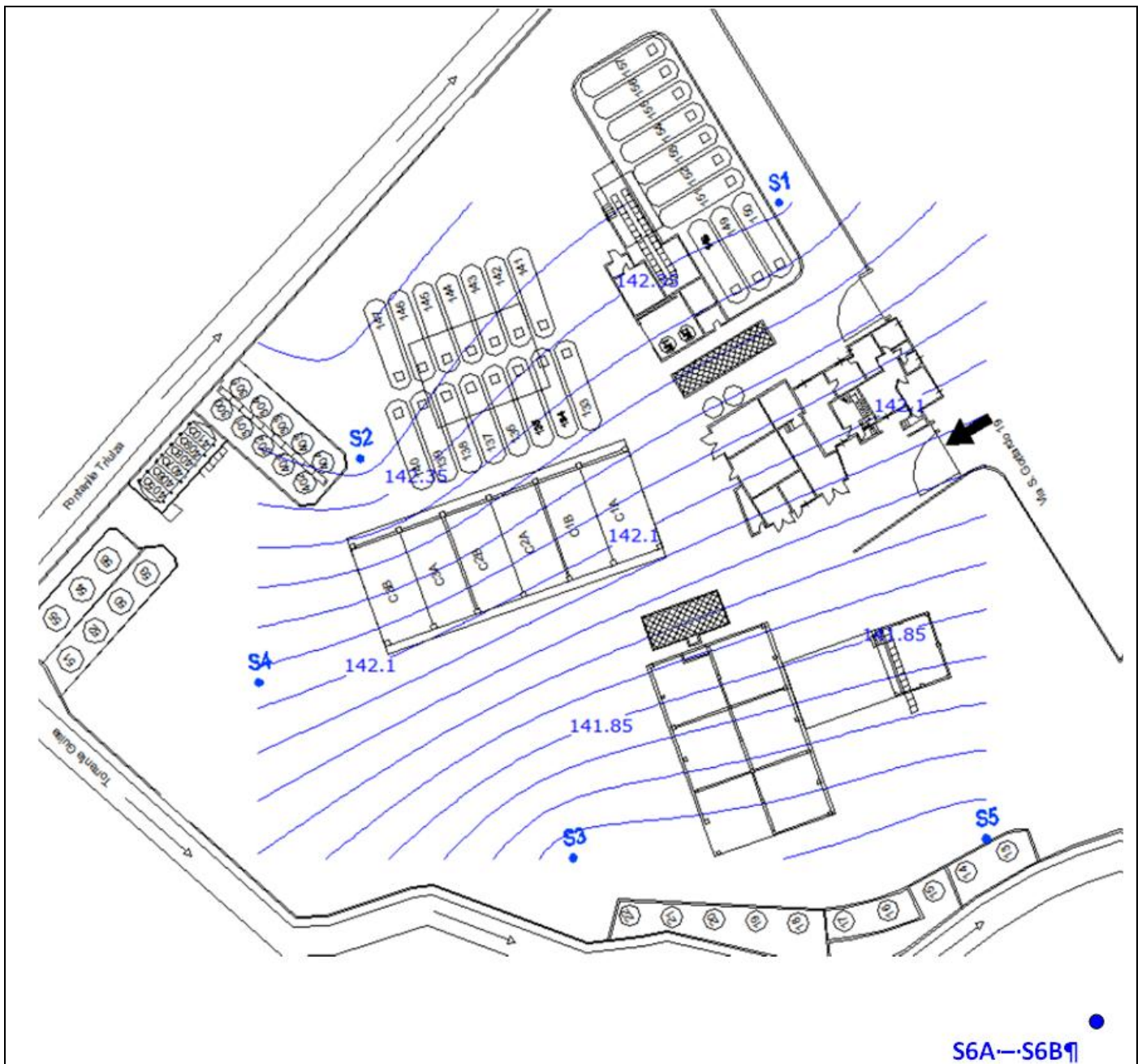

The aquifer groups A and B described above are the seat of the main free-type or locally semi-confined aquifer, characterized by subsidence around 20-30 m from the ground level, traditionally captured by the collection wells for drinking water purposes of old construction and from private wells (information taken from the document "Componente geologica, idrogeologica e sismica del Piano di Governo del Territorio" of the Municipality of Bollate, drawn up in 2010 by the "Studio Idrogeotecnico").

Specifically, in the area in question, it is possible to identify 2 distinct layers, separated from each other by a clay lens placed at a depth of 20 m; the static level of the surface



aquifer is around 8 m deep.

The image above shows the isopiezometric map drawn up in 2014 (the static levels were measured on 28/02/2014) for the additions to the site characterization plan; we deduce that the direction of the water table is NNE-SSW, with a gradient of about 1.6 ‰. The figure shows the 7 piezometers that make up the monitoring network and which were grounded in 1994.

The characteristics of the monitoring points are summarized below:

ID	Diameter - inches	Depth - m	volumetric flow (19/03/2014) - l/s
S1	4"	20	
S2	4"	15	0.5
S3	4"	20	0.2
S4	4"	18.5	
S5	4"	18	0.4
S6A	2"	20	
S6B	2"	38	

The S2, S3 and S5 piezometers are equipped with submersible pumps for the continuous pumping of water; these piezometers are part of the Pump and Treat (P&T) system which has been active since 21/09/1994. The plant consists of:

- a 30 m<sup>3</sup> tank for the collection and homogenization of the water extracted from the reclamation wells;
- a stripping tower for water purification;
- two activated carbon filters, with 80 kg carbon load, positioned in series, for the treatment of gases coming from the stripping tower;
- two activated carbon filters (4,000 kg + 1,000 kg approx.) for the treatment of wastewater leaving the stripping tower;
- a sand filter (approx. 1,000 l) to protect the activated carbon filter for water treatment.

The plant is also designed for the collection and purification of rainwater.

The treated water is discharged into the Guisa stream, which flows immediately downstream of the area.

## 2.3 Contaminants of concern

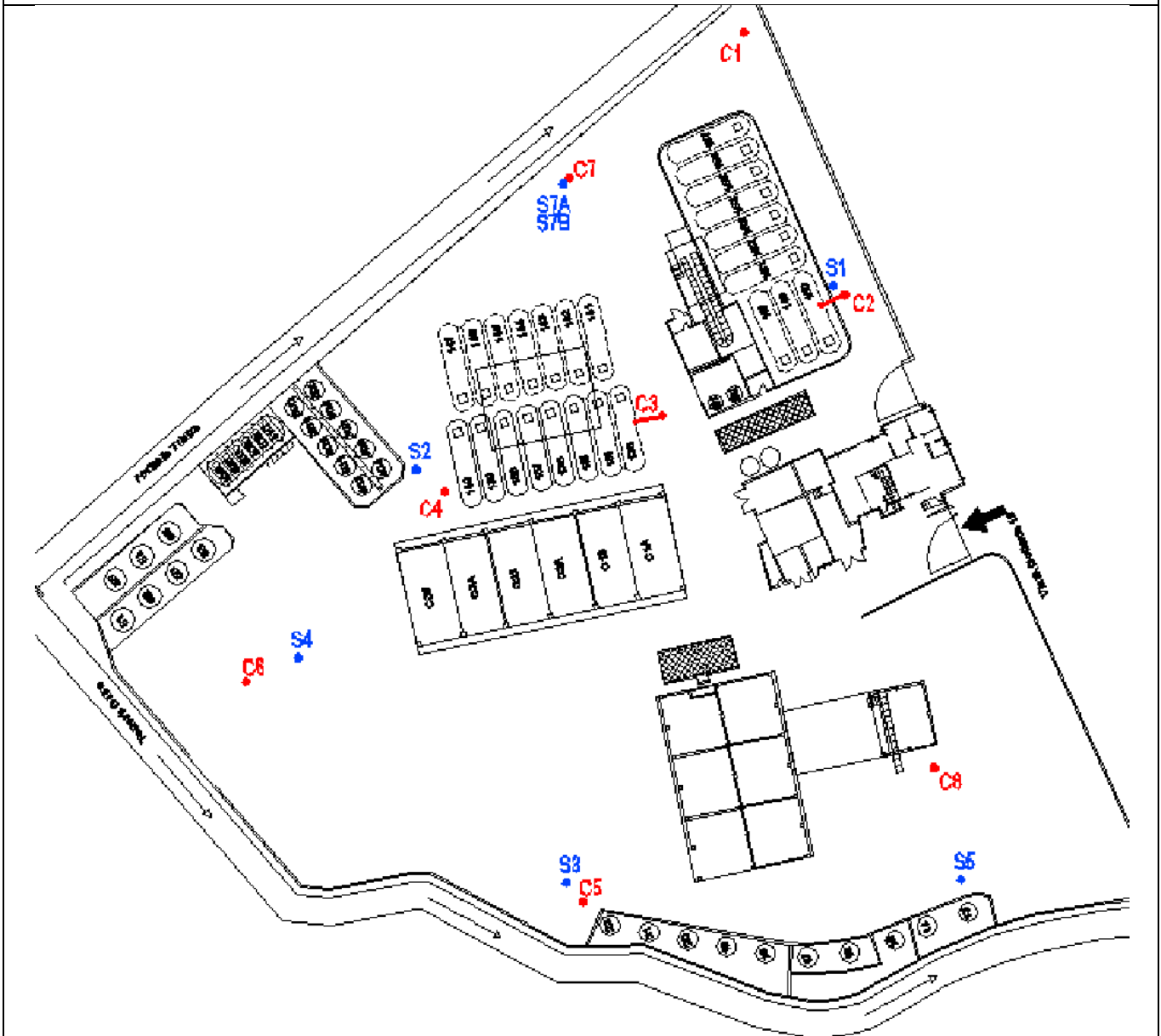

The site is characterized by contamination by chlorinated solvents, affecting both the land and the groundwater. The following figure shows the location of the surveys carried out (in red) for the characterization of the land and the location of the piezometers making up the groundwater monitoring network underlying the site (in blue). During the characterization activities, two additional piezometers, 2" each, respectively about 20 m deep (identification code S7A) and 40 m (identification code S7B) were installed with the aim of creating a monitoring point of the surface water



table ( S7A, to be compared with S6A) and a monitoring point of the deeper aquifer (S7B, to be compared with S6B). Each bore reached a depth of about 6 m from ground level and for each of them 3 soil samples were taken, one of superficial soil (between 0 and 1 m from b.c.), one intermediate and one in the last meter of the survey.

The analysis on the soil samples taken showed a contamination in correspondence of the C8 survey, both for the superficial and deep soil:

- surface soil (sample taken between 0.2 and 1 m from bw): Hydrocarbons C <12, Benzene and Tetrachlorethylene
- deep soil (sample taken between 2.3 and 2.7 m from b.c.): Trichloromethane and Trichlorethylene.

The maximum concentrations measured (taken from the Operational Remediation Plan, presented in December 2015) are shown in the following table.

<b>Contaminants</b>	<b>Maximum concentrations (mg/kg)</b>
Hydrocarbons C <12	2,120
Benzene	4.11
Tetrachlorethylene	50.7
Trichloromethane	10,536
Trichlorethylene	26,076

It has been estimated that the contamination affects an area of about 200 m<sup>2</sup>, located at a depth of 5 m, for a volume of about 1000 m<sup>3</sup>.

As regards groundwater, both the most superficial and the deepest aquifers present contamination by chlorinated solvents, but with significant differences in the concentrations of PCE (main contaminant) which are lower in the deeper aquifer where the concentration could also be linked, in part, to an upgradient contribution.

## 2.4 Regulatory framework

The reference limits considered are those contained in Legislative Decree 152/06, Tab. 1, Col. B (intended industrial use).



### 3. Pilot-scale application in field

#### 3.1 Extraction system

In the area reclamation project and related additions, the construction of an SVE (Soil Vapor Extraction) treatment plant was proposed, in the area around survey C8, characterized by the presence of soils contaminated mainly by chlorinated solvents. In the Reclamation Project it was proposed to combine the SVE also with an AR (Air Sparging) treatment for groundwater. It should be emphasized that on the site, as reported above, an operational safety system is already in operation consisting of 3 points of extraction of the groundwater, which are then sent to a treatment plant. This system will remain in operation also during the SVE/AS treatment.

Between 9 and 10 November 2016, the drillings were carried out for the preparation of the test field for the pilot test, which was carried out between 14 and 16 November. During the execution of the test the first SVE point made (later called SVEold) showed problems and, consequently, on 2/12/2016 a second SVE point was made to replace it. On 11/01/2017 the pilot test on the new point was repeated.

The technical-constructive characteristics of the survey points making up the test field are summarized in the following table:

Point	well	Diameter	Depth (m)	Screen (m)
SVE and SVE old	40X40	3"	4	1-4
SGS1	30X30	6 mm (rilsan)	1.5	1.2-1.5
SGS2	30X30	6 mm (rilsan)	1.5	1.2-1.5
SGS3	30X30	6 mm (rilsan)	1.5	1.2-1.5

The SVE point represents the aspiration point for the Soil Vapor Extraction (SVE) test and the SGS points were used as soil gas monitoring during the SVE tests.

The following figure shows the location of the survey points of the test field. In the image, the AS point is also indicated, which represents the air blowing point for the Air Sparging test (AS) and the MAS points, used as groundwater monitoring during the AS tests.

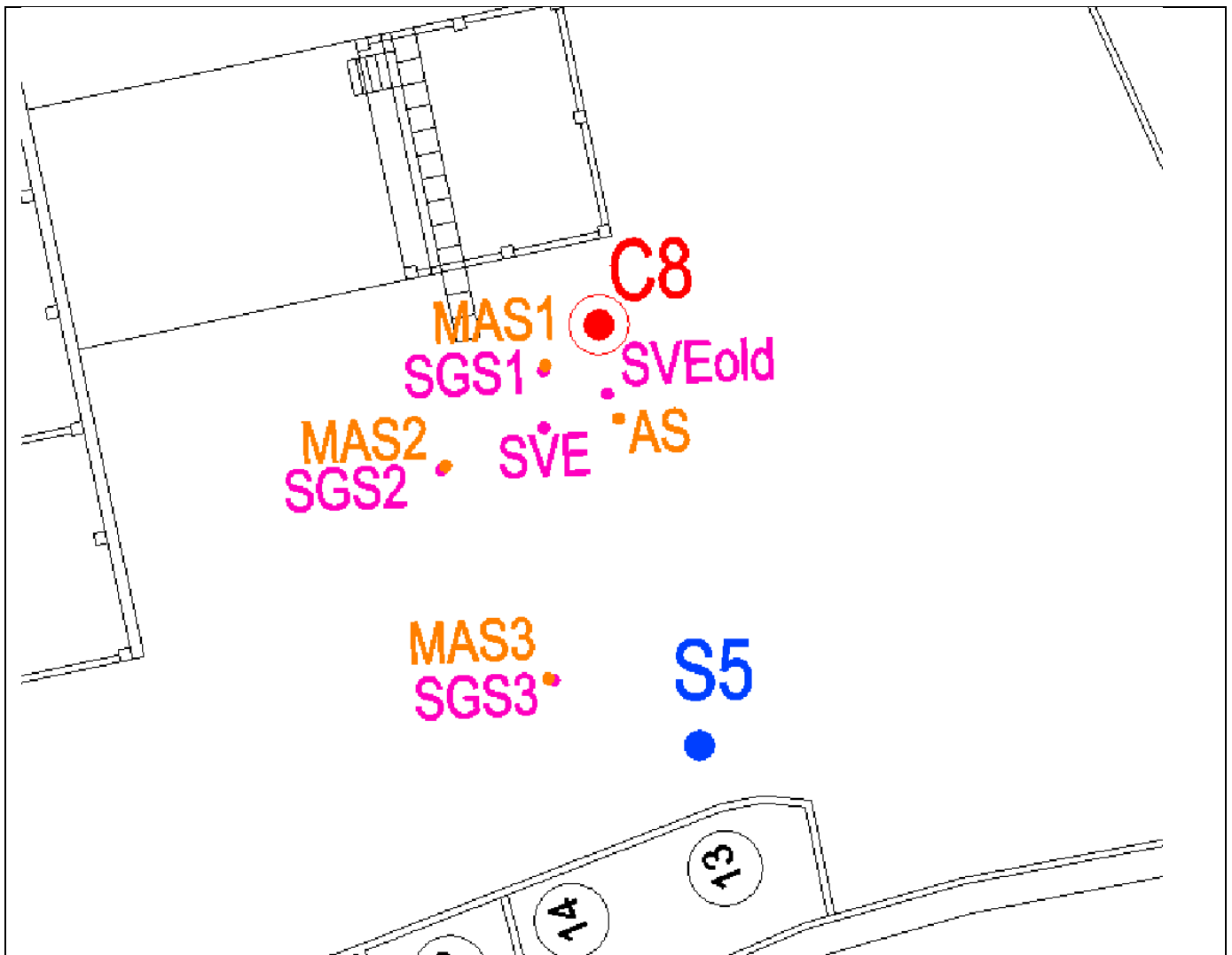

The following table shows the stratigraphy of the SVE point.

Depth (cm from ground level)	Description
0-30	Concrete slab
30-180	Filling consisting of slightly silty sands and gravels with some brick, brown color
180-300	Coarse sands and gravel with pebbles, gray/black color
300-400	Coarse sands and gravels, ocher color

The pilot test on the new SVE point was carried out on 11/01/2017.

The pilot tests were carried out by installing, at the SVE point (see image below), an aspiration system equipped with an activated carbon filter consisting of a rotary blower, regulation valves and vacuum-tight pipes.



The pilot test was performed by sucking air from the SVE point and monitoring, with field instruments, the following parameters:

- VOC (volatile organic compounds) of interstitial gases with the use of a Portable Photoionizer (PID);
- concentrations of oxygen, carbon dioxide, Lel (Lower Explosive Limit) of interstitial gases with a portable IR instrument;
- depressions induced by the rotary blower with a digital pressure gauge (thermo anemometer).

The parameters were measured at the monitoring points arranged around the suction point at distances varying between about 2 m and 8 m from the central point; the following table shows the name of the monitored points and the distance from the SVE point:





Monitoring point	Distance from SVE (m)
SVEold	2.4
SGS1	1.9
SGS2	3.7
SGS3	8.4

The SGS points intercept the horizon between 1.2 and 1.5 m from ground level.

The SVEold point has filters between 1 and 4 m.

First of all, a rapid flow step test was performed, increasing the pump flow in order to identify the flow rate to be used in the constant flow test. The constant flow test was then carried out and lasted for 5 hours, in order to verify the trend of the parameters in the subsoil, following the activation of an SVE system. The rotary pump was set at an average flow rate of 47 mc/h.

The parameters measured at the extraction point and at the monitoring points are summarized in the following tables.

#### SVE

Tempo minuti	Pid ppm	Lel %	O2 %	CO2 %	Depress mbar	V m/s	T °C	Q mc/h
<b>0</b>	480.1	18	21.3	1.22	-286.0	7.74	1.4	47
<b>10</b>	2147.0	16	21.5	3.45	-258.0	6.57	0.8	47
<b>30</b>	2371.0	13	20.9	3.16	-249.0	6.23	4	43
<b>60</b>	4106.0	13	20.9	2.7	-236.0	6.77	4.1	50
<b>90</b>	4469.0	10	20.9	2.26	-232.0	7.46	4.6	53
<b>120</b>	5000.0	10	20.9	2.08	-229.0	8.27	5.2	57
<b>180</b>	5000.0	9	20.9	1.83	-225.0	9.03	5.9	64
<b>240</b>	5000.0	9	20.9	1.62	-222.0	9.53	6.9	67
<b>300</b>	5000.0	8	20.9	1.44	-220.0	9.6	7	72

#### SVE old

Tempo minuti	Pid ppm	Lel %	O2 %	CO2 %	Depress mbar
<b>0</b>	1824.0	47	21.3	4.99	0.0
<b>10</b>	1867.0	40	21.5	4.99	0.0
<b>30</b>	2042.0	27	20.9	4.39	0.0
<b>60</b>	2015.0	27	20.9	3.81	-0.9
<b>90</b>	1140.0	2	20.9	0.04	-7.5
<b>120</b>	285.9	2	20.9	0.07	-15.0
<b>180</b>	211.6	0	20.9	0.04	-20.0
<b>240</b>	112.7	0	20.9	0.04	-22.0
<b>300</b>	93.6	0	20.9	0.07	-24.0

#### SGS1

Tempo minuti	Pid ppm	Lel %	O2 %	CO2 %	Depress mbar
<b>0</b>	544.3	0	21.3	4.99	-5.8
<b>10</b>	261.1	5	21.5	4.99	-6.5
<b>30</b>	61.3	2	20.9	0.07	-7.0
<b>60</b>	266.0	0	20.9	0.07	-7.5
<b>90</b>	125.5	4	20.9	2.05	-8.5
<b>120</b>	93.2	0	20.9	1.62	-9.5
<b>180</b>	88.5	0	20.9	1.65	-9.5
<b>240</b>	73.2	0	20.9	1.11	-10.0
<b>300</b>	73.8	0	20.9	1.25	-10.0



<b>SGS2</b>						<b>SGS3</b>					
<b>Tempo</b>	<b>Pid</b>	<b>Lel</b>	<b>O2</b>	<b>CO2</b>	<b>Depress</b>	<b>Tempo</b>	<b>Pid</b>	<b>Lel</b>	<b>O2</b>	<b>CO2</b>	<b>Depress</b>
minuti	ppm	%	%	%	mbar	minuti	ppm	%	%	%	mbar
<b>0</b>	1872.0	14	21.3	4.99	-6.6	<b>0</b>	4852.0	9	21.3	0	0.0
<b>10</b>	2492.0	20	21.5	11	-16.0	<b>10</b>	5000.0	5	21.5	0	0.0
<b>30</b>	2030.0	16	20.9	4.82	-22.0	<b>30</b>	3866.0	4	20.9	0	0.0
<b>60</b>	2550.0	14	20.9	4.53	-36.0	<b>60</b>	4670.0	5	20.9	0.04	0.0
<b>90</b>	2903.0	11	20.9	4.1	-38.0	<b>90</b>	5000.0	4	20.9	0	0.0
<b>120</b>		10	20.9	3.67	-39.0	<b>120</b>	5000.0	4	20.9	0	0.0
<b>180</b>					-41.0	<b>180</b>	5000.0	0	20.9	0	0.0
<b>240</b>					-43.0	<b>240</b>	5000.0	0	20.9	0	0.0
<b>300</b>					-45.0	<b>300</b>	5000.0	0	20.9	0	0.0

The missing data are due to the presence of condensation in the pipes that did not allow the use of the instrumentation.

Data analysis:

- the Pid highlights the increase in values at the SVE point and the simultaneous decrease in the monitoring points, in accordance with the recall of contaminants at the suction point;
- the Lel decreases in all points;
- oxygen stabilizes at 20.9%;
- carbon dioxide shows a tendency to decrease over time;
- the depressions show a greater response to pumping in SGS2 than in SGS1, closer to the SVE point, probably due to the conformation of the subsoil in the area in question; in point SGS3 there are no effects induced by pumping.

During the test, due to local conditions, the extracted flow rate varied from 47 mc/h (set at the beginning) to approximately 70 mc/h. With this capacity, considering what is highlighted by the data, the effects of the vacuum induced by pumping can be observed in the control points SVEold, SGS1 and SGS2 while the point SGS3 does not show variations. The range of influence, therefore, is between 4 and 8 m.

### 3.3 Radius of influence

During the pilot test, performed by sucking air from the central point called SVE, the induced depressions in the monitoring points, called SVEold, SGS1, SGS2 and SGS3, were measured and arranged as illustrated in par. 3.1. The effects of the vacuum induced by pumping are observable in the control points SVEold, SGS1 and SGS2 while the point SGS3 shows no variation. The range of influence, therefore, is between 4 and 8 m.



### 3.4 Off gas Treatment

In the SVE point, an extraction system with an activated carbon filter was installed.

### 3.5 Control parameters

During the pilot test, as reported above, the following parameters were monitored with field instruments:

- VOC (volatile organic compounds) of interstitial gases with the use of a Portable Photo ionizer (PID);
- concentrations of oxygen, carbon dioxide, LEL (Lower Explosive Limit) of interstitial gases with a portable IR instrument;
- depressions induced by the rotary blower with a digital pressure gauge (thermo anemometer).

The recorded data made it possible to identify the air permeability of the soil and the range of influence of the suction system sized for a suction point.

## 4. Full-scale application

### 4.1 Extraction system

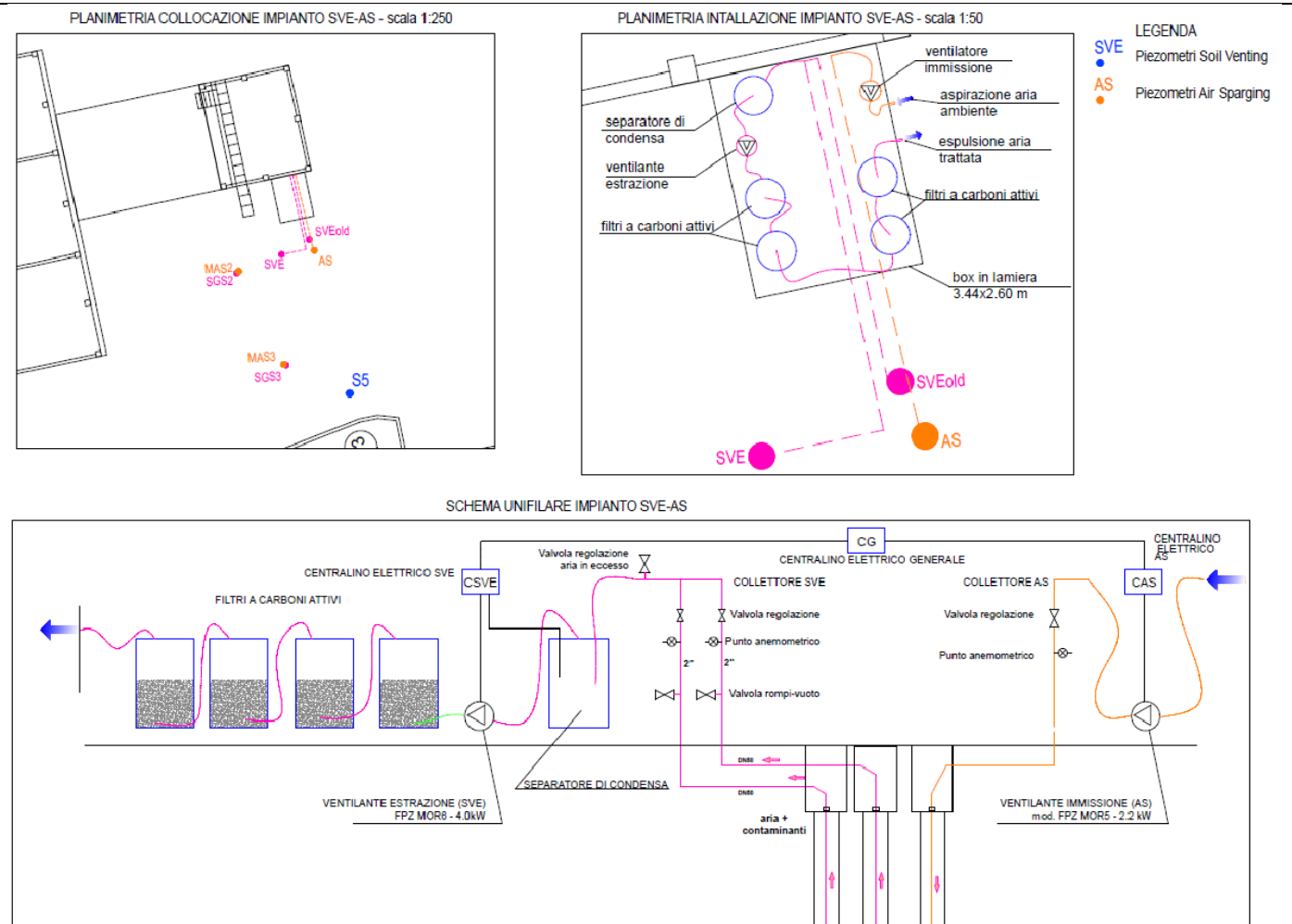

The plant and its monitoring were started on 14/03/2019.

On the basis of the pilot test performed, it was assumed, as a precaution, a range of action equal to 4 m for the SVE point; consequently it was decided to equip two points for the extraction of vapours, namely the point called SVE and the point called SVEold. During the work, specific calibration tests will be conducted in order to set the optimal configuration for the system.

The SVE and SVEold extraction wells made have the following characteristics:

- drilling up to 4 m deep;
- installation of piezometer (diameter 3"), depth 4 m, fenestrated between -1 and -4 m from the ground floor;
- cementation from p.c. at -1 m;



- installation of calibrated siliceous gravel from –1 m to –4 m from p.c.

The wellhead of the vertical intake is connected to the manifold, mounted at the plant box, which is connected to the separator and subsequently to the aspirator and filter (see image below, which also indicates the Air Sparging system).

### 4.3 Radius of influence

Based on the monitoring of the lowering measured during the pilot test at the control points (SVEold, SGS1, SGS2 and SGS3) the influence range is between 4 and 8 m; consequently, as a precaution, a radius of influence equal to 4 m was considered.

### 4.4 Off gas Treatment

Activated carbon filter

Downstream of the suction system, two containers of activated carbon weighing about 50 kg each were placed in series.

### 4.5 Control parameters

In order to monitor the effectiveness of the SVE/AS system, periodic monitoring of the system and sampling of interstitial gases has been prepared.

With regard to the monitoring of the plant, a fortnightly frequency of checks has been established during the first 2 months of activity, monthly up to 6 months, and quarterly up to 12 months of plant activity. During the checks, measurements of the main flow parameters of the system are carried out with field instruments capable of determining air flow (anemometer), temperature, VOC concentration (PID), differential pressure between the fixed probes in the ground and the atmosphere (Magnehelic).

Samplings of soil gases by means of activated carbon vials were also provided. On 14/03/2019 "zero" sampling took place, coinciding with the start-up of the plant. A further 4 samplings were scheduled during the 12 months of reclamation, foreseen by the project.



## 5. Enhancements to SVE

### 5.1 Pneumatic and/or hydraulic fracturing

As mentioned above, an AS (Air Sparging) plant was associated with the SVE for the treatment of groundwater underlying the site. The plant consists of a piezometer, for the injection of atmospheric air into the groundwater, with a depth of 9 m. Three piezometers (called MAS1, MAS2 and MAS3) were also created at a distance of 3, 6 and 9 m from the first one for the introduction of air, as monitoring points. The latter were carried out at the points provided for the monitoring of soil gases (SGS), within the same drilling, in such a way as to optimize economies.

## 6. Post treatment and/or Long Term Monitoring

### 6.1 Post treatment and/or Long Term Monitoring

The monitoring plan provided for a sampling of soil gases upon activation of the plant and 4 samplings during the remediation. For the sampling of soil gases, activated carbon vials are used for the determination of C <12 hydrocarbons, with relative speciation, Benzene, Tetrachlorethylene, Trichloromethane and Trichloroethylene.



## 7. Additional information

### 7.2 Additional information

Initially, it was planned to carry out a test through soil sampling, after 12 months of treatment, to verify the state of contamination and evaluate any further actions. To date, the treatment of the land is still ongoing, since, following a failure of the plant which occurred in 2020, it was decided to extend the treatment for a further year. At the time of testing, soil samples must be taken from two cores carried out near point C8, at depths of 0-1 m and 2-3 m. The analytical set must include:  
Sample 0-1 m: C <12 hydrocarbons, with relative speciation, Benzene, Tetrachlorethylene  
Sample 2-3 m: Trichloromethane, Trichloroethylene.

## Glossary of Terms

<b>Term (alphabetical order)</b>	<b>Definition</b>
SIN	Contaminated site of national priority list
PA	public administration

## 1. Contact details - CASE STUDY: SVE n.18

<b>1.1 Name and Surname</b>	Massimiliano Confalonieri – Valter Meda
<b>1.2 Country/Jurisdiction</b>	Italy
<b>1.3 Organisation</b>	Agenzia Regionale per la Protezione dell’Ambiente (ARPA) della Lombardia
<b>1.4 Position</b>	Dirigente RUO BARAE – Tecnico UO BAE MI-MB
<b>1.5 Duties</b>	
<b>1.6 Email address</b>	<a href="mailto:m.confalonieri@arpalombardia.it">m.confalonieri@arpalombardia.it</a> <a href="mailto:v.meda@arpalombardia.it">v.meda@arpalombardia.it</a>
<b>1.7 Phone number</b>	+39 335 531 8045





## 2. Site background

### 2.1 History of the site

The area in question is located in the territory of the Municipality of Villasanta (Monza and Brianza province), north of the Milan urban area and is geographically located in the high Lombard plain, immediately south of the pre-Alpine moraine hills.

The site was affected by the presence of an industrial plant built in 1971 and dedicated to the production of air conditioning equipment. Industrial production has ceased but the site retains its industrial use and the area is occupied by commercial and/or logistics activities.

The main production cycles concerned:

- mechanical processing of metals;
- oven painting with organic solvent paints;
- electrophoresis painting.

Both painting processes, discontinued in 1994, were supported by a waste water treatment plant. The main structures present were made up of:

- a purification plant (decommissioned in 1994) with two masonry tanks, a settler and a sludge drying tank;
- a thermal power plant, currently fuelled by methane;
- 5 underground tanks located about 10 m from the south west corner of the thermal power plant, n. 4 of which containing fuel oil and n. 1 containing diathermic oil. All fuel oil tanks would have been removed in 1991 during the construction of the underpass. The diathermic oil tank was removed and replaced with a new double-walled tank positioned along the east side of the thermal power plant. This latter tank also seems to have been removed in 1992 with the construction of the thermal power plant;
- 2 electrical transformer cabins, one located in the thermal power plant and one inside body C. The one in the thermal power plant has a single transformer and is currently not in use, with a concrete containment tank in good condition. The one inside body C is in use. Transformers with PCB-containing oils were reclaimed and replaced in 1989

The site was affected by a remediation procedure according to the regional regulations in force at the time that began before the entry into force of the Ministerial Decree of 25 October 1999, n. 471. Later, the process has been developed according to the ordinary operational and administrative procedures laid down by Legislative Decree 3 April 2006, n. 152.

Since the area is not included in the case of SIN or SIR in implementation of the regional

delegations, the competent authority in charge of the administrative acts is the municipal administration.

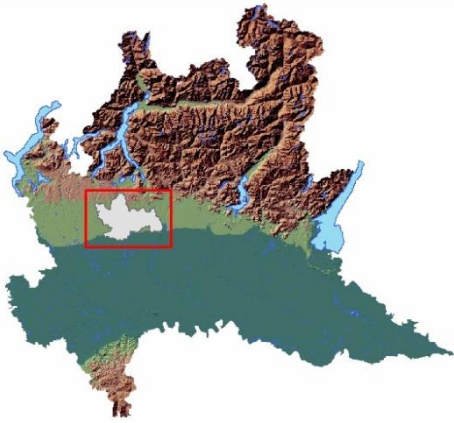

Lombardy – Monza Brianza Province

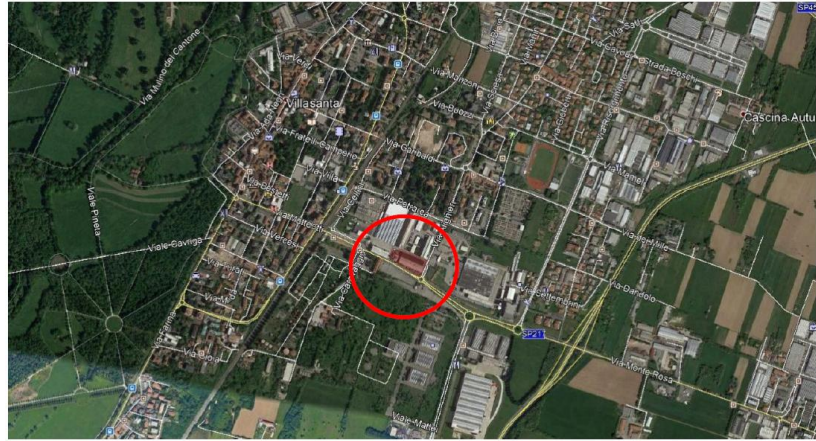

Villasanta – site location

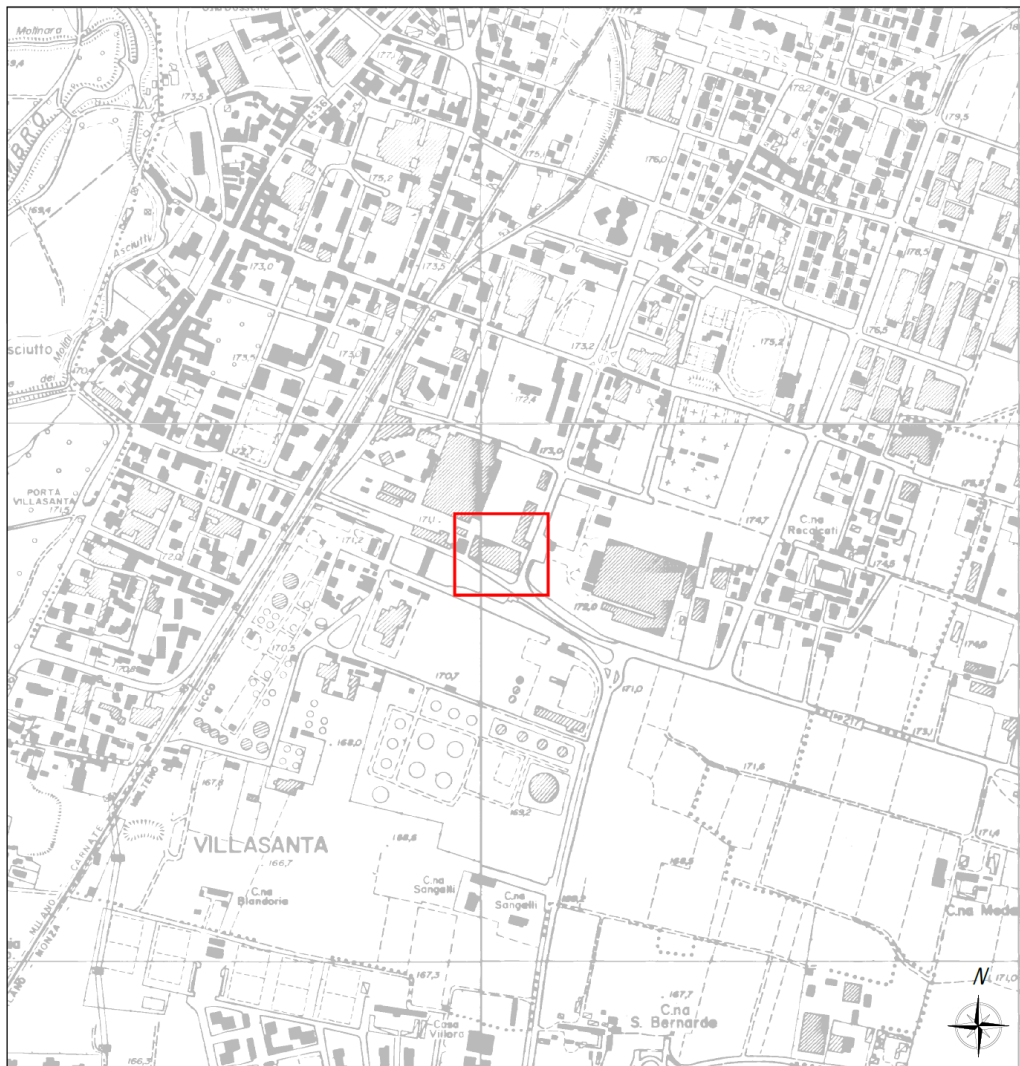

Base cartografica: Stralcio C.T.R. Regione Lombardia fogli B5c4, B5c5, B5d4, B5d5 scala 1:10.000 (mod)

Villasanta – site location (Technical Regional map 1:10:000)

## 2.2 Geological setting

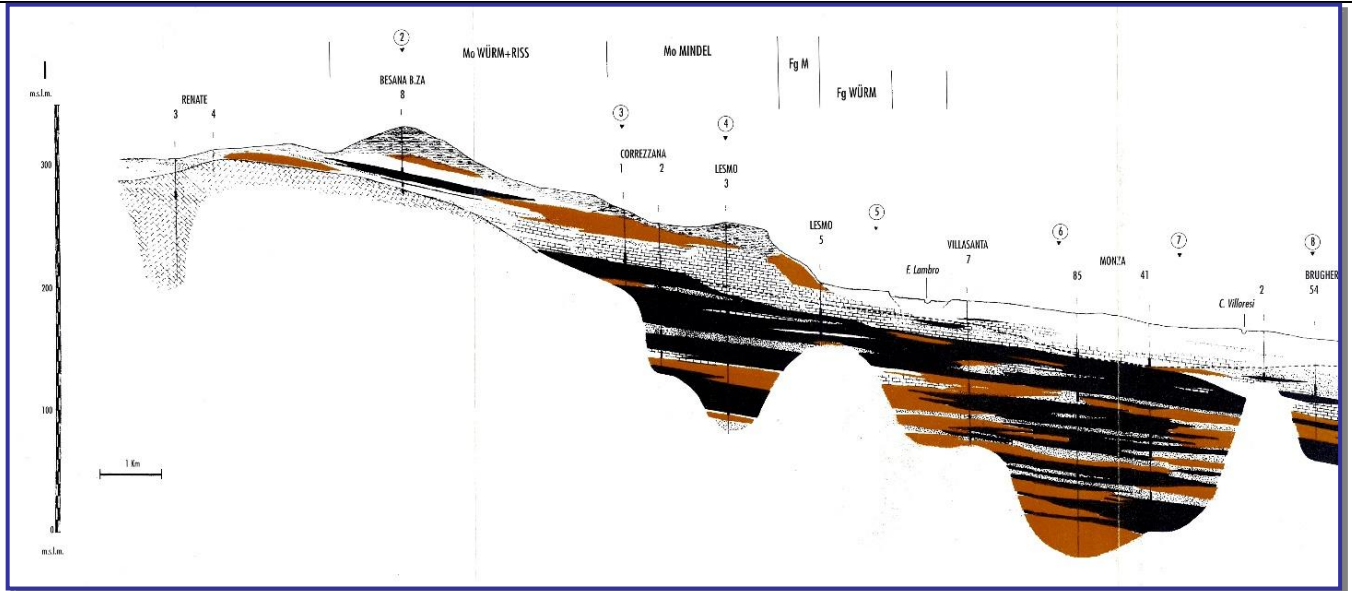

NS hydrogeological section of the central area and the Lambro basin (from: Provincia di Milano, 1995)

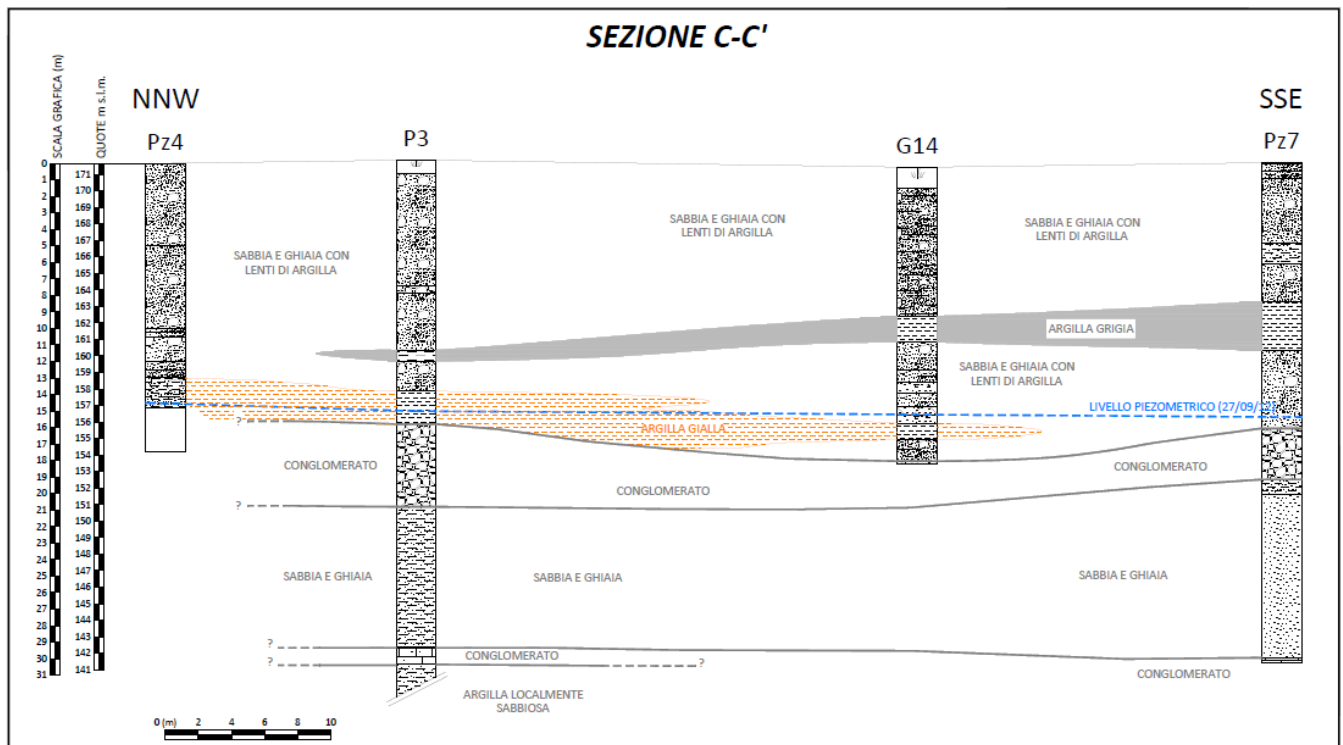

Stratigraphic detail of the intervention area

The western border of the municipal area coincides with the path of the Lambro river.

Geologically, the subsoil of Villasanta can be included within the Fundamental Level of the Plain (LFP), traditionally characterized by deposits of late Pleistocene fluvial-glacial origin, consisting of sands and gravels with pebbles that form the Lombard plain. Near the banks of the Lambro, more recent sediments develop which can be associated with the depositional activity of the watercourse itself. From a petrographic and lithological point of view, the origin of the Lambro deposits is strictly attributable to the portion of the pre-Alpine chain which, within the reference hydrographic basin, crops out in correspondence with the Larian triangle between Como and Lecco. This can be distinguished due to the outcrop of Mesozoic geological units of a predominantly calcareous nature.

The presence of the Lambro river also affects the alluvial sediments, whose deposition over time has given rise to real paleo-riverbeds with high transmissivity values.

In general, in the area under examination, the subsoil is characterized in the superficial portion by the presence of mainly gravelly-sandy lithology horizons, with high permeability and thickness values. Proceeding in depth, the progressive lithological variations due to the prevalence of fine-textured lithologies (clays, silts and fine sands) determine a reduction in permeability. Under these conditions, the aquifer horizons are limited to isolated lenses of relatively permeable material and of modest thickness. The hydrogeological structure traditionally described by authors on the basis of the permeability characteristics has led to the identification of three main hydrostratigraphic units having the following characteristics:

- first aquifer: consisting of prevailing gravels and sands, with subordinate fractions of silts and gravelly-sandy horizons locally cemented. These sediments can be traced back to the recent and ancient alluvial and fluvioglacial deposits from Würm (upper Pleistocene) which constitute the Fundamental Level of the Plain (LFP). This unit contains the upper part of the traditional aquifer, characterized by relatively high hydraulic conductivity values between  $10^{-3}$  and  $10^{-4}$  m/s. The characteristics of the aquifer are those typical of a free, unconfined water table;
- second aquifer: consisting of gravels and silty sands and conglomeratic horizons. These lithotypes are traditionally attributed to the ancient fluvioglacial deposits of Mindel and Riss (lower Pleistocene) which on the surface give rise to the characteristic “ferretto” terraces of the foothills and hills of Brianza. The permeability of the aquifer which has hydraulic conductivity values of an order of magnitude lower than those of the first aquifer and equal to about  $10^{-4}$ - $10^{-5}$  m/s. This aquifer can contain a free aquifer or, in the presence of horizons that are not very permeable to the roof, locally semi-confined, generally in connection with the one above. Where the piezometric load differences between the two aquifers are more significant, water exchanges between the aquifers may occur due to the phenomenon of drainage;



- third aquifer: characterized by predominantly fine-textured soils, such as silts and clays with fine sand levels. These deposits are attributed in literature to the so-called Villafranchian clays. Due to the clear prevalence of fine-grained lithotypes, the hydraulic conductivity values in sandy lenses are approximately  $10^{-4}$ - $10^{-6}$  m/s. The sandy lenses themselves are home to confined and protected aquifers.
- In the area of Monza and Villasanta the hydrogeological characteristics of the subsoil are particularly different compared to the adjacent areas, in particular due to the presence of a high structure (Monza ridge) which causes the Villafranchian substrate to rise with a consequent reduction in the thickness of the aquifers. This hydrogeological situation makes it possible, in the sector east of the Lambro river, to interconnect the first and second aquifers with consequent possible mixing between contaminated aquifers and good quality aquifers.

The superficial aquifer (groundwater) is contained in the sediments that form the gravelly-sandy-silty unit and the conglomeratic unit (Ceppo auct.). As already mentioned, the two units are only locally separated by semi-permeable deposits which can give rise to differences in the piezometric level, although, in general, compared to the adjacent western area, the traditional aquifer is substantially undifferentiated. In the area under examination (Villasanta) the presence of a suspended aquifer supported by a discontinuous silty-clayey lens and contained in deposits with a prevalently gravelly-sandy texture was also ascertained.

## 2.3 Contaminants of concern

The site is characterized by the presence of contamination:

### Soil and subsoil

The characterization investigations on the entire site have shown overall compliance with the CSCs envisaged for the specific intended commercial and industrial use.

On the basis of historical investigations and analyses carried out by means of soil gas survey, the presence of tetrachlorethylene was ascertained in the entire horizon thickness unsaturated underlying the building in which the main painting cycles and degreasing of materials was carried out.

The figure below shows the values measured in the interstitial gases during the characterization phase and before the application of the SVE technology.

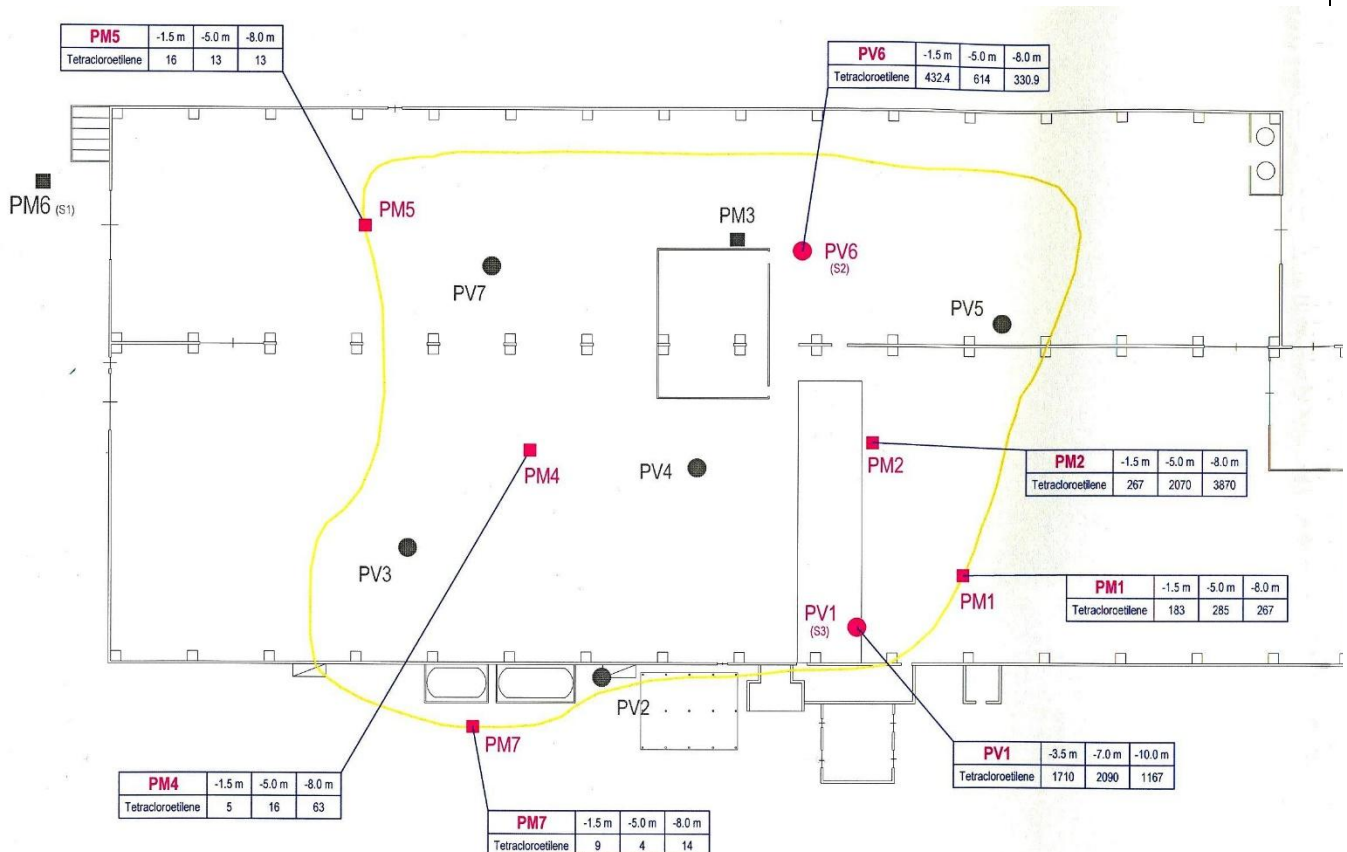

### Groundwater

Contamination of the groundwater in the area is essentially and almost exclusively due to tetrachlorethylene (PCE), with associated low concentrations of trichloroethylene (TCE) and chloroform (TCM). The presence of this substance in concentrations up to

400 times the CSC is well above the background value that is generally found in most of the area north of Monza and which roughly corresponds to the values found "at the entrance" to site, in the hydrogeologically upstream piezometer, between 6.5 and 48µg/l.

High concentrations were detected in 2002 throughout the south-eastern portion of the plant, in correspondence with some wells, with values up to 473 µg/l. The origin of the contamination has been traced back to the washing and degreasing of pieces using PCE, a solvent stored in underground tanks present in the building subject to the renovation.

CodiceSIF	denonint	data	PCE
0152390026	Well 3	11-mar-04	180
		14-set-04	198
		07-apr-05	61.14
		23-mar-06	28.7
		22-mag-07	286
		25-lug-08	340
0152390043	Well 5	11-mar-04	28
		14-set-04	168
		07-apr-05	27.6
		23-mar-06	22.2
		22-mag-07	22
		25-lug-08	7.5
0152390054	Pz 1 (upgradient)	11-mar-04	48
		14-set-04	39
		07-apr-05	21.7
		23-mar-06	8.6
		22-mag-07	6.5
		25-lug-08	6.7
0152390065	Pz 2 (downgradient)	11-mar-04	11
		14-set-04	19.37
		07-apr-05	3.99
		23-mar-06	5.8
		22-mag-07	4.2
		25-lug-08	4.2
0152390066	Pz 3 (upgradient)	11-mar-04	4.6
		14-set-04	3.2
		07-apr-05	3.04

0152390067	Well 6 (pumping well)	23-mar-06	4.69
		22-mag-07	7.1
		25-lug-08	0.7
		11-mar-04	200
		14-set-04	213
		07-apr-05	64.32
		20-mar-06	42.29
		22-mag-07	38.6
		25-lug-08	320

The map shows the points of the monitoring network in the configuration active in 2010

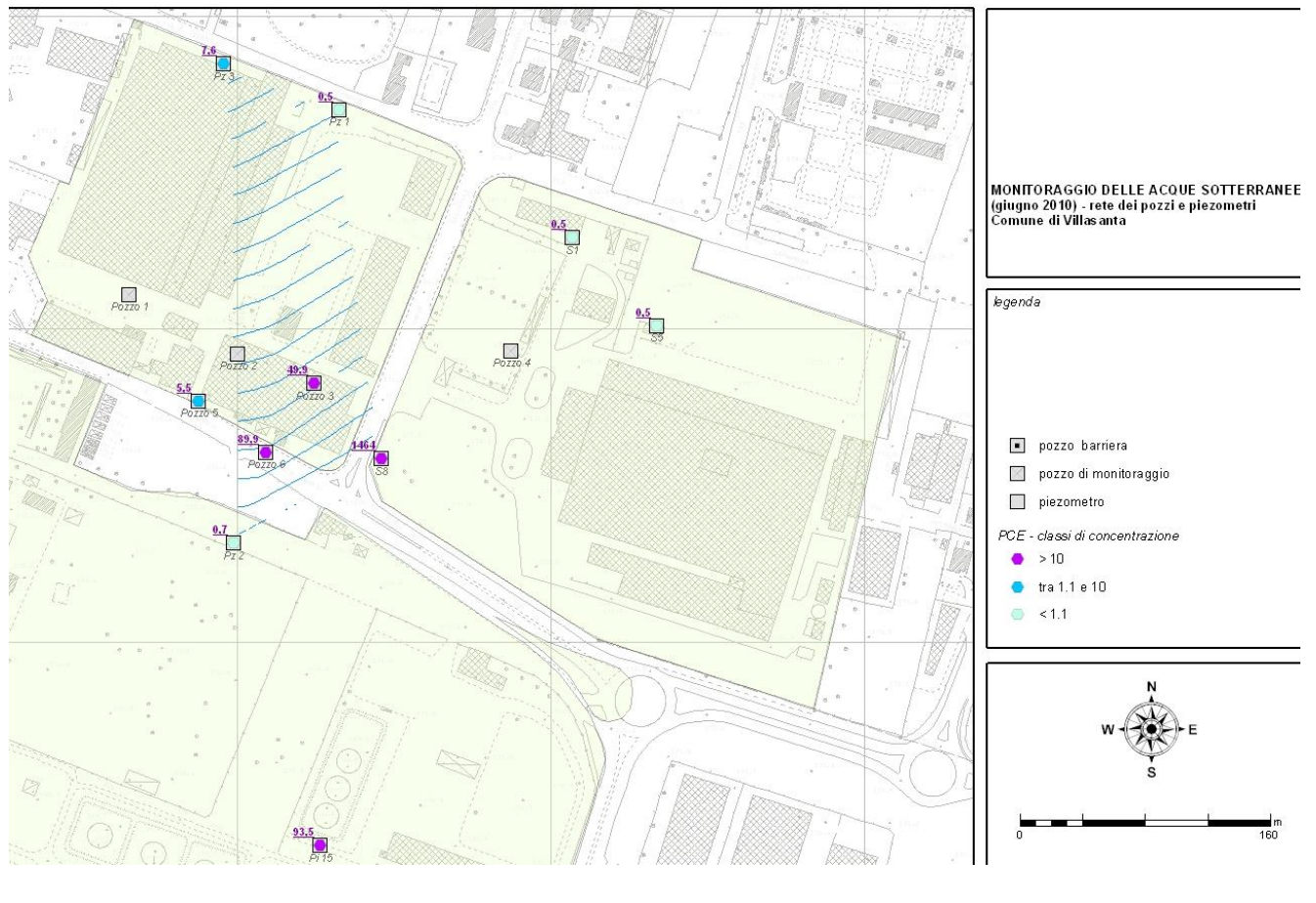





## 2.4 Regulatory framework

The remediation process of the area had been started before the national legislation on the remediation of contaminated sites came into force (Legislative Decree 22/97 and Ministerial Decree 417/99), applying the reference standards already existing in the Lombardy Region before 1997.

During the verification of the interstitial gases carried out at the building called "former Battery Department" or "former Building B", located in the south-east portion of the plant, the presence of PCE was detected in the interstitial gases and in excess concentrations to the regulatory limits even in groundwater.

In light of this, the company has sent its notice pursuant to dell' art. 242, paragraph 1 of Legislative Decree 152/06 to the competent local authorities in February 2011.

Following this communication, the Characterization Plan of the area on which the former Building B stands was drawn up and sent to the Authorities, subsequently approved in the Conference of Services in May 2011 by the competent Authority.

In July-August 2012 a new interstitial gas sampling campaign was carried out; with the results obtained, relative to the PCE concentrations, it was possible to redefine the spread of contamination in the subsoil, the starting point for the elaboration of the Risk Analysis.

The site-specific Health and Environmental Risk Analysis document was favourably assessed with prescriptions by the Authorities during the Service Conference in October 2012.

Therefore, in 2012 an additional document with acceptance of Conference of Services prescriptions that defines the CSR for soil gas and groundwater as remediation targets was prepared.

Following approval of the remediation objectives, equal to 71 mg/m<sup>3</sup> of PCE in soil gas for the unsaturated portion of land, a remediation project of the total subsoil was drawn, which also included the portion of the aquifer assessed in the Conference of Services in March 2013 with related observations and additions by the Authorities.



## 3. Pilot-scale application in field

### 3.1 Extraction system

The technology applied for the remediation of the area consisted of the combination of an extraction plant (SVE) for unsaturated soil, associated with an Air-Sparging (AS) plant for the remediation of groundwater (saturated).

In consideration of the geological-stratigraphic structure of the soil, characterized by the alternation of horizons with coarse and medium fine textures, the design of the SVE plant was carried out on the basis of data already available on site, having been active in a network of wells for interstitial gas measurement.

For the correct sizing of the AS system, a pilot module was instead prepared.

In relation to the local stratigraphic succession and in particular to the presence of clay lenses in the area to be reclaimed, the overall system of SVE and AS was created with the following characteristics:

- n. 18 suction wells of which:
  - n. 5 "shorts" (PV1, PM2, PV6, VW14 and VW15) → with filtering section between pc and the roof of the first clay lens, used for the remediation of unsaturated soil, possibly still polluted.
  - n. 7 "intermediate" wells (VW1 - VW7) → with filtering section between the first and second clay lens, necessary to concentrate the recall of polluting vapours in this area, where the effect of AS will be greater and where the vapours will concentrate;
  - n. 6 "long" wells (VW8 - VW13) → with filtering section between 6 and 14-15 m deep, or in any case one meter above the height of the phreatic surface, will instead have the function of area limiting the diffusion of the AS effect and treat the vapours deriving from the groundwater.
- n. 6 insufflations wells (AS1 - AS6) located inside the former Battery Department, in the area of maximum PCE concentration in interstitial gases. In the pilot scale application, the construction of a well for insufflations of groundwater (AS/G14) and n. 6 monitoring wells positioned around the AS;
- n. 2 SVE systems, consisting of a condensate separator, a side channel aspirator and an activated carbon filter, of which:
  - plant 1 to which the "short" wells are connected;
  - plant 2 to which the "intermediate" and "long" wells are connected;
- n. 1 AS system consisting of a blower in correspondence with each AS well, capable of blowing air at the established flow rates and pressures.
- n. 3 monitoring wells, necessary especially in the initial start-up phase, to check the

influence rays of the venting wells.

The system was initially launched in the pilot phase and after two months, once the functional and monitoring data of the system itself had been acquired, it came into operation at full capacity.

The data collected during the monitoring made it possible to regulate flows and depressions of the plants. The results obtained from monitoring with colorimetric vials, on the other hand, gave a more precise indication of the presence of PCE in interstitial gases. Over time, the outermost wells were closed, particularly in the westernmost area where the PCE values were zero, in order to concentrate the area of influence of the SVE in the most critical areas.

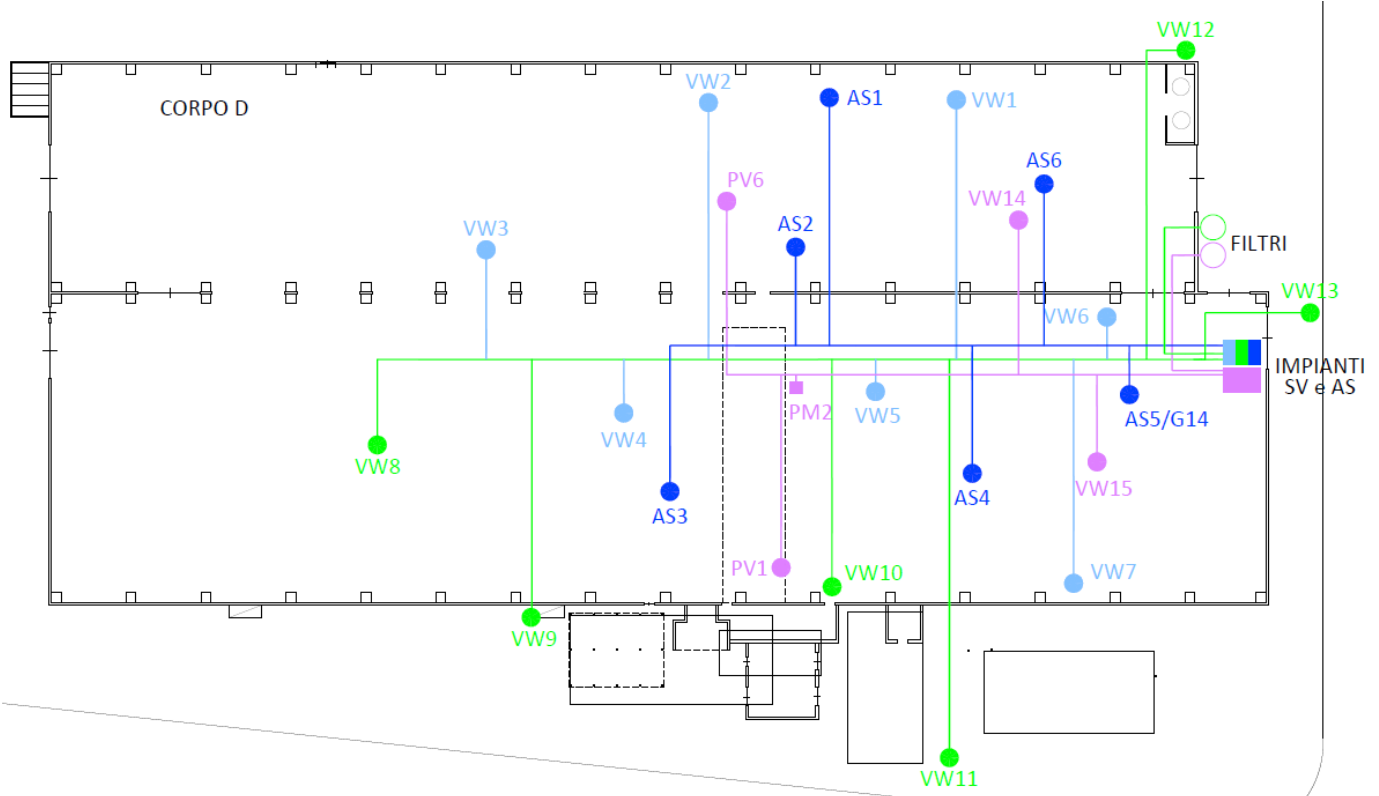

Position of the AS and SVE wells

## 3.2 Injection system

The AS plant was divided into n. 6 insufflations wells (AS1 - AS6) located in the area of maximum PCE concentration in interstitial gases.

In the pilot scale application, a well for insufflation of groundwater (AS/G14) and n. 6 monitoring wells were constructed positioned around the AS.

The carrier gas used was air, injected through diffusers to maximize the flow and increase the area exposed to the treatment. Thanks to the diffusion of high air flow, distribution was homogeneous in the contaminated area and the stripping effect of the volatile contaminants (PCE) from groundwater which are then extracted by SVE was amplified.

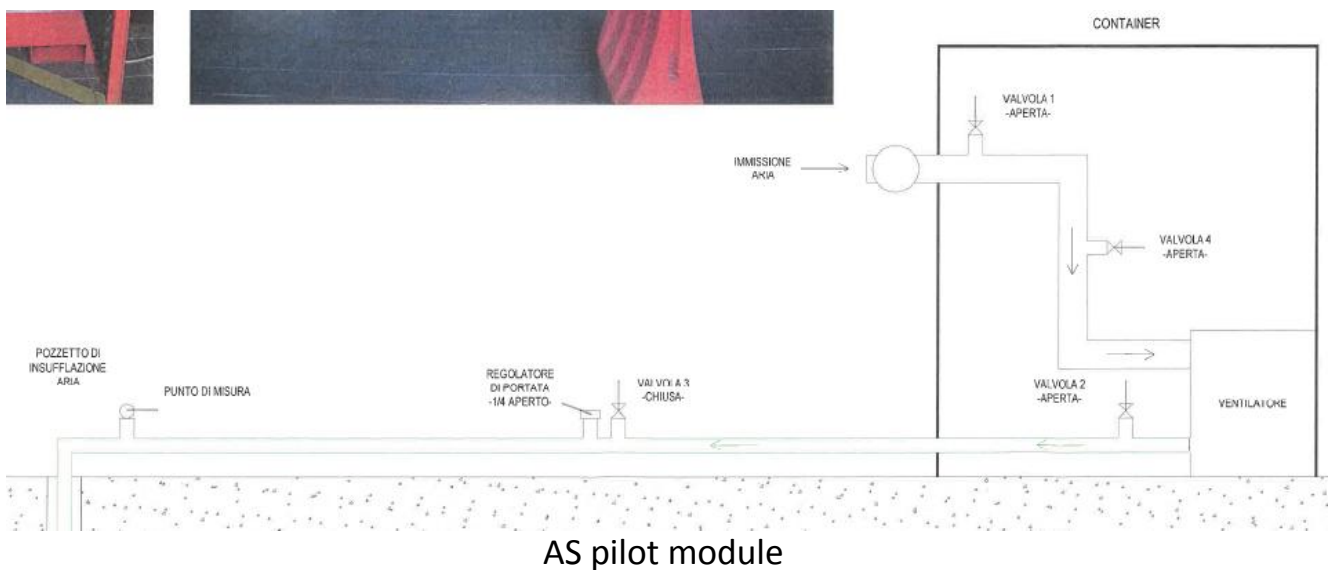

### 3.3 Radius of influence

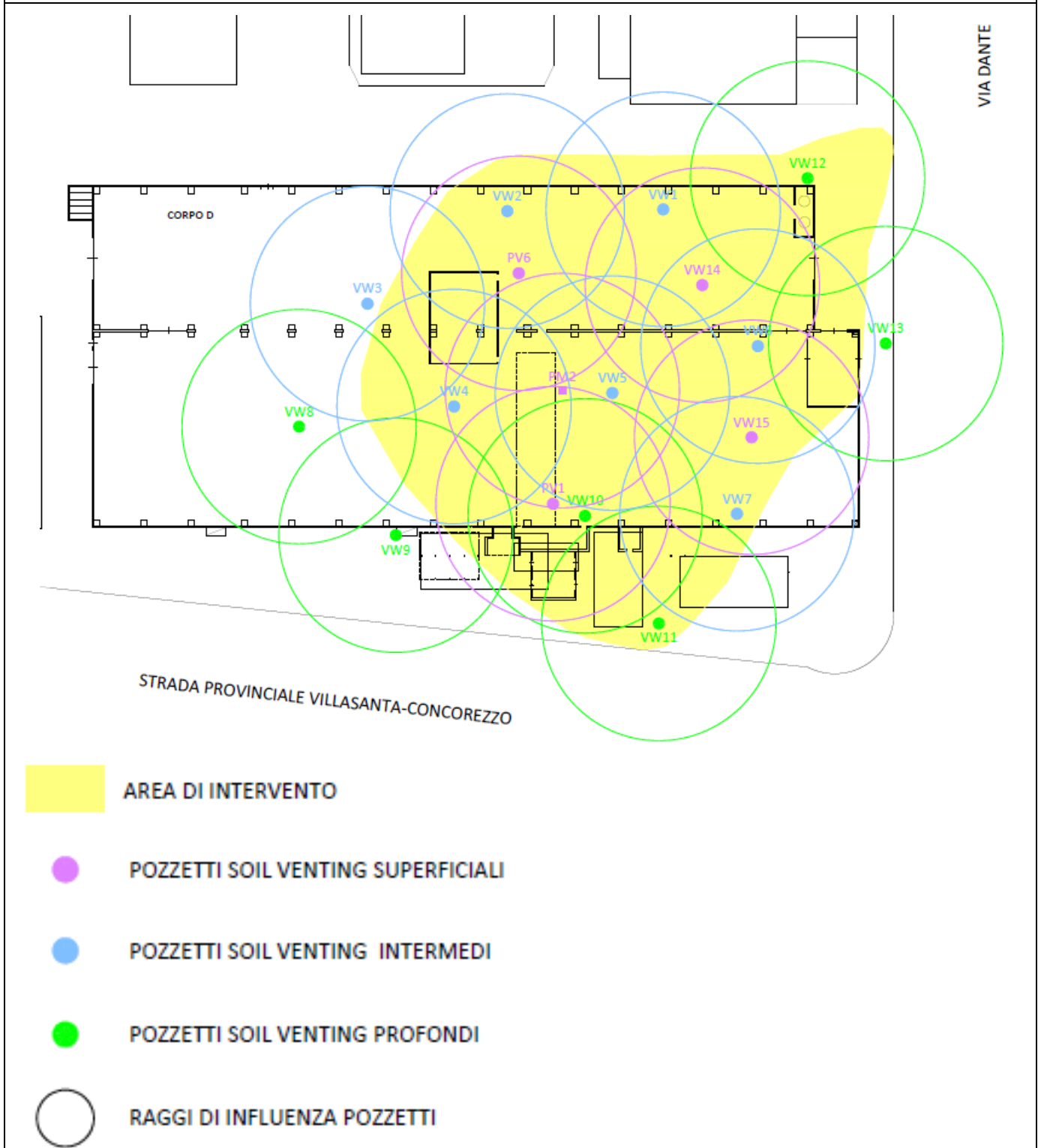



On the basis of the bibliographic data already present for the site and in particular those derived from the implementation of the previous reclamation project, from the stratigraphic observations carried out during the investigations and from the pilot test carried out and described in the previous chapter, it was possible to hypothesize a range of influence for each suction pit equal to 15 m.

The location of the suction points has been selected in such a way that the respective rays of influence are sufficiently coalescing and there are no unaffected areas within the area to be reclaimed.

### **3.4 Off gas Treatment**

As a real pilot phase was not foreseen for the development of the SVE system (it should be remembered that there was a monitoring system of interstitial gases built in application of regional legislation on site for some time and before the planning of the reclamation interventions), the gaseous effluent treatment system corresponds to that envisaged by the operational reclamation interventions when fully operational.

In this regard, see the answer to question 4.4

## 4. Full-scale application

### 4.2 Injection system

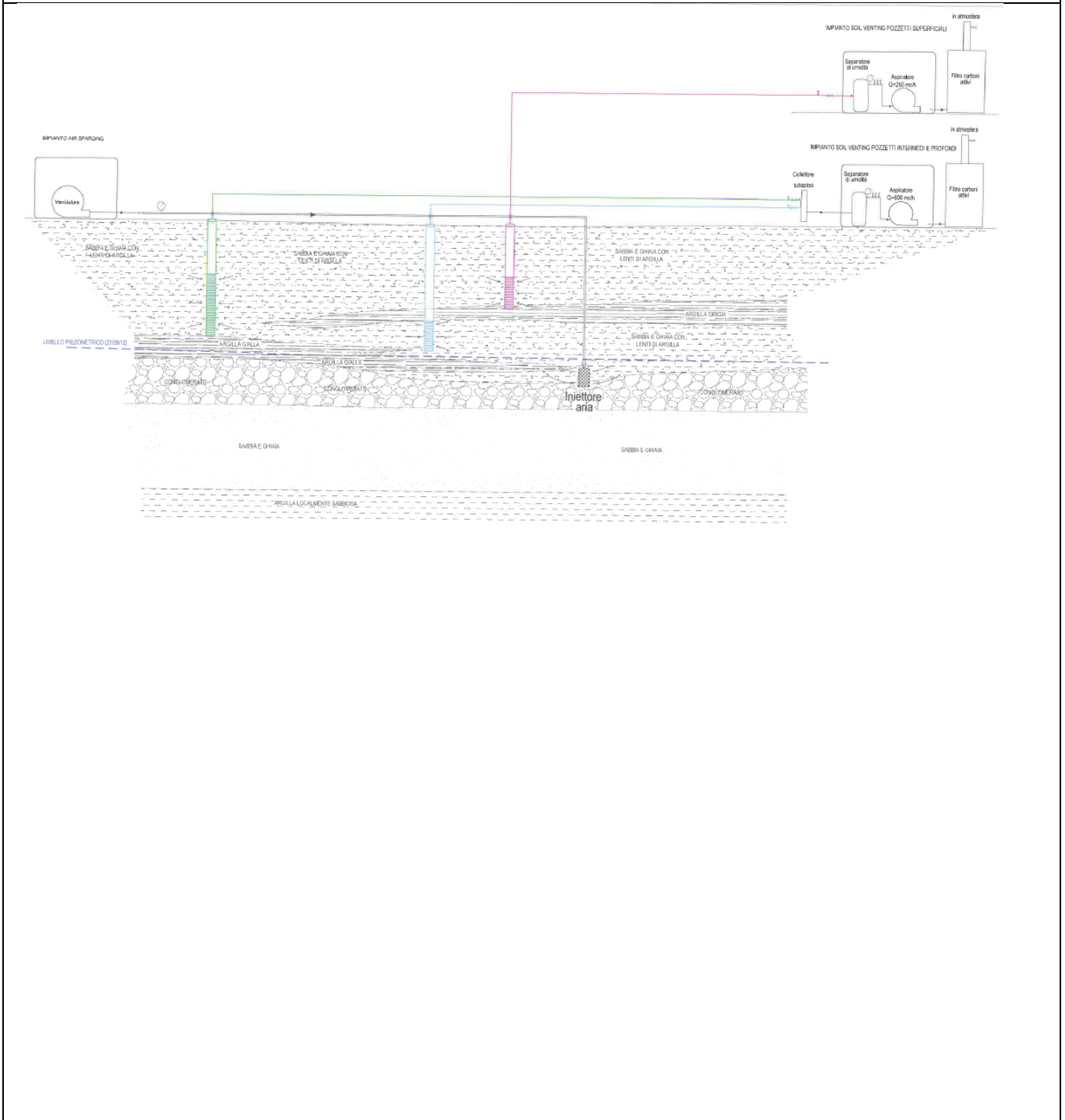



## 4.4 Off gas Treatment

Based on the characteristics and functions of the wells, these were connected to two separate suction systems integrated with attached activated carbon filters.

The vapours deriving only from the "short" suction wells with an indicative flow rate of 250 m<sup>3</sup>/h were collected in plant 1.

The vapours deriving from the "intermediate" and "long" suction wells were collected in plant 2 with a total suction flow rate of 650 m<sup>3</sup>/h (approximately 50 m<sup>3</sup>/h for each suction well).

A condensate separator was provided prior to the connection to the activated carbon filter.

The following are the characteristics of the activated carbon filter:

- Estimated gas flow: 650 m<sup>3</sup>/h;
- Filtering surface: 3.0 m<sup>2</sup>;
- Filter material volume: 7.0 m<sup>3</sup>/h;
- Contact time: 38.77 s;
- Filtration speed: 0.06 m/s;
- Active carbon quantity: 4,000 kg;
- Filter layer height: 2,800 mm;
- Inlet/outlet pipe diameter: 100 DN





## 4.5 Control parameters

Describe the monitoring plan designed to evaluate the effectiveness of SVE in the three dimensions. List the control parameters considered.

The direct verification of the radius of influence of the venting wells was carried out through 3 monitoring wells with a depth of 8 m from a pc, equipped with a 2 "PVC pipe, blind for the first 2 m and micro-slotted at -2 m at the bottom of the hole. The perforation-pipe cavity was filled with selected silicon gravel in the micro-cracked sections and with cement/bentonite grout in the blind top sections.

The monitoring operations include both on-site analyses, using portable instrumentation, and laboratory gas chromatographic analyses, by taking air samples from activated carbon vials, in order to calibrate the analyses performed on site.

The following parameters were determined on site, both refer to the entire system (measurement point at the collector) and to the individual wells:

- Air speed (m/s) by means of hot wire anemometer;
- Air temperature (° C) by means of a thermo hygrometer;
- Air humidity (%) by means of a thermo hygrometer;
- Depressions realized in the suction wells (mbar) by means of a digital manometer;
- SOV concentrations present in the air stream (ppm) by PID;
- PCE concentrations (ppm) through the use of colorimetric vials of suitable Gastec or similar scale, through sampling at the suction points.



## 6. Post treatment and/or Long Term Monitoring

### 6.1 Post treatment and/or Long Term Monitoring

The system was launched on October 8, 2013; the start-up phase took place in the following two months, during which the SVE and AS plants were activated by successive steps. From 4 December 2013, the plants operated at full capacity until 2 October 2017. During the entire period of operation of the reclamation plants, the functionality checks of the plants themselves and the monitoring of interstitial gases were regularly carried out in correspondence with the SVE wells.

The data collected during the monitoring made it possible to regulate flows and depressions of the plants.

The results obtained from the monitoring with colorimetric vials, on the other hand, gave a more precise indication of the presence of PCE in interstitial gases. Over time the outermost wells were closed, particularly in the westernmost area, where the PCE values were zero, in order to concentrate the area of influence of the SVE in the most critical areas.

As described in the last Technical Report drawn up in August 2017 before the shutdown of the plants, from the results of the monthly monitoring, it was found that:

- in a large area of that subjected to remediation, including the west, north-central and south-east corner, the PCE values in the measured soil gases reached concentrations close to or equal to zero, starting from July 2014;
- the wells located in the two limited areas of the central-eastern (VW6, VW13, VW14) and central-southern (VW10, VW11) zones also had values below the limit of 10.47 ppm of PCE and close to zero.
- the only point where the PCE was found in concentrations in soil gases close to the reclamation objective, was the VW12, located north-east of the former Battery Department;
- in correspondence with this well, sampling was then carried out by means of ac vials and laboratory analyzes. The analytical data confirmed compliance with the limits set downstream of the risk analysis.

Given the trends in PCE concentrations in the monitored SVE wells, in October 2017 the plants were shut down and the first phase of soil testing was started, by carrying out n. 2 on/off cycles of the systems to check for any rebound phenomena.

As indicated in the act of approval of the subsoil remediation project for the Carrier plant in Villasanta, the remediation objectives for the unsaturated soil matrix can be considered achieved when "... the results of the interstitial gas tests will attest to concentrations lower than 71 mg/m<sup>3</sup> of PCE in all the monitoring wells for at least two



campaigns carried out in different seasonal climatic conditions... "

The first test of unsaturated soil was carried out in 2018 with the two semi-annual sampling campaigns in June and November.

Given the negative results obtained during the second sampling in November 2018, the SVE plants were restarted until April 2019 for a total period of about 5 months and then the absence of rebound phenomena was verified through ignition/shutdown cycles.

The second phase of testing of unsaturated soil was therefore launched, carried out with the two six-monthly samplings respectively in July 2019 and January 2020. The results of the activities carried out in the two testing campaigns certified compliance with the authorized remediation objectives.



## 7. Additional information

### 7.1 Lesson learnt

The interventions that affected the site were carried out by an American multinational which, in line with its corporate policy, paid particular attention in terms of financial resources in the choice of the best performing remediation technology for the type of pollution (PCE) and for the particular site specific conditions (contamination of the unsaturated and saturated, with the presence of more contaminated horizons).

The use of interstitial gas sampling techniques and identification of remediation objectives with concentrations referring to the aeriform matrix present in the unsaturated soil represents one of the first cases of application in Lombardy (the first sampling had already been carried out before 2010, in the absence of guidelines and regulatory guidelines).

It is therefore a reference case study for the development of the pore gas measurement methodology that has been progressively implemented.

The SVE technology, associated with an AS plant and a Pump & Treat system, has been found to be effective in reducing the level of contamination present in the soil and groundwater.

At the administrative level, it is necessary to highlight the difficulties in defining the remediation objectives, considering that the legislation and technical guidelines in force at the time made the use of values in interstitial gases as a reference for site certification with little applicability.

From a technical point of view, it should be noted that the first soil characterization carried out with traditional techniques (sampling of soil by continuous core drilling and laboratory analysis) did not show that the table limits were exceeded, underestimating the actual state of contamination of the site.

The use of data from the measurement of interstitial gases in the second phase of characterization, however, made it possible to ascertain an effective contamination of the unsaturated soil, identifying at the same time the secondary source responsible for the contamination in the groundwater.



## Glossary of Terms

<b>Term (alphabetical order)</b>	<b>Definition</b>
VOC	Volatile organic compounds
SIN	Contaminated site of National Priority List
SIR	site of regional importance
CdS	Conference of Services
CSC	Contamination Threshold Concentrations
CSR	Risk Threshold Concentrations
SVE	Soil Vapor Extraction
AS	Air Sparging
PCE	Perchloroethylene (= Tetrachloroethylene)
TCE	Trielin (= Trichloroethylene)
TCM	Chloroform (= Trichloromethane)
P&T	Pump and Treat