

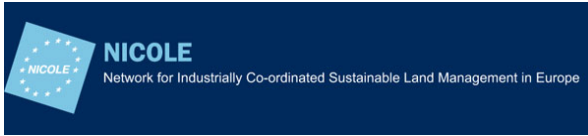

European Union Network for the Implementation  
and Enforcement of Environmental Law



Working Group  
Contamination

# Bodemplucht-Extractie -report

---

*Eindrapport*

***Datum van het verslag: 8 november 2021***

***Rapportnummer: 2020/09 SVE NL***

## Inleiding tot IMPEL

Het netwerk van de Europese Unie voor de tenuitvoerlegging en handhaving van de milieuwetgeving (IMPEL) is een internationale vereniging zonder winstoogmerk van de milieuinstanties van de EU-lidstaten, de toetredende landen en de kandidaat-lidstaten van de Europese Unie en de EER-landen. De vereniging is geregistreerd in België en heeft haar wettelijke zetel in Brussel, België.

IMPEL werd in 1992 opgericht als een informeel netwerk van Europese regelgevers en autoriteiten die zich bezighouden met de tenuitvoerlegging en handhaving van de milieuwetgeving. Doel van het netwerk is in de Europese Gemeenschap de nodige impulsen te geven om vooruitgang te boeken bij het waarborgen van een doeltreffender toepassing van de milieuwetgeving. De kern van de IMPEL-activiteiten betreft bewustmaking, capaciteitsopbouw en uitwisseling van informatie en ervaringen met betrekking tot tenuitvoerlegging, handhaving en internationale samenwerking op het gebied van handhaving, alsmede bevordering en ondersteuning van de uitvoerbaarheid en handhaafbaarheid van de Europese milieuwetgeving.

In de afgelopen jaren is IMPEL uitgegroeid tot een belangrijke, alom bekende organisatie, die wordt genoemd in een aantal wetgevings- en beleidsdocumenten van de EU, zoals het Milieuactieprogramma en de Aanbeveling betreffende minimumcriteria voor milieu-inspecties.

De deskundigheid en ervaring van de deelnemers binnen IMPEL maken het netwerk bij uitstek geschikt om te werken aan zowel technische als regelgevingsaspecten van de EU-milieuwetgeving.

Informatie over het IMPEL-netwerk is ook beschikbaar via de website van het netwerk: [www.impel.eu](http://www.impel.eu)

### Suggested citation:

Falconi M. et al. (2021), Bodemlucht-Extractie -report. IMPEL, COMMON FORUM, EIONET, NICOLE report no 2020/09 SVE NL, 302 pages. Brussels, ISBN 978-2-931225-14-1



<b>Titel van het verslag:</b> Bodemlucht-extractie rapport	<b>Nummer rapport:</b> 2020/09 SVE NL
<b>Verslag aangenomen op de algemene vergadering van IMPEL:</b> 7-8 december 2021, Ljubljana (Slovenië)	<b>Totaal aantal pagina's:</b> 302 <b>Verslag:</b> 50 pagina's <b>Bijlage:</b> 252 pagina's
<b>Project Managers:</b>	
Marco Falconi (IT)	IMPEL ISPRA
Dietmar Müller-Grabherr (AT)	Common Forum Umweltbundesamt AT
Frank Swartjes (NL)	EIONET WG Soil contamination RIVM
Tomas Albergaria (PT)	NICOLE Instituto Politécnico do Porto
<b>Auteurs:</b>	
Dietmar Müller-Grabherr (AT)	Common Forum Umweltbundesamt AT
Tomas Albergaria (PT)	NICOLE Instituto Politécnico do Porto
Francesca Benedetti (IT)	IMPEL MITE (Consultant)
Said El Fadili (BE)	IMPEL MILIEU BRUSSEL
Marco Falconi (IT)	IMPEL ISPRA
Federico Fuin (IT)	IMPEL ARPAV
Wouter Gevaerts (BE)	NICOLE ARCADIS
Gabriella Grima (MT)	IMPEL ERA
Dirk Krebs (DE)	IMPEL REGIERUNGSPRÄSIDIUM DARMSTADT
Christina Pisani (MT)	IMPEL ERA
Alex Plows (UK)	IMPEL CYFOETHNATURIOLCYMRU
Andrea Sconocchia (IT)	IMPEL ARPA UMBRIA
Frank Swartjes (NL)	EIONET WG Soil contamination RIVM
Asa Valley (SE)	EIONET WG Soil contamination NATURVÅRDSVERKET
<b>Bijdragers aan bijlage 1 ISCO:</b>	
Federico Caldera (IT)	MARES
Simone De Fazio (IT)	GOLDER ASSOCIATES
Boris Devic-Bassaget (FR)	SUEZ RR IWS REMEDIATION FRANCE
Paola Canepa (IT)	ARPA LOMBARDIA
Massimiliano Confalonieri (IT)	ARPA LOMBARDIA
Sophia Dore (US)	GHD
Alain Duchene (BE)	HAEMERS TECHNOLOGIES
Daniela Fiaccavento (IT)	ARPAV
René Fillion (US)	GHD
Jan Haemers (BE)	HAEMERS TECHNOLOGIES
Aline Jordens (BE)	HAEMERS TECHNOLOGIES
Angela Rosa Marin (IT)	ARPA LOMBARDIA
Valter Meda (IT)	ARPA LOMBARDIA
Davide Menozzi (AU)	GHD
Paola Panzeri (IT)	ARPA LOMBARDIA
Mathieu Petitjean (BE)	HAEMERS TECHNOLOGIES
Sara Puricelli (IT)	ARPA LOMBARDIA
Jean Rhone (FR)	HAEMERS TECHNOLOGIES
Diego Ricci (IT)	ARPA LOMBARDIA

Hatem Saadaoui (BE/TN)	HAEMERS TECHNOLOGIES
Luca Sacilotto (IT)	RAMBOLL
Valentina Sammartino (IT)	ARPA CAMPANIA
Hadas Sharon (IL)	LUDAN ENVIRONMENTAL TECHNOLOGIES
Ewa Szczebak (PL)	ARCADIS
Corrado Thea (IT)	GOLDER ASSOCIATES
Aldo Trezzi (IT)	RAMBOLL
Mathieu Vion (FR)	SUEZ RR IWS REMEDIATION FRANCE
<b>Reviewers:</b>	
Federico Caldera (IT)	MARES
Craig Cox (US)	COX COLVIN & ASSOCIATES
Mathieu Petitjean (BE)	HAEMERS TECHNOLOGIES
<b>Samenvatting</b>	
<p><i>Trefwoorden</i>  Bodemplucht Extractie, Duurzame sanering, Bodem, Grondwater, Bodembeleid, Sanering, Milieu, Geen netto ruimtebeslag, Verontreiniging, Verontreinigde locaties, Verontreiniging, Monitoring.</p> <p><i>Doelgroepen</i>  Bevoegde instanties voor goedkeuring/toepassing/monitoring van saneringstechnologieën, industriële exploitanten, milieubeschermingsinstanties, natuurbeschermingsinstanties, milieu-inspecties, instellingen voor milieumonitoring en onderzoek, technische universiteiten, milieuverenigingen, NGO's, verzekeringsmaatschappijen en -verenigingen, milieuconsultants.</p> <p>Als onderdeel van het werkprogramma voor 2020 heeft het IMPEL-netwerk het project "Water- en landsanering" (2020/09) opgezet, dat betrekking heeft op de criteria voor het evalueren van de toepasbaarheid van saneringstechnologieën.</p> <p>Het project "Sanering van water en bodem" heeft als uitgangspunt de definities en de belangrijkste stappen van de toepassing van saneringstechnologieën en richt zich op de technische procedures in verband met de saneringstechnologieën. Het uiteindelijke doel van het project is een document op te stellen met criteria voor de beoordeling van voorstellen voor de toepassing van saneringstechnologieën, om inzicht te krijgen in de toepasbaarheid, toepassing in het veld en bij de toepassing op ware schaal. Bijlage 1 bevat een aantal case studies die de lezer kunnen helpen te anticiperen op eventuele problemen die hij kan tegenkomen en na te gaan of de geboden oplossing op zijn locatie van toepassing is, in de wetenschap dat elke verontreinigde locatie verschilt van andere en er steeds een locatiespecifieke aanpak nodig is.</p> <p>De doelstelling van het project "Sanering van water en bodem" voor 2020-2021 was gericht op twee saneringstechnologieën, namelijk in situ chemische oxidatie en bodemplucht-extractie.</p> <p>Ten slotte wil het project "Water and Land Remediation" bijdragen aan de bevordering van de toepassing van in situ- en on-site-saneringstechnologieën voor bodem en grondwater, en minder toepassing van "Dig &amp; Dump" en "Pump &amp; Treat". Deze technieken worden in Europa op grote schaal toegepast, maar zijn op middellange termijn niet duurzaam. Bodem en water zijn natuurlijke hulpbronnen en moeten, wanneer dat technisch haalbaar is, worden teruggewonnen en niet verspild.</p>	
<b>Erkenningen</b>	
<p>Dit verslag is getoetst door een breder IMPEL-projectteam en door het IMPEL-team van deskundigen inzake water en land, het COMMON FORUM-netwerk, het NICOLE-netwerk, de EIONET-werkgroep Bodemverontreiniging en een groep externe beoordelaars.</p>	



# Disclaimer

---

Deze publicatie is tot stand gekomen in het kader van het IMPEL-project "Water & Land Remediation" met de steun van partnernetwerken die belangstelling hebben voor het beheer van verontreinigde grond. Dit document is geschreven en gereviewd door een team van auteurs en is bedoeld als primaire informatiebron voor het overbruggen en verbreden van kennis tussen Europese landen en regio's. Het streven naar een gemeenschappelijk inzicht in de mogelijkheden van de specifieke saneringstechnologie draagt bij aan een betere toepassing.

De hier gerapporteerde inhoud is gebaseerd op relevante bibliografie, de ervaring van de auteurs, en verzamelde case studies. Het document is mogelijk niet toegespitst op alle situaties waarin deze technologie is of zal worden toegepast. Case studies (zie bijlage) zijn erkende vrijwillige bijdragen. Het team van auteurs had niet de taak de verslagen van de case studies te evalueren of te verifiëren.

Ook kunnen sommige landen, regio's of lokale overheden bijzondere wetgeving, regels of richtsnoeren hebben uitgevaardigd om de technologische toepassingen in te kaderen.

Dit document is NIET bedoeld als richtsnoer of BBT-referentiedocument voor deze technologie. De bodemkundige, geologische en hydrogeologische omstandigheden van verontreinigde locaties in Europa vertonen een grote variabiliteit. Daarom is een op de locatie toegesneden ontwerp en uitvoering de sleutel tot succes bij de sanering van verontreinigde locaties. Elke aanbeveling kan dus worden toegepast, gedeeltelijk worden toegepast of niet worden toegepast. In elk geval kunnen de auteurs, de medewerkers en de betrokken netwerken niet verantwoordelijk worden gesteld.

De in dit document geuite meningen zijn niet noodzakelijk die van de individuele leden van de ondergetekende netwerken. IMPEL en zijn partnernetwerken raden individuen/organisaties die geïnteresseerd zijn in het toepassen van de technologie in de praktijk ten zeerste aan om een beroep te doen op ervaren milieudeskundigen.

Marco Falconi - IMPEL

Dietmar Müller Grabherr – COMMON FORUM inzake verontreinigde grond in Europa

Frank Swartjes – Europees Milieuagentschap (EEA)/ EIONET Werkgroep Soil Contamination

Tomas Albergaria - NICOLE

# Woordenlijst

TERM	DEFINITIE	BRON	PARAGRAAF
nalevingspunt	plaats (bijvoorbeeld in bodem of grondwater) waar de beoordelingscriteria moeten worden gemeten en niet mogen worden overschreden	ISO EN 11074	3.4.5
controle op naleving of prestaties	onderzoek of programma van voortdurende inspectie, testen of monitoring om te bevestigen dat een saneringsstrategie naar behoren is uitgevoerd (bijvoorbeeld dat alle verontreinigende stoffen zijn verwijderd) en/of, wanneer een prestatiebenadering is gekozen, dat deze blijft presteren op het gespecificeerde niveau	ISO EN 11074	6.1.5
verontreiniging <sup>1</sup>	stof(fen) of agentia die ten gevolge van menselijke activiteiten in de bodem aanwezig zijn	ISO EN 11074	3.4.6
verontreinigde site <sup>2</sup>	locatie waar verontreiniging aanwezig is	ISO EN 11074	2.3.5
besmetting	stof(fen) of agentia die ten gevolge van menselijke activiteiten in de bodem aanwezig zijn	ISO EN 11074	2.3.6
doeltreffendheid <sup>3</sup>	maat voor het vermogen van een saneringstechniek om een vereiste prestatie te bereiken	ISO EN 11074	6.1.6
emissie	het direct of indirect vrijkomen van stoffen, trillingen, warmte of geluid uit afzonderlijke of diffuse bronnen in lucht, water of op de bodem	IED	Art. 3 (4)
milieukwaliteitsnorm	het geheel van eisen waaraan een bepaald milieucompartiment op een bepaald moment moet voldoen	IED	Art. 3 (6)
Henry's coëfficiënt	verdelingscoëfficiënt tussen bodemlucht en bodemwater	ISO EN 11074	3.3.12
in-situ-behandelingsmethode <sup>4</sup>	behandelingsmethode die rechtstreeks wordt toegepast op het behandelde milieucompartiment (bv. bodem, grondwater) zonder dat de verontreinigde matrix aan de bodem wordt onttrokken	ISO EN 11074	6.2.3
uitloging	oplossen en verplaatsen van stoffen door water	ISO EN 11074	3.3.15

<sup>1</sup> In deze definitie wordt er niet van uitgegaan dat schade het gevolg is van de aanwezigheid van verontreiniging

<sup>2</sup> In deze definitie wordt er niet van uitgegaan dat schade het gevolg is van de aanwezigheid van besmetting].

<sup>3</sup> In het geval van een procesgebaseerde methode kan de doeltreffendheid worden uitgedrukt in de bereikte residuele concentraties van verontreinigende stoffen.

<sup>4</sup> Opmerking: ISO CD 241212 suggereert als synoniem: "in-situ (sanerings)techniek" [noot 1 bij tekst: Een dergelijke saneringsinstallatie wordt ter plaatse opgesteld en de behandeling van de verontreiniging is erop gericht om rechtstreeks op de ondergrond te worden toegepast] ISO CD 24212 3.1

vervuiler	in de bodem (of het grondwater) aanwezige stof(fen) of agentia die, vanwege zijn eigenschappen, hoeveelheid of concentratie, schadelijke effecten heeft (hebben) op de bodemfuncties	ISO EN 11074	3.4.18
vervuiling	de directe of indirecte inbreng door menselijke activiteiten van stoffen, trillingen, warmte of geluid in lucht, water of bodem, die de gezondheid van de mens of de milieukwaliteit kan aantasten, schade kan toebrengen aan materiële goederen, dan wel de belevingswaarde van het milieu of ander rechtmatig milieugebruik kan aantasten of in de weg kan staan	IED	Art. 3 (2)
saneringsdoelstelling	algemene term voor de doelstelling van de sanering, met inbegrip van technische (bv. restverontreinigingsconcentraties, technische prestaties), administratieve en wettelijke voorschriften	ISO EN 11074	6.1.19
saneringsstrategie <sup>5</sup>	combinatie van saneringstechnologieën en bijbehorende werkzaamheden waarmee aan specifieke verontreinigingsdoelstellingen (bv. restconcentraties van verontreinigende stoffen) en andere doelstellingen (bv. technische doelstellingen) kan worden voldaan en specifieke plaatselijke beperkingen kunnen worden overwonnen	ISO EN 11074	6.1.20
streefwaarde voor sanering	indicatie van de met de sanering te bereiken prestatie, meestal gedefinieerd als verontreinigingsgerelateerde doelstelling in termen van een restconcentratie	ISO EN 11074	6.1.21
verzadigde zone	zone van de bodem waar de poriënruimte volledig gevuld is met water op het ogenblik van de beschouwing	ISO EN 11074	3.2.6
bodem	de bovenste laag van de aardkorst, gelegen tussen het vast gesteente en het aardoppervlak. De bodem bestaat uit minerale delen, organisch materiaal, water, lucht en levende organismen	IED	Art. 3 (21)
bodemlucht	Het geheel aan gassen in de poriën van de bodem	ISO EN 11074	2.1.13
onverzadigde zone	zone van de grond waar de poriënruimte niet volledig gevuld is met vloeistof op het ogenblik van de beschouwing	ISO EN 11074	3.2.8

<sup>5</sup> De keuze van de methoden kan worden beperkt door een reeks locatiespecifieke factoren, gerelateerd aan topografie, geologie, hydrogeologie, neiging tot overstroming, en klimaat

# INHOUDSOPGAVE

---

<b>1</b>	<b>INLEIDING</b>	<b>10</b>
1.1	Achtergrond bodemlucht-extractie	10
1.2	Toepasbaarheid bodemlucht-extractie	11
1.3	Uitvoering bodemlucht-extractie	11
<b>2</b>	<b>BESCHRIJVING VAN DE TECHNIEK</b>	<b>12</b>
2.1	Algemene procesbeschrijving	12
2.2	Technisch systeem en onderdelen	12
2.3	Behandelbaarheid van verontreinigende stoffen	13
2.4	Rekening houdend met de geografie	13
2.5	Overwegingen voor het ontwerp van het systeem	14
<b>3</b>	<b>HAALBAARHEIDSTUDIE</b>	<b>17</b>
3.1	Terreinomstandigheden en het conceptuele terreinmodel	17
3.1.1	Aard en omvang van de verontreiniging	18
3.1.2	Geometrische kenmerken van de bron	19
3.1.3	Aanwezigheid van puur product	20
3.1.4	Resultaat van bodemluchtonderzoek	20
3.1.5	Luchtdoorlaatbaarheid	20
3.1.6	Heterogeniteiten en voorkeurspaden	21
3.1.7	Topografie	21
3.2	Gebruik van laboratoriumtesten bij het ontwerp van saneringsmaatregelen voor bodemlucht-extractie	21
3.3	Haalbaarheidsoverweging Bodemlucht-extractie	24
<b>4</b>	<b>IN VELD TEST</b>	<b>27</b>
4.1	Conventionele proeftest	29
4.1.1	Conventionele proeftest-apparatuur	31
4.1.2	Bodemlucht-extractie toenemende vacuümstap-test	32
4.1.3	Bodemlucht-extractie constante vacuümtest	35
4.2	Heliumdistributie en terugwinningstest	35
4.3	Bodemluchtbewaking	37
4.4	Minimumuitrusting voor Bodemlucht-extractie-veldtest	38
4.5	De extractieput	38
4.6	Voorstel voor een proefproject - minimumvereisten voor indiening	39
4.7	Alternatief voor proeftest	40

<b>5</b>	<b>PRESTATIEBEWAKING</b>	<b>42</b>
5.1	<b>Toezicht op de operationele fase</b>	<b>42</b>
5.1.1	<b>Chemische parameters</b>	<b>42</b>
5.1.2	<b>Fysieke parameters</b>	<b>43</b>
5.1.3	<b>Meteorologisch</b>	<b>43</b>
5.2	<b>Bevestiging van behalen saneringsdoelstelling en het afsluiten van het systeem</b>	<b>44</b>
5.2.1	<b>Mogelijke aanknopingspunten voor bevestiging van de opruiming</b>	<b>44</b>
5.2.2	<b>Voorgestelde procedure voor beëindiging van de bemonstering</b>	<b>46</b>
<b>6</b>	<b>CONCLUSIES</b>	<b>47</b>
6.1	<b>Doeltreffendheid, voordelen en nadelen</b>	<b>47</b>
6.2	<b>Operationele controle voor bodemlucht-extractie-toepassing</b>	<b>48</b>
	<b>REFERENTIES</b>	<b>49</b>

## 1 INLEIDING

IMPEL, het netwerk van de Europese Unie voor de tenuitvoerlegging en handhaving van de milieuwetgeving, ontwikkelt in het kader van het project Water en Bodem Sanering een reeks richtsnoeren die zijn toegespitst op de meest gangbare en meest gebruikte bodem- en grondwatersaneringstechnologieën. In deze richtsnoeren wordt de meest recente en geactualiseerde informatie over deze saneringstechnologieën samengevat, zodat de verschillende belanghebbenden, zoals eigenaars van terreinen, omwonenden, projectbeheerders, aannemers, regelgevers en andere beroepsbeoefenaars, een beter inzicht krijgen in de informatie die van een saneringsproject afkomstig is. Er wordt gebruik gemaakt van informatie die door de betrokken partijen wordt verstrekt en die afkomstig is uit door vakgenoten getoetste wetenschappelijke bronnen en officiële rapporten. De onderhavige richtlijn bundelt de meest recente kennis over één van de meest gebruikte saneringstechnologieën, bodemlucht-extractie.

### 1.1 Achtergrond bodemlucht-extractie

Bodemluchtextractie (verwante technologieën: bodemventilatie, in-situ bodemventilatie, bodemvacuum-extractie of vacuüm-extractie) is een van de meest gebruikte bodemsaneringstechnologieën [FRTR 2020]. Door het grootschalige gebruik ervan in de afgelopen decennia is Bodemlucht-extractie tegenwoordig een geaccepteerde, gevestigde en effectieve technologie voor de sanering van bodems die verontreinigd zijn met vluchtige (of locatiespecifiek ook semi-vluchtige) organische verbindingen in de onverzadigde zone van de bodem [Suthersan 1999].

In figuur 1.1 wordt een typisch schema van het Bodemlucht-extractie-proces gegeven. Bodemlucht-extractie maakt gebruik van de hoge vluchtigheid van de verontreinigende stoffen om ze te transporteren met behulp van een luchtstroom. Deze luchtstroom wordt in de bodem gecreëerd door de inductie van vacuümomstandigheden, die worden opgewekt door blowers/pompen. Deze lucht-/dampbeweging voert de verontreinigende stoffen naar extractieputten, waaruit ze worden overgebracht naar bovengrondse afgasbehandelingssystemen, waar ze naar behoren worden teruggewonnen of behandeld. De meest voorkomende behandelmecanismen zijn adsorptie aan actieve kool en vernietiging door katalytische of thermische oxidatie [EPA 2018, Soares 2012].

Bodemlucht-extractie is een veelzijdige saneringstechnologie en kan als separate saneringstechniek worden toegepast, waarbij de aandacht uitsluitend uitgaat naar de vervluchtiging en terugwinning van de verontreinigingen. Bodemlucht-extractie kan ook worden gecombineerd met andere saneringstechnologieën die andere mechanismen voor de verwijdering van verontreinigingen introduceren. Voorbeelden van andere saneringstechnologieën zijn biologische afbraak (bijvoorbeeld bodem- of "bio"-venting en lucht- of "bio"-sparging, wanneer toegepast op respectievelijk de onverzadigde en de verzadigde zone) of desorptie (thermisch verbeterde Bodemlucht-extractie, waarbij gebruik wordt gemaakt van verwarmingsprocessen zoals elektrische weerstand of hete lucht/stoominjectie om de vervluchtigingssnelheid van de verontreinigingen te verhogen en de extractie te vergemakkelijken). De lucht-/dampstroom die de Bodemlucht-extractie in de onverzadigde zone van de bodem creëert, bevordert de vervluchtiging van verontreinigingen, waardoor de mobiliteit ervan in de bodem toeneemt; en bevordert het transport van de vluchtige verontreinigingen naar de extractieputten [Suthersan 1999, EPA 2018]. Lagere lucht-/dampdebieten zoals gewoonlijk gebruikt bij bodemventilatie ondersteunen de biologische afbraak van afbreekbare verbindingen door de beluchting die in de bodemmatrix wordt bevorderd.

## 1.2 Toepasbaarheid bodemlucht-extractie

In verband met de eigenschappen van de locatie is Bodemlucht-extractie over het algemeen efficiënt voor doorlatende bodems met lage/matige organische stof- en vochtgehalten en met een diepte tot het grondwater tussen 2 en 30 m.

Wat het type verontreinigingen betreft, is gebleken dat Bodemlucht-extractie doeltreffend is voor gehalogeneerde en niet-gehalogeneerde vluchtige organische stoffen (VOS), beperkt doeltreffend voor gehalogeneerde en niet-gehalogeneerde half-vluchtige organische stoffen (SVOS), sommige opkomende verontreinigingen. Bodemlucht-extractie is niet toepasbaar voor 1,4-dioxaan of per- en polyfluoralkylstoffen (PFAS), brandstoffen, anorganische verontreinigingen, radionucliden en munitie [FRTR 2020, EPA 2018].

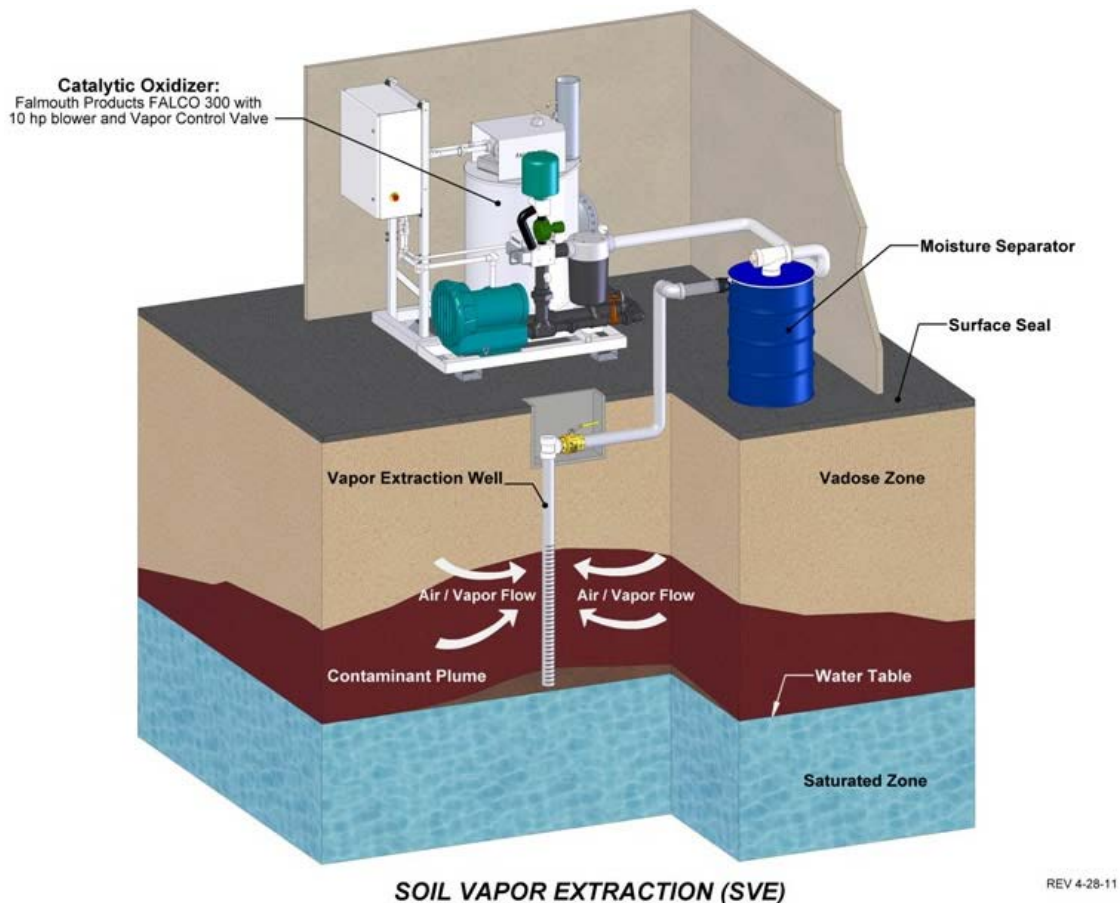

Figuur 1.1- Schema Bodemlucht-extractie.

## 1.3 Uitvoering bodemlucht-extractie

De implementatie van een Bodemlucht-extractie-systeem voor de sanering van een verontreinigde locatie vereist het gebruik van vacuümventilatoren/-pompen, de installatie van extractieputten (verticaal of horizontaal) en transportleidingen voor de extractie van de verontreiniging uit de bodem naar de oppervlakte voor verdere behandeling. De behandeling van de verontreinigde luchtstroom vereist het ontwerp/de bouw/vergunningen van faciliteiten en de passende apparatuur om de emissiebehandelingsdoelstellingen te bereiken, teneinde te voldoen aan de nationale/regionale regelgeving. Gezien de ervaringen met de exploitatie en het onderhoud van Bodemlucht-extractiesystemen bedraagt de doorlooptijd van een Bodemlucht-extractie in het algemeen tussen 1 en 3 jaar [FRTR 2020].

## 2 BESCHRIJVING VAN DE TECHNIEK

### 2.1 Algemene procesbeschrijving

Bodemlucht-extractie is een in-situ-technologie voor de sanering van verontreinigde bodems in de onverzadigde zone. Zij berust op de extractie van vluchtige verontreinigende stoffen door deze onverzadigde zone te "ontluchten" (of af te persen). Voorwaarde voor een succesvolle toepassing is voldoende doorlatendheid van de bodem.

Bodemlucht-extractie kan worden uitgevoerd met of zonder luchtinjectie. In het geval dat er geen actieve luchtinjectie plaatsvindt, dringt verse lucht vanuit de atmosfeer via het bodemoppervlak de bodem binnen. De luchtcirculatie wijzigt het chemisch evenwicht tussen de verschillende fasen (gas, poriewater, bodemdeeltjes), waardoor de vervluchtiging van vluchtige verontreinigende stoffen uit vaste en/of vloeibare fasen wordt bevorderd. De geëxtraheerde dampen worden onderworpen aan een off-gas behandeling.

Het gehele proces moet worden gecontroleerd en beheerd door een samenhangend bewakingsstelsel (gericht op bv. Het luchtdebiet, de concentratie verontreinigende stoffen, de temperatuur, de vochtigheid)

### 2.2 Technisch systeem en onderdelen

Het ventilatiesysteem, dat ter plaatse moet worden geplaatst, bestaat uit de volgende hoofdprocesapparatuur:

- verticale (of horizontale) extractieputten (zogenaamde "extraction drains") om toegang te krijgen tot de verontreinigde bodemlaag;
- verticale (of horizontale) injectieputten (of -punten) om de luchtstroom in het te saneren gebied te versterken/controleren, met name op de grenzen van het gebied, met kleppen (en debietmeters) om alle onderdelen van het systeem met elkaar te verbinden;
- een condensaatafscheider of demister om het reinigingssysteem te beschermen tegen vocht en grondwater dat door de geleide luchtstroom wordt gemobiliseerd;
- een aanjager/vacuüminstallatie (om de negatieve druk op te wekken die nodig is om bodemlucht naar extractieputten te doen stromen);
- een systeem voor de behandeling van afgevoerde bodemlucht (om de verontreinigende stoffen uit de afgevoerde bodemlucht te verwijderen).

De meest gebruikelijke behandelmecanismen zijn adsorptie aan actieve kool en vernietiging door katalytische of thermische oxidatie. Een typisch schema van een Bodemlucht-extractie-systeem en de onderdelen ervan is weergegeven in figuur 2.1. Aangezien ontvlambare stoffen (bv. benzine) relevante verontreinigende stoffen zijn, is het van cruciaal belang een gezondheids- en veiligheidsplan op te stellen en rekening te houden met beperkingen ten aanzien van technologieën voor de behandeling van afgevoerde bodemlucht.



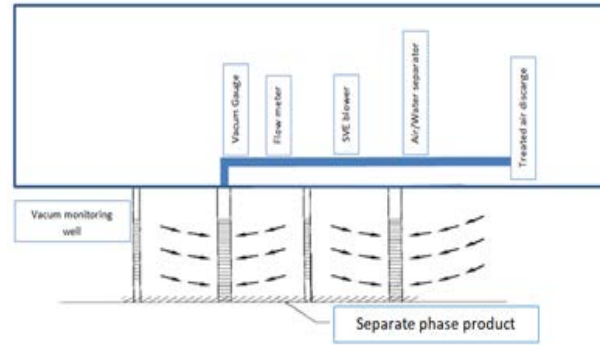

Figuur 2.1- Onderdelen van een Bodemlucht-extractie-installatie

## 2.3 Behandelbaarheid van verontreinigende stoffen

De doeltreffendheid van Bodemlucht-extractie is over het algemeen bewezen voor vluchtige organische stoffen (VOS). Locatiespecifiek en/of in combinatie met andere technologieën kunnen ook toepassingen voor semi-vluchtige organische stoffen (SVOC's) succesvol zijn. In het algemeen is vereist dat verontreinigende stoffen niet sterk aan de vaste fase van de bodem worden geadsorbeerd.

Typische toepassingen zijn gericht op aromaten (BTEX), fenolen, benzine, HC <12, gechloreerde oplosmiddelen (chloroform, VC, DCM, DCA, DCE, TCA, TCE, TC, PCE) en chloorbenzenen (met lage substitutie). Daarom wordt bodemlucht-extractie vaak toegepast op petrochemische verontreinigde locaties, benzinestations, werkplaatsen/industrieën voor metaalbewerking en metaalverwerking (ontvetten en chemisch reinigen).

Bepalende factoren bij de toepassing van Bodemlucht-extractie zijn de eigenschappen van de verontreinigingen, met name de verdeling over de fasen van de bodem. Ook de bodemkundige karakterisering van de locatie is van belang, met name de stratigrafie en eigenschappen van de bodem, zoals permeabiliteit, porositeit en heterogeniteit.

Bepaalde kenmerken van de verontreiniging zijn zeer belangrijk voor de efficiëntie en doeltreffendheid van het proces. De dampspanning van een verbinding is de partiële druk van die verbinding in evenwicht met zijn vloeistof (puur product). Het is dus een maat voor het vluchtig-vloeibaar-evenwicht. Bodemlucht-extractie is geschikt voor stoffen met een dampspanning > 0,5-1,0 mmHg. Het kookpunt is gerelateerd aan de dampspanning en bepaalt de mate van toepasbaarheid. Bodemlucht-extractie is geschikt voor stoffen met een kookpunt lager dan 250-300° C. Henry's constante geeft de verhouding weer tussen de concentratie van een bepaalde stof in de gasfase en van dezelfde stof in de waterfase. Bodemlucht-extractie is geschikt voor stoffen met een Henry's constante > 0,001 atm m<sup>3</sup> / mol.

## 2.4 Rekening houdend met de geografie

De stratigrafie van de bodemlagen en de eigenschappen van de bodemlagen zijn van groot belang voor de effectiviteit en efficiëntie van de toepassing van Bodemlucht-extractie. Daarom is het van cruciaal belang inzicht te hebben in de ondergrond van de locatie om een consistent conceptueel locatiemodel te ontwikkelen (zie hoofdstuk 3.1).

De belangrijkste bodemeigenschappen zijn porositeit, permeabiliteit, (poriën)watergehalte en heterogeniteit. De luchtstroming in bodemlagen verloopt via de poriën in de bodem, zodat een grotere porositeit de luchtstroming in de bodem bevordert. De aanwezigheid van water in de poriën vormt een fysiek obstakel dat de luchtstroming belemmert. Anderzijds is een zeer laag vochtgehalte bepalend voor een sterkere adsorptie van bepaalde verontreinigende stoffen aan de bodem.

De aanwezigheid van gebieden die worden gekenmerkt door een sterk verschillende textuur en permeabiliteit kan de luchtstroming beheersen en zo het project beïnvloeden en kortsluiting veroorzaken (bijvoorbeeld preferentiële luchtstroming in gebieden met inhomogeniteit of in de nabijheid van de zuigschacht). Een andere belangrijke factor die de luchtstroming kan beperken, is het niveau van de grondwaterspiegel. De bij de onttrekkingsputten geïnduceerde depressie kan een stijging van het piëzometrisch niveau veroorzaken (een depressie van 0,2 atm zou een stijging van ongeveer 2 m veroorzaken) en de putten en het Bodemlucht-extractie-systeem gedeeltelijk onder water zetten. Gunstige omstandigheden kunnen worden verondersteld bij een diepte van de grondwaterspiegel van ongeveer minimaal 3 m; dieptes van minder dan 1,5 m zijn niet aan te bevelen.

Ook hogere gehalten aan organische koolstof in de bodem (bijv. in het geval van veengrond) kunnen een belemmering vormen voor Bodemlucht-extractie. Bij toenemende gehalten aan organische stof nemen desorptie en vervluchtiging eveneens af; mogelijk neemt dan ook de doorlatendheid aanzienlijk af).

De hieronder opgesomde parameters kunnen de sleutel zijn tot een succesvolle toepassing van bodemlucht-extractie:

- hoge permeabiliteit van de ondergrond;
- homogene bodemsamenstelling, d.w.z. afwezigheid van lagen en lenzen met een verschillende textuur, afwezigheid van preferentiële luchtstromingstrajecten als gevolg van de aanwezigheid van ondergrondse infrastructuur;
- afwezigheid van lenzen of veenlagen met een groot absorptievermogen voor organische verontreinigingen;
- geen ingesloten verontreinigingspoelen;
- geen ondoordringbare of weinig doorlatende lagen;
- geen ondiep grondwater.

## 2.5 Overwegingen voor het ontwerp van het systeem

Het ontwerp van de Bodemlucht-extractie bestaat uit de definitie van:

a) Werkingsparameters van het systeem:

- luchtafvoersnelheid;
- mate van onderdruk in de extractieput
- invloedsstraal.

b) Definitie van systeemcomponenten:

- aantal winningsputten en hun positie;
- bouw van de putten;
- afzuigventilator;
- water-luchtafscheider;
- instrumentatie bodemlucht-behandelingsunit (met warmtewisselaar).

Voor het ontwerp van de bodemlucht-extractie worden in het veld proeftesten uitgevoerd. Deze testen moeten ten minste 1 extractieput omvatten en ten minste 3 meetpunten (eventueel meerdere niveaus in geval van heterogeniteit van de bodem) waarin het bereikte vacuüm wordt gemeten. Voor een nuttige proeftest moet in de eerste plaats het extractiedebiet worden geregeld met de regelklep die normaal op het inlaatkanaal is aangebracht. Voor elke stand van de klep (die overeenkomt met een bepaald extractiedebiet) moet ongeveer 30 minuten worden gewacht tot het systeem is gestabiliseerd en moeten de volgende metingen worden verricht:

- mate van onderdruk bij de extractieput;
- mate van onderdruk geïnduceerd op de controlepunten;
- debiet van de afgezogen bodemlucht;
- samenstelling en temperatuur van het afgezogen gas.

De metingen worden herhaald voor verschillende graden van klepopening. De intrinsieke permeabiliteit van de bodem ( $k$ ) kan worden geschat aan de hand van de metingen die tijdens de proef worden uitgevoerd.

Een van de belangrijkste ontwerpcriteria is de invloedsstraal, die gebaseerd is op de tijdens de proeftest verzamelde metingen. Bij gebrek aan een gegevens uit reeds beëindigde gevallen, is dit de meest betrouwbare methode voor het ontwerpen van een sanering in de praktijk.

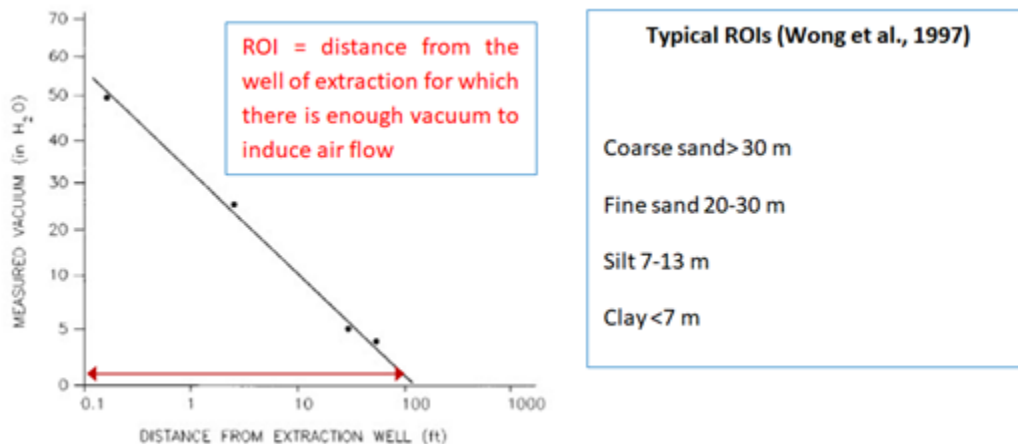

Figuur 2.4- Invloedsstraal (ROI)

Zodra de invloedsstraal is bepaald, wordt een reeks cirkels getrokken met een straal gelijk aan die van de invloedsstraal, waarbij wordt gezorgd voor een gedeeltelijke overlapping, ten einde te voorkomen dat er gebieden niet worden behandeld.

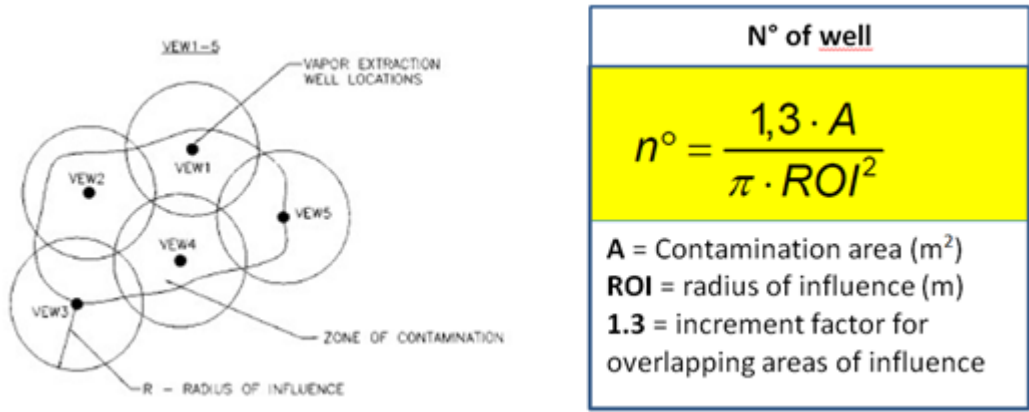

Figuur 2.5 – Schematisatie van de aangelegde extractie-putten ten opzichte van de verontreiniging

Zodra de diepte van de raampartij is bepaald (over het algemeen gelijk aan de diepte van de verontreiniging) en de invloedstraal van het vacuüm bekend is, kunnen de luchtextractiesnelheden (extractiesnelheden) worden vastgesteld.

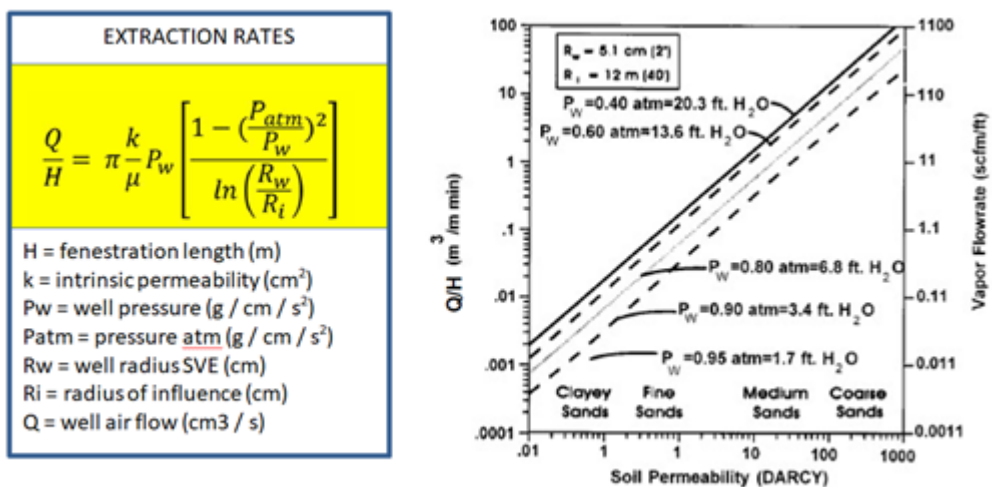

Figuur 2.6 Extractiepercentages

Typische ontwerpwaarden voor de extractiesnelheid uit proeftesten en toepassingen zijn 20-200 m<sup>3</sup>/uur; typische ontwerpwaarden voor de putdepressie uit proeftesten en toepassingen zijn 0,5-1 atm.

De geëxtraheerde bodemlucht wordt op verschillende manieren behandeld, afhankelijk van de concentraties. Voor brandbare stoffen is de belangrijkste parameter de onderste explosiegrens (LEL). Actieve kool en katalytische oxidatie zijn van toepassing als C(damp) <25% LEL; thermische oxidatie wordt aanbevolen als C(damp) <25-50% LEL; biofilter is van toepassing als C(damp) <10% LEL.

### 3 HAALBAARHEIDSTUDIE

De voornaamste criteria voor de selectie van deze technologie zijn de luchtdoorlatendheid van de ondergrond en de vluchtigheid van de verontreinigende stoffen. De technologie moet vervolgens verder worden gescreend met inachtneming van een aantal locatiespecifieke factoren.

#### 3.1 Terreinomstandigheden en het conceptuele terreinmodel

Talrijke fysische en chemische omstandigheden van de locatie hebben een aanzienlijke invloed op de effectiviteit van bodemlucht-extractie als saneringsalternatief. Deze parameters, die moeten worden bepaald in het veld, worden in de onderstaande paragrafen besproken, samen met de gegevens over de locatie-karakterisering die relevant zijn voor de haalbaarheid en het ontwerp van bodemlucht-extractie.

Figuur 3.1 geeft een overzicht van deze gegevens gerelateerd aan de karakterisering van de locatie. Het belang van het zo vroeg mogelijk verzamelen van de relevante gegevens kan niet genoeg worden benadrukt. Hoewel het inzicht in de verontreinigde locatie nooit perfect zal zijn (omdat de karakteriserings-instrumenten, financiële middelen en bemonsteringsmethoden praktische beperkingen hebben), is men verplicht bewijsmateriaal te verzamelen en te documenteren dat convergeert naar een consistent beeld van de verontreinigde locatie. Dit beeld, of conceptueel model, van de verontreinigde locatie is noodzakelijkerwijs veelzijdig en multidisciplinair, in die zin dat het een verscheidenheid van soorten gegevens omvat. Het is ook dynamisch, in die zin dat het evolueert naarmate nieuwe gegevens beschikbaar worden. Het is belangrijk het conceptuele model van de verontreinigde locatie voortdurend te herformuleren naarmate nieuwe informatie uit het veld beschikbaar komt.

Het conceptuele model van de locatie moet uitgaan van een (hydro)geologische locatiebeschrijving en moet de primaire bron(nen) van de verontreiniging, de vrijgekomen massa, het vrijkomingspatroon en met name de verticale en horizontale omvang van de verspreiding van verontreinigende stoffen in de bodemlucht-zone karakteriseren. Er zijn een aantal essentiële aspecten van de karakterisering van de bodemlucht -zone voor bodemluchtextractie. Deze omvatten in het kort

- type/toestand van de oppervlaktebedekking (bijvoorbeeld asfalt, vegetatie);
- aanwezigheid en omvang van ondergrondse structuren of nutsvoorzieningen;
- topografie;
- verdeling en diepte van het bodemtype;
- diepte tot de grondwaterspiegel en de seizoenschommelingen ervan;
- vochtgehalte van de bodem en de variabiliteit ervan;
- dikte van de capillaire zone;
- luchtdoorlatendheid en hoe deze varieert binnen het betrokken gebied;
- organische koolstofgehalte en variabiliteit ervan.

Elk (of een combinatie) van deze belangrijke locatie-elementen kan de doeltreffendheid van bodemlucht-extractie sterk beïnvloeden en/of een ernstige beperking vormen voor bodemlucht-extractie. Vaak worden gegevens over de locatie-karakterisering die potentieel belangrijk zijn voor de toepassing van bodemlucht-extractie-technologieën niet verzameld, omdat degenen die verantwoordelijk zijn voor het nemen van grondboringen en observatieputten deze niet kennen of niet de opdracht hebben gekregen ze te identificeren en systematisch te registreren.

Inzicht in de aard van de bovenste bodem-horizonten is van cruciaal belang. Aanwijzingen voor kenmerken van de ondergrond, zoals zand- of kiezelhoudende lenzen in een matrix met een fijnere structuur, of macroporiën, die kunnen dienen als preferentiële luchtstromingsbanen, moeten worden geregistreerd. Bodemkleuren en -

vlekken kunnen een indicatie geven van de zone waarbinnen de grondwaterspiegel seizoensgebonden fluctueert. Op stedelijke of industriële locaties moet, indien mogelijk, het contact tussen verstoorde grond/opgevlude grond en inheemse grond worden vastgesteld. Standaardmethoden voor bodemkarakterisering moeten voor deze doeleinden worden gebruikt door personen die in het gebruik daarvan zijn opgeleid (Breckenridge, Williams, and Keck 1991; USEPA 1991h).

Parameter	Collection Method	Analytical Method
Air-phase permeability (field-scale)	Pneumatic pump test	See Cho and DiGiulio (1992)
Air-phase permeability (core-scale)	In situ or undisturbed 50- to 75-mm diameter soil sample typical	See paragraph 4-2d and Appendix D; Corey (1986a)
Stratigraphy/heterogeneity	Soil boring and/or test pit	Visual observation; Breckenridge, Williams, and Keck (1991); USEPA (1991h)
Grain size	Split spoon or other soil sample	ASTM D422-63 (1998)
Porosity	Undisturbed 50- to 75-mm-diameter soil sample	Calculated from dry bulk density and particle density
Dry bulk density	Undisturbed 50- to 75-mm-diameter soil sample	ASTM D2850
Organic carbon content	Split spoon sample	SW-846 9060; Churcher and Dickhout (1989)
Moisture content (saturation)	Neutron logging via access tubes Tensiometers Undisturbed 50- to 75-mm diameter soil sample	Neutron gauge (Gardner 1986), ASTM D3017, ASTM D5220 Cassel and Klute (1986) ASTM D2216-92
Soil moisture retention (Capillary pressure saturation curve)	Undisturbed 50- to 75-mm diameter soil sample	Klute (1986); ASTM D2325-93
Dry end soil moisture retention	Undisturbed 50- to 75-mm diameter soil sample	Psychrometer Method (Jones, Gee, and Heller 1980)
Soil Temperature	Thermometer, Thermocouple	Portable Meter
Depth to groundwater and seasonal variations	Water table monitoring wells, Water level meter or interface gauge and surveyed well elevations	ASTM D4750
Volatile hydrocarbon content in soil gas	In situ	Downey and Hall (1994); ASTM D3416-78
O <sub>2</sub> content in soil gas	In situ	Portable meter, electrochemical cell method
CO <sub>2</sub> content in soil gas	In situ	Portable meter, infrared adsorption method
Microbial respiration rate	In situ	Hinchee et al. 1992

Figuur 3.1- Samenvatting van de test- en analysemethode

### 3.1.1 Aard en omvang van de verontreiniging

Bij de karakterisering van het terrein moeten de chemische eigenschappen van de ondergrond en de aard en omvang van de verontreiniging worden bepaald om de haalbaarheid van bodemlucht-extractie te kunnen beoordelen. Verontreinigingen die het meest geschikt zijn voor bodemlucht-extractie zijn VOC-houdende vloeistoffen en VOC's, waaronder benzine, kerosine, veel dieselbrandstofbestanddelen, freonen en oplosmiddelen zoals PCE, trichlooretheen en methyleenchloride.

In onderstaande figuur worden verschillende groepen verontreinigende stoffen gepresenteerd en wordt hun ontvankelijkheid voor bodemlucht-extractie geschat.

Contaminant Groups		Example of Contaminants	Effectiveness
<b>Organics</b>	Halogenated VOCs	Tetrachloroethene, Trichloroethene	a
	Halogenated SVOCs*	Para-dichlorobenzene	b
	Nonhalogenated VOCs	Gasoline	a
	Nonhalogenated SVOCs*	Diesel fuel	a
	PCBs	Aroclor - 1242	c
	Pesticides	Chlordane	c
	Dioxins/furans	2,3,7,8-Tetrachlorodibenzo-p-dioxin	c
	Organic cyanides		c
	Organic corrosives		c
	Explosives	2,4,6 Trinitrotoluene	c
<b>Inorganics</b>	Volatile metals	Mercury, tetraethyl lead	c
	Nonvolatile metals	Nickel, chromium	c
	Asbestos		c
	Radioactive materials		c
	Inorganic corrosives		c
	Inorganic cyanides	Sodium cyanide	c
<b>Reactive</b>	Oxidizers		c
	Reducers		b

Figuur 3.2- Toepasbaarheid van bodemlucht-extractie op groepen verontreinigende stoffen (a = goed toepasbaar; b = gemiddeld goed toepasbaar; c = niet goed toepasbaar)

### 3.1.2 Geometrische kenmerken van de bron

- De omvang van de verontreiniging moet in drie dimensies worden bepaald tijdens de fase van de locatiekarakterisering van het project, teneinde geschikte technologieën te kunnen screenen. Met betrekking tot bodemlucht-extractie moeten zowel de onverzadigde zone als de verzadigde zone worden gekarakteriseerd.
- De diepte van de verontreiniging is van invloed op de haalbaarheid en het ontwerp van bodemlucht-extractie-systemen. Indien de verontreiniging beperkt is tot het grondoppervlak, zullen andere technieken dan bodemlucht-extractie de voorkeur genieten. Indien de verontreiniging zich in de verzadigde zone bevindt, zal bodemlucht-extractie alleen niet geschikt zijn. Op locaties waar bodemlucht-extractie geschikt is, zal de diepte van de verontreiniging van invloed zijn op het puttype (horizontaal versus verticaal), de afstand tussen de putten en andere ontwerpfactoren.
- De omvang van de verontreinigde grond is van invloed op de geschiktheid van bodemlucht-extractie. Als het volume klein is, kunnen andere alternatieven, zoals afgraven en elders opslaan,



kosteneffectiever zijn. Het volume verontreinigde grond is ook van invloed op veel aspecten van het systeemontwerp, zoals het aantal putten, de grootte van de blowers en de capaciteit van het afgasbehandelingssysteem.

- Bij het bepalen van de geschiktheid en het ontwerp van bodemlucht-extractie-systemen moet rekening worden gehouden met potentiële externe bronnen van verontreinigende stoffen in de dampfase. Indien tijdens de bodemlucht-extractie een significante verontreiniging van buitenaf door de dampfase naar de ondergrond kan migreren, moet het systeemontwerp voorzien in luchtinjectieputten of andere middelen om dit te voorkomen.

### 3.1.3 Aanwezigheid van puur product

De locatie-onderzoeker moet bepalen of er puur product aanwezig is (drijf- of zaklagen).. Puur product concurreert met bodemlucht en -vocht om poriënruimte in de onverzadigde zone, waardoor de permeabiliteit van de bodemluchtfase afneemt. Bovendien vormt Puur product een voortdurende bron van verontreinigende stoffen. Er zijn restverzadigingen in de onverzadigde zone gerapporteerd van tussen de 15 en 50 procent van de beschikbare poriënruimte (USEPA 1989c).

Indien de aanwezigheid van puur product wordt vermoed, kan de toepassing van bodemlucht-extractie het risico van migratie van puur product naar dieper gelegen hydrologische lagen bevorderen. Dit kan bijvoorbeeld het geval zijn als er zich een zaklaag bevindt in gebroken gesteente boven de grondwaterspiegel. Er is een theorie dat het induceren van luchtstroming naar een winningsput in een dergelijke omgeving gepaard kan gaan met een tegenstroming van een zaklaag dieper in het breuksysteem, en misschien in de verzadigde zone. In een dergelijke situatie zou een ontheffing wegens technische onuitvoerbaarheid van toepassing kunnen zijn (USEPA 1993g).

### 3.1.4 Resultaat van bodemluchtonderzoek

Door hun aard komen verontreinigingen die geschikt zijn voor bodemlucht-extractie in aanmerking voor de uitvoering van bodemluchtonderzoek. Vaak zijn bodemluchtmetingen in het veld een nuttige manier om de aard en de omvang van de bodemverontreiniging op een locatie te karakteriseren. Vaak zijn veldmetingen van bodemlucht-concentraties van verontreinigende stoffen, bevestigd door een beperkt aantal laboratoriumanalyses, voldoende voor de karakterisering van de locatie. Een goede kwantitatieve correlatie tussen bodemlucht- en bodemconcentraties kan echter zelden worden verkregen. Dit is met name het geval wanneer hogere concentraties verontreinigende stoffen aanwezig zijn ten gevolge van achtergebleven puur product. Bij het vergelijken van bodemlucht- en bodemmonsterconcentraties is het nuttig te realiseren dat de concentratie in bodemmonsters verontreinigingen in alle bodemcompartimenten weergeven, terwijl de concentratie in bodemlucht alleen de verontreinigingen in dampvorm weergeeft. Bodemlucht-onderzoeken kunnen ook een indicatie geven van de verontreinigings-concentraties die in eerste instantie in bodemlucht-extractie-offgas kunnen worden verwacht.

### 3.1.5 Luchtdoorlaatbaarheid

Luchtdoorlatendheid, het vermogen van de bodem om lucht door te laten, is een van de meest kritische parameters die van invloed zijn op de geschiktheid en het ontwerp van een bodemlucht-extractie. Luchtdoorlatendheid is een functie van de eigenschappen van de vaste bodemdeeltes en het vochtgehalte. Luchtdoorlatendheid heeft een grote invloed op de luchtstroomsnelheid en de terugwinning van verontreinigende stoffen. Grofkorrelige bodems vertonen doorgaans grote waarden voor luchtdoorlatendheid en meer uniforme luchtstromingspatronen. Bodems met een luchtdoorlatendheid van minder dan ongeveer  $10^{-10}$  cm<sup>2</sup> zijn wellicht niet geschikt voor bodemlucht-extractie (USEPA 1993d).



### 3.1.6 Heterogeniteiten en voorkeurspaden

Heterogeniteiten spelen een belangrijke rol in de verspreiding van verontreinigingen in de onverzadigde zone en worden veroorzaakt door ruimtelijke variaties in bodemtypen, gelaagdheid, porositeit en vochtgehalte. Tijdens de werking van een bodemlucht-extractie-systeem kunnen deze variaties de luchtstromingspatronen en uiteindelijk de terugwinning van verontreinigende stoffen in de onverzadigde zone beïnvloeden. Als de onverzadigde zone bijvoorbeeld bestaat uit afwisselend grofkorrelige en fijnkorrelige grondlagen, kan de luchtstroming worden beperkt tot de grofkorrelige lagen. Verontreinigingen worden vaak veel langzamer uit de fijnkorreliger lagen verwijderd. Bodemboringen, kegelpenetrometrie en bodemprofielonderzoek van de blootgelegde materialen uit proefputten behoren tot de methoden om informatie over fysische heterogeniteiten te verkrijgen.

In sommige gevallen kunnen ondergrondse nutsvoorzieningen, zoals regen- en rioolbuizen, of het opvulmateriaal van deze voorzieningen, kortsluiting veroorzaken in de luchtstroom van een bodemlucht-extractie-systeem. Het gevolg kan zijn dat de luchtstroom zich concentreert langs deze elementen in plaats van binnen de bodemzone die moet worden behandeld. Bovendien kunnen deze elementen migratieroutes vormen voor zowel vloeistoffen in vrije fase als bodemlucht binnen de onverzadigde zone. De oriëntatie en geometrie van deze elementen kunnen dus bepalend zijn voor de richting waarin de vloeistoffen of dampen migreren. Vaak bestaan er geen nauwkeurige bouwtekeningen van ondergrondse nutsvoorzieningen, zodat personen die met de locatie vertrouwd zijn, moeten worden geraadpleegd. Kelderverdiepingen van nabijgelegen gebouwen en andere kenmerken die de stroming kunnen beïnvloeden moeten worden gerapporteerd.

### 3.1.7 Topografie

De topografie en de aard van het grondoppervlak zijn van invloed op bodemlucht-extractie. Een ondoorlatend oppervlak zal de horizontale luchtstroming versterken en de invloedstraal vergroten. Een doorlatend oppervlak zal het tegenovergestelde doen en zal de hoeveelheid atmosferische lucht die de ondergrond binnendringt vergroten. Voorzieningen aan het oppervlak, zoals gebouwen, wegen en nutsvoorzieningen, kunnen van bodemlucht-extractie een aantrekkelijk alternatief maken in vergelijking met andere opties. Indien er verharding aan het bodemoppervlak aanwezig is, moet de integriteit ervan worden onderzocht. Scheuren moeten worden opgemerkt en, indien mogelijk, gedicht.

## 3.2 Gebruik van laboratoriumtesten bij het ontwerp van saneringsmaatregelen voor bodemlucht-extractie

Kolomproeven ter bepaling van ontwerpparameters. Ball en Wolf (1990) bevelen kolomproeven in het laboratorium aan voor het bepalen van ontwerpparameters voor bodemlucht-extractie-systemen die gericht zijn op enkelvoudige verontreinigingen in homogene isotrope bodems op kleine locaties. Hun aanpak bestaat uit het verpakken van een kolom met het bodemmateriaal van de locatie, het toepassen van een representatieve luchtstroom, en het meten van effluentconcentraties van verontreinigingen als functie van het aantal poriënvolume-uitwisselingen. Vervolgens wordt een exponentiële afbraakvergelijking op deze gegevens gefit; de kalibratieparameter hieruit wordt gebruikt in een opgeschaalde voorspelling van de emissiesnelheid voor de veldtoepassing van het bodemlucht-extractie-systeem. Met deze informatie kunnen de totale bodemsaneringstijd en -kosten worden geschat.

Kolomproeven om de effectiviteit van bodemlucht-extractie te bepalen. Wanneer er twijfel bestaat over de vraag of bodemlucht-extractie op een locatie effectief zal zijn, beveelt de USEPA (1991c) kolomproeven aan voor de evaluatie van de saneringstechniek. Deze stap kan worden overgeslagen wanneer de dampspanning

van de verontreinigde stoffen 10 mm Hg of hoger is. Kolomproeven zijn ook niet haalbaar voor locaties met gebroken vast gesteente of heterogene materialen bestaande uit grote stukken puin.

Deze studies zijn betrekkelijk goedkoop en impliceren dat ongeveer 2000 poriën aan luchtvolume door de kolom wordt geleid (gedurende ongeveer 6 dagen). Er zij op gewezen dat deze equivalentie afhankelijk is van de bodemgesteldheid, zoals doorlatendheid en vochtgehalte. In een droge, zandige bodem zouden de 2000 poriën bijvoorbeeld in slechts één jaar kunnen worden uitgewisseld, terwijl dit in een vochtige, slibachtige klei meer dan 6 jaar zou kunnen vergen. In de meeste gevallen zullen de specifieke doorstromingsscenario's voor de locatie echter ergens in het bereik van 3 tot 6 jaar liggen. De reden om kolomproeven uit te voeren is het bestuderen van de verspreidingskinetiek van de bodem. Gebleken is dat het vrijkomen van verontreinigende stoffen bijna altijd binnen de eerste 1000 poriënvolume-uitwisseling beperkt wordt door diffusie, hetgeen erop wijst dat betrekkelijk snel een evenwicht wordt bereikt. Een studieperiode van 2000 poriënvolumes-uitwisseling maakt het derhalve mogelijk de diffusiekinetiek te kwantificeren.

Tijdens de test worden de concentraties verontreinigende stoffen in de bodemlucht gecontroleerd en een reductie van 80 procent of meer wijst erop dat bodemlucht-extractie potentieel geschikt is voor de locatie en verder moet worden geëvalueerd met aanvullend kolomonderzoek. Als een reductie van meer dan 95% wordt bereikt, kan de residuele bodem uit de kolom worden geanalyseerd om de resterende verontreiniging te kwantificeren. Als de concentraties lager zijn dan de saneringsdoelstellingen, kunnen kolomproeven voor de keuze van de sanering worden overgeslagen en kunnen luchtdoorlaatbaarheids-testen worden uitgevoerd.

Voor de meeste bodemlucht-extractie-toepassingen zijn kolomtesten niet vereist, maar kunnen onder bepaalde omstandigheden nuttig zijn. Dat is bijvoorbeeld het geval bij ontluchting en/of biologische afbraak van recalcitrante (moeilijk afbreekbare) verontreinigingen. Voor kolomproeven wordt meestal 2 tot 8 kg verontreinigde grond gebruikt (bijvoorbeeld met kolomafmetingen van 5 tot 10 cm diameter en 30 tot 60 cm lengte) en deze worden uitgevoerd tot de resultaten een asymptotisch verloop vertonen, waarbij de duur en de kosten afhankelijk zijn van de bodemkenmerken en de verontreinigende stoffen. Voorafgaand aan de kolomproeven kunnen metingen worden verricht, zoals de bepaling van de bulkdichtheid, vochtgehalte en analyse van de concentraties verontreinigende stoffen in de bodemmatrix, in het percolatiewater en in de bodemlucht. Verschillende luchtstroomsnelheden kunnen worden getest om de gevoeligheid van de verwijderingspercentages van verontreinigende stoffen voor de luchtstroomsnelheid te evalueren. Metingen tijdens de test omvatten de druk van de in- en uitstromende lucht, de concentraties van de verontreinigende stoffen in de uitstromende lucht, de snelheid van de luchtstroom en de temperatuur. Na de test worden de concentraties van verontreinigende stoffen in de bodemmatrix en in het TCLP (*Toxicity characteristic leaching procedure*)-percolatiewater gemeten om ze te kunnen vergelijken met de saneringsdoelstellingen. Een schets van een kolomtestopstelling is te zien in Figuur 3.3.

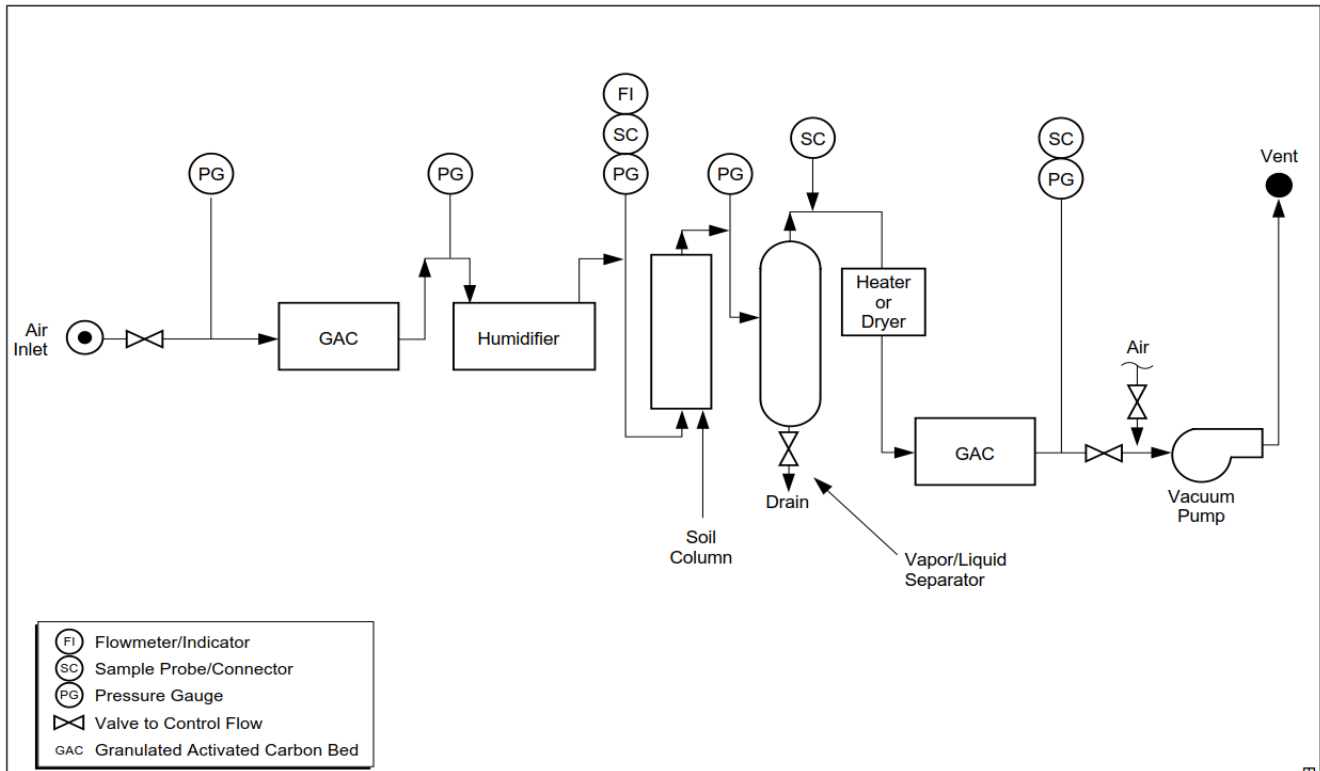

Figuur 3.3- Schema van een kolomtestopstelling

Figuur 3.4 geeft de voordelen en beperkingen van kolomproeven weer. Hoewel kolomproeven over het algemeen niet als enige bron van luchtdoorlaatbaarheidsgegevens mogen worden gebruikt, kunnen zij een nuttige aanvulling vormen op de in situ luchtdoorlaatbaarheids-testen.

Terwijl bijvoorbeeld in situ luchtdoorlaatbaarheids-testen gewoonlijk slechts op een beperkt aantal plaatsen kunnen worden uitgevoerd, kunnen intacte kernen vaak op vele plaatsen en diepten worden verzameld, ook binnen de in situ luchtdoorlaatbaarheids-testplaatsen, zodat de correlatie tussen laboratorium- en in situ-gegevens kan worden onderzocht. Als de resultaten goed gecorreleerd zijn, kunnen de laboratoriumgegevens worden gebruikt om de in situ-resultaten in het hele bemonsteringsgebied te generaliseren.

Advantages	Limitations
1. May accelerate the SVE process to permit evaluation of maximum contaminant removal potential.	1. Stripping air always has good access to the contaminants throughout the column. Airflow to different zones varies widely in the field.
2. Gives order-of-magnitude information on the partition coefficients needed for mathematical modeling.	2. Diffusion processes are often not properly modeled.
3. Order-of-magnitude air permeability measurements may be obtained with "undisturbed" samples.	3. Due to the differences in scale and airflow vs. core orientation, more representative air permeability results must be obtained through field air permeability measurements.
4. Can permit analysis of closely spaced samples.	4. Standard procedures must be formulated and validated.

Figuur 3.4- Voordelen en beperkingen van de kolomtest

Kolomproeven worden bij voorkeur uitgevoerd met intacte boormonsters. Intacte boormonsters kunnen worden verkregen met behulp van steekapparaten voor schijfbemonstering of continu-steekapparaten. De

steekmonsters moeten worden verzameld in stevige hulzen en moeten worden voorzien van de monsteraanduiding en -richting. De monsters moeten bij het verzamelen worden verzegeld en gekoeld om vervluchtiging en degradatie van verontreinigende stoffen te voorkomen. Bij typische boorprocedures worden bodemmonsters verticaal of bijna verticaal genomen. De typische luchtstroom tijdens bodemlucht-extractie is, hoewel hij driedimensionaal is, niet verticaal; de horizontale luchtdoorlaatbaarheid is waarschijnlijk van groter belang. Dit feit moet zorgvuldig worden afgewogen bij de beslissing of verticale boorkernen voor testen moeten worden verzameld.

In het laboratorium kunnen de boorkernen uit de boor in de kolom worden gebracht, of kunnen de monsterhulzen in de kolomopstelling worden opgenomen. Indien gestoorde monsters werden verkregen, moeten de monsters worden herverpakt tot een dichtheid die de veldomstandigheden benadert. Als de proef zo is opgezet dat verticale stroming door een gelaagd profiel wordt gesimuleerd, kunnen de lagen worden aangebracht tijdens het plaatsen van de grond. Men moet overwegen intacte, horizontaal georiënteerde kernen te verzamelen indien de proef bedoeld is om horizontale luchtstroming te simuleren.

De testapparatuur omvat meestal een vacuüm- of luchttoevoersysteem, debietmeters en drukmeetapparatuur. Apparatuur voor het meten van het bodemvochtgehalte (bijvoorbeeld tensiometers) kan eveneens aanwezig zijn. Alle verbindingen tussen het luchttoevoersysteem, de wanden van de kolom en het bodemmonster moeten luchtdicht zijn. Sommige kolommen zijn voorzien van een opblaasbare blaas in de annulus tussen het kernmonster en de kolomwand, om lekkage langs de zijkanten van het bodemmonster te voorkomen. Concentraties van verontreinigende stoffen kunnen worden gemeten in de vaste fase of in de bodemluchtfase. Aangezien voor bodemmetingen destructieve bemonstering nodig is, zijn de meetpunten beperkt tot de begin- en eindconcentraties. Bodemlucht-bemonstering maakt tijdreksmetingen van effluentconcentraties mogelijk, maar vereist doorgaans geavanceerde meetapparatuur ter plaatse (bijvoorbeeld gaschromatografen). Bodemluchtmetingen moeten worden gestaafd met begin- en eindconcentraties in de bodem.

De testresultaten worden meestal uitgedrukt als verontreinigings-concentratie versus het totale volume van de uitgewisselde lucht. Om kolomproeven te relateren aan toepassingen in het veld, wordt de luchtuitwisseling meestal uitgedrukt in aantallen uitgewisselde poriënvolumes.

Voor de berekening van de aantallen uitgewisselde poriënvolumes moeten de porositeit en de afmetingen van het monster worden gemeten, alsmede het debiet en de verstreken tijd. De resultaten kunnen worden gebruikt om de verwijderingssnelheid van de verontreiniging en de geschatte restconcentraties te bepalen. Verdelingscoëfficiënten kunnen ook worden bepaald, op voorwaarde dat de evenwichtsconcentraties gelijktijdig in elke fase worden gemeten, samen met de fractie organisch koolstof (foc).

### 3.3 Haalbaarheidsoverweging Bodemlucht-extractie

- Verontreinigingen met lage constanten van de Wet van Henry zijn moeilijk te behandelen via Bodemlucht-extractie. Onder bepaalde omstandigheden kunnen thermische verbeteringen van Bodemlucht-extractie worden overwogen om de vluchtigheid te verbeteren via injectie van hete lucht, stoom of andere technologieën voor ondergrondse verwarming.
- Bodemlucht-extractie is niet effectief in de verzadigde zone, en de schermen van de onttrekkingsputten moeten zodanig worden geplaatst dat rekening wordt gehouden met seizoensgebonden variaties in de grondwaterspiegelstijging. Op sommige locaties kan een verlaging van de grondwaterspiegel door middel van pompen worden overwogen om meer media bloot te stellen aan behandeling door middel van Bodemlucht-extractie.

- Bij het ontwerp van het systeem moet rekening worden gehouden met het geologische kader en de mate van laterale en verticale heterogeniteit, om ervoor te zorgen dat de bodemlucht daadwerkelijk uit alle delen van het doelinterval wordt verwijderd. Het is bijvoorbeeld gemakkelijker om stroming door een zandig interval te induceren dan door een slib- of kleilaag. Ook kan een kleilaag de bodemluchtextractie in delen van het verontreinigde interval belemmeren als een put niet op een zodanige manier is gescreend dat daarmee rekening wordt gehouden.
- Grond met een hoog percentage fijne deeltjes en een hoge mate van waterverzadiging vereist hogere zuigvermogens, hetgeen de kosten verhoogt en/of de doeltreffendheid en uniformiteit van de behandeling belemmert.
- Bodem met sterk wisselende permeabiliteit of stratificatie kan resulteren in ongelijkmatige extractie van de gasstroom uit verontreinigde zones. Nadat een Bodemlucht-extractie-systeem (tijdelijk of permanent) is stilgelegd, kan dit ook resulteren in het terugkaatsen van verontreinigende stoffen uit zones met een lagere permeabiliteit waar de massa-overdrachtsprocessen in de loop der tijd minder effectief waren. Bij het ontwerp en de plaatsing van extractieputten en/of Bodemlucht-extractie-operaties (bv. cyclische werking van extractieputten, pulserende werking), alsook de eventuele noodzaak van breukvorming, moet wellicht rekening worden gehouden met variërende doorlaatbaarheden/ gelaagdheid en de mogelijkheid van terugkaatsing.
- Het ontwerp van een Bodemlucht-extractie-systeem moet het mogelijk maken de luchtstroom en de concentraties van verontreinigende stoffen voor de afzonderlijke extractieputten te meten (in tegenstelling tot samengestelde metingen aan de aanjager). Het uitsluiten van metingen van individuele putten zal geen goede evaluatie of optimalisatie van de prestaties mogelijk maken. Bij heterogene lithologie is het niet ongevoond dat één of enkele van de extractieputten die op een meer doorlatende plaats zijn gescreend bijna de totale luchtstroom voor hun rekening nemen. Naarmate het verwijderingspercentage van de verontreiniging in de loop van de tijd afneemt, wordt de optie om afzonderlijke extractieputten met een lager verwijderingspercentage van de verontreiniging te pulsen of stil te leggen, interessant.
- De installatie van vacuümmeetpunten wordt aanbevolen voor een representatief aantal locaties in de hele behandelingszone, alsook voor afstanden tot de extractieputten, en diepten binnen verschillende bodemeenheden voor diepere behandelingszones. Vacuümmetingen op een voldoende aantal gassondes maken een overzichtelijke extrapolatie mogelijk van de luchtstroomsnelheden en distributiepatronen in de hele behandelingszone. Metingen van de ademhaling (bv. zuurstof) en de concentratie van verontreinigende stoffen kunnen ook worden verzameld om de invloed van de aanvulling en de voortgang van de verwijdering te evalueren, en om potentiële "dode zones" van ineffectieve behandeling te identificeren die mogelijk verder moeten worden geoptimaliseerd.
- Waterinfiltratie door regenval en/of grondwaterstijging in het Bodemlucht-extractie-systeem kan verschillende operationele problemen opleveren. Om verstopping van de leidingen te voorkomen, moeten de transferleidingen schuin worden teruggeleid naar de onttrekkingsputten of naar strategisch gelegen verzamelpunten. Het aanzuigen van grotere hoeveelheden ondiep grondwater of het meesleuren van neerslag die in het systeem is geïnfilteerd, kan de lucht/waterafscheider overweldigen en ernstige corrosie en vastlopen van de interne onderdelen van de blower veroorzaken (die dan moeten worden vervangen). Tijdens periodes van hevige regenval of ondiep grondwater kan het nodig zijn het Bodemlucht-extractie-systeem uit te schakelen of de onderdruk/luchtstroom te reduceren om deze problemen te voorkomen.
- Behandeling van afgassen is vaak vereist en zal de kosten van Bodemlucht-extractie-activiteiten aanzienlijk verhogen. Restvloeistoffen moeten bijvoorbeeld worden behandeld/verwijderd, afgewerkte GAC moet worden geregenereerd of verwijderd, en thermische/katalytische oxidatie kan aanzienlijke elektriciteits- en gaskosten met zich meebrengen. De langetermijnplanning van het project moet voldoende flexibiliteit bieden om de luchtbehandeling uit te schakelen of stop te zetten naarmate de

concentraties verontreinigende stoffen in het influent na verloop van tijd afnemen (bv. gebruik van gehuurde apparatuur, frequente monitoring van het influent ten opzichte van de vergunningsvereisten voor behandeling).

- De effectiviteit van de Bodemlucht-extractie heeft de neiging om in de loop van de tijd af te nemen en uiteindelijk een asymptotische/plateauwaarde te bereiken. Asymptotische/plateaustandigheden kunnen een artefact zijn van verontreinigingsmassa-verwijdering uit voornamelijk de zones met een hogere permeabiliteit, terwijl problemen worden ervaren met verontreinigingsmassa-verwijdering uit zones met een lagere permeabiliteit, gebieden met een hogere vochtigheid of een hogere adsorptie van verontreinigende stoffen aan de bodemmatrix. Een verdere evaluatie van het ontwerp en de werking van het Bodemlucht-extractie-systeem wordt aanbevolen indien dit zich op een bepaalde locatie voordoet. De impact die persistente concentraties van verontreinigende stoffen kunnen hebben op grondwaterconcentraties of bodemluchtintrusie moet worden geanalyseerd met behulp van geschikte modelleringsinstrumenten. Rebound-testen en bodemluchtconcentratie metingen op vacuümmeetpunten moeten worden uitgevoerd om de residuele verontreinigingsniveaus in het hele behandelingsgebied te evalueren teneinde een gefundeerde beslissing te kunnen nemen over de noodzaak van verdere optimalisering of uitschakeling van het systeem.
- De effectiviteit van een Bodemlucht-extractie kan worden verhoogd door het gebruik van pulserende werkingsschema's. Wanneer het systeem is uitgeschakeld, kunnen verontreinigingen in de poriënruimte diffunderen en vervolgens worden uitgeveegd wanneer het systeem actief is.
- De temperatuur van het afvoergas kan de behandelingsmogelijkheden beperken. Er moet zorgvuldig worden nagedacht over de integratie van warmtewisselaars om de temperatuur vóór de behandeling te verlagen.

## 4 IN VELD TEST

Voor Bodemlucht-extractie-toepassingen is het van cruciaal belang om de ondergrond adequaat te karakteriseren vanuit het oogpunt van luchtstroming. Hoewel voorspelling van de werkelijke luchtverdeling op dit moment niet uitvoerbaar is, kunnen de grove kenmerken van de luchtverdeling worden voorspeld voor eenvoudige geologieën (bv. zeer doorlatende en homogene omgevingen en omgevingen met grote heterogeniteiten op macroschaal zoals kleilagen in verder zandige bodems), en daarom is de kennis die wordt verkregen door visuele beoordeling van bodemkernen vaak van onschatbare waarde voor Bodemlucht-extractie-toepassingen.

Aan het eind van de locatiekarakteriseringsfase en voorafgaand aan de screening- en de proeffase moeten de locatiekarakteriseringsgegevens worden gebruikt om een beoogde behandelingszone af te bakenen en een conceptueel model voor de luchtverdeling op de locatie voor te stellen.

De Bodemlucht-extractie-proeftest moet betrouwbare gegevens opleveren voor het definitieve systeemontwerp op het gebied van

- de doelbehandelingszone bepalen;
- een conceptueel model voor de luchtverdeling in de behandelingszone voor te stellen;
- duurzame luchtstroomsnelheden;
- totale gaswinning;
- verwachte percentages verwijderde verontreinigde bodemlucht;
- voorkeursrichting van de luchtstroom onder de grond;
- de effectieve invloedstraal en bepalen of de onderlinge afstand tussen de injectieputten kostenverhogend is, en zo ja, de minimale afstand tussen de injectieputten bepalen die niet kostenverhogend is;
- de diepte, de locatie en de constructie van de putten voorstellen;
- aantal benodigde bodemlucht-extractieputten;
- bodemlucht-behandelingstechnologie voor afgassen van systemen.

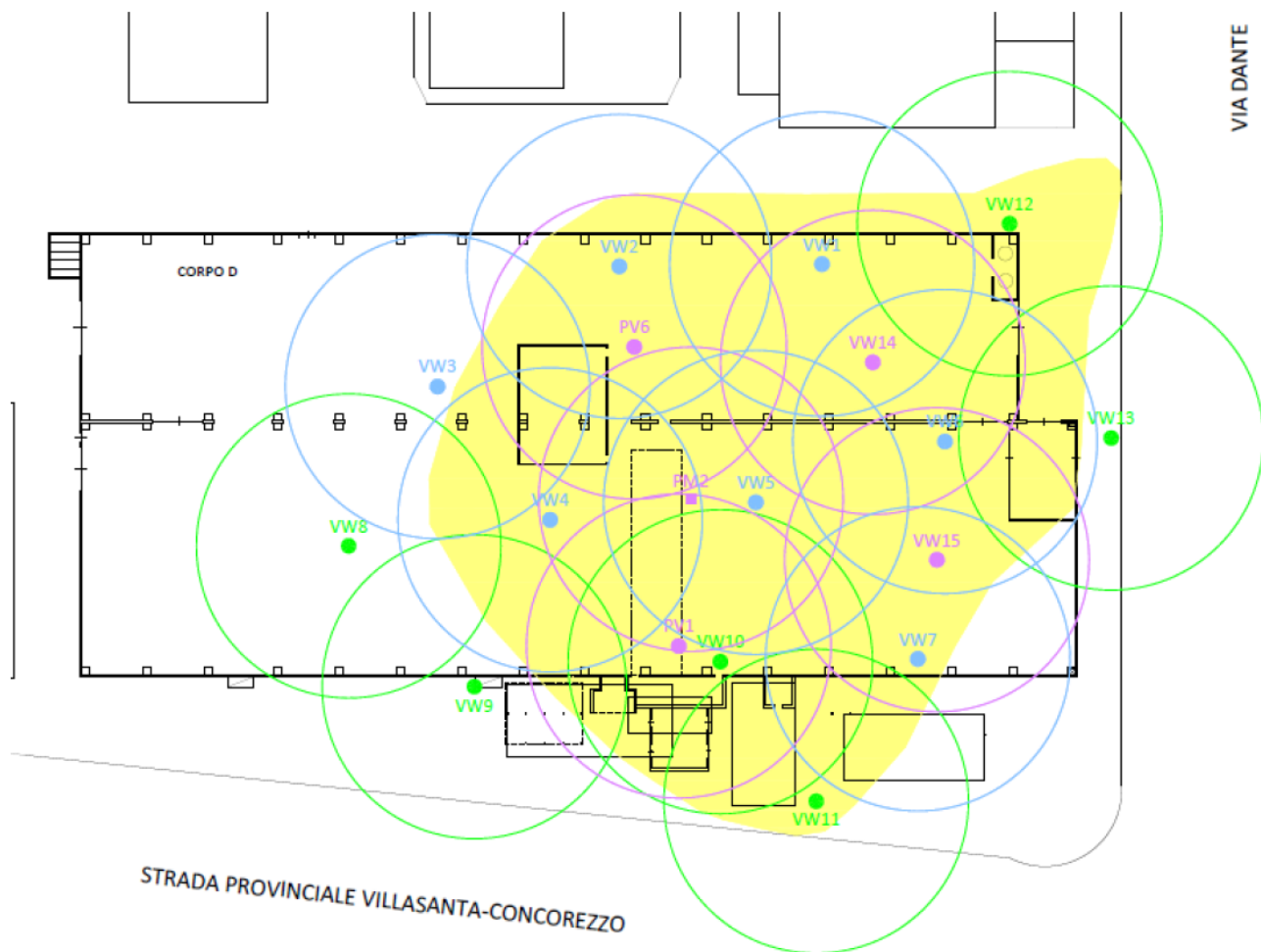

Figuur 4.1- Invloedsfeer na de proef (Confalonieri et al., zie bijlage 1)

De belangrijkste bepalende factoren voor deze bodemlucht-extractie-ontwerpparameters zijn (1) de aard en omvang van de verontreiniging in de bodem, (2) de doorlaatbaarheidssverdeling (d.w.z. heterogeniteiten) in de bodem, en (3) de verontreinigingsconcentraties in de onttrokken bodemlucht. Verwacht wordt dat deze informatie beschikbaar zal zijn op basis van een zich ontwikkelend conceptueel locatiemodel.

Naast het verstrekken van gegevens voor het ontwerp van het systeem op ware grootte, moet een naar behoren uitgevoerde proeftest de adviseur helpen bepalen of de bestaande tijdslimieten voor de afsluiting van het project kunnen worden gehaald, gezien de haalbare bodemlucht-verwijderingspercentages.

ACTIVITEIT	BEANTWOORDE VRAAG/VRAGEN
Injectiedruk/-stroomdichtheidstest	Is het mogelijk om het gewenste debiet te bereiken bij redelijke druk?
Helium tracer test	Wat is bij benadering de laterale omvang van de luchtverdeling? Zijn er aanwijzingen van voorkeursrichtingen?
Bodemlucht/afgas bemonstering	Wat is de vervluchtigingsgraad? Zijn er duidelijke veiligheidsrisico's?
DO metingen	Wat is bij benadering de laterale omvang van de luchtverdeling? Zijn er aanwijzingen van voorkeursrichtingen?



## 4.1 Conventionele proeftest

Conventionele gegevens over de locatiekarakterisering zijn belangrijk voor de evaluatie van bodemlucht-extractie; deze gegevens zijn echter vrij statisch en leveren geen adequate gegevens op voor een ontwerp op ware grootte. Met name het dynamische gedrag van de extractie van de massa aan verontreinigende stoffen is moeilijk te voorspellen zonder een proef met bodemlucht-extractie uit te voeren. Het onttrekkingsgedrag wordt grotendeels bepaald door het volume verontreinigde grond, de fracties van het bodemvolume waarin transport als advection versus diffusie kan worden gekarakteriseerd, de massaoverdrachts-karakteristieken van de diffusiebegrensde bronzones, de locatie van onttrekkingsschermen ten opzichte van bronnen en de aanwezigheid van puur product. In de volgende bespreking wordt geen rekening gehouden met puur product, hoewel een zone met een persistente concentratie die na meerdere perioden van extractie terugkeert naar een vrijwel identieke evenwichtsconcentratie een indicator van de aanwezigheid van puur product is.

Hoe vroeger in het saneringsplanningsproces (bij voorkeur als onderdeel van de karakterisering van de locatie) proeftesten worden uitgevoerd, hoe kleiner de kans dat het ontwerp na de inbedrijfstelling van het systeem moet worden aangepast. Vooral op grotere, complexere locaties zijn proeftesten aan te bevelen.

Bij het ontwerpen van de proeftest moet een gewenste totale bodemluchtwinningsnelheid of winningsduur worden vastgesteld. Idealiter wordt met de proeftest het equivalent van één of meer volledige porievolumes bodemlucht aan de verontreinigde bodem onttrokken. Het doel van deze test is het systeem lang genoeg te laten werken om de aanvankelijke afname van de geëxtraheerde VOS-concentratie en de concentratievermindering in bodemluchtsondes op verschillende afstanden te meten. Dit levert een eerste schatting op van de massa-overdrachtsbeperkingen en de straal van effectieve sanering vanuit één put [DiGiulio and Varahan, 2001a]. Als vuistregel kunnen de snelheid en de duur van de proeftest als volgt worden gebaseerd op het totale volume ( $V$ ) verontreinigde bodem in het conceptuele terreinmodel, de porositeit van de bodem, en het bodemvochtgehalte:

$$Q = V_{soil} (1-S)$$

De TCE-concentraties in de bodemlucht gedurende 3 dagen extractie met  $64 \text{ Nm}^3/\text{uur}$  in een put die dicht bij het centrum van een vermoedelijke bronzone voor TCE-dampen was geplaatst, worden getoond in onderstaande figuur. De geëxtraheerde concentratie nam in de eerste uren van de extractie snel af overeenkomstig de geschatte extractie- en uitwisselingsnelheid van de bodemlucht. De TCE-concentratie vertoonde vervolgens een veel langzamere afname tijdens de daaropvolgende extractie, wat in verband wordt gebracht met diffusieve massaoverdrachts-beperkingen in een insluitende klei-eenheid in het midden van de onverzadigde zone. Deze waarnemingen wijzen erop dat het proefstelsel voldeed om als volwaardig systeem te kunnen functioneren op deze kleine locatie. Het gebruik van actieve kool voor de behandeling van afgassen bleek ook kosteneffectief te zijn.

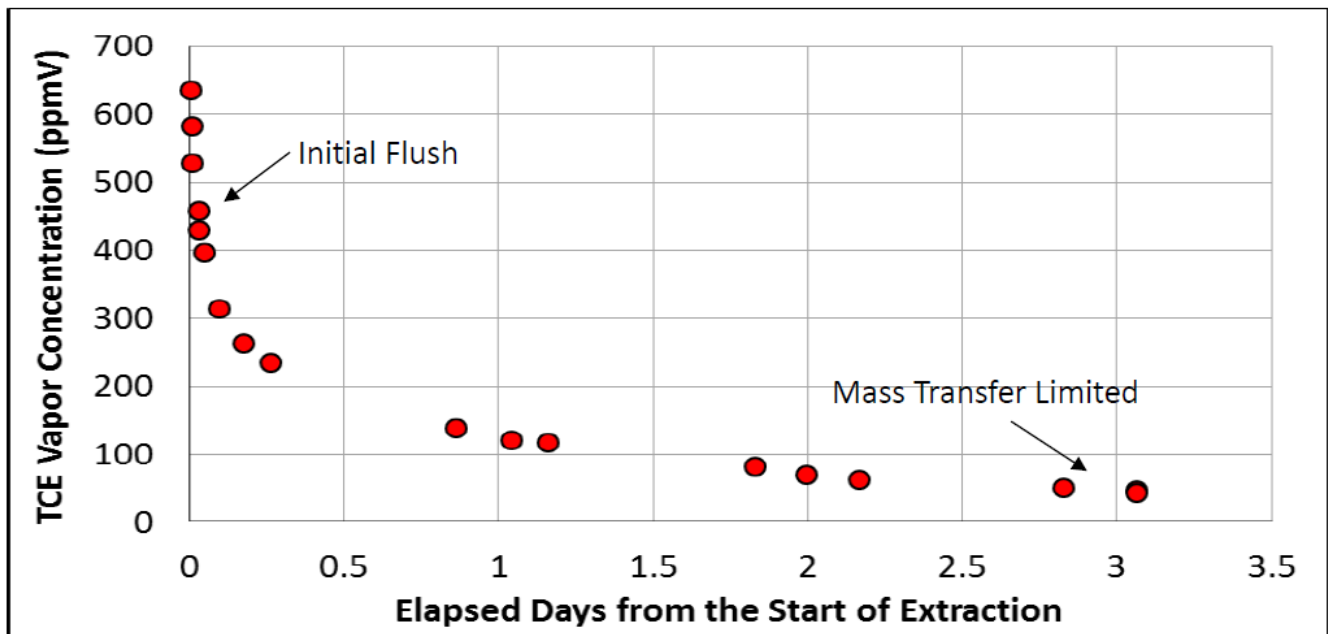

Figuur 4.2- Voorbeeld van bodemlucht-concentraties van een Bodemlucht-extractie-proeftest

Bij een lagere doorlatendheid van de bodem kan een tweede put nodig zijn geweest om de gewenste doorstroming te bereiken of kan een langere doorspoelperiode nodig zijn geweest om de massa-overdrachtsbeperkingen vast te kunnen stellen. Zoals later beschreven, werd aanvullende informatie over de massa-overdrachtsbeperkingen verkregen door de weer oplopende TCE-concentratie in de bodemlucht bij de put te meten nadat de extractie was beëindigd. Bovendien, als de TCE-concentratie in de bodemlucht aanvankelijk hoger was en na de afname in het begin op een aanzienlijk hogere waarde bleef, wat zou duiden op het bestaan van een zaklaag, zou koolstofadsorptie mogelijk niet kosteneffectief zijn geweest voor de hogere massa-extractiesnelheid.

Er kunnen ook meetpunten worden geïnstalleerd op verschillende diepten, inclusief meetpunten onder bebouwing of verharding (indien van toepassing) en binnen het invloedsgebied (bv. 3-15 m) van een proefextractieput, indien deze nog niet beschikbaar zijn op basis van eerdere locatielocatiekarakteriseringsactiviteiten. Elke monitoringlocatie kan, afhankelijk van de diepte tot het grondwater en de geologische gelaagdheid, over de verticale breedte van de onverzadigde zone meerdere gecombineerde meetpunten hebben.

Zoals geïllustreerd in onderstaande figuur, kunnen meetpunten boven, onder en binnen verdachte bronnen worden geplaatst. Tijdens proeftesten worden deze locaties gebruikt om zowel de bodemlucht-concentratie als de vacuümrespons te meten.

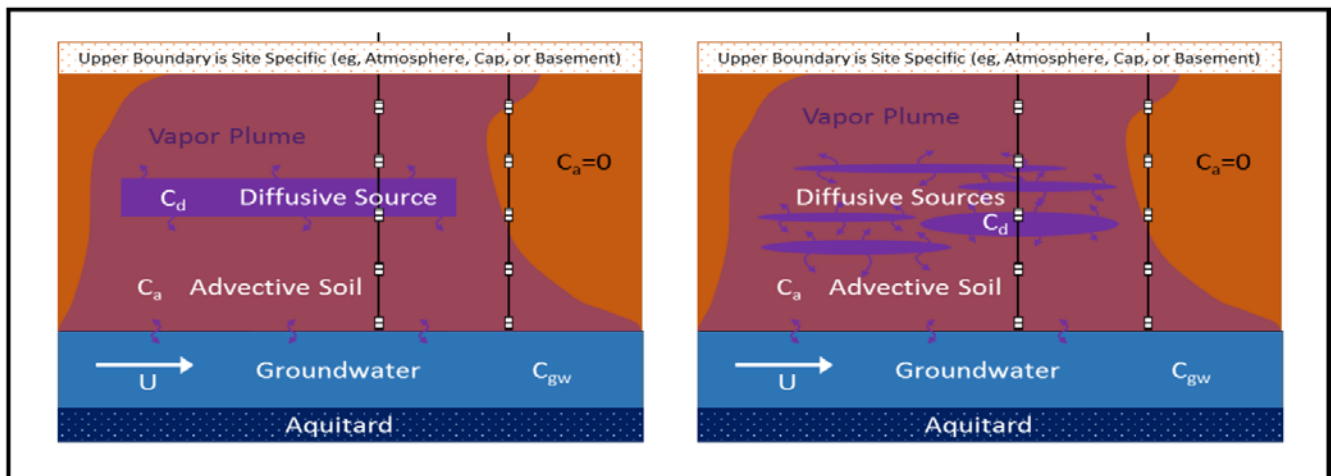

Figuur 4.3- Conceptuele scenario's voor diffusie-beperkte massaoverdracht en typische bodemluchtmeetpunten

De bruikbaarheid van vacuümgegevens is sterk afhankelijk van de doorlatendheid van de bodem en de gegevens kunnen niet worden gebruikt om de invloedstraal voor bodemlucht-extractie te bepalen. Van groter belang is de verandering van de bodemlucht-concentratie. In doorlatend zand kan een zeer kleine vacuümrespons worden geassocieerd met een relatief grote luchtstroom, terwijl een aanzienlijke vacuümrespons in klei geen bewijs oplevert dat er een merkbare stroming met het vacuüm is geassocieerd. De vacuümmeetgegevens kunnen echter worden gebruikt om de laterale versus verticale omvang van de stroming en het effect van oppervlakte-omstandigheden op de spoeling van de bodemvolumes aan de oppervlakte te beoordelen. Voorbeelden van dergelijke oppervlakte-omstandigheden zijn lekkage met lage doorlaatbaarheid over een verhard bodemoppervlak of een bodemoppervlak in directe verbinding met de atmosfeer)

Tijdens de proeftesten wordt een degelijk bewakingsprogramma voor de VOS-concentratie in de lucht aanbevolen om trends in de bodemlucht-metpunten vast te stellen. Deze trends kunnen worden gecorreleerd met het poriënvolume van de tijdens de proeftest behandelde bodem om een basis te verschaffen voor de onderlinge afstand van de extractieputten in het ontwerp op ware grootte, op basis van de gewenste doorstroom-frequentie (d.w.z. poriënvolume-uitwisselingssnelheid), zoals besproken in de volgende paragraaf. Het gebruik van een veldgaschromatograaf door een ervaren operator wordt aangemoedigd om de omvang van de VOS-dataset voor bodemlucht op kosteneffectieve wijze te vergroten.

Vaak is de directe lozing van afgasen zonder behandeling onaanvaardbaar om gezondheids-, veiligheids- of publieke redenen. Indien de omstandigheden dit vereisen, kunnen technologieën voor de behandeling van afgasen, zoals behandeling met actieve kool, thermische oxidatie of andere relevante technologieën, worden toegepast om de kwaliteit van het afgas met het oog op lozing in de atmosfeer te verbeteren.

#### 4.1.1 Conventionele proeftest-apparatuur

De uitrusting van de Bodemlucht-extractie-proeftest kan bestaan uit de volgende instrumenten [Farallon 2019], of gelijkwaardig:

- Een op een slede gemonteerde regeneratieve ventilator van ten minste 1 pk (gelijkwaardig aan een Rotron DR 404) die in staat is tot een waterkolomvacuüm van 50 inch en een debiet tot 105 standaard kubieke voet per minuut.
- Een vochtafscheider met een vacuümindicator, een vacuüm-overdrukklep en een aftapkraan.

- Een verdeelblok bestaande uit een reeks kleppen, vacuümindicatoren en een debietmeter die een extractie-luchtdebiet variërend van 0,66 tot 100 standaard kubieke voet per minuut en een vacuüm van 0,1 tot 80 inch waterkolom kan controleren.
- Rubberen, flexibele koppelingen, flexibele slangen en/of Schedule 40 polyvinylchloride-fittingen om apparatuur van de bodemlucht-extractie-extractieput aan te sluiten op een bodemlucht-uitlaatpunt.

De observatieputten moeten voorzien zijn van vacuümdichte aansluitingen die eindigen in een kogelkraan voor aansluiting op een vacuümmeter voor de bewaking van het waargenomen vacuüm gedurende de activiteiten van het proefonderzoek. In onderstaande figuur is een schema van het proces en de instrumentatie opgenomen.

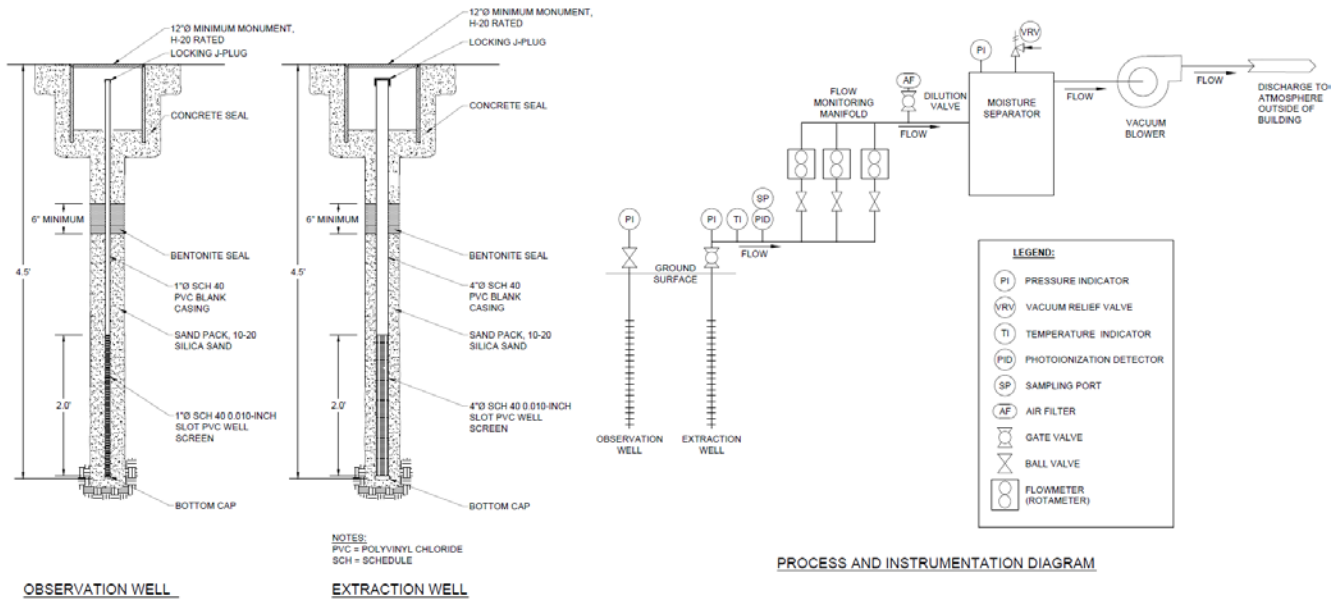

Figuur 4.4- Voorbeeld van proces- en instrumentatieschema (Farallon Consulting)

#### 4.1.2 Bodemlucht-extractie toenemende vacuümstap-test

De bodemlucht-extractie proeftest moet worden uitgevoerd als een stappentest met ten minste drie luchtdebietstappen. De duur van elke teststap moet minstens even lang zijn als de tijd die nodig is om de parameters die worden gemeten op de vacuümcontrolepunten in een stabiele toestand te brengen. Terwijl het debiet en het vacuüm in de bodemlucht--extractieput constant worden gehouden (er moeten frequente metingen worden verricht om deze toestand te garanderen), moeten drukmetingen worden verricht in de extractiesput en op alle bodemvacuüm-meetpunten. De metingen moeten in het begin van de proefperiode frequent worden uitgevoerd (om de vijf à tien minuten); het tijdsinterval tussen de vacuümmetingen kan in de loop van de test toenemen.

Voor de proeftest worden minimaal één bodemluchtextractieput en drie vacuüm-meetpunten, op verschillende afstanden van de extractieput, aanbevolen. Specifieke bodemlucht-extractieputten en -meetpunten worden aanbevolen, maar grondwatermeetputten kunnen bruikbaar zijn als de locatie en de constructie ervan geschikt zijn voor de locatie. De goedkeuring van het gebruik van grondwaterpeilbuizen voor Bodemlucht-extractie-onttrekkingsputten of -meetpunten zal plaatsvinden op locatiespecifieke basis. Als algemene regel geldt dat de vacuüm-monitoringpunten moeten worden geplaatst op een afstand van vijf tot

tien voet, tien tot twintig voet, twintig tot veertig voet en meer dan veertig voet van de put voor de onttrekking van bodemlucht. De vacuüm-meetpunten moeten radiaal ten opzichte van de bodemlucht-extractieput worden geplaatst in plaats van in een lijn (d.w.z. met een tussenafstand van 120° voet), om de mogelijke preferentiële luchtstromingsbanen op de locatie beter te kunnen evalueren. Als de bodemverontreiniging zich uitstrekt over meerdere bodemlagen met een verschillende doorlaatbaarheid, moet elke afzonderlijke bodemlaag worden geëvalueerd met een eigen bodemlucht-extractieput en drie bodemlucht-meetpunten.

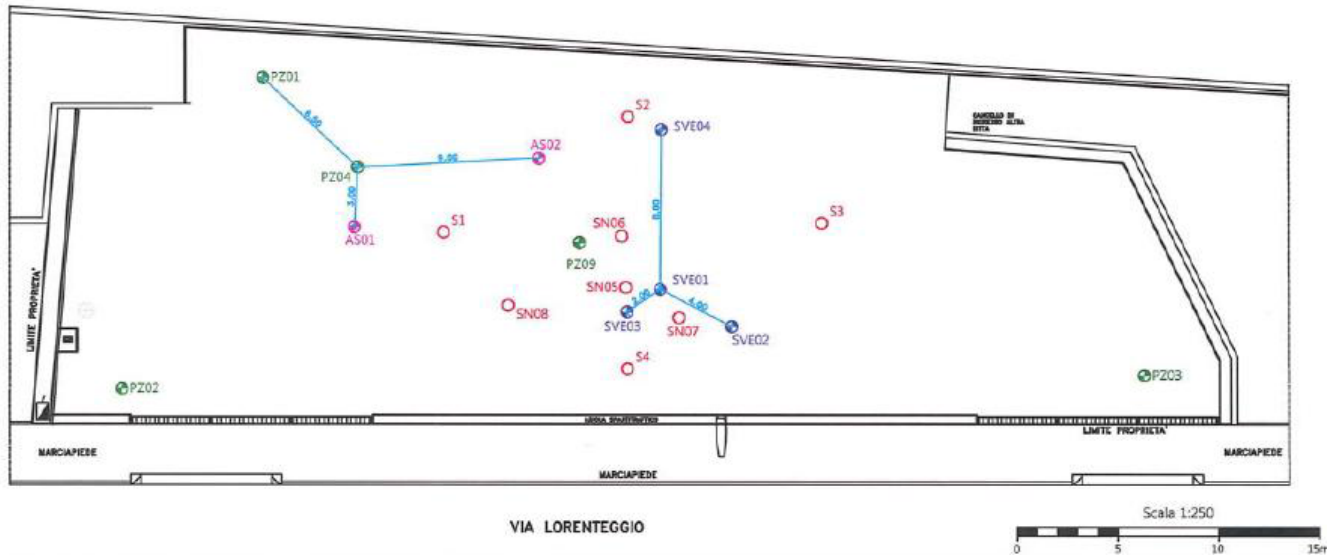

Figuur 4.5- Typische positionering op 120° van het bodemlucht-extractie-meetpunt (Confalonieri et al., zie bijlage 1)

Een typische luchtextractieput is een verticale put met een diameter van 1 tot 4 duim en een gescreend interval van 1 tot 5 voet, maar deze gegevens moeten worden bepaald op basis van de locatie.

Voorafgaand aan de uitvoering van de Bodemlucht-extractie-staptest zullen basislijn-vacuümmetingen worden verzameld in observatieputten. Tevens wordt een veldscreening op organische dampen aanbevolen, die moet worden uitgevoerd met een vlamionisatiedetector (FID) of een combinatie van een fotoionisatiedetector (PID) en een explosiemeter.

De Bodemlucht-extractie-staptest wordt uitgevoerd door het vacuüm van de bodemlucht-extractie-extractieput stapsgewijs op te voeren. De maximale hoeveelheid onderdruk die op de bodemlucht-extractie-onttrekkingsput kan worden uitgeoefend, is gebaseerd op de afstand van de bovenkant van het blootliggende putscherm tot de bovenkant van de grondwaterspiegel, of op de beschikbare apparatuur. Op basis van de blowercurve voor een regeneratieve blower met een vermogen van 1 pk, zal het verwachte maximale vacuüm dat op de bodemlucht-extractieput wordt toegepast 50 inch waterkolom bedragen [Farallon 2019]. De olopende stappen worden toegepast bij 30, 70 en 100 procent van het maximale vacuümvermogen van de blower. Tijdens elke fase van de stappentest moeten de volgende parameters met tussenpozen van ten minste 15 minuten worden gemonitord, totdat de criteria stabiliseren (minder dan 5 procent verschil tussen de gebeurtenissen) of voor een maximale duur van 2 tot 3 uur bij elke vacuümstap:

- vacuüm in de bodemlucht-extractie-extractieput;
- extractiedebiet van de bodemlucht-extractieput;
- temperatuur van de geëxtraheerde bodemlucht;
- metingen van vluchtige organische stoffen uit een geëxtraheerde bodemlucht-stroom met een fotoionisatiedetector;
- vacuüm in de observatieputten;
- de vacuümmetingen worden geregistreerd als manometer-drukmetingen.

minutes	Pid ppm	Lel %	O2 %	CO2 %	Depress mbar	V m/s	T °C	Q mc/h
<b>0</b>	480.1	18	21.3	1.22	-286.0	7.74	1.4	47
<b>10</b>	2147.0	16	21.5	3.45	-258.0	6.57	0.8	47
<b>30</b>	2371.0	13	20.9	3.16	-249.0	6.23	4	43
<b>60</b>	4106.0	13	20.9	2.7	-236.0	6.77	4.1	50
<b>90</b>	4469.0	10	20.9	2.26	-232.0	7.46	4.6	53
<b>120</b>	5000.0	10	20.9	2.08	-229.0	8.27	5.2	57
<b>180</b>	5000.0	9	20.9	1.83	-225.0	9.03	5.9	64
<b>240</b>	5000.0	9	20.9	1.62	-222.0	9.53	6.9	67
<b>300</b>	5000.0	8	20.9	1.44	-220.0	9.6	7	72

Figuur 4.6- Voorbeeld van een bewakingstabel (Confalonieri et al., zie bijlage 1)

Bodemluchtmonsters kunnen worden verzameld in Summa-bussen en/of Tedlar-zakken en/of een soortgelijke en gelijkwaardige drager, en aan het eind van elke stappentest voor laboratoriumanalyse worden verzonden bij de piekconcentratie van de extractie zoals gemeten met de fotoionisatie-detector.

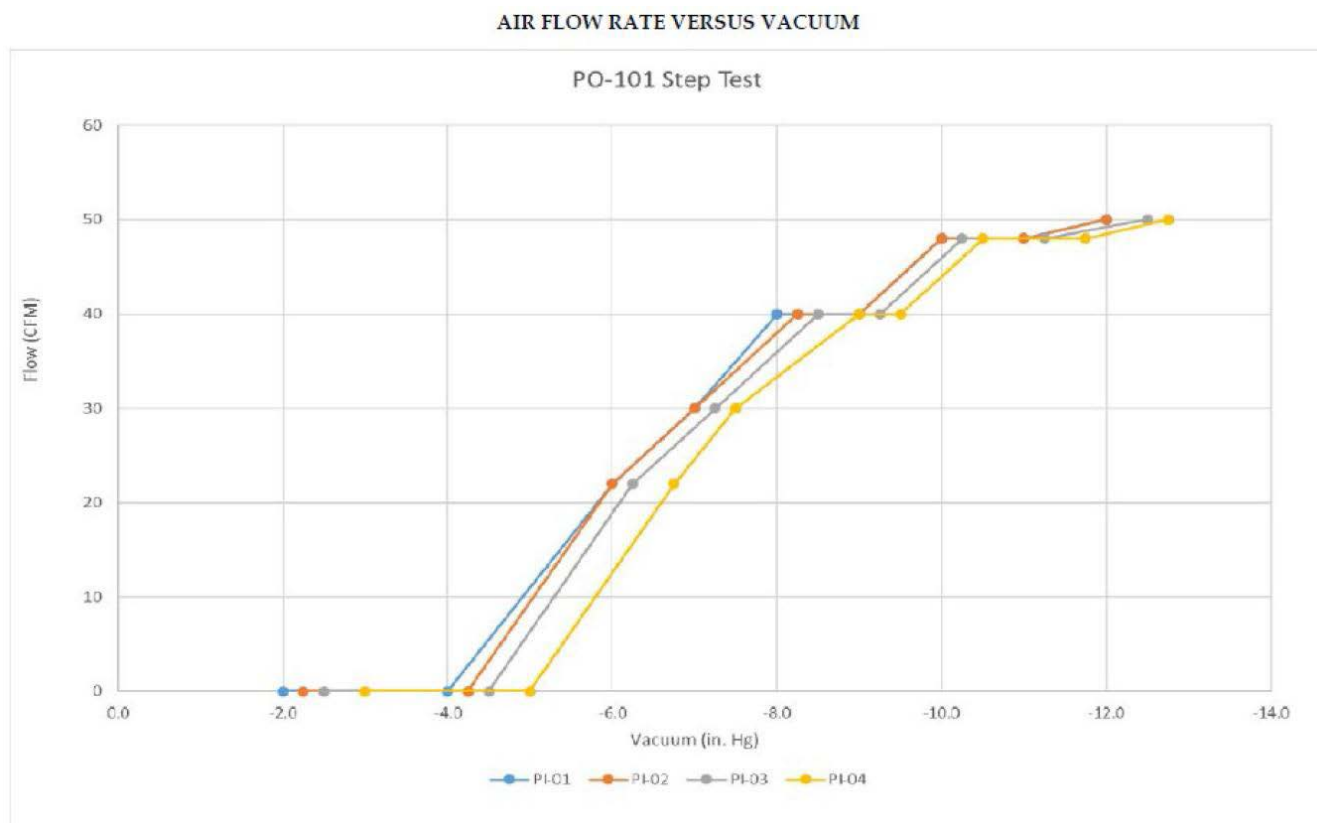

Figuur 4.7- Voorbeeld van een bodemlucht-extractie oplopende vacuümstaptest (Menozzi et al., zie bijlage1)



### 4.1.3 Bodemlucht-extractie constante vacuümtest

Op basis van de resultaten van de bodemlucht-extractie-staptest kunnen het ideale vacuüm en het ideale onttrekkingsdebiet worden vastgesteld om de bodemlucht-extractie constant vacuümtest, het tweede onderdeel van de bodemlucht-extractie proeftest, te voltooien. Het optimale vacuüm en debiet moeten worden bepaald op basis van het waargenomen vacuüm en debiet uit de onttrekkingsput, de bodemlucht-terugwinning, de bij de observatieputten waargenomen respons en de invloed op de grondwaterniveaus. Het optimale debiet kan ook worden bepaald op basis van de bij de stapsgewijze test bepaalde invloedstraal.

De bodemlucht-extractie constante vacuümtest moet onmiddellijk na de bodemlucht-extractie stappentest plaatsvinden en ongeveer 24 uur duren. De gecontroleerde testparameters voor de stappentest worden ook tijdens de bodemlucht-extractie constante vacuümtest met tussenpozen van 15 minuten gecontroleerd en geregistreerd:

- vacuüm in de bodemlucht-extractie-extractieput;
- extractiedebiet van de bodemlucht-extractie-extractieput;
- temperatuur van de geëxtraheerde bodemlucht;
- metingen van vluchtige organische stoffen uit een geëxtraheerde bodemlucht-stroom met een fotoionisatie-detector;
- vacuüm in de observatieputten;
- de vacuümmetingen worden geregistreerd als manometer-drukmetingen.

Het tijdsinterval voor de monitoring kan tijdens de proeftest worden gewijzigd op basis van waarnemingen in het veld. De langduriger bodemlucht-extractie-test met constant vacuüm draagt bij aan de evaluatie van de concentraties van emissies in stationaire toestand en van de luchtstroom en het vacuüm van de bodemlucht-extractie, die specifiek zijn voor de locatie.

Bodemlucht-monsters kunnen worden verzameld in Summa-bussen en/of Tedlar-zakken en/of soortgelijke en gelijkwaardige dragers, en na afloop van de bodemlucht-extractie-test met constant vacuüm voor laboratoriumanalyse worden opgestuurd.

## 4.2 Heliumdistributie en terugwinningstest

Hoewel een Helium-tracertest niet gebruikelijk is vanwege de beperkte aanvoer, is een van de sterke punten van deze test dat hij gemakkelijk kan worden herhaald, meestal met tussenpozen van in de orde grootte van slechts enkele uren. Hierdoor kunnen de effecten van procesveranderingen (bijvoorbeeld de verdeling van de luchtstroom uit verschillende putten) snel worden beoordeeld.

Helium is het meest gebruikte indicatorgas, omdat het relatief goedkoop en gemakkelijk verkrijgbaar is en er analytische instrumenten beschikbaar zijn voor gebruik in het veld. Gangbare detectoren kunnen heliumconcentraties van 0,1% tot 100% detecteren. Het is in de fabriek gekalibreerd, zodat het niet in het veld kan worden gekalibreerd, maar er moeten controles met helium-standaarden worden uitgevoerd om na te gaan of het instrument goed werkt. Gewoonlijk moeten bodemlucht-monsters worden verzameld in Tedlar-zakken of -bussen. De helium-detector wordt dan rechtstreeks aan de monsterhouder bevestigd voor de meting. Als alternatief kan de helium-detector worden aangepast om continu te bemonsteren. Continue bemonstering is erg handig bij het meten van bodemlucht-extractie off-gas waar een continue stroom beschikbaar is.

De hier beschreven tracer-terugwinningstesten kunnen worden uitgevoerd als onderdeel van een proeftest, of tijdens toepassing op ware grootte. De test is zeer eenvoudig uit te voeren en te interpreteren. In principe

wordt een inerte tracer (gewoonlijk helium) in de grond gebracht met een constante, bekende snelheid en wordt de concentratie van de tracer in de afgevoerde bodemlucht gecontroleerd. Na een bepaalde tijd (bijvoorbeeld een uur of minder voor veel systemen) begint de concentratie van de tracer in het afgevoerde gas te stijgen. De concentratie blijft stijgen en bereikt uiteindelijk een stabiel niveau. Het percentage van de afgevangen lucht kan worden berekend door de bodemlucht-extractie-stroomsnelheid te vermenigvuldigen met de heliumfractie in de bodemlucht, zodra de concentratie is gestabiliseerd en dat getal te delen door de tracer-injectiesnelheid, zoals hieronder weergegeven.

$$\%Recovery = \frac{SVE \text{ flowrate}}{Trace \text{ injection rate}} \times \% \text{ tracer in offgas} \times 100$$

%Terugwinning = bodemlucht-extractie-stroomsnelheid % tracer in afgevoerd gas 100

Een robuustere veldtechniek voor het berekenen van de terugwinning is het eerst meten van de "100% terugwinnings-concentratie" in het afgevoerde gas van de bodemlucht-extractie door het helium rechtstreeks in de bodemlucht-extractie-verdeelleiding te injecteren. (Er moet voor worden gezorgd dat het debiet in beide gevallen gelijk is, aangezien de tegendruk voor de twee systemen aanzienlijk verschilt). In dit geval is het terugwinnings-percentages eenvoudigweg de heliumconcentratie die in het afgevoerde gas van de bodemlucht-extractie wordt gemeten, gedeeld door de "terugwinningsconcentratie van 100%".

Indien helium als tracer wordt gebruikt, moet de injectie-concentratie onder 10% van het volume worden gehouden om opwaartse effecten in de onverzadigde zone te voorkomen. Om te zorgen voor een constante heliumstroom bij wisselende tegendruk moet een gekalibreerde debietmeter met directe aflezing worden gebruikt, samen met een manometer en een doseerventiel om een constante, hoge tegendruk bij de debietmeter te verkrijgen.

De terugwinning van de tracer is bedoeld als een "rode vlag" voor de prestaties van het systeem. Indien de terugwinning van helium laag is, is het mogelijk dat lucht (en helium) wordt ingesloten onder de waterspiegel in lagen met een lagere doorlaatbaarheid en zich lateraal verplaatst buiten het bereik van het bodemlucht-extractie-systeem.

In sommige gevallen is het mogelijk dat er geen helium naar de put terugkomt als gevolg van de aanwezigheid van continue lagen. De aanwezigheid van deze lagen moet ook kunnen worden vastgesteld door de grondwaterdruk tijdens het opstarten en afsluiten van het systeem te meten. Daarom wordt aanbevolen de helium-terugwinningsstest uit te voeren in combinatie met grondwater-drukmetingen.

Als de heliumterugwinning hoog is (bv. >80%), dan functioneert het bodemlucht-extractie-systeem goed en is het onwaarschijnlijk dat zijwaartse migratie van bodemlucht een probleem vormt.



### 4.3 Bodemluchtbewaking

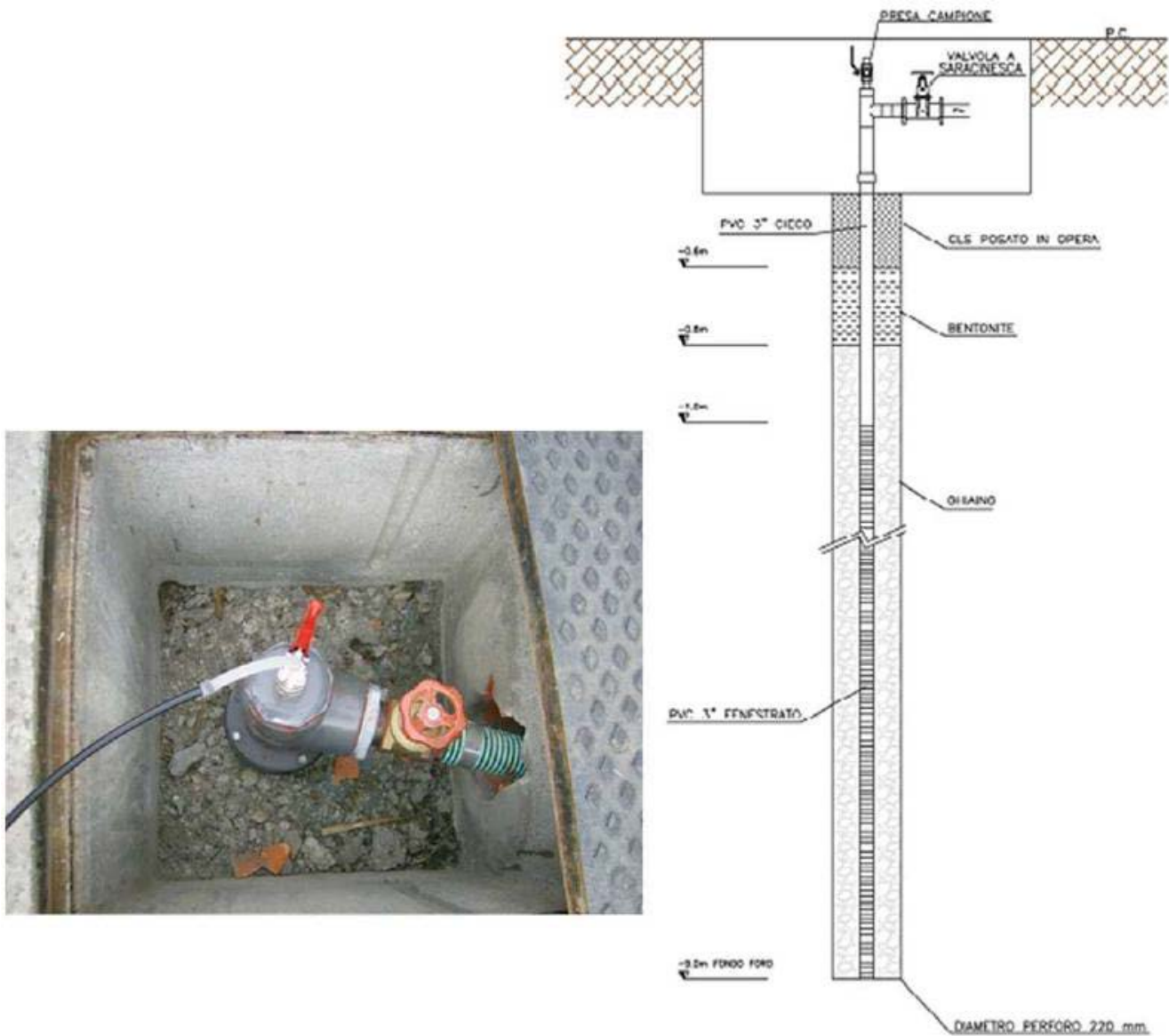

Figuur 4.8- Voorbeeld van de installatie van de Nesty-sonde (Trezzi et al., zie bijlage 1)

Tijdens de proeftest moeten bij elke debietstap bodemlucht-monsters worden genomen uit de bodemlucht-extractieput voor eventuele laboratoriumanalyse. De frequentie en het aantal monsters dat voor laboratoriumanalyse is bestemd, moeten worden gebaseerd op de specifieke omstandigheden ter plaatse; er moet echter minimaal één monster voor laboratoriumanalyse worden gebruikt dat is verzameld in de stap met de hoogste uitslag van het veldinstrument. Bodemlucht-monsters moeten worden genomen op het bodemlucht-onttrekkingspunt uit een monsternemingspoort die zich tussen de putkop en de ventilator bevindt. Voor het verzamelen van laboratoriummonsters voor VOS-, CO<sub>2</sub> en O<sub>2</sub>-analyses mag gebruik worden gemaakt van een tedlarzak, een houtskoolbuisje of een Summa-blikje, hoewel het laatste de voorkeur geniet. De analysemethode moet worden goedgekeurd door de technische staf van het project. Draegerbuizen worden algemeen gebruikt voor het meten van CO<sub>2</sub>, en kunnen ook geschikt zijn voor het monitoren van de

VOS-concentratie. Indien specifieke minimale rapportagevoorschriften niet kunnen worden verkregen ten gevolge van locatiespecifieke omstandigheden, moet dit worden toegelicht of besproken.

Stijgingen in de concentratie van verontreinigende stoffen in het afgevoerde gas en de bodemlucht- - extractiesnelheid kunnen worden gebruikt om een massa-verwijderingssnelheid te bepalen. Uiteraard zijn metingen die tijdens de korte duur van een proeftest zijn verricht, niet indicatief voor de prestaties op lange termijn. In het algemeen kan echter worden aangenomen dat de gegevens van de proeftest het maximale verwijderingspercentage van het systeem weergeven. Indien het massa-verwijderingspercentage tijdens (bijvoorbeeld aan het einde van) de proeftest te laag is, moet men zich ernstig zorgen maken over de levensvatbaarheid van bodemlucht-extractie op de locatie.

#### 4.4 Minimumuitrusting voor Bodemlucht-extractie-veldtest

Een proeftest voor een systeem voor bodemlucht-extractie omvat een extractieput die zich in het verontreinigde gebied bevindt, een soortgelijke put die zich in een gebied zonder aangetoonde verontreiniging bevindt, en een aantal overeenkomstige observatieputten. Andere belangrijke onderdelen van de proefconfiguratie kunnen zijn:

- een draagbare ventilator of vacuümextractor;
- putmonsterpoorten;
- meetinstrumenten voor de extractieputten;
- apparatuur voor monsterafname.

Gangbare meetinstrumenten zijn onder meer:

- een foto-ionisatiemeter (PID), die de hoeveelheid vrijkomende vluchtige verbindingen meet;
- een aantal vacuümmeters of luchtstroommeters om de invloedstraal voor elke extractieput te helpen bepalen;
- temperatuurmeters om de temperatuur van de bodemlucht te bepalen, die van invloed kan zijn op de totale luchtstroomsnelheid.

Monsteruitrusting kan omvatten:

- tedlarzakken en draagbare luchtpompen voor het verzamelen van monsters van influent of effluent;
- wegwerpbare hoosvaten voor het nemen van water- of productmonsters uit observatieputten.

#### 4.5 De extractieput

De extractieputten vormen een integraal onderdeel van een proeftest met een bodemlucht-extractie-reinigingssysteem. Deze putten zijn een manier om verontreiniging uit de onverzadigde zone te verwijderen door het creëren van een negatieve drukgradiënt. De verontreiniging wordt naar de onttrekkingsput "gezogen", omdat de druk bij de onttrekkingsput lager is. Bij elk saneringsplan dat gebruik maakt van bodemlucht-extractie als verwijderingstechniek gaat het erom de juiste mate in de drukgradiënt te bepalen. Een proeftest is een gebruikelijke manier om dergelijke informatie te krijgen.

Als er alleen monsters bij de extractieputten worden genomen, wordt natuurlijk een onvolledig beeld verkregen. Waarnemingen bij de winningsputten geven weliswaar informatie over de verandering van de omstandigheden op de plaats van winning, maar niet veel meer dan dat. Daarom zijn observatieputten zo belangrijk. Observatieputten, die op dezelfde manier worden gescreend als de overeenkomstige

onttrekkingsputten, leveren informatie op over bijvoorbeeld grondwaterfluctuaties, dampdrukgradiënten en zelfs veranderingen in de migratie van de verontreinigingspluim. Door regelmatig monsters te nemen en metingen te verrichten, zowel bij de observatie- als bij de onttrekkingsputten, kan men een vollediger en specifiek beeld krijgen dan elk van beide onderdelen afzonderlijk zou kunnen opleveren. Idealiter omvatten de metingen het grondwaterpeil zoals gemeten met een waterpeilindicator, de dikte van elk product in de vrije fase zoals gemeten met een interface-sonde, en de concentratie van VOS zoals bepaald met een foto-ionisatiemeter. De metingen moeten monsters omvatten van de luchtinlaat en -uitlaat van de apparatuur, en eventuele afgassen die verband houden met de voorgestelde behandeling van de onttrokken bodemlucht. Deze verzamelde monsters moeten in een laboratorium worden geanalyseerd op bijvoorbeeld VOS en het totaal aan petroleumkoolwaterstoffen (TPH). De specifieke analysebehoeften zullen van geval tot geval verschillen, dus het is aan te raden om contact op te nemen met de plaatselijke regelgevende instantie voor advies, indien nodig.

#### 4.6 Voorstel voor een proefproject - minimumvereisten voor indiening

1. Een beschrijving van de veldprocedures, de resultaten van de proeftest, inclusief de bepaling van de effectieve invloedstraal en van de samenstelling van de verontreiniging en de bodemluchtverwijderingssnelheden.

2. Statische (pre-test) gegevens:

- gegevens over het statische waterpeil (tot op 0,01 foot nauwkeurig) indien peilbuizen worden gebruikt als vacuümmeetpunten of bodemlucht-onttrekkingspunten;
- bodem- en luchttemperatuur;
- statische druk (inch H<sub>2</sub>O); en atmosferische omstandigheden (druk en temperatuur)

3. Testgegevens verzameld op het extractiepunt (gerapporteerd voor gespecificeerde tijdsintervallen):

- luchtdebiet;
- waterstandsverhoging tot op 0,01 ft nauwkeurig (indien peilbuis wordt gebruikt);
- VOC-, CO<sub>2</sub>- en O<sub>2</sub>-concentraties;
- FID-metingen (of PID en explosimeter);
- druk;
- bodem- en luchttemperatuur.

4. Testgegevens verzameld op het vacuümmeetpunt (gerapporteerd voor gespecificeerde tijdsintervallen):

- vacuüm (inches H<sub>2</sub>O);
- waterstand (tot op 0,01 foot nauwkeurig).

5. Cijfers

- plattegronden van het terrein (op schaal) waarop de ligging van het (de) brongebied(en), de winnings- en vacuüm-monitoringpunten, de gebouwen, de verharde oppervlakte en de greppels van de nutsvoorzieningen, de omvang van de bodem- en grondwaterverontreiniging en de grondwaterspiegel voor de dag van de proefproef zijn aangegeven;

- geologische dwarsdoorsneden van de locatie, ter illustratie van de belangrijkste geologische kenmerken, de verspreiding van verontreinigende stoffen en de plaats van de winnings- en monitoringpunten;
- constructieschema's van extractieputten en vacuümcontrolepunten;
- constructieschema ter illustratie van het ontwerp van de verzamelleiding, met inbegrip van de volgende elementen: leidingen, instrumenten, kleppen, bemonsteringspoorten en alle andere onderdelen van het proeftest-systeem.

#### 6. Grafieken:

- genormaliseerd vacuüm (controlepunt vacuüm/extractiepunt vacuüm) als functie van de afstand van het extractieputje voor elke stroomsnelheidstap (uitgezet op semi-logaritmisch papier);
- de toegepaste onderdruk (inch H<sub>2</sub>O) als functie van het luchtdebiet bij de extractieopening voor elke stap in het luchtdebiet;
- totale VOS-concentratie in de bodemlucht in de tijd;
- grondwaterstand versus tijd.

### 4.7 Alternatief voor proeftest

Het uitvoeren van een proeftest is het ideaal, zowel voor de sanering op lange termijn als vanuit economisch perspectief. In sommige situaties zijn deze opties niet haalbaar en zijn er andere opties beschikbaar. Hoewel ze misschien niet zo kosteneffectief zijn als het uitvoeren van een paar voorafgaande proeftesten vóór de installatie, zijn er aanvaardbare resultaten mee bereikt.

Het eerste alternatief voor het uitvoeren van een proeftest is het simpelweg installeren van een tijdelijk saneringssysteem op de locatie en het saneringsproces meteen te starten. De huidige technologische vooruitgang heeft kleinere, veelzijdigere bodemlucht-extractie-systemen voortgebracht, en vele worden op huurbasis aangeboden. Deze kleinere, mobiele systemen maken het mogelijk indien nodig wijzigingen aan te brengen.

Het tweede alternatief voor het uitvoeren van een proeftest is het gebruik van algemene referentie-informatie over de locatie om de kenmerken van de locatie in te schatten. Indien de lithologie en de basisomvang van de verontreiniging bekend zijn, kan met behulp van korrelgrootte-analyse de doorlaatbaarheid van de bodem, en uiteindelijk de luchtstroming, worden geraamd. Deze "achterkant van het sigarendoosje"-methode is goed voor gebieden met relatief kleine hoeveelheden verontreiniging. De nadelen van deze methode zijn dat de waargenomen fysische en chemische parameters soms niet voor de hele locatie dezelfde zijn, en dat het bijzonder moeilijk is gelaagde geologische omstandigheden te beoordelen. Bovendien zouden, indien de sanering luchtmissies met zich meebrengt, de schattingen van de luchtconcentraties niet beschikbaar zijn vóór de uitvoering ervan.

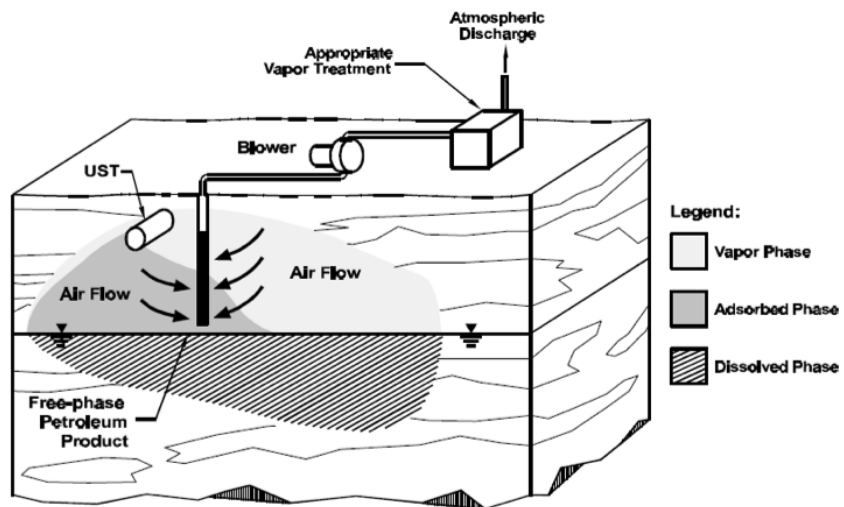

Figuur 4.9- Regeling met één aanjager

Deze stappen kunnen al dan niet opeenvolgend worden uitgevoerd.

## 5 PRESTATIEBEWAKING

De monitoring wordt uitgevoerd tijdens de operationele fase om de voortgang van de sanering te evalueren, en vóór de beëindiging van het systeem om na te gaan of de saneringsdoelstellingen zijn gehaald.

Het monitoringplan moet voorzien in frequentere monsterneming bij het opstarten van het systeem en voor de bevestiging van de sanering. Tijdens de operationele fase van de monitoring, wanneer het systeem eenmaal is geoptimaliseerd, kunnen de frequentie en de intensiteit van de monsterneming worden verlaagd [USACE 2002].

### 5.1 Toezicht op de operationele fase

Hieronder volgt een korte beschrijving van de belangrijkste parameters die bij de routinecontrole in aanmerking moeten worden genomen.

#### 5.1.1 Chemische parameters

- Chemische monitoring van de bodemlucht is noodzakelijk om de effectiviteit van het saneringsproces te evalueren. Bodemlucht moet worden verzameld uit afzonderlijke onttrekkingsputten en bodemluchtsondes. Tijdens de operationele fase worden veldinstrumenten, zoals vlam- of foto-ionisatiedetectoren, vaak gebruikt voor frequente of continue metingen van de totale hoeveelheid VOS. Metingen met bovengenoemde instrumenten moeten worden beschouwd als screeningsmethoden, vanwege hun niet-specifieke respons en de volgende andere beperkingen [EPA 2001]:
  - De hoge ionisatiepotentiaal van veel voorkomende VOS leidt tot niet-detectie met een conventionele PID-lamp.
  - Gasmatrix-effecten zoals vochtigheid, kooldioxide en alkaan (vooral methaan) kunnen de PID-respons verminderen. Wanneer de relatieve vochtigheid echter zeer hoog is, dicht bij 100%, kan waterdamp op de sensor condenseren, wat een vals-positieve reactie veroorzaakt. Dit signaal wordt veroorzaakt door een stroomlekkage tussen de elektroden in de sensor [RAE System 2013].
  - Het hoge halogeengehalte van veel voorkomende VOS zal leiden tot een onderschatting of niet-detectie van VOS met behulp van een FID.
- VOS- en debietmetingen in het influent van het bodemlucht-extractie-systeem, en mogelijk in afzonderlijke onttrekkingsputten, moeten worden gebruikt om de massaverwijderings-percentages van verontreinigende stoffen uit de onverzadigde bodem te berekenen.
- De concentraties van verontreinigende stoffen worden gewoonlijk gemeten bij de in- en uitstroom van de rookgaszuivering (voor en na de koolstofbussen) om de doeltreffendheid van het luchtemissie-beheersingssysteem te beoordelen.
- Chemische monitoring van het grondwater: saneringen in de onverzadigde zone mogen niet los van de toestand van het grondwater worden uitgevoerd. Onverzadigde grond kan namelijk opnieuw worden verontreinigd door capillaire werking en grondwaterspiegel-fluctuaties. Ook de verontreinigingsconcentraties in het grondwater moeten worden gemonitord om de massaoverdracht van de waterfase naar de bodemlucht te evalueren.

## 5.1.2 Fysieke parameters

- Bodem- en bodemlucht-temperatuurmeting

Gegevens over de bodemlucht-temperatuur kunnen helpen bij de evaluatie van de doeltreffendheid van het bodemlucht-beheersingssysteem en bij de normalisatie van de debietgegevens, zoals hieronder besproken. Bodemtemperaturen kunnen een indicator zijn van biologische afbraakprocessen in de onverzadigde zone.

- Relatieve vochtigheid

Het vochtgehalte vermindert het volume van de poriënruimte die bijdraagt tot de stroming van bodemlucht. Een hoog vochtgehalte kan de luchtdoorlatendheid en de luchtstroming door de onverzadigde zone verminderen; om dezelfde reden kan het de resultaten van de bodemluchtcontrole beïnvloeden. Voorts kan de relatieve vochtigheid van het onttrokken gas worden verlaagd om de blower te beschermen en de efficiëntie van het bodemlucht-emissiecontrolesysteem te bevorderen (de adsorptiecapaciteit van actieve kool neemt aanzienlijk af wanneer de relatieve vochtigheid hoger is dan 50%). De relatieve vochtigheid van de bodemlucht-stroom kan meestal worden verlaagd met behulp van een luchtverwarmingssysteem [USACE 2002]. Vaak levert de geïnstalleerde blower de benodigde warmte. De verwarming van de bodemlucht-stroom wordt beperkt door de hoogst toelaatbare temperatuur bij gebruik van actieve kool.

- **Waterniveaus:** moeten worden gecontroleerd in het gebied van de winningsput(ten) om de mate van opstuwning te bepalen die optreedt als gevolg van het toegepaste vacuüm. Er moet bijzondere aandacht worden besteed aan grondwaterspiegel-fluctuaties omdat deze de massaoverdracht van verontreinigende stoffen tussen vaste, vloeibare en gasfase kunnen versterken. Bovendien kan kwel tot een overmaat aan vocht in de behandlungszone leiden, waardoor de sorptiecapaciteit van actieve kool afneemt. Dit probleem kan worden beperkt door de vochtafscheiding te verbeteren en/of actief grondwater te pompen om de opstuwning in situ tegen te gaan [USACE 2002].
- **Meting van het debiet:** gegevens over het debiet van elke put, in combinatie met het overeenkomstige toegepaste vacuüm, kunnen informatie opleveren over de luchtdoorlatendheid van de onverzadigde zone. Aanbevolen wordt de debieten te normaliseren naar een standaardtemperatuur en druk, zodat de bij verschillende onderzoeken verzamelde gegevens gemakkelijk kunnen worden vergeleken.
- **Vacuüm-/drukmeting:** de meting van waargenomen vacuüms op verschillende plaatsen en diepten geeft een indicatie van de luchtstromingstrajecten. Drukgradiënten die uit de vacuümmetingen worden afgeleid, moeten worden gekoppeld aan ramingen van de horizontale en verticale luchtgeleiding om de verplaatsingstijd of de snelheid te beoordelen [Truex 2013].

## 5.1.3 Meteorologisch

Meteorologische gegevens (bijvoorbeeld neerslag, barometerdruk, omgevingstemperatuur) moeten worden geregistreerd en in aanmerking worden genomen voor een correcte evaluatie van de monitoringresultaten.

- **Neerslag:** regenval, die het transport van VOS in de onverzadigde bodem beperkt, kan een aanzienlijk effect hebben op de prestaties van de bodemlucht-extractie en op de resultaten van de bodemluchtmonitoring. Daarom mogen geen bodemluchtmonsters worden genomen na significante regenval (1,5 cm of meer neerslag gedurende een periode van 24 uur). De wachttijd moet worden gebaseerd op bodemdrainagecurves [CalEPA 2015].

- Barometerdruk: de schommelingen van de atmosferische druk veroorzaken gasbewegingen tussen de atmosfeer en de ondergrond. Gasbeweging in de onverzadigde zone, veroorzaakt door natuurlijke schommelingen in de atmosferische druk, wordt barometrische pomp genoemd. Wanneer de atmosferische druk daalt, worden gassen uit de ondergrond omhoog gezogen naar de atmosfeer. Omgekeerd, wanneer de atmosferische druk stijgt, wordt verse lucht naar beneden in de ondergrond geduwd [Kuang 2013]. Het effect van barometrische drukschommelingen op het transport van atmosferische gassen kan duidelijker zijn tijdens stilleggingsperiodes.

## 5.2 Bevestiging van behalen saneringsdoelstelling en het afsluiten van het systeem

De doelstelling van het saneringsproces is in het algemeen het bereiken van vooraf bepaalde kwaliteitsnormen voor verschillende milieumatrices. Het uiteindelijke beëindigings-criterium voor een VVE-systeem is meestal gebaseerd op het bereiken van een wettelijke en/of risico-gebaseerde bodemconcentratienorm. Bodembemonstering is echter zowel kostbaar als potentieel verstorend; bovendien vereist het nauwkeurig traceren van restverontreiniging het analyseren van een groot aantal monsters, omdat de bodem, als ongemengd medium, heterogeen is [USACE 2002]. Daarom worden, alvorens een grootschalig bodemonderzoek wordt gestart, andere parameters (bewijsvoeringslijnen) overwogen/gemonitord om de voortgang van de sanering te beoordelen en om te evalueren of de saneringsdoelstellingen waarschijnlijk zijn gehaald.

### 5.2.1 Mogelijke aanknopingspunten voor bevestiging van de opruiming

- Bodembemonstering: duur en verstorend. Bij het gebruik van bodembemonstering voor de bevestiging van de sanering en de sluiting van het systeem moet zorgvuldig rekening worden gehouden met de heterogene spreiding van de bodemconcentraties op een locatie en de onzekerheden die verbonden zijn aan de bemonstering van de bodem op VOC's [USACE 2002].
- Trend in de geëxtraheerde bodemlucht-concentratie: de VOS-concentratie in extractieputten kan een maat geven voor de verwijderde massa verontreinigende stoffen en een indicatie geven van de voortgang van de sanering. Gewoonlijk vertoont de gegevenstrend na enkele maanden gebruik een snelle daling, waarna de concentraties asymptotische niveaus naderen (zie Fig. 5.1 en Fig. 5.2). In veel gevallen wordt het bereiken van een asymptotische toestand als doorslaggevend beschouwd voor het vaststellen van technologische prestatiegrenzen en het sluiten van ontluchtingssystemen. De waarneming van lage asymptotische bodemlucht-concentraties in het uitstromende gas is echter een noodzakelijke, maar niet voldoende voorwaarde om vooruitgang bij de massaverwijdering uit verontreinigde bodems aan te tonen. Een asymptoot in het effluent kan namelijk verband houden met het ontwerp van de ontluchting (bijvoorbeeld de afstand tussen de putten) of met de bedrijfsomstandigheden (bijvoorbeeld het debiet), los van of in aanvulling op het bodemlucht-transport met een beperkte snelheid [EPA 2001].



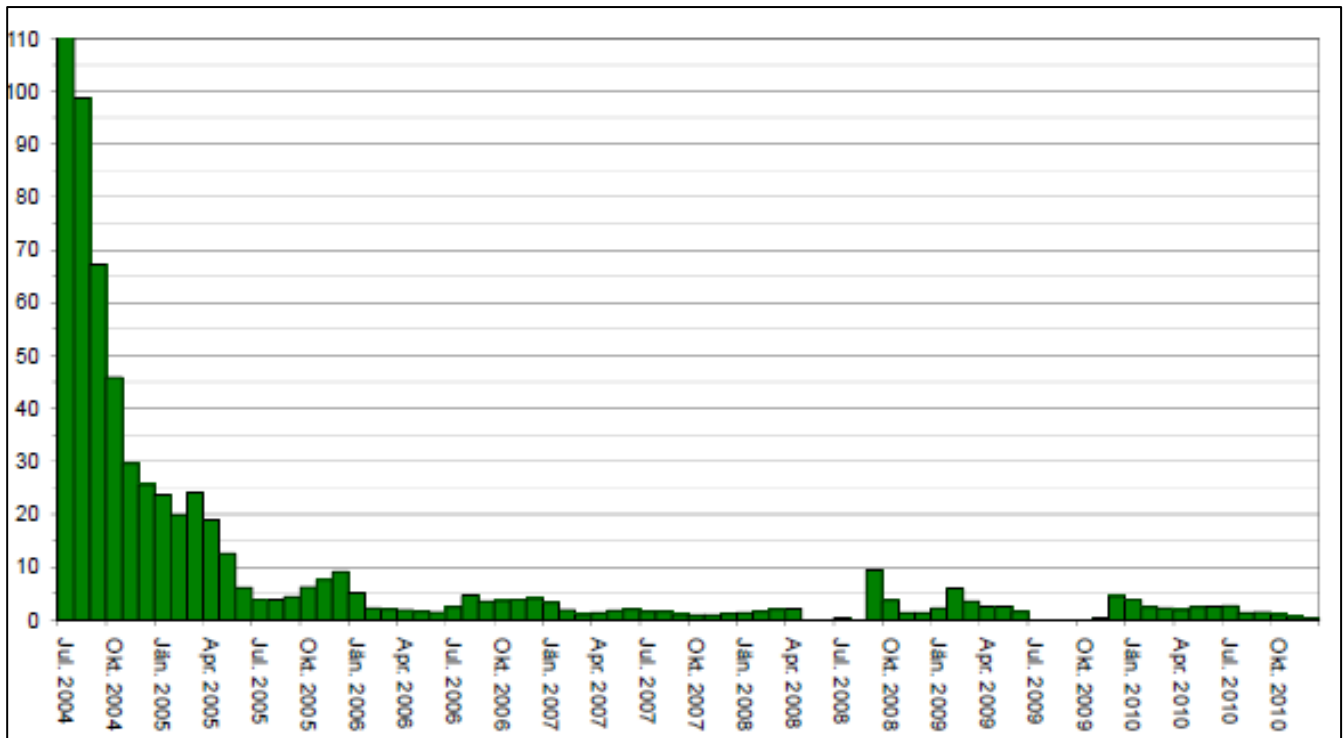

Figuur 5.1 - Tendensen in de verwijdering van de massa verontreinigende stoffen (bodemplucht-extractie): kg PCE/dag

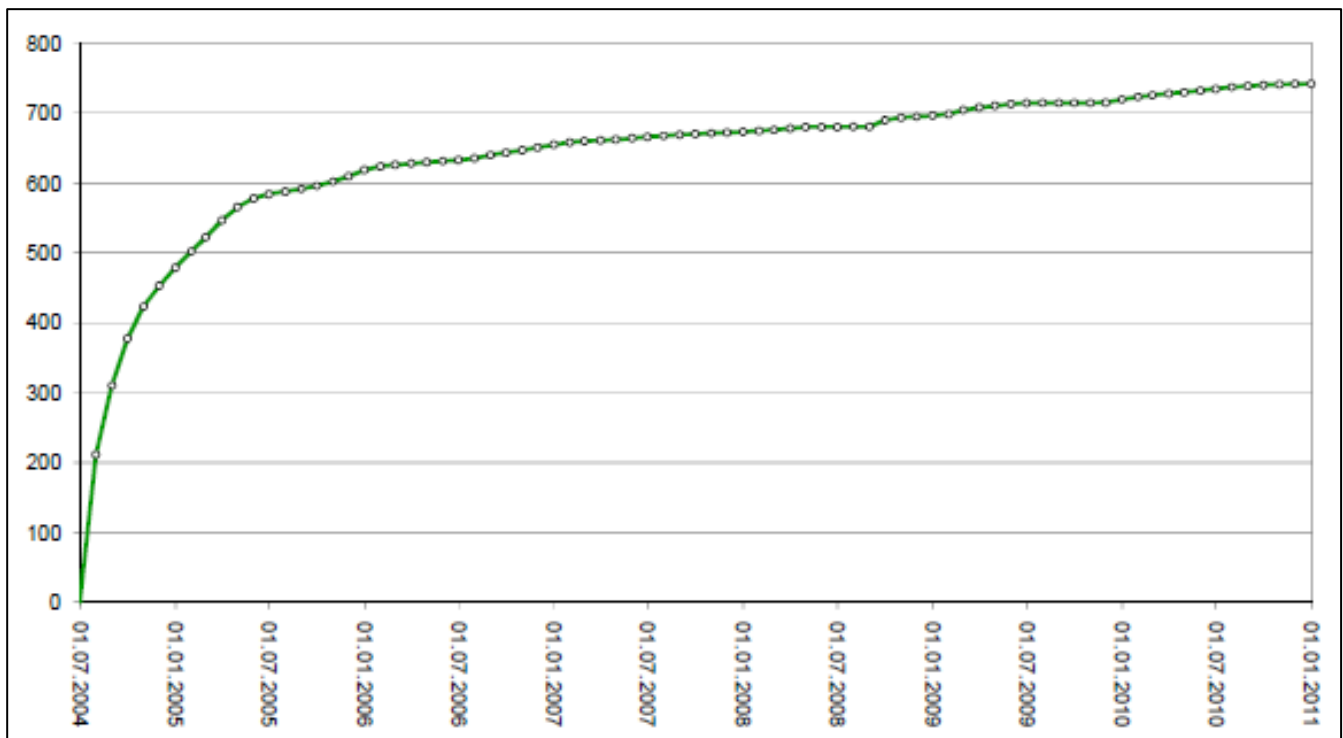

Figuur 5.2 - Tendensen in de verwijdering van de massa verontreinigende stoffen (bodemplucht-extractie): kg PCE (totaal in de tijd)

- Bodemlucht-extractie is doeltreffender in bodemgedeelten nabij of tussen de putten die grondig worden doorgespoeld, zodat de VOS-concentraties zeer lage asymptotische niveaus kunnen bereiken terwijl een aanzienlijke hoeveelheid verontreinigende massa in de bodem achterblijft, vooral in de buurt van stagnatiezones.
- Het bereiken van asymptotische concentratieniveaus in de geëxtraheerde bodemlucht kan bovendien impliceren dat er een snelheidsbeperkte massaoverdracht optreedt tijdens de ontluchting van de bodem. Als de ontluchtingssnelheid groter is dan de snelheid van de diffusieve massaoverdracht tussen de fasen (vast, vloeibaar en gas) in de onverzadigde zone, kunnen de concentraties verontreinigende stoffen in de geëxtraheerde bodemlucht afnemen zonder dat alle verontreinigende massa uit de bodem en het poriewater is verwijderd [USACE 2002].
- Bodemluchtmonitoring: bodemluchtmonsters zijn minder duur om te verzamelen en, aangezien lucht een gemengd medium is, leveren zij over het algemeen meer geïntegreerde (d.w.z. van een groter gebied) gegevens op. VOS-monitoring in bodemluchtsondes is dan ook waarschijnlijk een effectievere en efficiëntere methode om de voortgang van de sanering te beoordelen dan de eerder onder a) en b) beschreven methoden. Bodemluchtbemonstering dient echter plaats te vinden volgens een standaardprocedure waarbij rekening wordt gehouden met de invloed van veldomstandigheden (bv. lithologie, vochtigheid) en bemonsteringsparameters (bv. bemonsteringsdebiet, bemonsteringsvolume) op de monitoringresultaten. Bodemluchtsondes moeten ook worden geïnstalleerd in gebieden ver van de winningsputten, die moeilijker te saneren zijn, om de resterende verontreiniging op te sporen.
- Terugslag: tijdens de operationele fase wordt doorgaans een daling van de VOS-concentraties in de bodemlucht waargenomen als gevolg van een snelheidsbeperkte massaoverdracht (uitstervingseffect) en verdunning met omgevingslucht. Wanneer het bodemlucht-extractie-systeem wordt uitgeschakeld, kunnen de VOS-concentraties dus stijgen als gevolg van diffusie tussen verschillende fasen en zones van de onverzadigde bodem. Dit fenomeen, meestal omschreven als rebound, kan worden beschouwd als een betrouwbare indicator van de effectiviteit van de behandeling. Een minimale terugslag of het ontbreken van terugslag, noch in stagnerende zones, na een bepaalde periode van stilstand van het systeem geeft aan dat de beschikbare massa waarschijnlijk is verwijderd. De tijd die nodig is om een evenwicht te bereiken is afhankelijk van de verontreiniging en het bodemtype. Zandige bodems zullen in het algemeen binnen enkele weken een evenwicht bereiken, terwijl voor sterk gelaagde bodems enkele maanden nodig kunnen zijn. Jaarlijkse evenwichtstesten (rebound) worden aanbevolen [AFCEE 2001].

### 5.2.2 Voorgestelde procedure voor beëindiging van de bemonstering

De uiteindelijke beëindigingscriteria voor een bodemlucht-extractie-systeem zijn meestal gebaseerd op het bereiken van een vastgestelde bodemconcentratienorm. Echter, zoals eerder besproken, aangezien bodembemonstering zowel kostbaar als potentieel verstorend is, worden alvorens een grootschalig bodemonderzoek te starten, andere parameters (bewijslijnen) gemonitord om te beoordelen of de saneringsdoelstellingen waarschijnlijk zijn gehaald. Daarom wordt de volgende procedure voor de bevestiging van de sanering voorgesteld, die gebaseerd is op een verificatieproces in drie stappen.

- het bereiken van een beoogde bodemlucht-concentratie tijdens de operationele fase;
- het bereiken van een beoogde bodemlucht-concentratie na een tijdelijke beëindiging van het systeem;
- vergelijking van de resultaten van de bodembemonstering met de zuiveringscriteria.

## 6 CONCLUSIES

Bodemlucht-extractie is een in situ-technologie die geschikt is om de concentratie van vluchtige verontreinigende stoffen in de onverzadigde zone te verminderen.

Bodemlucht-extractie is over het algemeen effectief gebleken voor vluchtige organische stoffen (VOS) en kan de sanering van semi-vluchtige organische stoffen (SVOS) ondersteunen. In specifieke projecten wordt bodemlucht-extractie bij de sanering van locaties die verontreinigd zijn met gechloreerde oplosmiddelen, zoals chloorethyleen (PCE en TCE), of vluchtige aardolieproducten, zoals benzine, vaak toegepast in combinatie met andere technologieën.

### 6.1 Doeltreffendheid, voordelen en nadelen

De belangrijkste factoren die de doeltreffendheid van bodemlucht-extractie bepalen, zijn:

- luchtdoorlatendheid in de bodem (dit beïnvloedt de hoeveelheid lucht en stoom die zich door de bodem kan verplaatsen);
- bodemstructuur en stratificatie (belangrijk omdat zij van invloed kunnen zijn op de wijze waarop bodemlucht tijdens de extractie in de bodem stroomt);
- bodemvocht (kan de gasstroom door de poriën beperken);
- diepte van de grondwaterspiegel.

De belangrijkste voordelen zijn:

- Aangetoonde doeltreffendheid, gemakkelijk verkrijgbaar gereedschap, eenvoudige installatie.
- Weinig verstoring van de activiteiten op het terrein: het ontwerp van een bodemlucht-extractie-systeem is vrij flexibel, zodat het kan worden aangepast aan alle omstandigheden op het terrein en aan de gebouwde omgeving, en ook de constructie is weinig ingrijpend en kan op vergelijkbare wijze worden aangepast.
- Korte behandelingstijden (6 maanden - 2 jaar in optimale omstandigheden): de behandelingstijden hangen grotendeels af van de omstandigheden ter plaatse, maar zijn in vergelijking met andere technologieën relatief kort. Zij kunnen meestal enkele maanden tot enkele jaren duren, met een effectieve massaverwijdering tot 90% voor zeer vluchtige verbindingen en ongeveer 30-40% voor semi-vluchtige verbindingen.
- Gemakkelijk te bedienen, relatief goedkoop en kosteneffectief in vergelijking met andere technologieën die geschikt zijn voor de sanering van vluchtige verontreinigingen (concurrerende kosten: ongeveer 15-60 euro/ton verontreinigde grond);
- Het is toepasbaar op locaties waar puur product aanwezig is en kan worden gecombineerd met andere technologieën. Het vacuüm dat in de bodemlagen wordt geïnduceerd, beheerst de migratie van bodemlucht in de ondergrond en beschermt gebouwen en ondergrondse infrastructuren tegen het binnendringen van ontvlambare of toxische vluchtige verontreinigende stoffen.

De belangrijkste beperkingen zijn:

- Moeilijk om een concentratievermindering van meer dan 90% te bereiken;
- Weinig doeltreffend op plaatsen met geringe doorlatendheid of heterogene gelaagde bodems.

## 6.2 Operationele controle voor bodemlucht-extractie-toepassing

Eén van de belangrijkste voorafgaande controles die moeten worden uitgevoerd om de toepasbaarheid van de technologie te evalueren, is het bepalen van de geometrische, lithologische en hydrogeologische kenmerken van het onverzadigde medium en het evalueren van een eventuele stijging of daling van de grondwaterspiegel. Bij het overwegen van een 3-D afbakening van de te behandelen onverzadigde zone is het ten slotte nuttig de totale massa van de betrokken verontreiniging(en) vóór de sanering te schatten om een vergelijking mogelijk te maken met de massaverwijderings-snelheden, de veranderingen in de efficiëntie in de tijd en de totale massaverwijdering bij het beëindigen van de toepassing.

Van de parameters die tijdens de aanleg moeten worden gecontroleerd, zijn de belangrijkste: de invloedstraal (R) en de behandelingsstraal (ROT). Andere te controleren parameters die de werking beïnvloeden zijn: schommelingen in het grondwaterpeil, de luchtinlaatsystemen, de efficiëntie in de tijd van het systeem voor de behandeling van de onttrokken gassen, voordat zij in de atmosfeer terechtkomen. Het systeem moet tijdens de werking onder controle worden gehouden, ook om het juiste tijdstip voor de beëindiging van de behandeling te bepalen.

Aan het einde van de sanering via bodemlucht-extractie zijn enkele controles nodig om de eventuele beëindiging van de sanering te evalueren. Daartoe moet de exploitant een reeks gegevens evalueren en bij het bevoegd gezag een verslag indienen over de milieutoestand die na de uitgevoerde onderzoeken is vastgesteld, en vervolgens bij het bevoegd gezag alle elementen indienen die nuttig zijn om te controleren of de sanering haar doelstellingen heeft bereikt.

## REFERENTIES

Documenten worden in alfabetische volgorde geciteerd als: [Auteur(s), Jaar, Titel, #].

- AFCEE, 2001. United States Air Force Environmental Restoration Program: Richtlijnen voor de optimalisatie van de extractie van bodemluchten. Air Force Center for Environmental Excellence, Brooks Air Force Base, Texas. Laatst bekeken op 17 juli 2012, op <http://www.dtic.mil/docs/citations/ADA392205>;
- Luchtspoeling: Technology Transfer and Multi-Site Evaluation ESTCP Project ER-9808, vrij te downloaden op <https://www.serdp-estcp.org/content/download/3734/59418/file/ER-9808%20Design%20Paradigm.pdf>
- Analysis of Selected Enhancements for Soil Vapor Extraction, september 1997, EPA-542-R-97-007, geraadpleegd op <https://clu-in.org/download/remed/sveenhmt.pdf>
- Baker, R.S., en Wiseman, J.T. 1992. Importance of vadose zone monitoring during soil vapor extraction pilot studies. Proceedings: International Symposium on In Situ Treatment of Contaminated Soil and Water. Cincinnati, OH. 3-6 februari 1992. Air and Waste Management Association, blz. 26-41.
- Ball, R., en Wolf, S. 1990. Design considerations for soil cleanup by soil vapor extraction. Vooruitgang op milieugebied. 9(3):187-90
- Breckenridge, R.P., Williams, J.R., and Keck, J.F. 1991. Karakterisering van de bodem voor de beoordeling van locaties voor gevaarlijk afval. Ground-Water Issue, EPA/540/4-91/003, Office of Research and Development, Office of Solid Waste and Emergency Response.
- CalEPA, 2015: California Environmental Protection Agency, Advisory - Active Soil Gas Investigations, Department of Toxic Substances Control.
- Davies, S. H. 1989. The influence of soil characteristics on the sorption of organic vapors. Workshop over bodemvacuüm extractie. R.S. Kerr Environmental Research Laboratory, Ada, OK. 27-28 april 1989.
- DiGiulio, D.C., en R. Varahan. 2001a. Limitations of ROI testing for venting design: description of an alternative approach based on attainment of a critical pore-gas velocity in contaminated media. Grondwatermonitoring en sanering 21(1): 97-114.
- Engineering Issue: Soil Vapor Extraction (SVE)-technologie, februari 2018, EPA/600/R-18/053, geraadpleegd op [https://cfpub.epa.gov/si/si\\_public\\_file\\_download.cfm?p\\_download\\_id=538425&Lab=NRML](https://cfpub.epa.gov/si/si_public_file_download.cfm?p_download_id=538425&Lab=NRML).
- Farallon consulting, Final capital industries plant 4soil vapor extraction pilot study work plan vrij te downloaden op <https://www.farallonconsulting.com/wp-content/uploads/2020/09/2019-Final-SVE-Pilot-Study-WP.pdf>
- Freeze, R.A., en Cherry, J.A. 1979. Grondwater. Prentice Hall, Englewood Cliffs, NJ. 604 pp.
- Matrix voor het screenen van FRTR-technologieën: Thermische behandeling, maart 2020, geraadpleegd op <https://frtr.gov/matrix2/section4/4-9.html>.
- Interim Definitief. Richtlijn 9234.2-25, september 1993. OSWER. Washington, DC. 26 pp.
- Johnson, Jeffrey, DeWitt, Christopher B., Wolfe, Bryan, en Mark Garman. 1999. Moisture and Ammonia-Enhanced Bioventing in Arid Environments, abstract, in "Proceedings of the Fifth International Symposium on In-Situ and On-Site Bioremediation, San Diego, CA, April 19-22, 1999".
- Jury, W.A., Winer, A.M., Spencer, W.F., and Focht, D.D. 1987. Transport and transformations of organic chemicals in the soil-air-water ecosystem. Reviews of Environmental Contamination and Toxicology. 99:120-64.
- Kuang et al., 2013 Review on airflow in unsaturated zones induced by natural forcings. Water Resour. Res., 49 (2013), pp. 6137-6165
- Minnesota Pollution Control Agency Voluntary Investigation and Cleanup Design Criteria and Reporting Requirements Guidance Document #17 (Vapor Extraction, Air Sparging), vrij te downloaden op <https://www.pca.state.mn.us/sites/default/files/vic-gd17.pdf>
- PNNL. Richtsnoeren voor exploitatie, overgang en sluiting van het Bodemlucht-extractie-systeem (2013)
- RAE System, 2013 Het PID-handboek. Theorie en toepassingen van Direct-Reading Photoionization

Detectors, ISBN: 0-9768162-1-0

- Soares, A.A., Pinho, M.T., Albergaria, J.T. et al. Sequentiële toepassing van bodemluchtexttractie en bioremediëringsprocessen voor de sanering van met ethylbenzeen verontreinigde bodems. *Water Air Soil Pollut* 223, 2601-2609 (2012).
- Soil Vapor Extraction (SVE) treatment technology resource guide, september 1994, EPA/542-B-94-007, vrij te downloaden op [https://www.epa.gov/sites/production/files/2015-08/documents/sve\\_tt\\_res\\_guide.pdf](https://www.epa.gov/sites/production/files/2015-08/documents/sve_tt_res_guide.pdf)
- Florida, richtsnoeren voor proefnemingen met dampafzuiging uit de bodem <https://floridadep.gov/sites/default/files/BPSS12B-SVEGuidance.pdf>
- Suthersan, S. S. (1999). Bodemluchtexttractie. In *Saneringstechniek: Ontwerpconcepten* (pp. 27-88). Boca Raton: Lewis Publisher Inc.
- De Bodemlucht-extractie-proef, geraadpleegd op 16/03/2021 op <https://www.enviroequipment.com/blog/soil-vapor-extraction-sve-pilot-test>
- Truex, M. J., D. J. Becker, M. A. Simon, M. Oostrom, A. K. Rice, EN C. D. Johnson. *Soil Vapor Extraction System Optimization, Transition, and Closure Guidance*, PNNL-21843. U.S. Department of Energy, Washington, DC, 2013.
- USACE. 2002. *Techniek en ontwerp: Bodemlucht Extractie en Bioventing*. EM 1110-1-4001, U.S. Army Corps of Engineers, Washington, D.C. Laatst bekeken op 17 juli 2012, op [http://publications.usace.army.mil/publications/eng-manuals/EM\\_1110-1-4001\\_sec/toc.htm](http://publications.usace.army.mil/publications/eng-manuals/EM_1110-1-4001_sec/toc.htm)
- USAF. Richtsnoeren voor de optimalisatie van de afzuiging van bodemdampen (2001)
- US EPA. 2001. *Development of Recommendations and Methods to Support Assessment of Soil Venting Performance and Closure*. EPA/600/R-01/070, U.S. Environmental Protection Agency, Washington, D.C.
- USEPA. 1991h. *Beschrijving en bemonstering van verontreinigde bodems, A Field Pocket Guide*. EPA 625/12-91/002, Centrum voor informatie over milieuonderzoek, Cincinnati, OH.
- USEPA. 1989c. *Laboratory Investigation of Residual Liquid Organics from Spills, Leaks, and the Disposal of Hazardous Wastes in Groundwater* (Laboratoriumonderzoek naar restanten van vloeibare organische stoffen van lozingen, lekkages en de verwijdering van gevaarlijke afvalstoffen in grondwater). EPA/600/6-90/004. New Mexico Institute of Mining and Technology, Socorro, NM.
- USEPA. 1993g. Richtsnoeren voor het evalueren van de technische onuitvoerbaarheid van grondwatersanering.



European Union Network for the Implementation  
and Enforcement of Environmental Law

# Annex 1

---

## Soil Vapour Extraction – Case studies

IMPEL Project no. 2020/09



## 1. Contact details - CASE STUDY: SVE n.1

<b>1.1 Name and Surname</b>	Aline Jordens, Mathieu Petitjean, Hatem Saadaoui, Jan Haemers
<b>1.2 Country/Jurisdiction</b>	Belgium
<b>1.3 Organisation</b>	Haemers Technologies
<b>1.4 Position</b>	Innovation Engineer
<b>1.5 Duties</b>	R&D
<b>1.6 Email address</b>	<a href="mailto:innovation@haemers-tech.com">innovation@haemers-tech.com</a>
<b>1.7 Phone number</b>	+32 2 786 39 43





## 2. Site background

### 2.1 History of the site

The site is located in the military airbase of Biên Hòa, Dong Nai, Vietnam. During the US-Vietnam War (1955-1975), millions of litres of herbicides were dropped over Vietnam: The Rainbow agents. Those Rainbow Agents were sprayed throughout the Operation Ranch Hand to clear thick jungle, by defoliating crops and forest. Bien Hoa Airbase was a joint operating base for the South Vietnam Air Force and the United States Air Force. According to the U.S. Department of Defense, 98 000 barrels of Agent Orange, 45 000 barrels of Agent White and 16 000 barrels of Agent Blue were stored at Bien Hoa Airbase [1].

As a consequence, the Biên Hòa airbase is currently the largest dioxin hotspot in Vietnam [2].

Nowadays, it is estimated that between 408,500 and 495,300 m<sup>3</sup> of dioxin-contaminated soil and sediment are present in the site [3]. This is almost 4 times the volume of the last airbase that underwent treatment (Danang).

More than four decades after the Vietnam War ended (in 1975), the stability and bioaccumulation of dioxins still affect the inhabitants. Measures had to be taken to improve living conditions for residents, starting with the remediation of dioxin contaminated soil. In 2018, at the request of the Government of Vietnam (GVN), the U.S. Government agreed to cooperate on dioxin remediation at Bien Hoa Airbase Area. Haemers Technologies was invited to perform a pilot remediation in the process of the technology selection for the full-scale project.

[1] DOD. 2007. Presentation made at the Second Agent Orange and Dioxin Remediation Workshop, Hanoi, Vietnam, June 18-19, 2007. Co-sponsored by U.S. Department of Defense and Vietnam Ministry of National Defense.

[2]: USAID, FACT SHEET: DIOXIN REMEDIATION AT BIEN HOA AIRBASE AREA, consulted 16/12/2020, <https://www.usaid.gov/vietnam/documents/fact-sheet-dioxin-remediation-bien-hoa-airbase-area>

[3] USAID. 2016. Environmental Assessment of dioxin contamination at Bien Hoa Airbase





## 2.3 Contaminants of concern

Agent Orange was proven to cause severe health issues, including birth defects, neurological problems and cancers. Agent Orange is a mixture of 2,4-dichlorophenoxyacetic acid and 2,4,5-trichlorophenoxyacetic. Traces of dioxins were also found in some Agents. Indeed, dioxin 2,3,7,8-Tetrachlorodibenzo-p-dioxin (2,3,7,8-TCDD) can be formed by condensation of 2,4,5-trichlorophenol during 2,4,5-trichlorophenoxyacetic synthesis.

Hereafter is shown the breakdown of a sample taken from the site (Contaminated sample column). The “treated sample” column refers to the sample after a lab test. The increase in secondary contaminants after treatment is most likely due to the sample heterogeneity.



	<i>Contaminated sample</i>	<i>Treated sample</i>	<i>Unit</i>
<b>Dry matter</b>	<b>94,9</b>	<b>99,7</b>	<b>% (dry matter mass)</b>
2,3,7,8-Tétra CDD	2800	630	ng/kg DM
1,2,3,7,8-PentaCDD	14	84	ng/kg DM
1,2,3,7,8,9-Hexa CDD	13	27	ng/kg DM
1,2,3,6,7,8-HexaCDD	20	42	ng/kg DM
1,2,3,4,7,8 -Hexa CDD	3,5	7,5	ng/kg DM
1,2,3,4,7,8,9-Hepta CDD	99	46	ng/kg DM
Octa CDD	450	200	ng/kg DM
1,2,3,7,8 Penta CDF	1,7	3,2	ng/kg DM
2,3,4,7,8-Penta CDF	1,2	2,8	ng/kg DM
2,3,7,8-Tétra CDF	75	28	ng/kg DM
1,2,3,7,8,9 - Hexa CDF	<1,0	<1,0	ng/kg DM
2,3,4,6,7,8 - Hexa CDF	2,3	1,9	ng/kg DM
1,2,3,4,7,8 Hexa CDF	1,5	2,0	ng/kg DM
1,2,3,6,7,8 Hexa CDF	<1,0	1,4	ng/kg DM
1,2,3,4,7,8,9 -Hepta CDF	<5,0	<5,0	ng/kg DM
1,2,3,4,6,7,8 -Hepta CDF	9,4	<5,0	ng/kg DM
Octa CDF	<10	<10	ng/kg DM
I-TEQ-PCDD/F-OTAN/CCMS (lower limit)	2820 <sup>4</sup>	685	ng/kg DM
I-TEQ-PCDD/F-OMS 1998 (lower limit)	2830 <sup>4</sup>	727	ng/kg DM
I-TEQ-PCDD/F-OMS 2005 (lower limit)	2830 <sup>4</sup>	726	ng/kg DM
I-TEQ-PCDD/F-OTAN/CCMS (upper limit)	2820 <sup>5</sup>	685	ng/kg DM
I-TEQ-PCDD/F-OMS 1998 (upper limit)	2830 <sup>5</sup>	727	ng/kg DM
I-TEQ-PCDD/F-OMS 2005 (upper limit)	2830 <sup>5</sup>	727	ng/kg DM



## 2.4 Regulatory framework

Haemers Technologies was invited by the Vietnam Government to perform a pilot project in the context of the technology selection for the Bien Hoa airbase remediation led by USAID and GVN.

The soil concentration limits after treatment have been defined as following:

- Industrial use: 1,200 ppt
- Urban area: 300 ppt
- Sediment: 150 ppt

## 3. Pilot-scale application in field

### 3.1 Extraction system

The treatment proposed by Haemers Technologies is a thermopile (ex-site thermal treatment). The thermopile is a small pilot-scale pile of 500 tons (11m x 14m at its base). In a thermopile, the soil is heated by conduction until it reaches the temperature of volatilization of the pollutants (a process known as thermal desorption). The vapours are then extracted to be treated. In the pile are installed 15 heating tubes and 13 exchanger tubes that transfer thermal energy to the soil. The vapours are extracted by 15 perforated tubes that are connected to a 15 kW blower in order to generate a low but constant depression sucking the gasses out. The typical depression generated is in the order of -0.2 mbar.

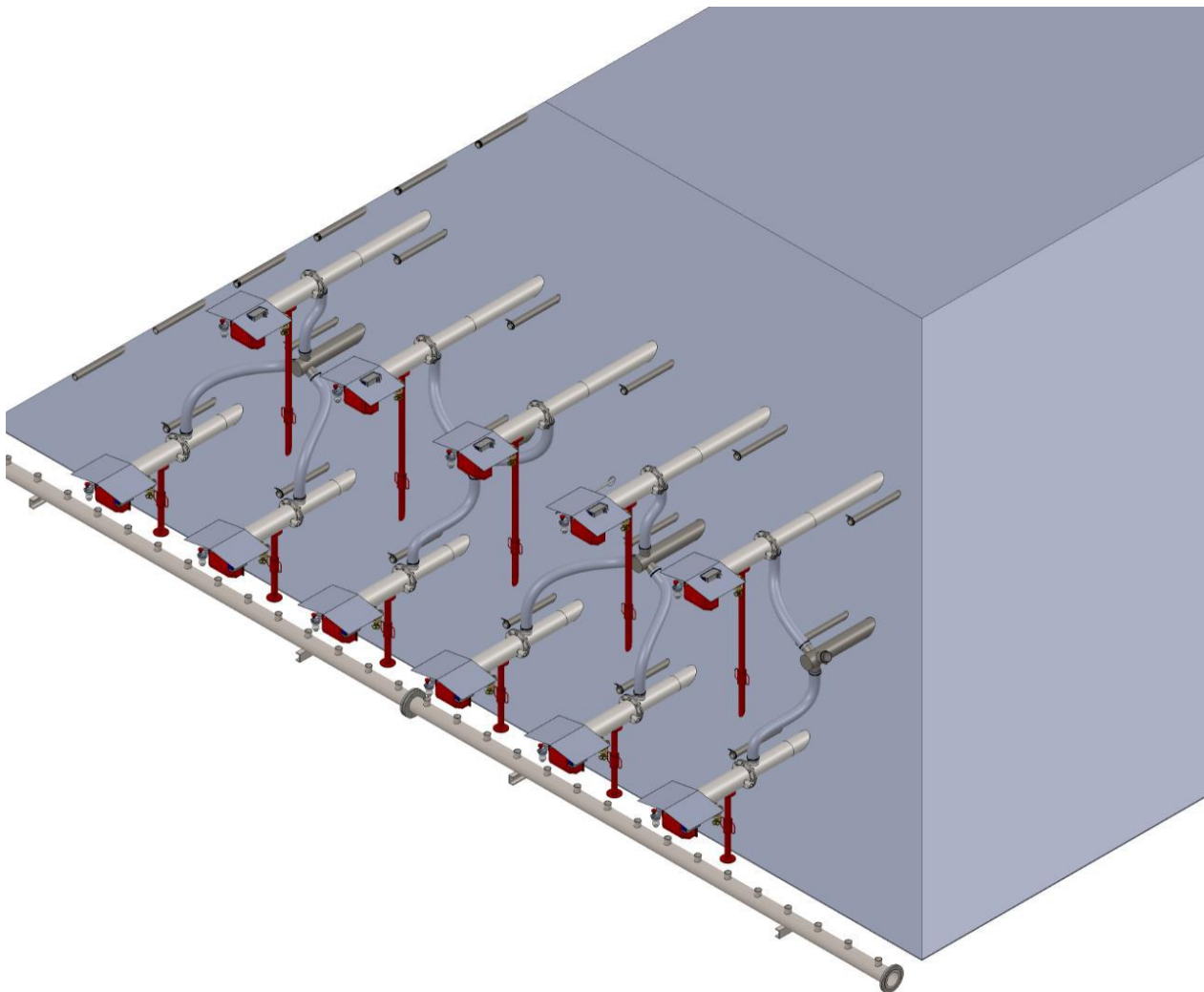



## 3.2 Injection system

In thermal desorption treatment, there is no injection system. The gases are generated when the contaminants and the water are vaporized due to the thermal energy transfer.

## 3.3 Radius of influence

The treatment is effective on the whole pile. Lab tests have shown that if the soil reaches 350°C and that the temperature is maintained for at least 5 days, the target treatment concentrations are met.

The main factor of influence is the interdistance between heating wells in the pile, but they only affect the **heating time**, i.e. the time needed to reach 350°C. The treatment effectiveness is unchanged.

In this case, the soil vapour extraction wells are approx 1.2m apart. This short range is not the actual radius of influence of each well, as this radius varies in the course of the treatment. As temperature increases, soil is drying out, affecting the permeability to vapours. Therefore, the actual radius of influence of each pipe is likely much larger than 1.2m, even if the applied negative pressure is very low (in the order of 0.2mbar). E The high density of soil vapour extraction wells is commanded by the necessity to collect all vapours despite the low negative pressure and avoid fugitive emissions.



### 3.4 Off gas Treatment

The contaminated vapours are sucked from the pile and transit through the Vapor Treatment Unit (VTU). Contrary the approach taken by USAID at Danang which used activated carbon, Haemers Technologies uses a Thermal Oxidizer in order not to leave any waste requiring further treatment.

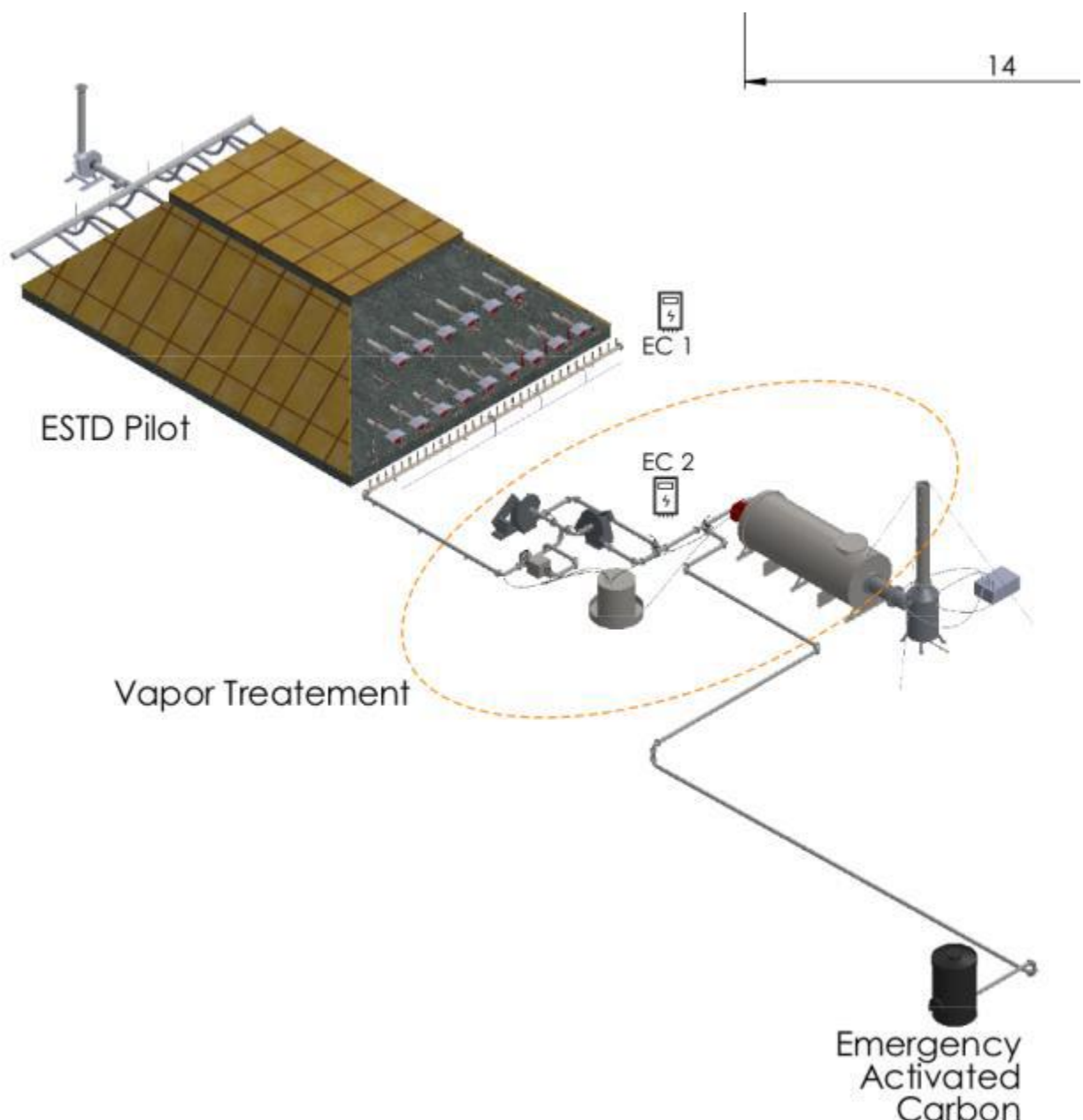



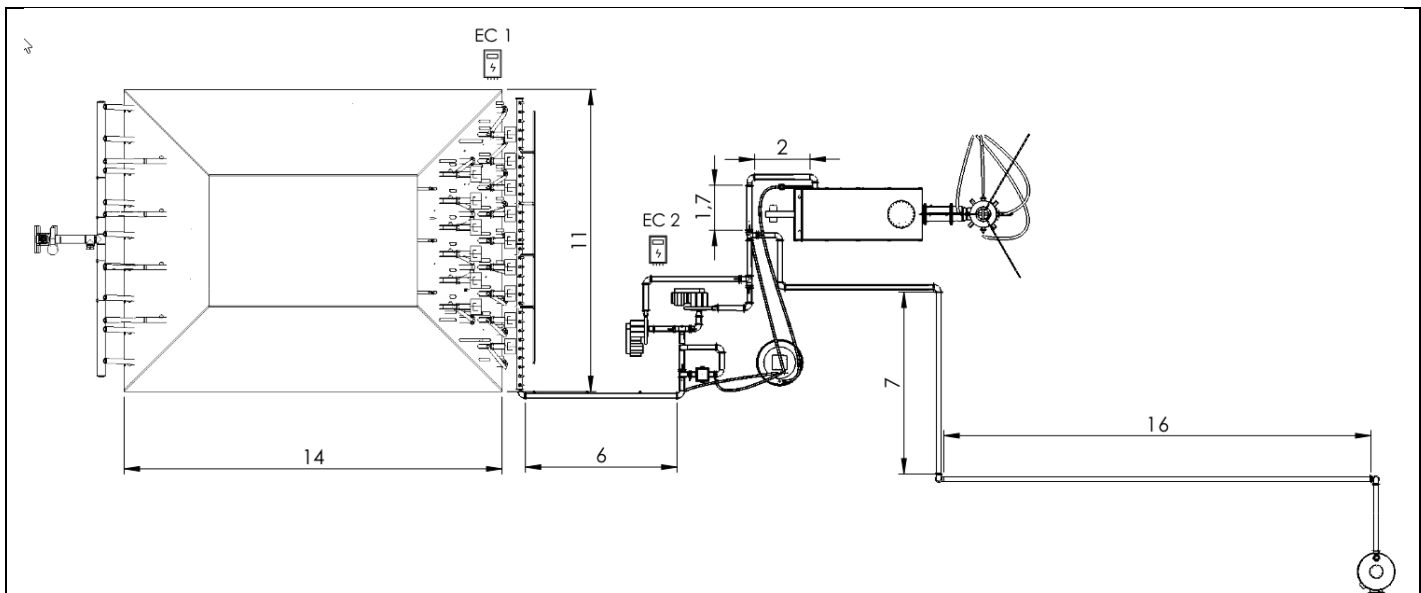

Before entering the Thermal Oxidizer, the vapours may circulate through an Arsenic filter if needed.

The vapours are then directly incinerated in order to destroy all PCDD and PCDF's. Proper oxidation guarantees compliant air emissions. It has to be noted that condensation will certainly happen along the network. To reduce liquid formation, the network is thermally insulated. Nevertheless, the liquid formed can be reinjected in the Thermal Oxidizer. To reach a destruction rate efficiency over 99,99%, the following criteria must be fulfilled in the oxidation chamber [4][5]:

1. Temperature of minimum 1100°C (preferably 1200°C)
2. Oxygen content of min 6% (preferably 10%)
3. Residence time of minimum 1 second (preferably 2 seconds)
4. High Turbulence ( $Re \gg 2500$ ).

It is well known that dioxin compounds reformation can happen in the cooling phase, in a temperature range between 200°C and 500°C. Dioxins can be reformed in the presence of oxygen, chlorine ( $Cl_2$ ) and hydrocarbons [6]. Other parameters such as presence of dust and/or presence of metals, can also promote the dioxins/furans formation. To avoid the reformation process, the vapours are directed towards a cooling quench tower to a temperature below 180°C before being released in the atmosphere.

In case of issue, a back-up activated carbon tank is also present.

[4] Gao, Y. &. (2015). Assessment of Reynolds Averaged Navier–Stokes Modeling of Scalar Dissipation Rate Transport in Turbulent Oblique Premixed Flames. *Combustion Science and Technology*, 18

[5] Jacob E. Temme, T. M. (2015). Measurements of Premixed Turbulent Combustion Regimes of High Reynolds Number Flames. 53rd AIAA Aerospace Sciences Meetin (p. 21). Kissimmee, Florida : AIAA SciTech Forum.

[6] Buekens, A. (2001). Dioxins from thermal and metallurgical processes: recent studies for the iron and steel industry,. *Chemosphere* 42, 729-735.



### **3.5 Control parameters**

Of course, the dioxin content in the soil is analyzed before and after treatment to assess the treatment effectiveness. However, thermal desorption has already been implemented at the Danang airport and has been proved to be effective against dioxin contamination.

The parameters that are continuously monitored during the treatment are the following:

- The temperature at the coldest points in the thermopiles
- The emissions at all chimneys to guarantee regulatory compliance
- The depression in the pile to ensure proper extraction
- The temperature in the Thermal Oxidizer
- The oxygen content in the Thermal Oxidizer
- The temperature of gases at the quench tower output to avoid dioxin reformation

## **4. Full-scale application**

The pilot project was interrupted by the Covid-19 pandemic and the full-scale application has not started yet.

## **5. Enhancements to SVE**

### **5.2 Any other enhancement**

The Thermal Oxidizer in combination with a heat exchanger can be used to improve the overall thermal efficiency of the thermal desorption process by recovering energy and preheating the combustion air and the vapours themselves.

## **6. Post treatment and/or Long Term Monitoring**

### **6.1 Post treatment and/or Long Term Monitoring**

Post treatment monitoring consists of soil analysis.

Monitoring is based on the extracted vapours as well as temperatures inside the soil.



## 7. Additional information

### 7.1 Lesson learnt

The biggest hurdle in this project was the heavy burden of procedures and authorizations required to perform the actual projects, due to the high sensitivity of the site with respect to its danger and history, as well as the military control over all operations.

### 7.2 Additional information

Even if the project is not finished, it has already been established that thermal desorption is effective against dioxin contamination. The addition of a Thermal Oxidizer improves the Danag process, given that:

- Soil is indeed treated according to standards
- The exhaust gas after thermal oxidation are compliant (no reformation of dioxin)
- No solid nor liquid waste is generated, not needed further off-site disposal

### 7.3 Training need

Training needs are specific both the heating and extraction system, as well as to the Health and Safety measures to be taken on site.

Additional communication is required given the nature of the contaminants in order to fully inform operators and local community about the safety of the process for their own health.

## Glossary of Terms

<b>Term (alphabetical order)</b>	<b>Definition</b>
VTU Vapor Treatment Unit	VTU Vapor Treatment Unit
ppt	part-per-thousand

## 1. Contact details - CASE STUDY: SVE n.2

<b>1.1 Name and Surname</b>	Jean Rhone, Mathieu Petitjean, Alain Duchene, Hatem Saadaoui, Jan Haemers
<b>1.2 Country/Jurisdiction</b>	Belgium
<b>1.3 Organisation</b>	Haemers Technologies
<b>1.4 Position</b>	Innovation Engineer
<b>1.5 Duties</b>	R&D
<b>1.6 Email address</b>	<a href="mailto:innovation@haemers-tech.com">innovation@haemers-tech.com</a>
<b>1.7 Phone number</b>	+32 2 786 39 43

## 2. Site background

### 2.1 History of the site

The site is located in the North of France. It used to be a manufacturing site producing different chemicals, acids and catalysers. Many soil and water investigations were carried out from 1998 to 2015. They showed a presence of impacts of many pollutants in multiple spots of the 0.32 km<sup>2</sup>. The results of those analyses were not different from classic industrial pollution and the main pollutants found were hydrocarbons, BTEX, PAH and heavy metals. The site is located next to agricultural fields and the soil is mainly made of backfills and loam. Once the analyses confirmed the concentrated polluted spots, a “Plan de Gestion” (remediation plan) was drafted, leading to various site uses and different remediation target concentrations.

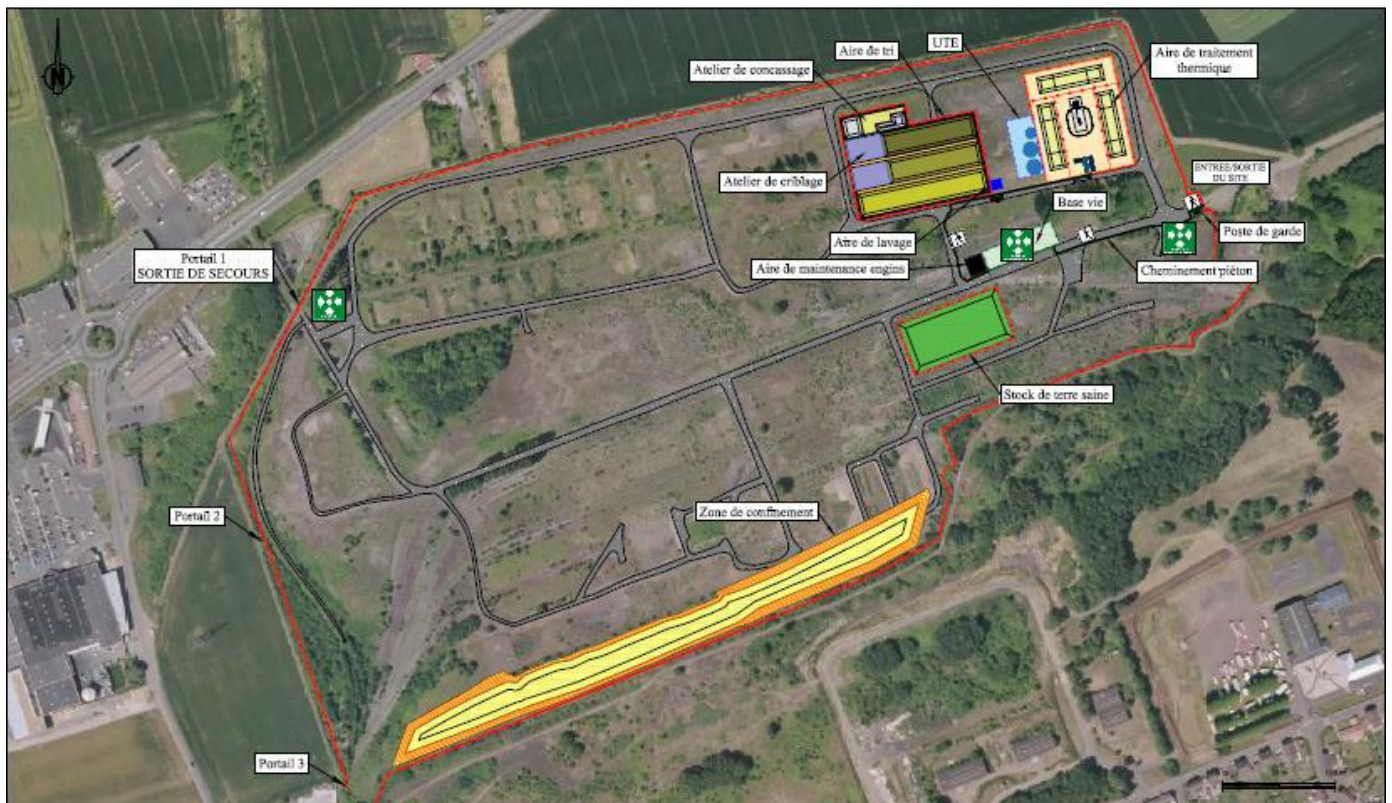



## 2.2 Geological setting

The whole site covers about 34 hectares. It is located between a commercial area and an agricultural area. Indeed, agricultural fields are present at North and East of the site. The main issue with high concentrated spots on a large area is the difficulty to treat all the spots onsite and therefore an Ex-Situ Thermal Desorption (ESTD) was selected. Soils with hydrocarbons concentrations higher than the remediation target were excavated and stored in a single location and eventually erected in several polluted soil piles.

Item	Value	Units
Average Soil Density	1.8	kg/m <sup>3</sup>
Average Porosity	0,3	$V_v/V_T$
Moisture Content	0,24	$\frac{W_{water}}{W_{soil}}$

The thermal treatment area is isolated from groundwater with a waterproof geotextile placed at a depth of 0.4 m. The site's topography was designed to have no accumulation of rainwater in the area. Slight slopes were designed and a rainwater collecting system was constructed to send the rainwater to the water treatment plant.



## 2.3 Contaminants of concern

The contaminants are the COCs identified hereafter:

Contaminant Type	Number of samples	Average concentration (mg/kg DM)	Targets (mg/kg DM)	
C <sub>5</sub> -C <sub>10</sub>			Clay/loam	250
			Backfill	100
C <sub>5</sub> -C <sub>40</sub>	218	4145,5	Clay/loam	2000
			Backfill	1000
BTEX	218	1,16	Benzene	1,5
			Toluene	5
			Ethylbenzene	10
			Xylene	40
HAP	218	30,3	50	

Soils with hydrocarbons concentrations higher than the remediation target were excavated and stored in a single location and eventually erected in several polluted soil piles. The treatment area was chosen to be able to run 2 piles simultaneously, with a third one in mobilization/demobilization.

Because of the client’s concern about Mercury (Hg) soil concentration, a classic ESTD treatment was chosen with the addition of an ad-hoc Vapor Treatment Unit situated at in the middle of the treatment area.

## 2.4 Regulatory framework

The site has been owned by different companies over the course of the last century. A prefectural order was issued in 2015 for the soil remediation in the context of a remediation plan (one commercial and activity area and one park and walking area). The owner issued Golder Associates to be the prime contractor. The contractor chosen by Golder Associates was Seché EcoService, which partnered with Haemers Technologies.



### 3. Pilot-scale application in field

No pilot-scale application was performed

### 4. Full-scale application

#### 4.1 Extraction system

The treatment proposed by Haemers Technologies is a rotating thermopile (ex-situ thermal treatment). Each pile consists of 2000m<sup>3</sup> of polluted soil. In the pile are installed 75 heating tubes and 25 exchanger tubes that transfer thermal energy to the soil. The vapours are extracted by perforated tubes that are connected to a blower in order to generate a low but constant depression sucking the gas out. The typical generated depression is in the order of -0.2 mbar.

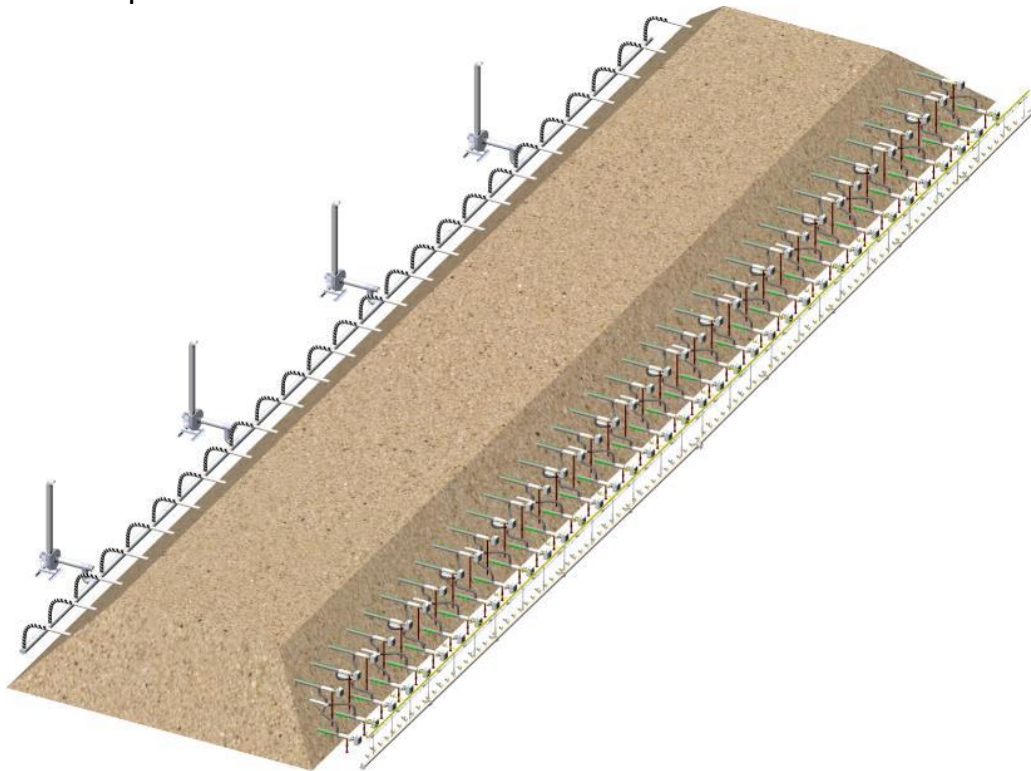





## 4.2 Injection system

In thermal desorption treatment, there is no injection system. The gases are generated when the contaminants and the water are vaporized due to the thermal energy transfer.

## 4.3 Radius of influence

The treatment is effective on the whole pile. Lab tests have shown that if the soil reaches 200°C and that the temperature is maintained for at least 3 days, the target treatment concentrations are met.

The main factor of influence is the interdistance between heating wells in the pile, but they only affect the heating time, i.e. the time needed to reach 200°C. The treatment effectiveness is unchanged.

In this case, the soil vapour extraction wells are approx 1.5m apart. This short range is not the actual radius of influence of each well, as this radius varies in the course of the treatment. As temperature increases, soil is drying out, affecting the permeability to vapours. Therefore, the actual radius of influence of each pipe is likely much larger than 1.5m, even if the applied negative pressure is very low (in the order of 0.2mbar).

The high density of soil vapour extraction wells is commanded by the necessity to collect all vapours despite the low negative pressure and avoid fugitive emissions.

## 4.4 Off gas Treatment

The contaminated vapours are sucked from the pile and transit through the Vapor Treatment Unit (VTU). The VTU is able to handle the off gases of two simultaneous piles. This way, a rotating schedule was implemented where two piles are in treatment while the third is dismantled and the next one is built.

The VTU aims to treat the contaminant's vapours coming from the piles' treatment to stay within national environmental release norms. The VTU is composed of various elements designed to achieve the treatment. Most of the VTU's installation is focused on the contaminant's vapours suction and condensation. The other part is focused on direct treatment through adsorption or thermal oxidation.

The following Figure presents the contaminated vapours flow from the Pile to the VTU.

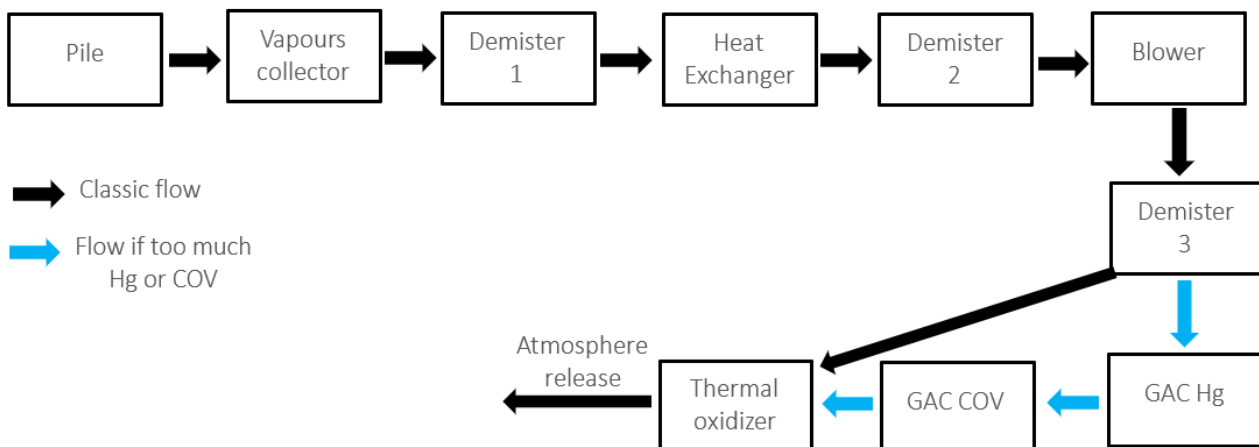

The VTU consists of three demisters and a heat exchanger. The non-condensable vapours (mainly air and light hydrocarbons) are sent to a thermal oxidizer (operating at 820°C), with a residence time of 2 seconds. If high concentration of Mercury is detected, the vapours are routed to a sulphured Activated carbon filter.

The process is partly duplicated to be able to continue the thermal treatment during maintenance of each VTU element. A Programmable Logic Controller was used to automate the switch between the two line.

The next figure will show the duplicated VTU scheme.

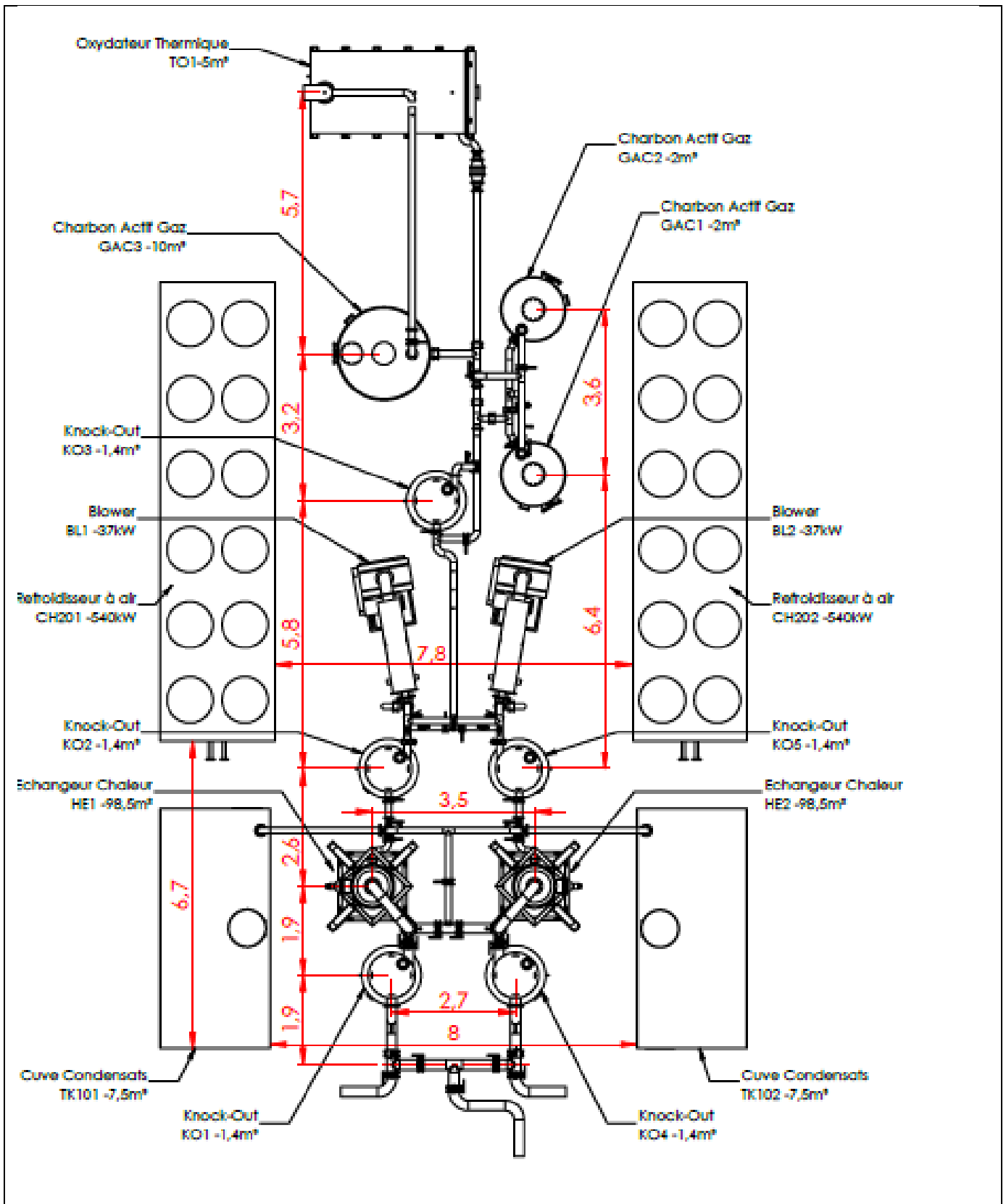

### Vapours collector

One 5" vapour collector was built for each pile. It was made of 10 sections of 6 meters

each. Each collector has a low cant in order to collect the condensates. The collector is connected to an underground tank. Vapour flexible are connected to the collector as shown in the next picture.



The underground tank is connected to an 8" vapour collector that goes to the VTU as shown in the next picture.



Water collected on the underground tanks is sent to the condensate tanks.



## Demisters

A demister equipment is made to remove liquid droplets from gases.

Condensates are collected at the bottom of the tank and sent to be treated by Seché ES. One demister is placed at the VTU entry in order to remove the droplets formed on the 8" collector. One is then placed after the heat exchanger to remove the droplets formed during the vapours' cooling. The final demister is placed after the blower. Indeed, pressure changes in the blower can also create droplets. The aim was to remove humidity before entering the thermal oxidizer.

## Heat exchanger

Installation of one heat exchanger was mandatory for two main reasons: vapour cooling before the blower, water removal using condensation process. In a tubular exchanger, vapours pass through copper thin pipes and gets cool down by water passing between the pipes. Each of the heat exchanger has a 98.5 m<sup>2</sup> exchange surface. Water is then cooled down using a dry air cooler (540 kW). Glycol was added to the water to prevent freezing during winter. The next pictures show the heat exchanger and the dry air cooler.



## Blower

The blower is the most important part of the VTU. Its aim is to depressurize the pile by vacuuming the air and the contaminated vapours. Each of the two blowers was designed to vacuum two piles simultaneously. Thus, each blower has a maximum flow capacity of 3,200 m<sup>3</sup>/h. They are set using one frequency regulator. The maximum acceptable temperature at the input is set to 80°C. The next picture shows one blower.



### **GAC Hg**

Mercury traces were found in previous soil analysis. Exxon suggested Haemers Technologies to provide a solution in order to prevent any mercury atmospheric releases. Two sulphurous activated carbon tanks of 3 m<sup>3</sup> and one Hg analyser (VM-3000) were added to the VTU. The aim was to analyse the vapours after the blower in order to know the mercury concentration. If the concentration was over the norms, an electrovalve redirected the vapour flow to the activated carbon. Another sampling point was placed after the activated carbon in order to assess the mercury removal. The chosen activated coal has an apparent density of 0.63 kg/l and a sulphur concentration of 13-16%. The following picture shows the mercury tanks.

### **GAC COV**

Vapours should be treated through the thermal oxidizer. However, in case of thermal oxidizer breakdown, an activated coal tank of 10 m<sup>3</sup> was added. In case of thermal oxidizer breakdown, the flow was redirected to this new tank. The outlet was connected to the thermal oxidizer's chimney. An activated coal with the following specifications was chosen: apparent density of 0.475 kg/l and US Standard Mesh granulometry of 4\*8. It was chosen to remove COV from the vapours. The following picture shows the tank and its chimney connection.





### Thermal oxidizer

The thermal oxidizer is the key equipment for the vapour treatment. Indeed, the other equipment (except for the GACs) were not chosen for the hydrocarbons removal but mainly to remove the water from the vapours for a better thermal oxidation. Its aim was to remove the pollutants from the vapours and to release clean gases. A residency time of minimum 2 seconds was calculated in order to have an efficient pollutants thermal oxidation. The thermal oxidizer is 5 m<sup>3</sup> and has a 3 meters chimney. It is designed to resist to a maximal temperature of 1,000 °C. A 850 kW burner is connected to the thermal oxidation chamber and fuelled with gas. The burner power is regulated depending on the temperature inside the thermal oxidizer. The normal conditions to have the best pollutants removal efficiency were fixed from 780°C to 820°C. The next picture shows the thermal oxidizer.







## 4.5 Control parameters

The VTU operation is monitored by a Programmable Logic Controller (PLC). The following key data is monitored:

- Vapor temperatures at all steps of the process
- Pile depression to ensure proper aspiration of the vapours
- Pressure points at all steps of the VTU
- Mercury content after the blower
- Gas emissions at the Thermal Oxidizer chimney (COV, CO, NO<sub>x</sub>, PM2.5, PM10, PCDD, HCl, HF, SO<sub>2</sub>)

## 6. Post treatment and/or Long Term Monitoring

### 6.1 Post treatment and/or Long Term Monitoring

Post treatment monitoring consists of soil samples analysis.

## 7. Additional information

### 7.1 Lesson learnt

Special care needs to be taken when operating in countries where below-zero temperatures can be reached. In the case of this project, glycol needed to be mixed with water in the cooling sections.

- It can be beneficial to perform more advanced analysis than the ones provided by the end customer. In particular, the presence of acidic compounds is not relevant per se to the remediation but can damage the equipment.



## 7.2 Additional information

The success of remediation is determined by the compliant pollutants content in the soil after treatment as well as compliant emissions throughout the treatment.

## Glossary of Terms

<b>Term (alphabetical order)</b>	<b>Definition</b>
VTU	Vapor Treatment Unit

## 1. Contact details - CASE STUDY: SVE n.3

<b>1.1 Name and Surname</b>	Luca Sacilotto
<b>1.2 Country/Jurisdiction</b>	Italy
<b>1.3 Organisation</b>	Ramboll Italy S.r.l.
<b>1.4 Position</b>	Senior Managing Consultant
<b>1.5 Duties</b>	Project management of contaminated sites and brownfield assessments for industries; development and implementation of complex remedial projects addressing a wide variety of contaminants in several hydrogeological settings.
<b>1.6 Email address</b>	<a href="mailto:lsacilotto@ramboll.com">lsacilotto@ramboll.com</a>
<b>1.7 Phone number</b>	+39-3341319233



## 2. Site background

### 2.1 History of the site

The site extends over a surface of around 90,000 m<sup>2</sup>, of which around 82,000 m<sup>2</sup> is paved or covered by buildings (buildings cover an area around 41,000 m<sup>2</sup>).

The plant began the production of freezers and refrigerators for food preservation in 1967, production which is still ongoing even if at a reduced rate. The contamination of the site was discovered in 2009 during site characterization activities, and exceedances of the CSC have been identified in deep soils (depth > 1 m bgl) for organochlorinated compounds (vinyl chloride, 1,2-Dichloroethane, Trichloroethylene, 1,2-Dichloropropane), and in groundwater for the following compounds:

- Non-Volatile Metals: Iron, Manganese;
- inorganic compounds: Nitrite, Sulphate;
- BTEX: Toluene, Benzene;
- chlorinated aliphatic compounds: Tetrachlorethylene, Trichloroethylene, Vinyl Chloride, Chloroform, 1,2-Dichloroethane, 1,1-Dichloroethylene, 1,2-Dichloroethylene, 1,2-Dichloropropane, 1,1,2-Trichloroethane.

Furthermore, local areas of buried wastes were found at the site, and removed during subsequent intervention, but it cannot be excluded that additional buried wastes are still present.

## 2.2 Geological setting

Only the shallow portion of soil and groundwater, till a depth of about 15 m b.g.l., was investigated during the site characterization. The subsoil is formed by alluvial deposit formed by interbedded sandy and silty layers as indicated below, overlaying a silty aquitard (see figure below). At a regional scale, a thin semiconfined aquifer contained in a conglomerates formation is present at 70 m b.g.l.

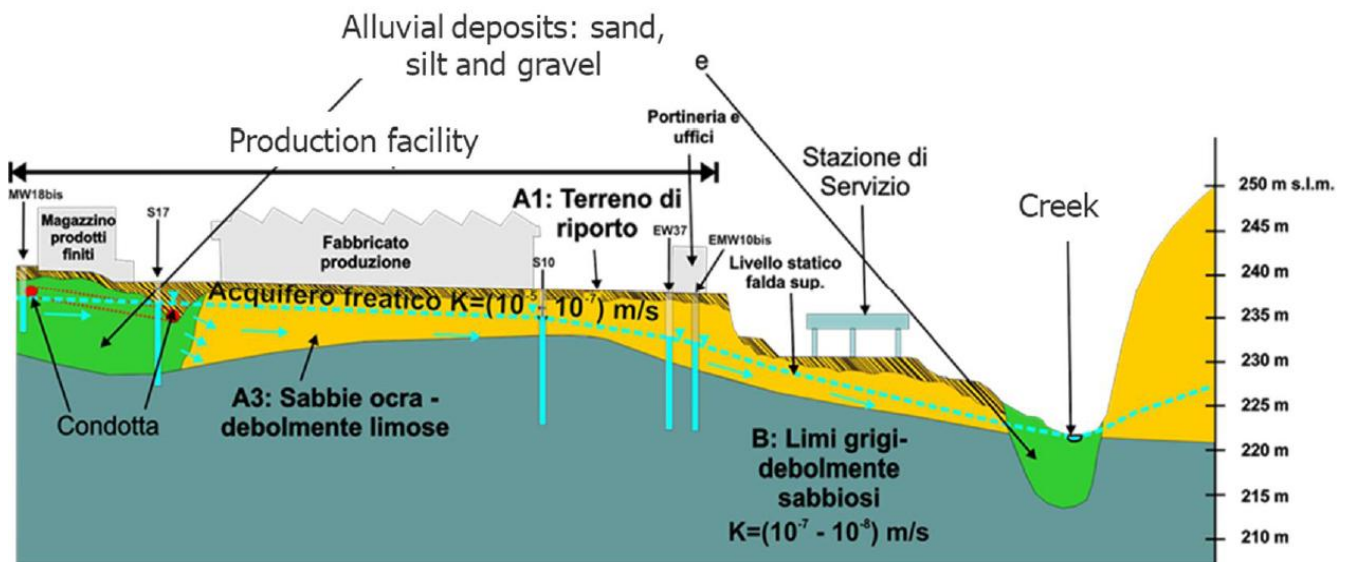

The figure represents the hydro-geological cross-section of the site along the groundwater flow main direction (North-East to South-West).

During site characterization, shallow groundwater levels were ranging between 2 and 9 m b.g.l. (on average 4 m b.g.l.), with flow direction mainly from the upgradient hill (North, North-West) to South, South-Est, towards a Creek; however, groundwater flow at the N-E corner of the facility is affected by the presence of an intubated stream existing at the northern portion of the facility with direction from N-E to S-W, generating a local depression of the groundwater table. Backfilling materials used in the past in earth moving activities for underground installation of the intubated stream appear to be characterized by a low permeability, even if presence of more permeable alluvial materials (sand and gravel) is documented along the pipe at depths between around 8 and 11 m b.g.l. Average groundwater gradient was estimated equal to 3% and hydraulic conductivity ( $k$ ) ranges between  $10^{-6}$  (North-West side) and  $10^{-8}$  m/s (North-Est side), with an average value of  $5 \times 10^{-7}$  m/s.

## 2.3 Contaminants of concern

### Soil:

- vinyl chloride: 0.42 ÷ 0.45 mg/kg
- 1,2-Dichloroethane: 7 ÷ 672 mg/kg
- Trichloroethylene: 20 ÷ 43 mg/kg
- 1,2-Dichloropropane: 27 ÷ 154 mg/kg

### Groundwater:

#### Non-Volatile Metals:

- Iron: 3.1 ÷ 41,400 µg/l
- Manganese: 0.89 ÷ 18,500 µg/l

#### BTEX:

- Toluene: 0.05 ÷ 200 µg/l
- Benzene: 0.053 ÷ 56 µg/l

#### Chlorinated aliphatic compounds:

- Tetrachlorethylene: 0.05 ÷ 38 µg/l
- Trichloroethylene: 0.05 ÷ 31,000 µg/l
- Vinyl Chloride: 0.031 ÷ 410 µg/l
- Chloroform: 0.018 ÷ 69 µg/l
- 1,2-Dichloroethane: 0.018 ÷ 4,800,000 µg/l
- 1,2-Dichloroethylene: 0.054 ÷ 22,000 µg/l
- 1,2-Dichloropropane: : 0.019 ÷ 89,000 µg/l



## 2.4 Regulatory framework

Clean-up goals for soil and groundwater were defined in the Risk Assessment, and are included in the on-going remedial plan, approved in 2012 (the updated approval in 2017 did not modify them).

According to Italian regulation, although the remedial targets are defined on a Risk Assessment basis inside the facility (SSTLs or CSR), groundwater quality at the end of remedial action must comply with regulatory limits (CSC, much more conservative than calculated SSTLs) at the downgradient boundary of the site. Therefore, once reduced the concentration below the CSR for inhalation risk inside the facility, the ultimate clean-up goal for groundwater is to reduce and control the off-site migration at the Southern and Eastern borders of the site. In particular, a general conformity of the Southern border of the site is registered, with an exception at one piezometer at the south-eastern site boundary, where concentrations for TCE are slightly over the potable limit ( $10 \mu\text{g/L}$ ) and one order of magnitude above the regulatory limit (CSC =  $1.5 \mu\text{g/L}$ ). Along the Eastern border, one piezometer exceeds regulatory limits both for 1,2-DCA and 1,2-DCP, with a contamination 2-3 orders of magnitude above the respective regulatory limits (CSC for 1,2-DCA =  $3 \mu\text{g/L}$ ; CSC for 1,2-DCP =  $0.15 \mu\text{g/L}$ ).



### 3. Pilot-scale application in field

No pilot test was performed

### 4. Full-scale application

#### 4.1 Extraction system

The SVE system is composed of two extraction wells and an horizontal trench, and it is combined with an Air Sparging (AS) system which includes four wells. The characteristics of the installed systems are as follows:

- N.2 SVE wells (namely SVE1 and EMW30 both 7 meters deep, with a screened interval from 3 to 7 m bgl. SVE1 is 4" diameter, and EMW30 3");
- N.1 horizontal trench (100 meters long, with a diameter of 200 mm);
- N. 4 AS wells (one close to the trench and EMW30, namely AS1p, and three close to SVE1, namely AS14, AS15, AS16). AS wells are 15 meters deep, and with a 2" diameter. They are all screened in the interval 14-15 m bgl;
- the SVE system is powered by a blower "MAPRO 36/21" (5.5 kW, 220V, triphase 50 Hz);
- the AS system is powered by a scroll compressor "Atlas Copco SF2" (2.2 kW, 220V, triphase, 50 Hz).

#### 4.2 Injection system

As previously mentioned, four injection wells are installed to circulate air in groundwater (Air Sparging) with the scope to strip contaminants that would then be collected by the SVE system. Air is injected at an average pressure of 1 bar.

#### 4.3 Radius of influence

The theoretical value of ROI, calculated in the design phase for the Air Sparging was estimated as 5 to 10 meters.





## 4.4 Off gas Treatment

As for off-gas treatment, there are two granular activated carbon (GAC) filters (1 cubic meter each) in series connection.

## 4.5 Control parameters

- Air flow and extraction rates
- Air pressure measurements
- Water levels
- Dissolved oxygen and contaminant concentrations in groundwater
- Oxygen, carbon dioxide and contaminant concentrations in SVE off-gas or soil vapour
- Mass removal

# 7. Additional information

## 7.1 Lesson learnt

- Low permeability soils difficult to treat through AS technology.
- The presence of heterogeneous subsoil is a big challenge for this types of in-situ technologies.



## 7.2 Additional information

To assess the success of remediation is fundamental to perform:

- trend analysis of each contaminant monitored over time with respect to the initial baseline value
- quantification of extracted mass over time

## 7.3 Training need

To ensure the achievement of remediation goals is fundamental to perform a good operation and maintenance of the overall system. To do that is important that the system is managed by trained personnel. Despite a general training can be done from webinars and e-learning to obtain a targeted training specific for the single system installed few on-the job session, especially in the first weeks of system running, can be a good way to have site personnel sufficiently trained with respect to the specific performances of the system installed.

## Glossary of Terms

A glossary will help a you to maintain the level of precision necessary for key terms and maintain consistency across the text. We found out that sometimes terms that sounds similar like “contaminated” and “polluted” are used in the same way as synonyms in some country, while in other they have different meanings (due to legislation or for other reasons). So fill in this glossary for your key elements and of course for acronyms.

<b>Term (alphabetical order)</b>	<b>Definition</b>
SSTLs or CSR	Site Specific Target Level, which are named CSR in Italian regulation, are concentration target levels defined according to Risk Analysis procedure

## 1. Contact details - CASE STUDY: SVE n.4

<b>1.1 Name and Surname</b>	Luca Sacilotto
<b>1.2 Country/Jurisdiction</b>	Italy
<b>1.3 Organisation</b>	Ramboll Italy S.r.l.
<b>1.4 Position</b>	Senior Managing Consultant
<b>1.5 Duties</b>	Project management of contaminated sites and brownfield assessments for industries; development and implementation of complex remedial projects addressing a wide variety of contaminants in several hydrogeological settings.
<b>1.6 Email address</b>	<a href="mailto:lsacilotto@ramboll.com">lsacilotto@ramboll.com</a>
<b>1.7 Phone number</b>	+39-3341319233

## 2. Site background

### 2.1 History of the site

Since its first installation (1970), within the site have been produced compressors for refrigerators and air conditioning units. The analysis of the production processes within the facility highlighted the use in the past of potentially polluting substances such as heavy metals and chlorinated solvents, mainly PCE, TCE and Cr IV. The production was active up to 2018 and then the assembly lines have been dismantled.

### 2.2 Geological setting

Site soil consists largely of silts and clays interbedded with thicker layers of fine sands. This succession mainly consists of silty-clayey layers with two major sandy layers of different thickness, ranging from few centimetres to about 1 meter, located in the following ranges of depth:

- Level 1: between 10 and 15m b.g.s.
- Level 2: between 25 and 30m b.g.s.

The depth to ground water is approximately 5-7 meters below ground surface.

The following image depict the geological setting of the first two meters of soil subjected to ventilation through the SVE system.





## 2.3 Contaminants of concern

The main compounds of concern are:

- tetrachlorethylene (PCE),
- trichloroethylene (TCE),
- cis 1,2-dichloroethylene (cis 1,2-DCE),
- trans 1,2-dichloroethylene (trans 1,2-DCE),
- 1,1-dichloroethylene,
- chloroform,
- vinyl chloride (VC),
- freon-11,
- freon-113

## 2.4 Regulatory framework

The administrative path of the remediation process started on 2001 when the client informed the Public Authorities of a potential contamination resulting from the presence of chlorinated solvents in groundwater detected during a series of investigations carried out in order to verify the quality of the subsoil at the Site. Subsequently, the following activities have been done: Site Characterization, Preliminary Remediation Design, Final Remediation Design for the treatment of the contamination from groundwater. In 2016 an ambient-air survey highlighted the absence of risks for workers to be exposed to contaminant chlorinated vapours stemming from the contaminated groundwater.

Nevertheless, the client, as a preventive and precautionary measure for workers decided to install a Soil Venting system (same technology of a classical SVE system) to brake any possible migration pathway of contaminated vapours from the groundwater to the productive building.



## 3. Pilot-scale application in field

### 3.1 Extraction system

Before the installation of the full scale system, a pilot scale application has been performed to estimate the effective radius of influence that potentially can be achieved from each extraction well. The test was carried out connecting, through flexible pipes, one vertical well of 4" diameter, 2 m depth screened from 0.5 m below ground level to 2 m depth, with a blower for vapour extraction (with filters and silencers). In addition, the system included a condensate separator to remove water from the extracted gas before to pass through the blower and a granular activated carbon unit (200 L) to treat the contaminated vapour streams before the emission in atmosphere. Moreover, the well head of the extraction well was equipped with a pressure gauge and connected to the extraction system through a flexible pipe. Along the extraction line (2" diameter) there was a manual adjustment valve, vacuum gauge, sampling points and two asameters for air flow measurement.





### 3.3 Radius of influence



Examples of vacuum measurements at wellhead (left) and monitoring point (right)

Two tests were performed to estimate the radius of influence: step test and long duration test.

For the step test increasing flow rates have been considered with values centred around the design value:

- 26 m<sup>3</sup>/h
- 40 m<sup>3</sup>/h (design value)
- 50 m<sup>3</sup>/h
- 80 m<sup>3</sup>/h
- 125 m<sup>3</sup>/h

During each step test, the following parameters were monitored:

- suction depression at the blower,
- depression on the wellhead of the suction point,
- depression induced on the soil gas monitoring points,
- flow rate of extracted gases,
- VOC concentrations.

On the basis of the step test outcomes a flow rate of 60 m<sup>3</sup>/h has been sustained





constant for about 48 hours during which the same parameters of the step tests have been monitored.

Plotting in semi-logarithmic graph the depressions induced in the monitoring points at different distances from the extraction well and considering a cut-off pressure of 1% of the depression measured at the wellhead (Johnson and Ettinger, 1994), namely 0.12 mbar, a ROI of about 120 m has been estimated from the suction shaft considered for pilot test.

### **3.4 Off gas Treatment**

During the pilot scale application in field, off gas were treated by a granular activated carbon unit of 200 L to treat the contaminated vapour streams before the emission in the atmosphere.

### **3.5 Control parameters**

To assess the effectiveness of the treatment the following parameters were monitored during the pilot scale application:

- suction depression at the blower,
- depression on the wellhead of the suction point,
- depression induced on the soil gas monitoring points at different distances from the extraction well,
- flow rate of extracted gases,
- VOC concentrations.

## 4. Full-scale application

### 4.1 Extraction system

The full scale SVE system basically consist of 5 extraction wells, 4 of which within the productive building and 1 in the external area still within the site boundary. Each vertical extraction well is of 4" diameter, 2 m depth screened from 0.5 m below ground level to 2 m depth. Each vacuum well is connected to the vacuum unit through HDPE underground and aboveground pipes of 2", 3" and 4" to take into account pressure drop along the line.

The vacuum unit is basically composed of 2 vacuum blowers (one as backup blower), air flow rate 230 Nm<sup>3</sup>/h each, with filters and silencers, 1 condensate separator to remove water from the extracted gas before to pass through the blower and 1 electrical panel to control the blowers. Outside the vacuum unit there are 2 granular activated carbon units (1 m<sup>3</sup> each with about 600 kg of carbons) and a chimney for treated gas emissions. Each well head is equipped with a pressure gauge and along each of the 5 extraction lines there are from the bottom to the top: sampling port, flow meter, pressure gauge, regulation valve, on/off valve.



Examples of instruments along each extraction line

The system is completed by 32 monitoring points spatially distributed to cover the overall treated area.

To assess the different performances for different monitoring system we installed:

- N. 9 “nesty probes”, 7 of which in external area and 2 within the facility;
- N. 23 “vapor pin” within the facility.



Nesty probe



Vapor Pin



### 4.3 Radius of influence

As a result of pilot test an extraction flow rate of about 50 m<sup>3</sup>/hour for each of the 5 extraction wells has been set and a ROI of about 50 m has been associated with each extraction well in order to cover the planar extension of the groundwater plume which has basically an orientation north-south. The following image depict the expected ROI (brown dotted lines) from each extraction well (green squares).

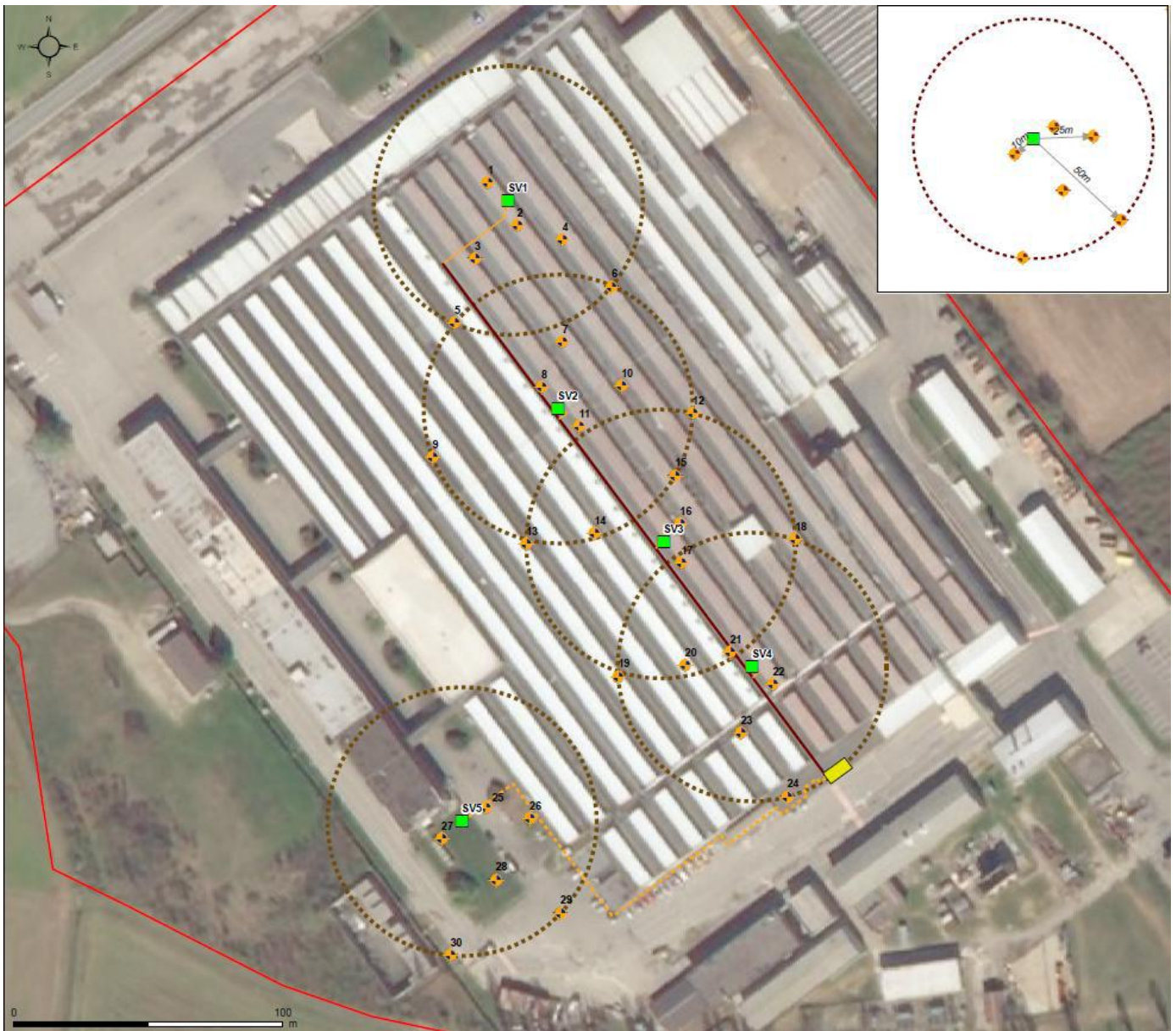

System layout with expected ROI

## 4.4 Off gas Treatment

Off gas treatment is basically composed of 2 granular activated carbon units (1 m<sup>3</sup> each with about 600 kg of granulated activated carbons) and a chimney for treated gas emissions in the atmosphere.





## 4.5 Control parameters

To assess the effectiveness of the treatment the following parameters were monitored with the following frequency

With a weekly basis:

- flow rate of each extraction well,
- temperature and pressure/ suction depression both upstream and downstream the blower,
- the occurrence of condensate waters,

With a 3 months basis:

- VOC, O<sub>2</sub>, CH<sub>4</sub>, CO<sub>2</sub> and depression induced at each monitoring point,
- soil gas concentration for each monitoring point, well heads and off gases before the emission in atmosphere

## 5. Enhancements to SVE

No pneumatic and/or hydraulic fracturing systems has been employed to enhance the SVE application which was designed only to ventilate and hence brake any possible pathways of contaminated streams from the groundwater to the productive building.

## 6. Post treatment and/or Long Term Monitoring

### 6.1 Post treatment and/or Long Term Monitoring

The treatment is still ongoing but as a long term monitoring plan it can be scheduled monitoring campaigns on a six months basis on each soil gas control point available at the site and an ambient-air monitoring survey on a year basis to verify if any changes with respect to the status achieved at the end of ventilation.



## 7. Additional information

### 7.1 Lesson learnt

#### 1) Methodology and procedures

Before the installation of a full scale system perform a pilot test to verify, with field data, the design hypothesis related to ROI extension and flow rate achievable from each extraction well since due to local heterogeneities not all wells perform at the same way.

#### 2) Technical aspects

Prior the installation of the extraction wells perform a detailed screening and review of historical maps of the areas that need to be treated with a sub slab ventilation to assess the occurrence of any subsurface services which can reduce the extension of expected ROI, hence reducing the overall efficacy of the system.

#### 3) Legislative, organizational aspects

To be compliant with regulation limits for off gas emission is key the periodic check of the efficacy of the treatment system to avoid the emission in atmosphere of contaminated gases.

### 7.2 Additional information

To assess the success of remediation is fundamental to perform:

- trend analysis of each contaminant monitored over time with respect to the initial baseline value
- quantification of extracted mass over time

### 7.3 Training need

To ensure the achievement of remediation goals is fundamental to perform a good operation and maintenance of the overall system. To do that is important that the system is managed by trained personnel. Despite a general training can be done from webinars and e-learning to obtain a targeted training specific for the single system installed few on-the job session, especially in the first weeks of system running, can be a good way to have site personnel sufficiently trained with respect to the specific performances of the system installed.



## 1. Contact details - CASE STUDY: SVE n.5

<b>1.1 Name and Surname</b>	Federico Caldera
<b>1.2 Country/Jurisdiction</b>	Italy
<b>1.3 Organisation</b>	Mares S.r.l.
<b>1.4 Position</b>	Analista Sviluppo & Compliance
<b>1.5 Duties</b>	Sanitary and environmental risk assessment, innovative remediation and characterization technologies development
<b>1.6 Email address</b>	<a href="mailto:federicocaldera@maresitalia.it">federicocaldera@maresitalia.it</a>
<b>1.7 Phone number</b>	+39 3497616386



## 2. Site background

### 2.1 History of the site

The site is a gas station in peripheral area south of a city of central Italy, along a road with medium vehicular traffic.





## 2.2 Geological setting

The geological structure of the area is characterized by the presence of soils of volcanic origin and deposits of alluvial origin.

In the area under examination the volcanic deposits of the Pleistocene age produced by the volcanic systems of Lazio emerge.

From a geomorphologic point of view, the site is located on the slope in a hilly area artificially terraced for the construction of the square.

Hydrography essentially consists of a series of ditches which, with dendritic branching, flow north-east. They have a torrential regime, with superficial outflows that occur during intense rainfall and of a certain duration, mainly in the winter season.

The area is characterized in general by soils with variable permeability, both in relation to the variety of soils constituting the stratigraphic succession, and to the frequent variability of the lithological and structural aspects found within the individual units that make up this succession.

The site stratigraphy is characterized by the presence of the following two main units:

- Anthropic material - Mixed material, essentially consisting of medium sand with the presence of gravel/pebbles, which extends from 0 m from ground level. about 3 m b.g.s.;
- Silt and Clays - Cohesive deposit made up of silts and clays with local intercalations of coarser sandy lenses, found up to the maximum investigated depth (10 m b.g.s.).

Literature data allow us to hypothesize the presence of a significant underground water circulation at high depths: in a well surveyed about 400 m south of the gas station area, a water table level of 78 m a.s.l. is reported, corresponding to a depth from the ground surface at the site of about 45-50 m.

## 2.3 Contaminants of concern

Contamination affected unsaturated soil, with BTEX, C<sub>≤12</sub> and C<sub>>12</sub> as CoCs, found at a depth of 3.4 m b.g.s.



## 2.4 Regulatory framework

In Italy the environmental regulatory system is regulated by Legislative Decree No. 152/2006 and for fuel stations by the Ministerial Decree No. 31/2015.

The target values for benzene, toluene, ethylbenzene, xylene, C<12 and C>12 are set equal to 50, 50, 50, 50, 250 and 750 mg/kg, respectively, for soils with commercial use. For the implementation of SVE technology (as well as for the implementation of any remediation plan) the approval by local authorities is needed.

## 3. Pilot-scale application in field

### 3.1 Extraction system

The execution of the pilot test, placing vertical wells SN03 and SN04 (5 meters depth, screened between 1 and 5 m b.g.s.) in depression by a blower, showed that:

- by varying the extraction rate (from 30 to 1000 L/min) within point SN03, rather small depressions were detected in the monitoring points, in any case lower than the value of 0.5 mbar (the maximum value was 0.3 mbar observed in SN04 with an extraction rate of 1000 L/min) indicated by literature as the minimum depression to have an induced influence from the well being extracted (“cut off” value);
- during the test a further test was performed by putting in depression point SN02: also in this case, depressions were observed within the point SN03 lower than the value of 0.5 mbar (the maximum value was 0.2 mbar observed in SN03 with an extraction rate of 2330 L/min);
- no condensation accumulation was detected during the test inside the separator.

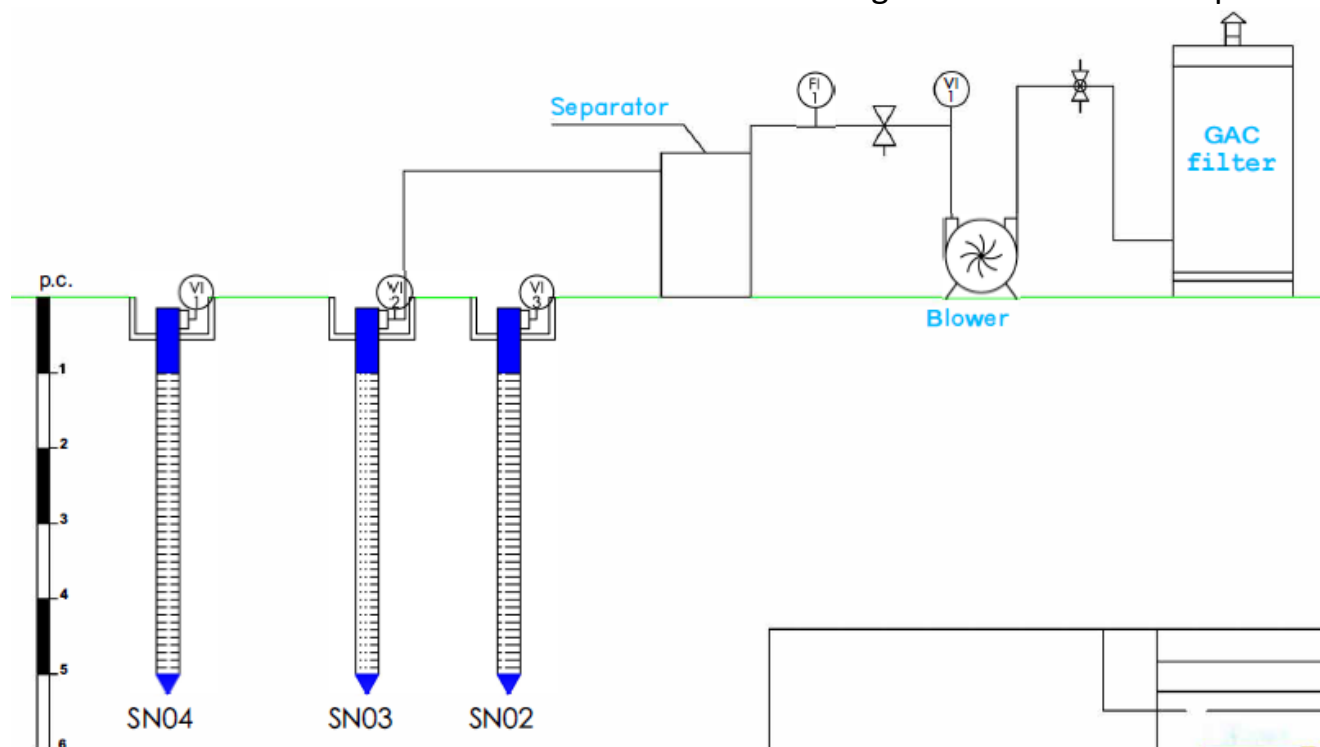

The results obtained by means of the pilot study performed allowed to confirm the applicability of the SVE system to the site. The high permeability of the subsoil to vapor flows, in fact, made it possible to extract significant quantities of air without inducing significant depressions.



### 3.3 Radius of influence

The project parameters, obtained on the basis of the pilot study specifically performed on the site, are the following:

- Radius of influence, ROI: 3.0 m;
- Maximum flow rate of extracted air for each SVE point, Q<sub>Ea</sub>: 70 m<sup>3</sup>/h;
- Working depression at each point, d<sub>Pp</sub>: - 50 mbar.

### 3.4 Off gas Treatment

For the abatement of pollutants present in the extracted air was set, downstream of the air/liquid separation system, a pair of iron with epoxy treatment filters, filled with activated carbon in pellets, (H 1400 mm x D 780 mm).

### 3.5 Control parameters

During the test, the data listed below were recorded:

- extraction rate;
- d<sub>Pp</sub> work-related depression and d<sub>Pi</sub>-induced depression;
- VOC, CH<sub>4</sub>, CO<sub>2</sub> and O<sub>2</sub> in the extraction well.



The number of SVE points is therefore equal to 7. Specifically, the existing piezometers SN02, SN03 and SN04 and the new points VE08, VE09, VE10 and VE11 were used, see the picture below.

The suction from the points was operated by a pump capable of reach a vacuum of at least 150 mbar, and a flow rate of not less than 500 m<sup>3</sup>/h, in order to guarantee an air flow, for each extraction point, of at least 70 m<sup>3</sup>/h, with a nominal power of about 5.50 kW.

### 4.3 Radius of influence

Considering the ROI determined through the pilot test and the areal distribution of the contamination, the number of extraction wells and their spatial location were defined. A correct ROI value of 3 m was therefore adopted as a precaution.

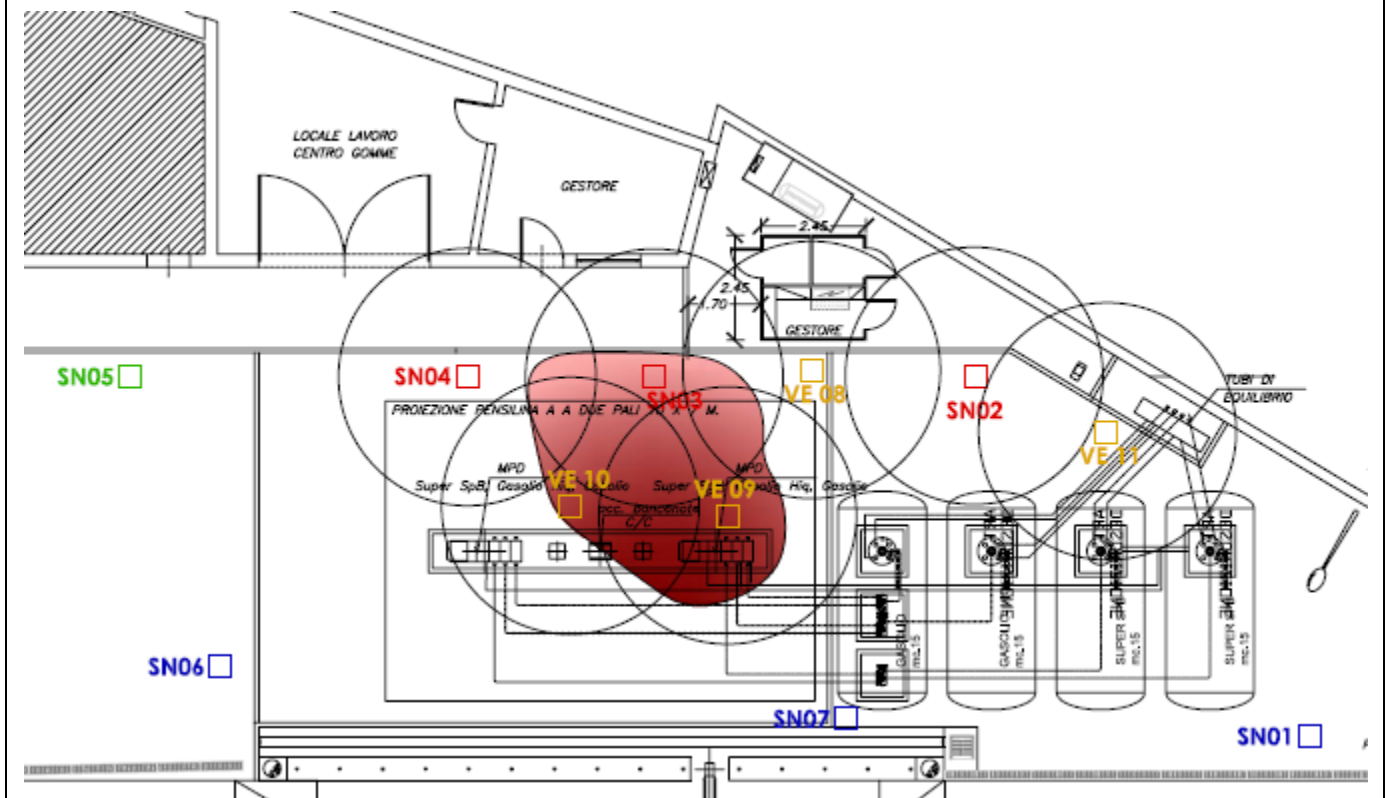

### 4.4 Off gas Treatment

Same of pilot test



## 4.5 Control parameters

Before starting the system, at Time Zero, a complete monitoring was carried out. In particular, the following activities were carried out on all the extraction wells present on site (VE02, VE03, VE04, VE08, VE09, VE10 and VE11):

- measurement of the VOCs present in the extraction points;
- sampling of off air and analysis of parameters such as BTEX and TPH.

During the start up of the system, the following measurements were carried out on a weekly basis:

- measurement of the VOCs extracted from the points and leaving the stack (ppm);
- vacuum induced by the blower (mbar) in the extraction points;
- flows at each extraction point;
- depression induced on the water inside the extraction points.

The start up took about 30 working days and ended with the testing of the air and water treatment system by sampling and laboratory analysis of the vapours entering and leaving the system.

Then, on a monthly basis, control visits were carried out on the plant in order to verify the correct functioning of the system and monitor the operating parameters of the plant (measurement of VOCs, induced depressions, extracted air flows, extracted water flows) making any new adjustments if necessary.

## 6. Post treatment and/or Long Term Monitoring

### 6.1 Post treatment and/or Long Term Monitoring

The periodic monitoring of the SVE system (between 2018 and 2020) provided for:

- control, maintenance and monthly monitoring of the systems and verification of the correct functioning of the system;
- verification and reading of the operating parameters of the system (flows, temperatures, pressures, etc.);
- possible fine-tuning, in the case of variations detected with respect to the operating parameters;
- sampling of air inlet and outlet from the treatment system and analysis of the BTEX and TPH parameters.





## 7. Additional information

### 7.1 Lesson learnt

In presence of a VOC contamination located in a small part of unsaturated soil with a coarse texture the SVE technology can be a viable system to reach the remediation goals.

The intervention was successful - Authorities certification obtained after two years of remediation.

### 7.2 Additional information

The keystone issue for a successful remediation is to gain a right conceptual site model, with a proper definition, in terms of extent, soil texture and presence of preferential flow pathways of the underground contamination source, in order to find adequate technology to properly address and remediate the CoCs.

### 7.3 Training need

Firstly e-learning/webinars in order to understand the theoretical fundamentals of the technology, following training on the job so to gain experience with facing real problems.

## Glossary of Terms

<b>Term (alphabetical order)</b>	<b>Definition</b>
BTEX	Benzene, Toluene, Ethylbenzene, Xylene
C $\leq$ 12	Light hydrocarbons
C $>$ 12	Heavy hydrocarbons
VOC	Volatile organic compounds (VOCs) are organic chemicals that have a high vapour pressure at ordinary room temperature

## 1. Contact details - CASE STUDY: SVE n.6

<b>1.1 Name and Surname</b>	Davide Menozzi, René Filion, Sophia Dore
<b>1.2 Country/Jurisdiction</b>	United States of America
<b>1.3 Organisation</b>	GHD Group Pty Ltd
<b>1.4 Position</b>	Environmental scientist (Davide Menozzi) Senior Project Manager (René Filion) Senior Scientist Innovative Technology Group (Sophia Dore)
<b>1.5 Duties</b>	Contaminated land management
<b>1.6 Email address</b>	<a href="mailto:Davide.menozzi@ghd.com">Davide.menozzi@ghd.com</a>
<b>1.7 Phone number</b>	+61 2 4222 2316 (Davide Menozzi) 01 514 339 0611(René Filion); 716 205 1978 (Sophia Dore)

## 2. Site background

### 2.1 History of the site

Approximately 23,000 kg of acetone was released from a rail car during unloading in July 2016 at a facility that stores, repackages, and distributes chemical products to wholesalers and industrial users.

The Property is irregular in shape, covers an approximate area of 125,000 square meters (m<sup>2</sup>) and is located in a industrial area, with a neighbouring residential area located to the south. This residential neighbourhood is located within 35 meters (m) from the Property limit at its closest proximity. A series of railway sidings are present at and in the western portion of the Site.





## 2.2 Geological setting

The Site stratigraphy in the area of the spill consisted of very shallow fill material extending to 0.6 m below ground surface (mBGS), followed by a layer of natural deposits silt with traces of clay or clay with traces of silt to approximately to approximately 4.5 mBGS. A layer of coarse material composed of sand and gravel measuring approximately 0.3 m thick rests on a grey fractured limestone with fair to excellent rock quality (RQD >95).

Native soils were composed of an initial deposit of silty clay, becoming at around 3 m below ground surface, a deposit composed of more sandy material, either being described as silt with some sand and traces of gravel, or as sand with some silt and gravel.

During intrusive investigations, odours were strongest near the surface (0.6 m to 1.2 m deep) and again near the bottom (4.3 m to 4.9 m deep).

## 2.3 Contaminants of concern

Acetone (primary)

Secondary contaminants:

Ethylbenzene

Toluene

Xylene

## 2.4 Regulatory framework

Following implementation of a Pilot Scale test at the Site that demonstrated effective operating conditions for SVE, a remedial objective of 28 mg/kg was established for acetone in soil, based on similar land use regulatory standards. For the secondary contaminants, existing standards for industrial/commercial land use were selected as remedial objectives ( Ethylbenzene = 50 mg/kg, Toluene = 30 mg/kg, Xylene=50 mg/kg).



## 3. Pilot-scale application in field

### 3.1 Extraction system

One shallow vertical extraction well screened to impart vacuum within the impermeable (shallow) layer of soil were installed throughout the treatment area. The effective radius of influence for these wells was approximately 3 metres. The shallow wells were equipped with 4-inch diameter PVC screens and risers, and terminated near the surface. Two existing 2-inch diameter vertical wells were used to extract vapours from the more permeable and deeper sand and gravel layer as the screened intervals for these wells intercepted the more permeable layer and extended to the top of bedrock/soil interface. The effective radius of influence measured during pilot testing for these wells was approximately 20 m.

A self contained mobile SVE equipment trailer was mobilized to the treatment area. The equipment included a high vacuum, high flow vacuum blower capable of producing up to 100 cubic feet per minute, and a vacuum of 10 inches of mercury, distribution header moisture separator, piping, valves and gauges, barometer, and vacuum gauges. The system was equipped with remote monitoring to the system control panel which could be programmed to run several configurations and on with definable operating timeframes.

### 3.2 Injection system

No injection of air or other substances were permitted.





## 3.3 Radius of influence

### Radius of Influence

The radius of influence (ROI) for each pilot test is estimated based on the vacuum response measured at the SVE monitoring probes and nearby wells, as well as past experience gained from operating SVE systems in similar soils. A probe response of 0.5 to 1.0 percent of the applied SVE wellhead vacuum is generally considered significant in ROI estimation. Due to the soil heterogeneity at the site and surface conditions, a wide range of vacuum response was observed. While vacuum response was achieved in the distant monitoring wells, response at the probes installed in the tighter material was inconsistent and likely masked by fluctuations in ambient barometric pressure.

### Upper Zone

As expected, the soil heterogeneity limited flow and vacuum response in certain directions due to pockets of tight native clays and silts that exist in the subsurface. In the upper zone, the monitoring probes showed a better response to the north compared to the south of SVE-01. The northern portion of the Site showed that an ROI of 3-4 meters would be achievable. The southern portion of the Site showed an ROI of less than 2 meters. ROI estimates showed very similar results when operated between 4 and 10" Hg vacuum. In this zone, the readings indicated that applying a less powerful vacuum may be more beneficial to achieving the best ROI as the 4" Hg vacuum showed the highest induced vacuum readings. The data also suggests that a period of hot, dry weather may have caused desiccation of shallow soils and well seals and resulted in short circuiting of ambient air from the surface. Hydration of surface soils in the pilot test area was successful in reducing the short-circuiting effects.

### Lower Zone

The lower, more permeable zone showed a more significant ROI compared to the Upper Zone. Based on the readings taken, operating at 6" Hg vacuum would provide the greater ROI with distances exceeding 20 meters. Of note, operating at higher vacuums dropped the ROI significantly, to a distance of only 6-8 meters. The extended ROI observed in the lower zone test is likely due to the higher permeability lenses and gravel observed at the top of bedrock in soil borings within the impacted area.

### Air Flow Rate versus Vacuum

Initially, for each step test, the unit was operated for short durations at various flow



rates and corresponding vacuum levels for the purpose of determining the SVE performance over the operating range of the blower and selecting the appropriate flow rate for the test (based on SVE flow rate and wellhead vacuum levels). Flow rate versus vacuum curves were constructed from these step test data to assist in the selection of the most desirable operating range for a full-scale system. An example of the results is shown in the figure below.

### Upper Zone

The step test showed a desirable operating range between 25-40 CFM with an applied vacuum of 4-6" Hg.

### Lower Zone

The step test at PO-101 (see Figure below) displayed good performance without a drop off up to a flow of 40 CFM with an applied vacuum of 8" Hg

AIR FLOW RATE VERSUS VACUUM

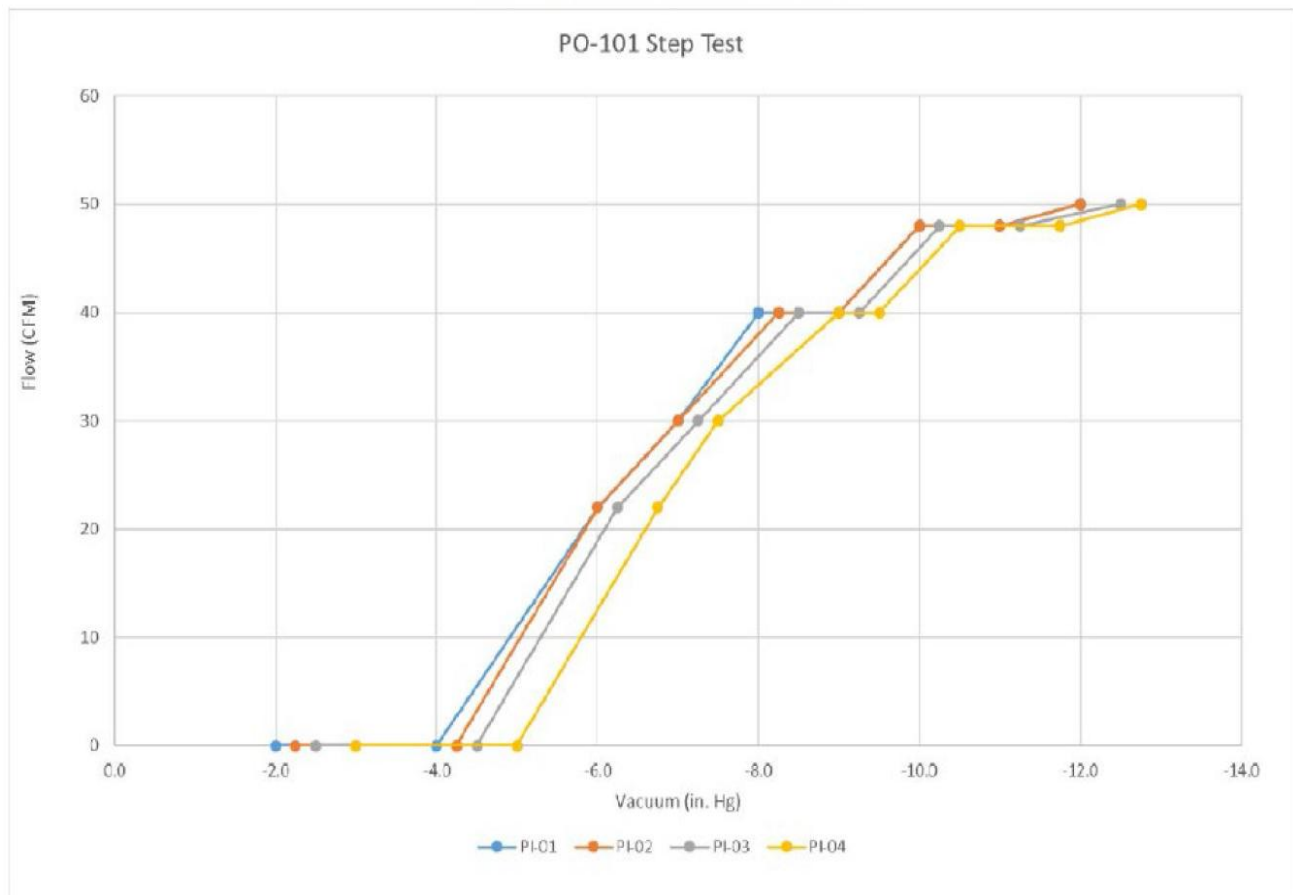



### **3.4 Off gas Treatment**

Extracted vapour treatment was completed using a 205 L drum of activated carbon during the short duration pilot testing period. No samples were collected of the air emissions during the pilot test.

### **3.5 Control parameters**

Soil analytical results were collected prior to and following each treatment phase to evaluate compliance with remedial objectives. These results were also used to configure the following phase of treatment (progressive reduction of treatment area). Groundwater samples were collected and submitted for analysis of volatile organic compounds (VOCs) within and downgradient of the treatment area to monitor for potential releases to groundwater from treatment activities.





## 4. Full-scale application

### 4.1 Extraction system

A total of 8 shallow vertical extraction wells screened to impart vacuum within the impermeable (shallow) layer of soil were installed throughout the treatment area. The effective radius of influence for these wells was approximately 3 m. The shallow wells were equipped with 4-inch diameter PVC screens and risers and terminated near the surface.

Five 2-inch diameter wells were used to extract vapours from the more permeable and deeper sand and gravel layer as the screened intervals for these wells intercepted the more permeable layer and extended to the top of bedrock/soil interface. The effective radius of influence measured during pilot testing for these wells was approximately 20 m.

A self contained mobile SVE equipment trailer was mobilized to the treatment area. The equipment included a high vacuum, high flow vacuum blower capable of producing up to 100 cubic feet per minute, and a vacuum of 10 inches of mercury, distribution header moisture separator, piping, valves and gauges, barometer, and vacuum gauges. The system was equipped with remote monitoring to the system control panel which could be programmed to run several configurations and on with definable operating timeframes.

### 4.3 Radius of influence

Based on the collected field data, the radius of influence of the deeper extraction wells measured was between 9.7 and 18 m, while the radius of influence of the SVE wells was between 5.1 m and 9.9 m.



## 4.4 Off gas Treatment

Discharge vapour monitoring of the system was performed in between and after the two 1,800-pound vapour phase carbon treatment vessels weekly by GHD using a photo ionization detector (PID) for measurement of undifferentiated VOCs.

### **Air Sampling**

In addition to the field PID readings collected above, air samples were collected at the sample port located between the two vapour phase carbon treatment vessels to monitor their performance to ensure that air emissions were below the regulatory limits.

Additional air samples were collected over the course of the SVE treatment in the extracted vapour flow before being treated to evaluate the extracted acetone mass through the vapour stream.

### **Compliance**

PID measurements in between and after the two vapour phase carbon treatment vessels showed readings of 0 ppm throughout the active SVE treatment period.

A dispersion model using SCREEN3 software was completed to assess compliance of air emissions equivalent to 2.5% of the regulatory limit for a 4-min exposure and 1.3% of the regulatory limit for a 1-hour exposure. Analytical results of samples collected throughout the treatment period identified concentrations of acetone reached approximately 1.1% of the permissible exposure rates.

Based on the PID measurements and analytical results from the air samples, air emissions did not present any exceedance of the applicable regulation during the operations of the SVE system.



## 4.5 Control parameters

Soil analytical results were collected prior to and following each treatment phase to evaluate compliance with remedial objectives. These results were also used to configure the following phase of treatment (progressive reduction of treatment area).

Groundwater samples were collected and submitted for analysis of VOCs within and downgradient of the treatment area to monitor for potential releases to groundwater from treatment activities.

## 6. Post treatment and/or Long Term Monitoring

### 6.1 Post treatment and/or Long Term Monitoring

Post treatment groundwater monitoring will be completed three times per year for a minimum of 3 years to evaluate potential impacts to groundwater.

## 7. Additional information

### 7.1 Lesson learnt

SVE was an effective method for remediation of highly volatile contaminants at this Site. The addition of an impermeable ground cover layer effectively controlled short circuiting in the area of highest concentrations immediately adjacent to the spill area.

### 7.2 Additional information

Success of remediation will be assessed in the post-remediation monitoring program.



## 7.3 Training need

Designing a remediation system requires experience. This cannot be easily built up through workshops, webinars and so on. Designing and implementation of a successful remedial system should be undertaken by an experienced company and scientists.

## Glossary of Terms

A glossary will help a you to maintain the level of precision necessary for key terms and maintain consistency across the text. We found out that sometimes terms that sounds similar like “contaminated” and “polluted” are used in the same way as synonyms in some country, while in other they have different meanings (due to legislation or for other reasons). So fill in this glossary for your key elements and of course for acronyms.

<b>Term (alphabetical order)</b>	<b>Definition</b>
VOC	Volatile organic compounds (VOCs) are organic chemicals that have a high vapour pressure at ordinary room temperature
CFM	Cubic feet per minute

## 1. Contact details - CASE STUDY: SVE n.7

<b>1.1 Name and Surname</b>	Hadas Sharon
<b>1.2 Country/Jurisdiction</b>	Israel
<b>1.3 Organisation</b>	Ludan environmental technologies
<b>1.4 Position</b>	Environmental engineer
<b>1.5 Duties</b>	Project manager
<b>1.6 Email address</b>	<a href="mailto:hsharon@ludan.co.il">hsharon@ludan.co.il</a>
<b>1.7 Phone number</b>	+972 52-511-2139



## 2. Site background

### 2.1 History of the site

A gas station operated at the site located in Israel for many years. As part of the change in the designation of the land, from a gas station for a commercial activity area, soil sampling was carried out in the area where underground fuel tanks were located, in order to make sure that the soil was not contaminated.

### 2.2 Geological setting

The following is a description of the geological section in the area:  
0-10 meters - loess and limestone.  
10-300 meters - cardboard, gray mahogany cardboard.

### 2.3 Contaminants of concern

The following are the various contaminants that are suspected in the soil due to the type of activity carried out at the site. These are pollutants that originate from fuel components:

- TPH
- BTEX
- MTBE
- PAH



## 2.4 Regulatory framework

- The subject of soil contamination investigation is the responsibility of a government ministry - the Ministry of Environmental Protection - Department of contaminated soils.
- The soil investigation performed according to the professional guidelines of the Ministry of Environmental Protection, which approves the sampling plan before execution and the conclusions and recommendations given according to the sampling findings.
- The concentrations of the pollutants discovered were compared to the permitted concentrations according to the threshold values document for industrial areas in the State of Israel.

## 3. Pilot-scale application in field

### 3.1 Extraction system

- The system in the ground includes 17 Vertical wells
- The pumping was done using a vacuum truck.

### 3.2 Injection system

- Details of the SVE pilot system infrastructure:
- The system in the ground includes 17 wells with a diameter of 3 inches, to three different depths: 7, 11 and 16 m below the ground.
- The large number of wells and the varying depths allows to "capture" of all the contaminated soil area.
- Each well is constructed so that at its bottom is a fluted section (strainer) 5 m long.
- The pumping was done using a vacuum truck, which was connected to well manifold, so that at each stage the effect of using a single well or several wells simultaneously could be examined by using the SVE system regulating taps.
- The system also included a clean air inlet tap to prevent the creation of underpressure in the pumping wells.





### 3.3 Radius of influence

- The radius of impact was determined by performing pumping until the pressure stabilized, measuring the underpressure in the well being pumped with varying flow rates and measuring the underpressure in the other wells to examine the radius of impact.
- The soil at the site was found to have effective conductivity in the tested flows and the underpressure created allowed the suction of the gases above the ground. At a flow of 150 cubic meters/h, a negative pressure of 74 millibars was measured and the impact radius reached up to 10 meters from the suction well.
- Since the average distance between the wells ranged from 4 to 6 m, there was compatibility between the remediation method, the site characteristics and the existing pilot remediation infrastructure.
- According to the pilot findings, it appears that when operating the pump from all the wells, the entire contaminated soil cell intended for treatment will be underpressure and therefore no additional wells need to be installed.

### 3.4 Off gas Treatment

In order to select the appropriate treatment technology for the airflow from the SVE system, a number of technologies defined as "BAT" (best available technology) (by the EPA) were examined:

1. adsorption on activated carbon
2. thermal oxidation
3. biological filter
4. vapour condensation

Due to the high daily load of organic hydrocarbons, we recommend gas treatment with a thermal oxidation- **catalytic oxygen** method suitable for the treatment of emission stream at concentrations higher than several hundred PPM. Laboratory tests found no evidence of the presence of chlorinated hydrocarbons which can be a limiting factor when using this technology due to the fear of causing damage to the catalytic converter.



### 3.5 Control parameters

- To estimate the load of hydrocarbons pumped from the wells when the SVE system is working, performed gas sampling of several wells together and from a number of individual wells in which high PID values were detected. Some of the samples were performed on canisters sent for TO-15 analysis.
- In order to evaluate the effectiveness of the treatment for the gas pumped from the wells treated by the thermal oxidizer, a sampling was performed on the stack of the treatment facility.

## 4. Full-scale application

The full-scale system is compatible with the system built in the pilot and described in the previous sections

### 4.5 Control parameters

- Throughout the period the system operates, there was regular monitoring once every two weeks of parameters of the system and the soil and once every few months a performed laboratory analysis of TO-15 to the concentrations in the gas stream pumped from the soil.
- The following is the test that is performed every two weeks:
  1. The VOC concentration measured in the well by the PID.
  2. Checking the flow in the pumped stream.
  3. Measuring the pressure in the well.



## 6. Post treatment and/or Long Term Monitoring

### **6.1 Post treatment and/or Long Term Monitoring**

In order to test the effectiveness of the treatment after its completion, a "rebound effect" test was performed, which included shutting down the system for about a month and a half and restarting it for two months.

The test revealed that the concentrations did not rise and there was no change in the concentrations in the various wells after reopening, with respect to values measured before closing. These findings indicate that the treatment performed on the soil is effective and the volatiles that were adsorbed to the soil have already been treated.



## 7. Additional information

### 7.1 Lesson learnt

From the results of the cost-benefit analysis, it can be seen that due to the low concentrations pumped from the soil during the period when the concentration of contaminants decreased, led to high power consumption to operate the system, significantly, as more energy has to be invested in heating the catalyst.

Increased use of electricity to heat the catalyst in the converter causes that per kilogram of pollutant treated emitted into the air during the power generation process at the IEC power plant about half a kilogram of nitrogen oxides and half a kilogram of sulphur oxides.

As the treatment of the site with the SVE method achieved, and the meaning of continued pumping and gas treatment has low efficiency on the one hand and on the other hand requires a lot of energy, its significant environmental consequences with regard to electricity generation emissions.

### 7.2 Additional information

The SVE system operated for about 9,000 hours during which it handled about 5,641 liters of hydrocarbons.

As part of the treatment, about 4,000,000 cubic meters of soil gases were extracted from the ground in the treated area of about 2,000 cubic meters.

### 7.3 Training need

Training through workshops, preferably by the Ministry of Environmental Protection in order for the remediation processes to comply with the regulator's guidelines.

## 1. Contact details - CASE STUDY: SVE n.8

<b>1.1 Name and Surname</b>	VION Mathieu (Expert at Technical Direction) DEVIC-BASSAGET Boris (Technical Director)
<b>1.2 Country/Jurisdiction</b>	FRANCE
<b>1.3 Organisation</b>	SUEZ RR IWS REMEDIATION FRANCE
<b>1.4 Position</b>	Head Office : 17 rue du Périgord, 69330 Meyzieu (France)
<b>1.5 Duties</b>	Engineer - Expertise department manager
<b>1.6 Email address</b>	<a href="mailto:mathieu.vion@suez.com">mathieu.vion@suez.com</a> ; <a href="mailto:boris.devic-bassaget@suez.com">boris.devic-bassaget@suez.com</a> <a href="mailto:contact.remediation.europe@suez.com">contact.remediation.europe@suez.com</a>
<b>1.7 Phone number</b>	+33(4)72450222



## 2. Site background

### 2.1 History of the site

CHIMICOLOR is the former operator of a 1,500 m<sup>2</sup> site located in the town of La Garenne Colombes, in the outskirts of Paris, whose activity involved industrial painting on various supports.

The site is located in a mixed residential and tertiary district, bounded by:

- Apartment buildings on the west side;
- Apartment buildings on the south sides and is separated by a road and pedestrian crossing alley to access the entrance to a residential parking lot;
- A street on the north side, then apartment buildings beyond that street.

According to the information collected, the site was mainly occupied by the following activities:

- 1928 - 1971: Exploitation of the site by a company which carried out the repair and the assembly of electric refrigerators;
- 1971 - 1992: Operation of the premises by a company specializing in the chemical and electrochemical treatment of metals;
- 2001 - 2012: the company CHIMICOLOR becomes the operator of the site and carries out printing activities on aluminium plates, chemical colouring of aluminium plates, stainless steel engraving and screen printing. The cessation of activity took place in 2012.

The site deconstruction work was carried out between May and July 2014. The facade of the building in the north-west part has been preserved as well as the old administrative buildings.

In addition, during the month of July 2014, the soils located to the right of the south-eastern part of the site had been the subject of earthworks to a depth of 1.2 m.

The area to be cleaned up was in the south-eastern part of the land, covering an area of approximately 250 m<sup>2</sup>.



## 2.2 Geological setting

According to the geological map of Paris and the data from the basement database (BSS), the geological context in the sector considered is as follows:

- Old quaternary alluvium;
- Limestone of Saint-Ouen made up of marls and limestone banks over a depth of 10 to 15 m;
- Then the sands of Beauchamp, with a thickness of 6 to 7 m.

The various investigations carried out on the site revealed the following average lithological section:

- From 0 to 1 m: predominantly sandy embankments;
- From 1 to 8 m: a layer of sands becoming marly from a depth of 4 m;
- From 8 m: limestone.

According to information taken from the subsoil database (BSS) and the hydrogeological map of the Paris basin, several water tables are present under the treatment area:

- The Saint-Ouen limestone aquifer, whose piezometric level was established at about 16 m deep;
- The Beauchamp sands aquifer, the piezometric level of which was established at about 24 m deep.

According to the groundwater quality monitoring campaigns carried out in 2012 and 2013, the water levels at the site were recorded between 15.7 and 16.4 m deep in the limestone water table of Saint-Ouen. Due to the location of the site in a bend of the Seine, 2 km north-west and south-east of the site, the flow direction is variable, with a very low hydraulic gradient.





## 2.3 Contaminants of concern

The investigations carried out on the site before the start of the works made it possible to characterize the impact on the right of the area to be decontaminated.

The results summarized below indicated the presence of a tetrachlorethylene impact (PCE):

- In soils. This impact mainly concerned surface soils down to a depth of 1 m (contents at the level of the S6B hole of the order of 4.3 mg/kg). The maximum level (6.7 mg/kg) was observed between 4 and 5 m deep at the level of a borehole located at the level of the former product storage area. The vertical extension of the pollution in the soils was not delimited beyond 6 m of depth but the detection of PCE in the groundwater seemed to suggest that this impact had locally migrated towards the groundwater;
- In soil gases at the level of the most superficial horizons between 0 and 5 m deep. The various campaigns carried out had made it possible to measure PCE contents of between 7.5 and 1,435 mg/m<sup>3</sup>;
- In groundwater in the area of structures located in the area but also on a structure outside the site right-of-way. Studies prior to 2014 revealed PCE contents varying between 3,900 and 8,300 µg/l. According to the groundwater quality monitoring campaigns dating back to 2015 at the site, the PCE contents varied between 100 and 4,100 µg/l. Previous studies had also revealed the presence in small quantities of PCE degradation by-products including trichloroethylene (contents between 0.37 and 8.5 µg/l) and dichloroethylene (content of 4.9 µg/l).



## 2.4 Regulatory framework

The decontamination work was undertaken with the aim of improving the quality of the underground environment (unsaturated zone) before the construction of residential buildings.

As part of this project, the decontamination objectives initially selected, on the basis of data relating to the state of the available environments, were as follows:

- Partly southeast of its site => Excavation of part of the land. According to the predictive analysis of the residual risks carried out in January 2014 by a consulting firm, the only measurement of excavation of the earth at a depth of 3 m was supposed to make it possible to obtain an admissible residual risk within the framework of the redevelopment project of the site (service provided by SUEZ RR IWS REMEDIATION FRANCE in December 2015).
- Forced extraction of PCE present in the soils and in the gaseous state in the air from the soil between the final excavation slope (-3 m compared to the natural ground) and the roof of the limestone of Saint-Ouen (located approximately 8 m deep). The objective of this operation was not to achieve compatible residual risks (which had already to be reached after the excavation work carried out to a depth of 3 m) but to pursue the elimination of the pollution more in depth, with a view to improving the quality of the environments. The initial objective was to achieve an 80% reduction in the mass content of PCE determined in soil gases before the start of treatment with SVE. To achieve this goal, the SVE treatment was scheduled to work over a period of 3 to 6 months.

## 3. Pilot-scale application in field

We did not carry out a pilot sizing test prior to the implementation of the soil vapour extraction treatment.



## 4. Full-scale application

### 4.1 Extraction system

In view of the environmental, geological and hydrogeological context of the site, to treat the source of soil pollution in the area of the former chemical storage area of the CHIMICOLOR plant at La Garenne Colombes, the choice fell on the implementation of an in situ treatment by SVE. This technique had the most relevant technical and economic interest in meeting the objectives of a rapid improvement in the quality of the subsoil.

The forced extraction of gases from the soil was accomplished using 9 wells implanted up to 6 meters deep from the bottom of the excavation, including 2 m in solid tubes and 4 m in screened tubes.

This configuration was determined from the pollution and soil characterization data made available and using sizing assumptions such as:

- The absence of a surface coating (concrete or coated slab) in line with the impacted area;
- A soil permeability estimated at  $5 \cdot 10^{-6}$  m/s;
- Unit extraction rates of 2 to 15 m<sup>3</sup>/h;
- A vacuum at the head of each well less than 150 mbar;
- A provisional treatment period of 6 months.

The unit has been sized so as to be able to ensure a maximum total extraction flow of 660 m<sup>3</sup>/h for a maximum total depression of 350 mbar, compatible with the assumptions stated above.

The installation of the treatment wells was carried out in such a way as to densify the footprint of the treatment wells in the area of the highest impact (premises for chemical etching, storage of products).

The plan below shows the location of SVE wells and treatment facilities.

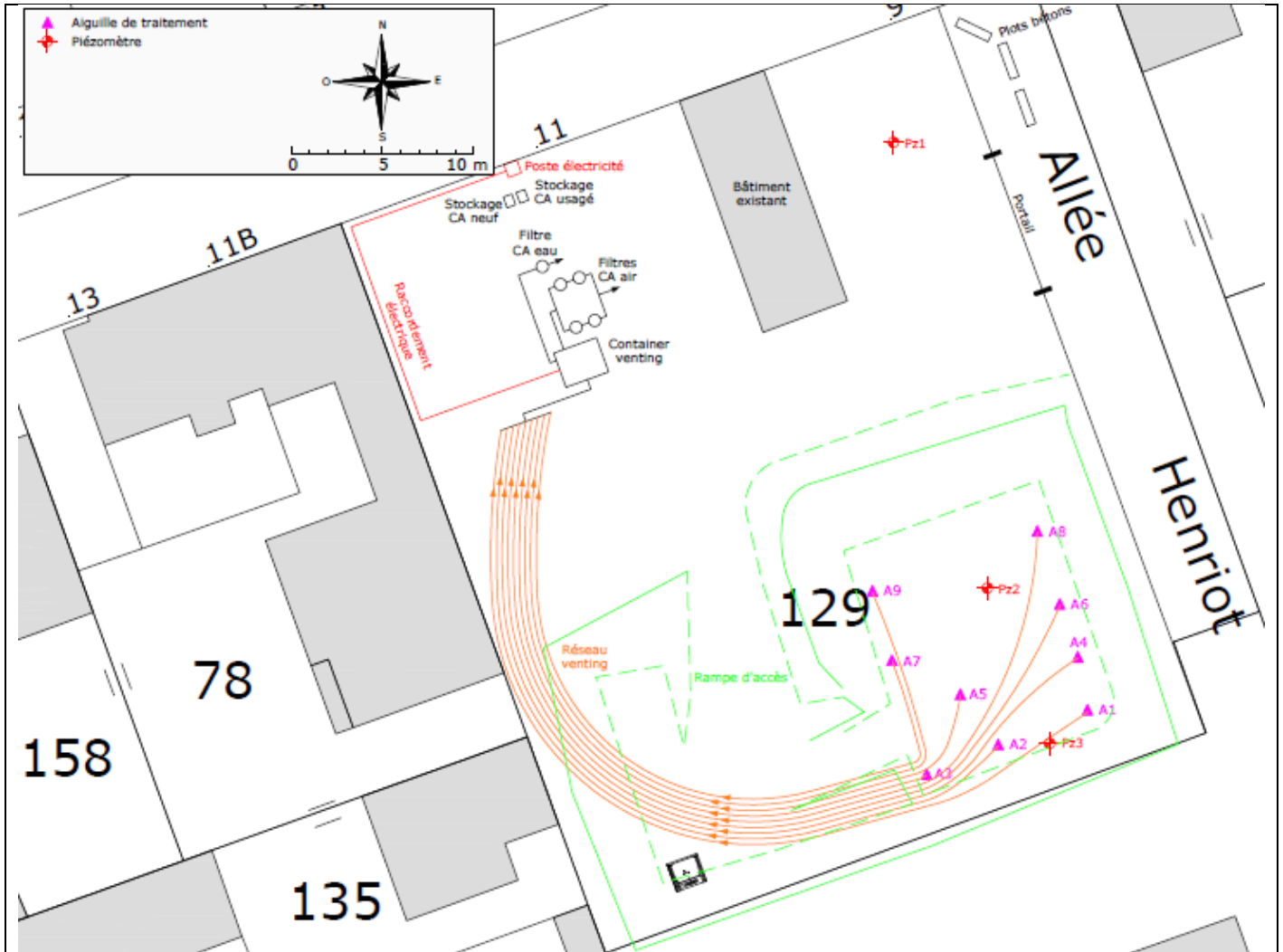

Layout plan for wells and facilities



Photograph of SVE treatment facilities

## 4.3 Radius of influence

Prior to the commissioning of the treatment, SUEZ RR IWS REMEDIATION FRANCE implemented SVE tests in order to determine the characteristics specific to each well (optimal depression/flow rate) and to estimate the permeability of the unsaturated zone to the areas to be treated and thus determine the radius of influence of each well. These data were intended to confirm the sizing of the installation and optimize its performance.

Two types of SVE tests were carried out:

- Staged tests;
- A so-called "long-term" test carried out for 30 hours.

### Staged tests

The objective of a step-by-step test is to determine the optimum vacuum/flow rate pair of the wells. During these tests, the air from the ground was extracted in stages of increasing depressions ranging from 200 to 350 mbar recorded at the level of the extractor. Five successive stages lasting 15 minutes were performed for each hand.

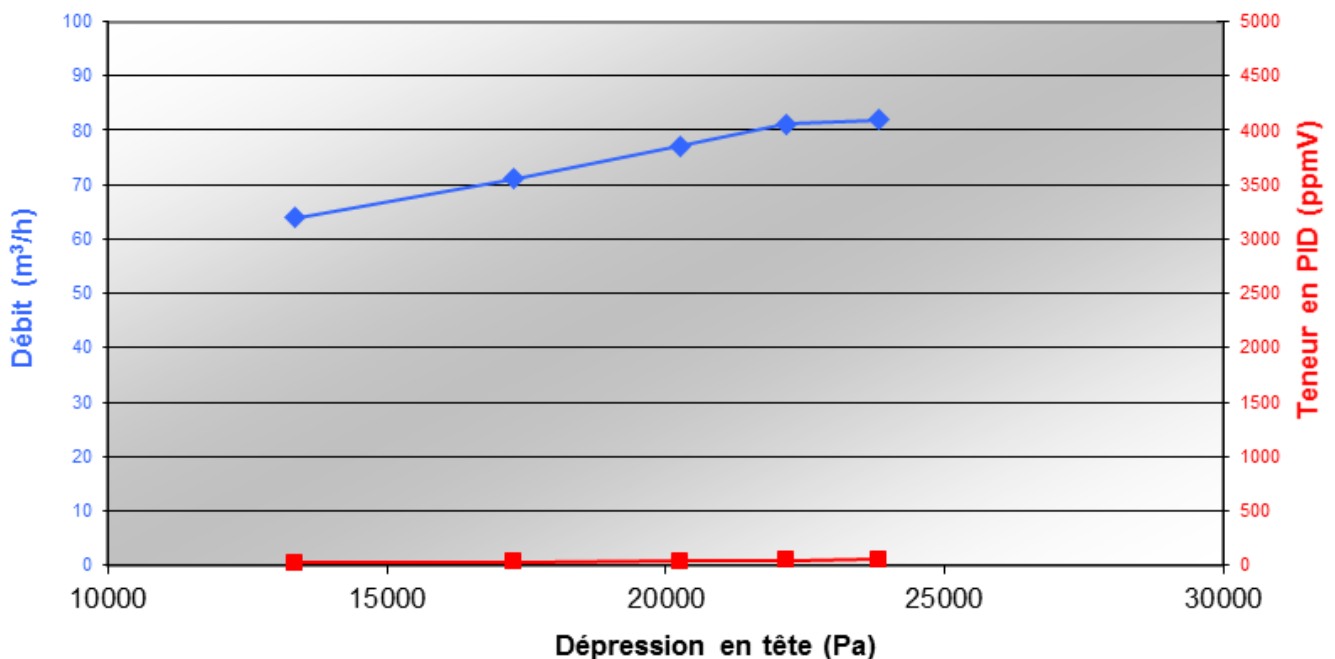

**Vacuum/flow and vacuum/VOC content pairs for well A9**

During the tests, regular monitoring (every 5 minutes) of the following parameters was

carried out:

- Extractor depression;
- Pressure difference in the flow measurement system (diaphragm device);
- Temperature, humidity and semi-quantitative VOC contents of the extracted gases.

For each well, vacuum/flow and vacuum/VOC content pairs could be determined. By way of example, the figure below corresponds to the depression/flow rate and depression/VOC content pairs measured from well A9.

The extraction flow rate increases steadily, going from 64 Nm<sup>3</sup>/h for a depression of 13.367 Pa to 81 Nm<sup>3</sup>/h with a depression of 22.167 Pa. From this last value, and despite an increase depression, the extraction flow hardly increases any more. For 23 833 Pa of depression, the observed flow rate is 82 Nm<sup>3</sup>/h. An asymptote is then observed. The optimum pressure/flow rate pair of the well is therefore of the order of 80 Nm<sup>3</sup>/h for a depression applied at the head of the structure of the order of 22.000 Pa. Well A9 is considered to be a productive well.

The semi-quantitative VOC contents in the gases extracted from this well are not very high compared to the other well tested. The minimum measured concentration is 24 ppmv at step 1 and the maximum concentration is 50 ppmv at step 5.

A summary of the measurements carried out at each well during the stepwise tests is presented in the table below. They correspond to the optimal extraction rate associated with a given depression.

Aiguilles	A1	A2	A3	A4	A5	A6	A7	A8	A9
<b>Dépression optimale appliquée à l'ouvrage (mbar)</b>	190	150	200	<140	240	200	190	230	220
<b>Débit d'extraction optimal (Nm<sup>3</sup>/h)</b>	57	37	44	40	43	36	41	41	81
<b>Teneurs semi-quantitatives PID moyennes (ppmv)</b>	623	429	143	3319	168	335	79	92	37

So-called "long-term" test

The advantage of the "long-term" test is that it can estimate the effective permeability



to air of the soils of the unsaturated zone in line with the zone to be treated. This parameter is essential for determining the radius of influence of each well under operating conditions.

The test was carried out on well A5 which was located in the centre of the area to be treated. The other 8 wells were located between 3.4 and 9.6 m from well A5. A fixed vacuum of 240 mbar was applied for 30 hours from well A5 and semi-quantitative measurements of VOCs and depressions were carried out at close frequency at the start of the test (every 5 minutes) and less frequently by thereafter, on each control well. The defined value of the applied vacuum (240 mbar) was determined by the step test. For well A5, the optimum depression is not known (it is less than 14,000 Pa). On the other hand, at such a depression, we were sure to apply to the well its optimum flow rate estimated at around 40 Nm<sup>3</sup>/h.

#### Estimation of effective air permeability

In order to determine the effective permeability to air of the treatment zone ( $k_a$  expressed in m<sup>2</sup> or permeability K expressed in m/s), various analytical solutions (more or less complex) are proposed in the literature. The configuration of the extraction well and the control wells of the area to be treated made it possible to use the adaptation of Dupuit's solution. This simplified relation derived from that for groundwater flow is used to represent the radial flow of air in steady state.

As the adaptation of Dupuit's solution was only valid in a steady state, the test was extended until the differential pressure values were obtained which were stable over time at the level of the control wells.

The calculated effective air permeability is 9.10<sup>-4</sup> m/s. The value obtained is greater than the value used during sizing (5.10<sup>-6</sup> m/s). This difference made it easier to reach the objectives by allowing more air volume to be extracted from the ground than expected.

#### Estimation of influence radii

By definition, the theoretical influence radius (R1000) of SVE wells corresponds to the radius in which the soil air (pore volume) is renewed at least 1000 times per year. The radius of influence depends on several factors including the geometry of the extraction system, the air permeability of the soil, the water content of the soil and the type of surface coating. Typically, R1000 can range from 2m (for fine soils) to 30m (for granular soils) for a single extraction well.

It should also be noted that the radii of influence of the wells are greater if the ground surface is waterproof (covered with bitumen or concrete), which is not the case in the treatment area of the CHIMOCOLOR site.

A calculation tool internal to SUEZ RR IWS REMEDIATION FRANCE makes it possible to



determine the estimated permeability values by taking advantage of the adaptation of Dupuit's solution. This same tool makes it possible to predict the extractable flow by considering the permeability value, the characteristics of the tested well (depth, length of the screened interval, etc.) and the depression applied at the head of the well. If the flow rate measured at the end of the long-term test is of the same order of magnitude as the calculated flow rate, then the estimated permeability value can be validated.

The results obtained at the end of the long-term test are presented in the table below.

Work	Applied depression	Estimated permeability	Measured extraction flow	Flow calculated according to permeability
AT 5	240 mbar	$9.10^{-4}$ m/s	107.4 Nm <sup>3</sup> /h	168.1 m <sup>3</sup> /h

The permeability value estimated during the long-term test is consistent with regard to the nature of the soils (sands, marls, limestone).

The flow calculated from the permeability estimate is greater than the measured extraction flow (approximately 60 m<sup>3</sup>/h). The geology of the soils could suggest the presence of preferential flows. They are liable to vary the depressions at the head of wells and the unit flows. In addition, the flow rate of 107.4 m<sup>3</sup>/h measured during the "long-term" test is also greater than the flow rate of 43 m<sup>3</sup>/h measured on well A5 during the step tests. These two measured flow rates show the high productivity of well A5 and are much higher than the unit flow rates taken into account for the sizing (between 2 and 15 m<sup>3</sup>/h), which goes in the direction of better efficiency of the treatment.

The permeability thus obtained makes it possible to estimate the radius of influence of each well under operating conditions.

The table below compiles the values of the influence radius obtained under operating conditions of the SVE treatment.

### Summary of the radius of influence calculated under operating conditions

Work	Depression applied at the well head (mbar)	Measured extraction flow (Nm <sup>3</sup> /h)	Radius of influence (m)
A1	27.8	29.9	7.1
A2	29.5	24.5	6.7
A3	32.3	33.8	7.3
A4	43.6	28.9	7
AT 5	28.2	32.1	7.2
A6	41.4	21.3	6.4
A7	36.5	31.0	7.1
AT 8	27.8	36.5	7.5
A9	27.6	28.5	7

The radius of influence obtained from the long-term test and the first operating data are between 6.4 and 7.5 m. Knowing that the maximum distance between two wells is 5 m, the calculated radius make it possible to validate the dimensioning of the SVE well network (number and positioning), namely a total coverage of the area of 250 m<sup>2</sup> in the south-eastern area of the site.

The mapping of the influence radius of SVE wells is presented in the following plan.

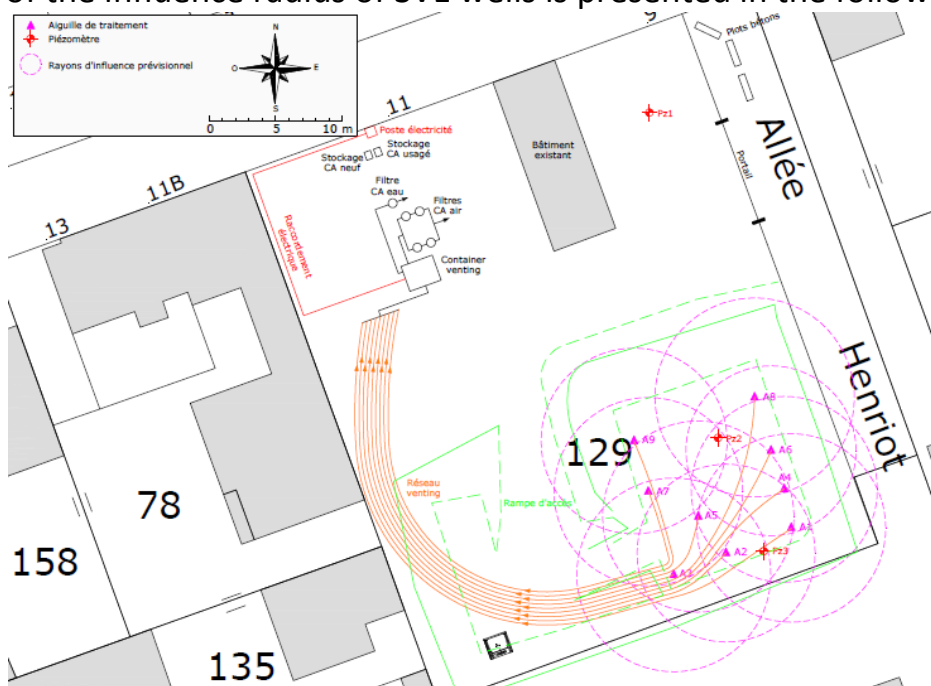



## 4.4 Off gas Treatment

The technical-economic analysis, based on the projected mass balance of the treatment, made it possible to demonstrate that the treatment of the gases extracted on activated carbon was the most economical solution, while allowing a significant reduction in the contents of volatile pollutants.

The initial choice of SUEZ RR IWS REMEDIATION FRANCE fell on a filtration line made up of two series of two 200-liter activated carbon filters arranged in parallel and connected in a common outlet (capacity of 80 kg of activated carbon per filter ). When the activated carbon from the filters placed at the head reached saturation, said filters were emptied, tipped over at the end of the filtration line and then supplemented with healthy activated carbon. Such a device made it possible to measure the VOCs content in the air flow at the outlet of each barrel in order to effectively control the gaseous discharge into the atmosphere and free us from any exceeding of the limit value. In addition, this gaseous effluent treatment device guaranteed reduced downtime for the installation in order to change the activated carbon.

The contaminated activated carbon was evacuated to an approved treatment channel (hazardous waste storage facility).

## 4.5 Control parameters

The figure, below, presents in the form of histograms, the air extraction volume flow rates recorded during monitoring as well as the curve representing the evolution of the cumulative volume of extracted air during the period devoted SVE treatment.

### Evolution of the extraction volume flow rates of the treatment unit and the total volume of extracted air

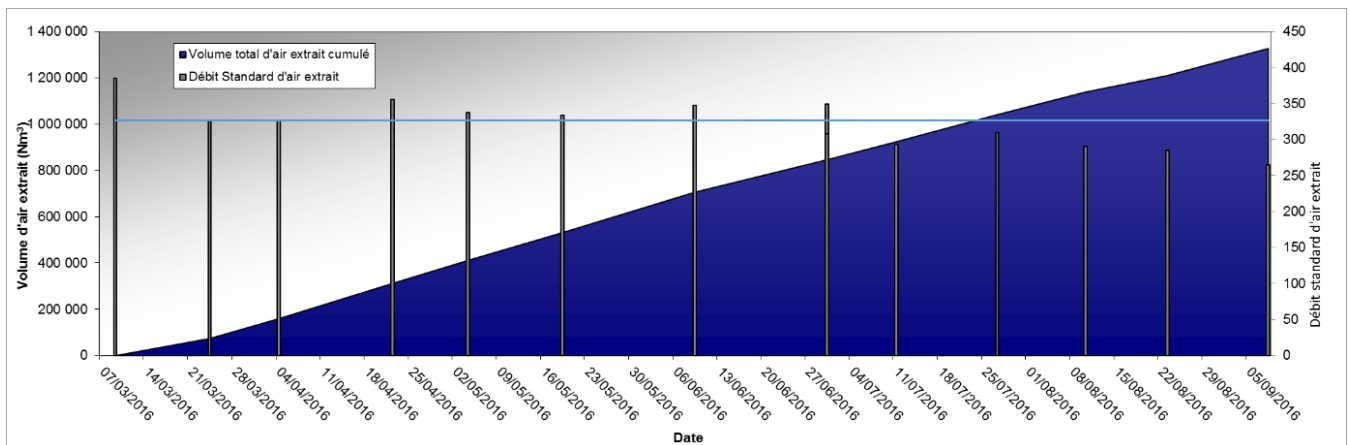

At the end of the operating period of the SVE unit:

- The average volume flow rate of air extraction estimated over the six months of operation is 327 Nm<sup>3</sup>/h (blue line shown in the figure above);
- The total volume of air extracted from the ground is estimated to be approximately 1,328,000 Nm<sup>3</sup>.

The figure below shows the evolution of the volume contents of VOCs measured by means of a photo ionization detector (PID) in the air flow extracted from each of the treatment wells as well as in the global air flow input to the unit during the operating period of the SVE treatment.

### Evolution of the volume contents of VOCs in the air flow extracted from each treatment well

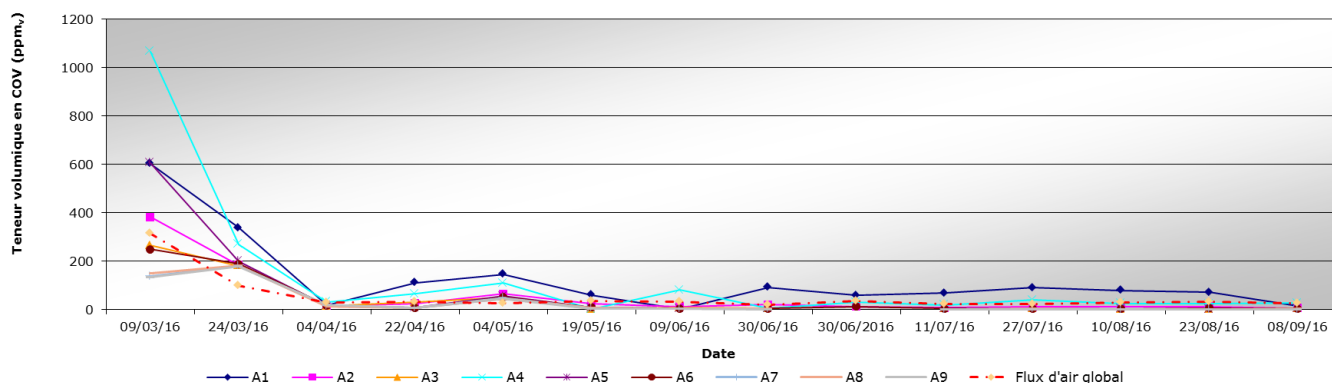

The volumetric VOC contents remained relatively stable after the significant decrease observed during the first month of treatment. After 6 months of treatment, the extracted air streams exhibited contents ranging between 1.1 ppmv for well A9 and 26.6 ppmv for well A4.

Monthly, air sampling, on a suitable sampling support (activated carbon tube) was carried out at the inlet of the activated carbon filtration device. This sampling made it possible to determine, through the performance of laboratory analyzes, the mass contents of VOCs in the overall air flow extracted from the ground via the treatment wells.

The table below compiles the analytical results obtained from the samples taken during the period devoted to SVE treatment.

### Mass content of VOCs in the extract air flow

	09/03/2016	04/04/2016	04/05/2016	09/06/2016	11/07/2016	10/08/2016	08/09/2016
Unité	mg/Nm <sup>3</sup>	mg/Nm <sup>3</sup>	mg/Nm <sup>3</sup>	mg/Nm <sup>3</sup>	mg/Nm <sup>3</sup>	mg/Nm <sup>3</sup>	mg/Nm <sup>3</sup>
1,2-dichloroéthane	<SQ	<SQ	<SQ	<SQ	<SQ	<SQ	<SQ
1,1-dichloroéthène	<SQ	<SQ	<SQ	<SQ	<SQ	<SQ	<SQ
cis-1,2-dichloroéthène	<SQ	<SQ	<SQ	<SQ	<SQ	<SQ	<SQ
trans 1,2-dichloroéthylène	<SQ	<SQ	<SQ	<SQ	<SQ	<SQ	<SQ
dichlorométhane	<SQ	<SQ	<SQ	<SQ	<SQ	<SQ	<SQ
1,2-dichloropropane	<SQ	<SQ	<SQ	<SQ	<SQ	<SQ	<SQ
1,3-dichloropropène	<SQ	<SQ	<SQ	<SQ	<SQ	<SQ	<SQ
tétrachloroéthylène	1490,8	193,6	107,4	101,0	66,6	74,2	99,2
tétrachlorométhane	<SQ	<SQ	<SQ	<SQ	<SQ	<SQ	<SQ
1,1,1-trichloroéthane	0,7	0,2	0,1	0,1	0,1	0,1	0,6
trichloroéthylène	2,0	0,3	0,1	0,1	0,1	0,1	0,2
chloroforme	<SQ	<SQ	<SQ	<SQ	<SQ	<SQ	<SQ
chlorure de vinyle	<SQ	<SQ	<SQ	<SQ	<SQ	<SQ	<SQ
hexachlorobutadiène	<SQ	<SQ	<SQ	<SQ	<SQ	<SQ	<SQ
bromoforme	<SQ	<SQ	<SQ	<SQ	<SQ	<SQ	<SQ
<b>TOTAL COHV</b>	1493,5	194,1	107,6	101,2	66,7	74,4	100,0
Teneur PID lors du prélèvement	315,0	32,1	26,0	27,0	28,0	29,0	30,0
Pourcentage d'abattement sur les COHV totaux par rapport au 09/03/2016	NA	87%	93%	93%	96%	95%	93%



<SQ: below the quantification threshold

NA: Not applicable

During the follow-up on September 8, 2016, i.e. before stopping the treatment device, the tetrachlorethylene content (a compound present at 99% in the air flow since the start of the treatment) had significantly increased compared to the levels determined from the samples from July 11 and August 10, 2016.

The total COHV content determined during the monitoring of September 8, 2016 was 100 mg/Nm<sup>3</sup> and revealed a reduction percentage of 94% compared to the content measured on March 9, 2016, the day treatment was started.

An indicative value of the total mass of pollutants extracted could be calculated on the basis of analytical monitoring and air volumes extracted from the soil by the SVE system. The calculations only take into account the organic compounds analyzed.

The table below shows the detail of the estimate of the masses of VOCs extracted from the ground, in gaseous form, by the SVE device, on the basis of the data collected from the start of the treatment until its stop, the September 08, 2016. The average concentration over each period was calculated from the two air samples taken at the inlet of the activated carbon filters and limiting the monitoring period.

### Mass balance of pollutants extracted from the ground by the SVE device since the start of treatment

Paramètre	Unité	1 <sup>er</sup> mois de suivi	2 <sup>ème</sup> mois de suivi	3 <sup>ème</sup> mois de suivi	4 <sup>ème</sup> mois de suivi	5 <sup>ème</sup> mois de suivi	6 <sup>ème</sup> mois de suivi
		Du 09/03/2016 au 04/04/2016	Du 04/04/2016 au 04/05/2016	Du 04/05/2016 au 09/06/2016	Du 13/06/2016 au 11/07/2016	Du 11/07/2016 au 10/08/2016	Du 10/08/2016 au 08/09/2016
Volume d'air extrait période	Nm <sup>3</sup>	158 680	251 512	294 716	217 678	216 489	188 984
Concentration moyenne en COHV sur la période (échantillonnage mensuel)	mg/Nm <sup>3</sup>	843,8	150,8	104,4	84,0	70,6	87,2
Masse totale en COHV extraite période	kg	134	38	31	18	14	16
Taux d'extraction journalier	kg/j	5	1	1	1	0,5	0,6
Masse totale extraite cumulée	kg	134	172	203	221	235	251

As of September 8, 2016, the date of termination of the SVE treatment system, it is estimated that approximately 251 kg of VOCs were extracted from the soils in gaseous form.

## 6. Post treatment and/or Long Term Monitoring

### 6.1 Post treatment and/or Long Term Monitoring

Following the six months of treatment and in accordance with the acceptance strategy for the decontamination works, a statement of the quality of the soil gases was carried out monthly for 3 months from each treatment well in order to quantify the level of pollution. of soil gases by VOCs and to monitor the possible evolution of the levels, once the device has been shut down.

Evolution of the volume contents of VOCs in static conditions from the initial state (09 March 2016) until the last monitoring campaign of the reception phase (06 December 2016)

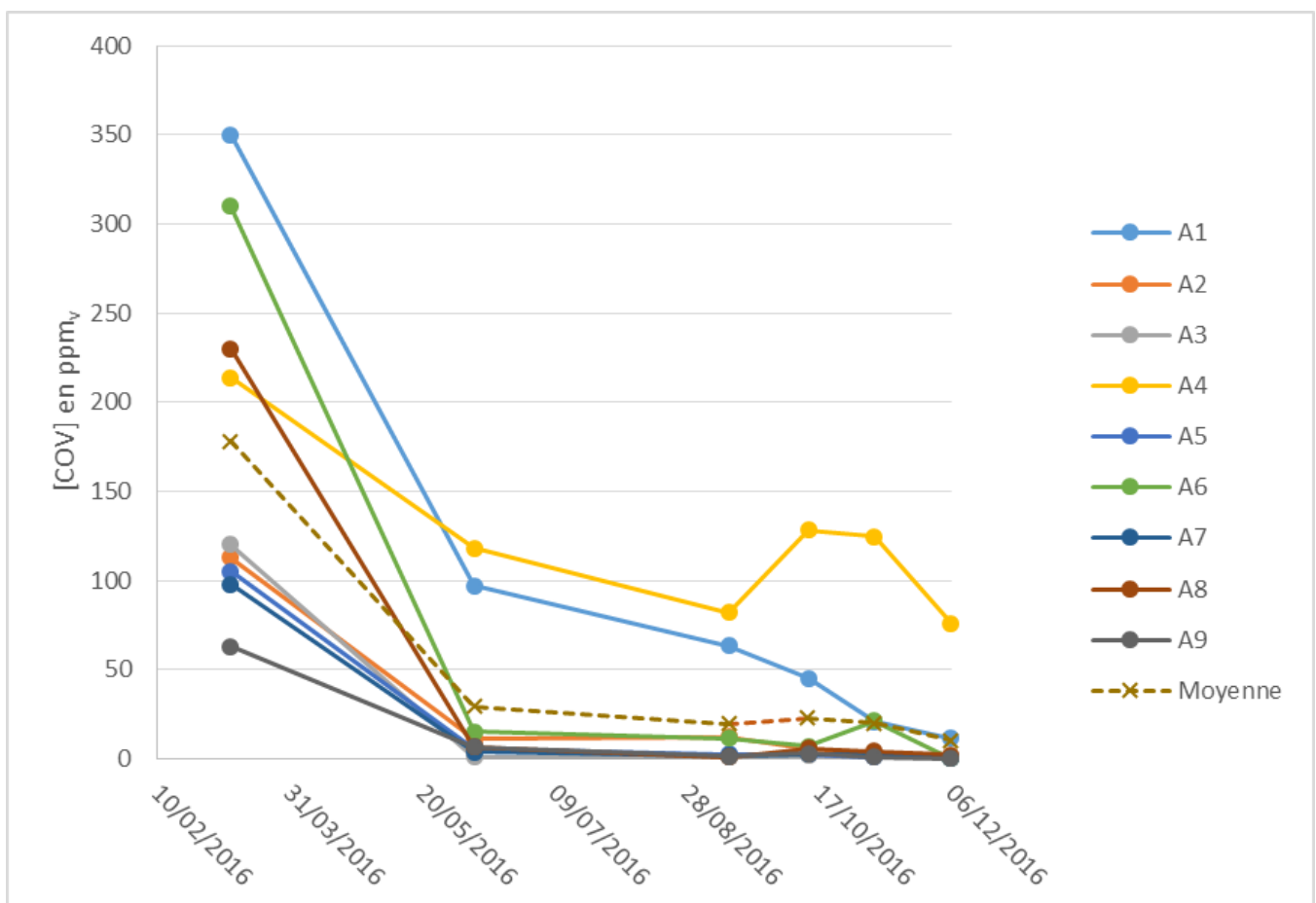



**Evolution of the VOC mass contents under static conditions from the initial state (09 March 2016) to the last monitoring campaign of the reception phase (06 December 2016)**

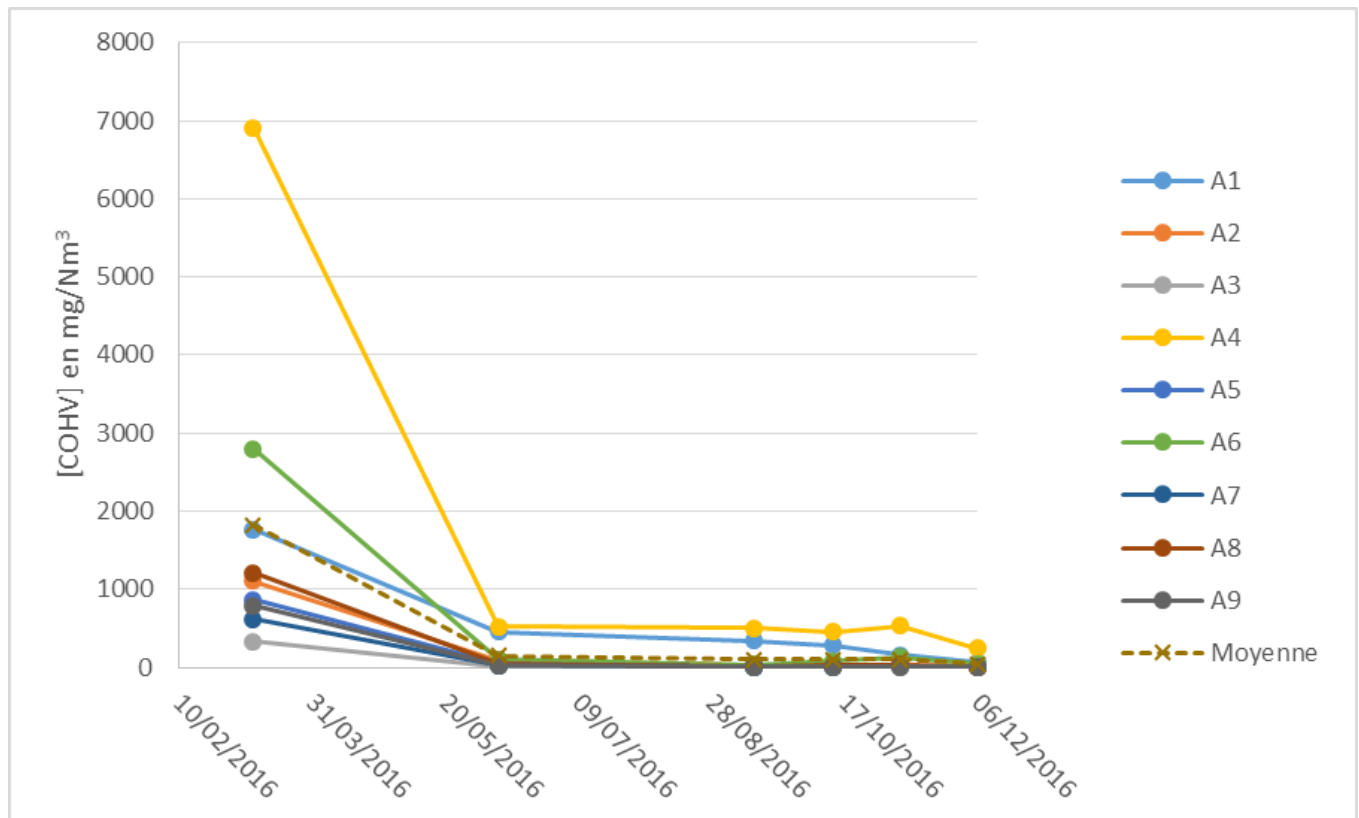

After 6 months of treatment, the average VOC content in the soil gases sampled from the 9 SVE wells was 108.23 mg/Nm<sup>3</sup>. This value remains relatively high. Despite everything, in comparison with the value obtained before the start-up of the installations, the reduction rate of the average of the total VOC contents amounts to 94%. The results obtained demonstrated good efficacy of the treatment.

The VOC contents in the soil gases sampled from each of the 9 wells ranged, after 6 months of treatment, between 3.04 mg/Nm<sup>3</sup> for well A3 and 507.36 mg/Nm<sup>3</sup> for well A4. All the wells exhibited an abatement rate greater than 93%, with the exception of well A1 which exhibited an abatement rate of 81% for a measured concentration of 338.04 mg/Nm<sup>3</sup>.

The treatment of soil gases by SVE was stopped at the end of the soil gas sampling campaign carried out on September 13, 2016, in accordance with the work acceptance strategy. The operating mode consisted of keeping the installation shut down for a period of 3 months. During this period, and in a manner identical to the samples taken



during the initial state and after 3 and 6 months of treatment, soil gas samples at the 9 wells were taken and analyzed on a monthly basis.

After 3 months of stopping treatment, the average VOC content in the soil gases sampled from the 9 SVE wells was  $42.86 \text{ mg/Nm}^3$ . This value is lower in comparison with the value obtained after stopping treatment, on September 13, 2016 and in comparison with the values obtained after one and two months of stopping, on October 13 and November 7, 2016. In the end, the reduction rate for the average VOC content is 98%, which corresponds to a significant reduction rate, clearly higher than the target (80%). The VOC contents in the soil gases sampled from each of the 9 wells range, after three months of shutdown, between  $1.97 \text{ mg/Nm}^3$  for well A9 and  $245.04 \text{ mg/Nm}^3$  for well A4. All the wells had an abatement rate greater than 97%.

At the end of the final soil gas quality monitoring campaign carried out on December 6, 2016, tetrachlorethylene still remains the majority compound. We can also note that 1,1,1-trichloroethane was measured in trace amounts at wells A4, A5, A6 and A8. Likewise, trichloroethylene was also measured in trace amounts in the area of wells A1, A4, A5, A6, A8 and A9.

## 1. Contact details - CASE STUDY: SVE n.9

<b>1.1 Name and Surname</b>	VION Mathieu (Expert at Technical Direction) DEVIC-BASSAGET Boris (Technical Director)
<b>1.2 Country/Jurisdiction</b>	FRANCE
<b>1.3 Organisation</b>	SUEZ RR IWS REMEDIATION FRANCE
<b>1.4 Position</b>	Head Office : 17 rue du Périgord, 69330 Meyzieu (France)
<b>1.5 Duties</b>	Engineer - Expertise department manager
<b>1.6 Email address</b>	<a href="mailto:mathieu.vion@suez.com">mathieu.vion@suez.com</a> ; <a href="mailto:boris.devic-bassaget@suez.com">boris.devic-bassaget@suez.com</a> <a href="mailto:contact.remediation.europe@suez.com">contact.remediation.europe@suez.com</a>
<b>1.7 Phone number</b>	+33(4)72450222



## 2. Site background

### 2.1 History of the site

The site where the SVE clean-up project was carried out is confidential.

The site is located in the Ile-de-France region, in France. The site covers an area of several hectares and corresponds to a multidisciplinary research and innovation centre. The activities carried out concern many fields such as nuclear energy, life sciences, material sciences, climate and environment, technological research and education. The area of the site mainly affected by the presence of VOCs (mainly trichloroethylene – TCE) in the subsoil is located in the extreme south-eastern part of the centre.

### 2.2 Geological setting

The geological and hydrogeological information collected during the previous studies are reported in the following table.

Geological information	Hydrogeological information
<p>The horizons intersected by the wells on site are successively:</p> <ul style="list-style-type: none"> <li>• a very poorly permeable cover formation, corresponding to plateau silts and grindstone clays, with a thickness of around 12 m;</li> <li>• the Fontainebleau sands, corresponding to very well classified fine sands (particle size of 500 to 600 <math>\mu\text{m}</math>); the thickness of Fontainebleau sands formation is around 50 m; a carbonate and clayey horizon, with a thickness generally between 1 and 2 m, is present in the upper part of the Fontainebleau sands formation, at a depth of the order of 14 to 15 m.</li> </ul>	<p><b>Aquifers:</b> formation of the Fontainebleau sands</p> <p><b>Static level:</b> the free surface of the water table is intercepted at a depth of 40 m.</p> <p><b>Flow direction/gradient:</b> the flow of the groundwater table is directed towards the south</p> <p><b>Hydrodynamic data:</b> no data is available</p>



## 2.3 Contaminants of concern

Under the effect of the diffusion within the Fontainebleau sands, which are very permeable to air and which are isolated from the atmosphere by a confining geological layer of a dozen meters thick, a halo of VOCs (mainly trichloroethylene - TCE) was formed within the pore space of the Fontainebleau sands, in the sector of the main source zone identified, that is to say in the extreme south-east of the site.

The TCE halo partially dissolves on contact with groundwater. The plume of VOCs, multi-source and multi-pollutant, affects groundwater at the scale of the site.

Pollution characterization data remain unknown, namely:

- the position of the historical area of solvent infiltration in the subsoil;
- The nature and quantities of the VOCs that have reached the subsoil;
- the nature of the polluting events that led to the infiltration of VOCs into the subsoil.

## 2.4 Regulatory framework

The main objective of the client is to improve the quality of groundwater and overall improve the quality of the underground environment, with a view to reducing the sources of pollution of the underground environment in accordance with the French national methodology for the rehabilitation of sites and soils polluted.

To achieve this, the client commissioned the company SUEZ RR IWS REMEDIATION FRANCE to carry out the forced extraction of TCE present in the gaseous state in the air from the soil between 15 and 40 m deep, within the Fontainebleau sands formation, in the south-eastern part of the site.

## 3. Pilot-scale application in field

We did not carry out a pilot sizing test prior to the implementation of the soil vapour extraction treatment.

## 4. Full-scale application

### 4.1 Extraction system

The forced extraction of gases from the ground was accomplished from the three wells named F51, PG-05 and PG-08. These wells are respectively 50 m, 20 m and 30 m deep in relation to the surface. The screened intervals of these wells intercept the Fontainebleau sands. The treatment unit was dimensioned so as to be able to ensure a maximum extraction flow rate per well of the order of 150 to 200 m<sup>3</sup>/hour. In addition, given the configuration of the screened intervals of the PG-05 and PG-08 wells, SUEZ RR IWS REMEDIATION FRANCE has provided specific plugs and wellheads in order to selectively extract gases from the soil in the Fontainebleau sands formation overlying or underlying the carbonate and clay horizon generally intersected between 14 and 16 m deep.

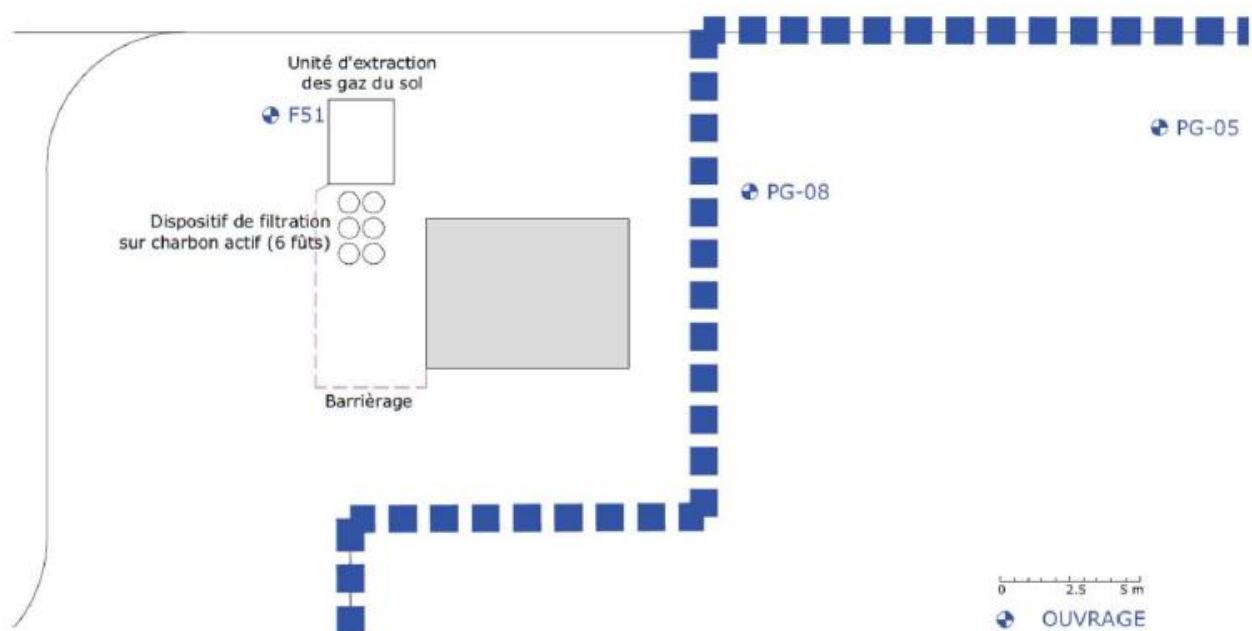

**Layout plan for wells and facilities**







### **4.3 Radius of influence**

We did not determine the radius of influence of the treatment wells in the context of this project.

## 4.4 Off gas Treatment

The technical-economic analysis, based on the forecast mass balance of the treatment, has shown that the treatment of gases extracted on activated carbon is the most economical solution, while allowing a significant reduction in the content of volatile pollutants.

The choice of SUEZ RR IWS REMEDIATION FRANCE fell on two parallel filtration lines, each of the lines being made up of three 200-liter activated carbon filters arranged in series (capacity of 75 kg of activated carbon per filter). When the activated carbons from the two drums placed at the head reached saturation, said drums were emptied, tipped at the end of their respective filtration line and then supplemented with healthy activated carbons. The soiled activated carbons were packaged in big bags. Each big-bag will be completed with 400 to 600 kg of activated carbon.

The VOC content in the air flow at the outlet of each drum has been measured to effectively control the gaseous discharge to the atmosphere and to avoid any exceeding of the discharge criteria.

## 4.5 Control parameters

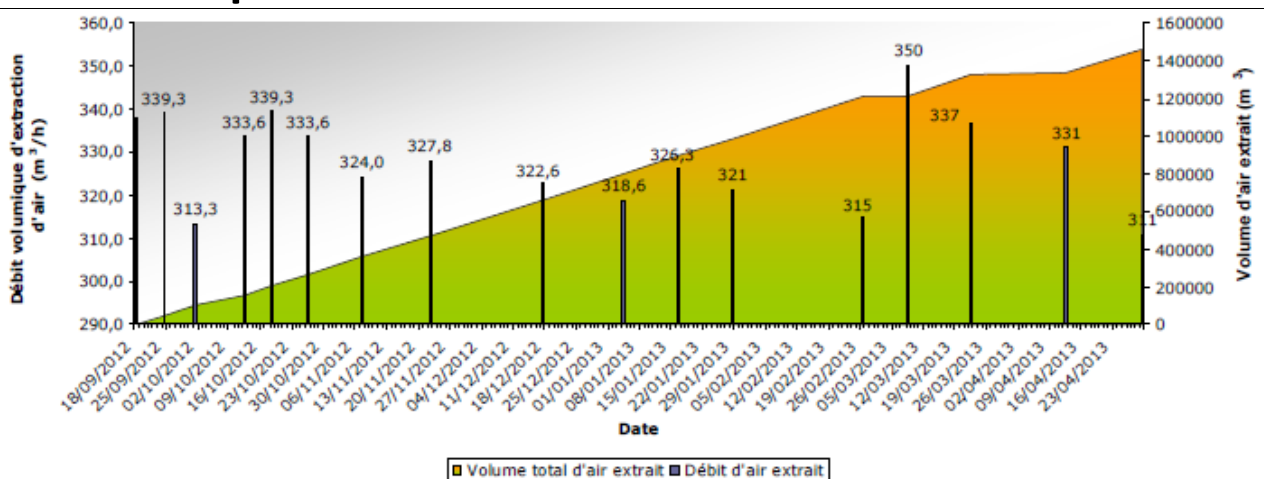

**Evolution of the extraction volume flow of the treatment unit and the total volume of air extracted from the ground**

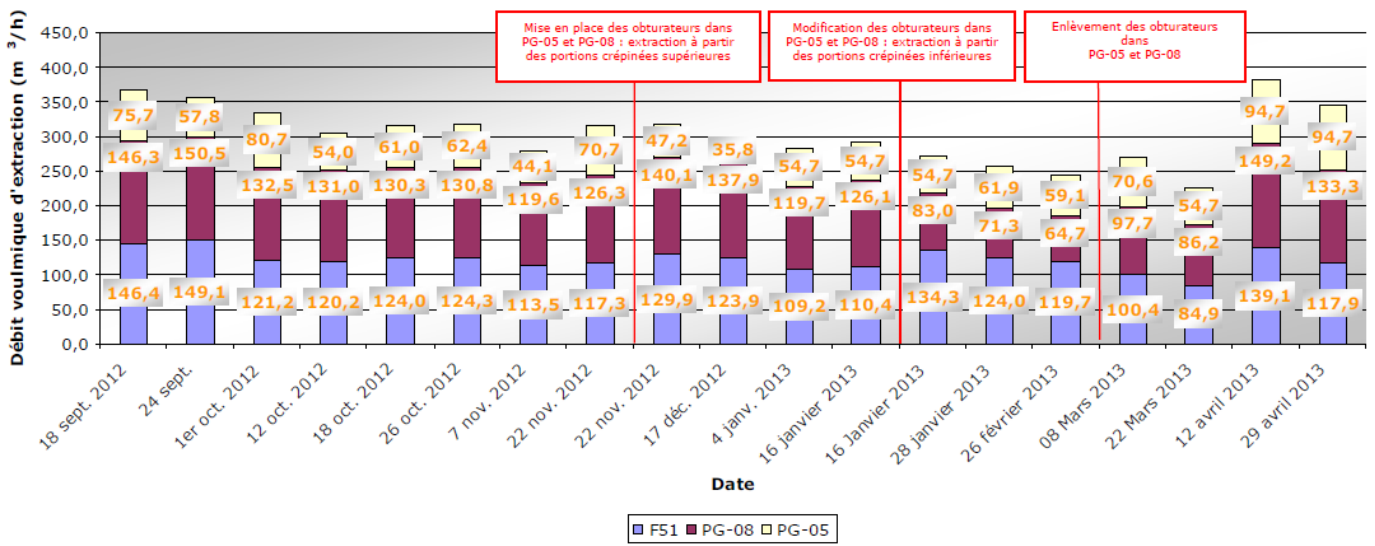

Evolution of the air extraction volume flow of each treatment well

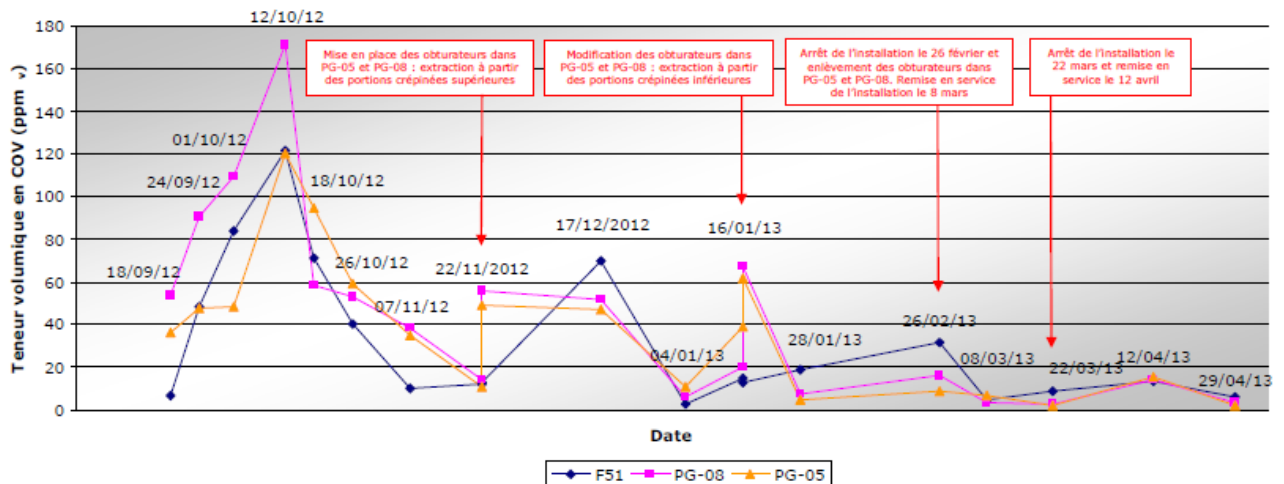

Evolution of the volume contents of VOCs in the air flow extracted from each treatment well

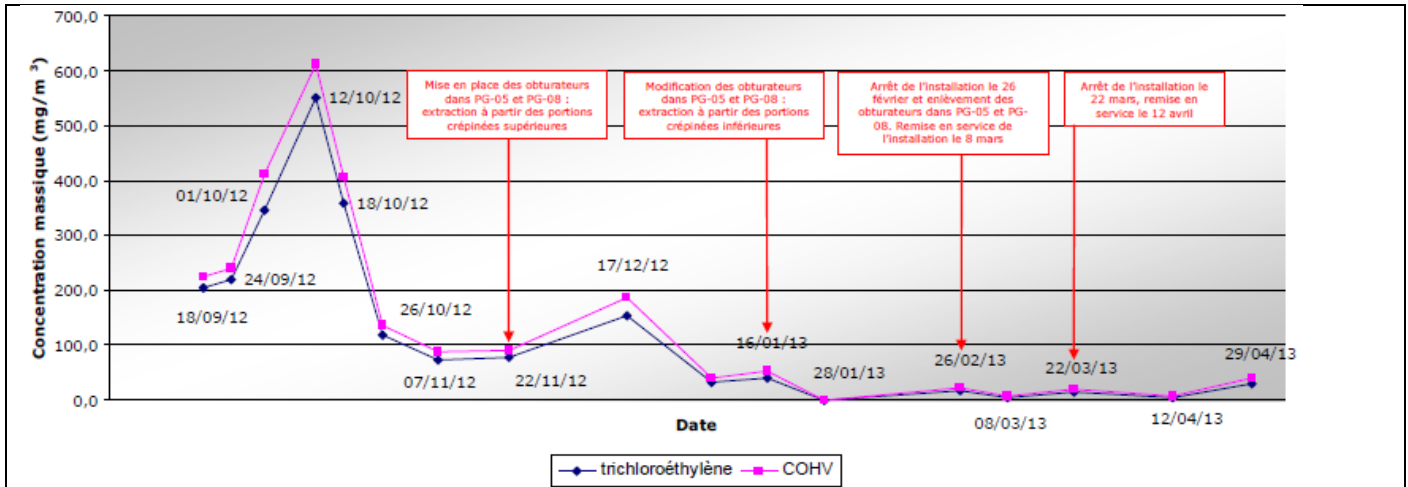

**Evolution of the mass content of trichlorethylene in the air flow extracted from the ground**

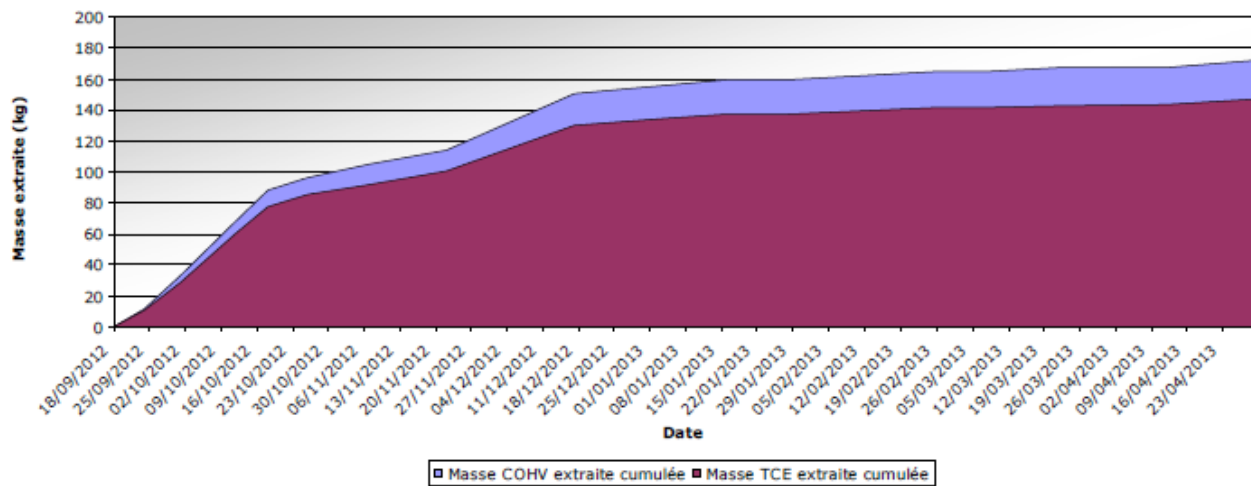

**Evolution of the masses of VOCs and TCE extracted from the ground by the soil vapor extraction treatment, according to analytical monitoring**



## 5. Enhancements to SVE

### 5.2 Any other enhancement

Apart from the use of shutters and specially designed well heads during treatment for the PG-05 and PG-08 wells (as a reminder, in order to carry out a selective extraction of gases from the soil in the Fontainebleau sands formation overlying or underlying the carbonate and clay horizon generally intersected between 14 and 16 m deep), SUEZ RR IWS REMEDIATION FRANCE has not implemented other improvements to the SVE system.

## 7. Additional information

### 7.1 Lesson learnt

Controlled project, without particular constraints to be met. The SVE treatment made it possible to achieve the asymptote of recovery of TCE in the horizon of the Fontainebleau sands. The client did not communicate to SUEZ RR IWS REMEDIATION FRANCE the analytical results from the groundwater monitoring but had nevertheless shared the information that the quality of the groundwater at the level of the piezometer located directly downstream of the treatment zone was improved.

## 1. Contact details - CASE STUDY: SVE n.10

<b>1.1 Name and Surname</b>	Simone De Fazio <sup>1</sup> – Corrado Thea <sup>2</sup>
<b>1.2 Country/Jurisdiction</b>	Italy
<b>1.3 Organisation</b>	Golder Associates S.r.l.
<b>1.4 Position</b>	<sup>1</sup> Geologist – <sup>2</sup> Environmental engineer
<b>1.5 Duties</b>	Italian Environmental laws (D.Lgs 152/06)
<b>1.6 Email address</b>	sdefazio@golder.it – cthea@golder.it
<b>1.7 Phone number</b>	+39 011 2344200

## 2. Site background

### 2.1 History of the site

The Site is an ex industrial plant operating from the '50s to 2009, when it has been re-located because the area has become almost completely residential.

The remediation procedure for the Site started at the beginning of the 2000s, because a facility downstream from the Site was found to be impacted by an incoming chlorinated solvents contamination. Since 2000 soil and groundwater were largely investigated and a remediation activity was performed from 2011 to 2013.

In 2017 pilot tests were undertaken in order to address the PCE contamination detected in soil and groundwater. The selected technologies are Enhanced Reductive Dechlorination for GW and SVE for soil. Due to good results achieved in pilot tests, a full scale remediation was performed at the beginning of 2019 and it's still ongoing.



Site Aerial map with monitoring wells



## 2.2 Geological setting

Site soil consists of gravel and sand, interbedded with thin layers of sandy silt. The depth to groundwater is approximately 20 meters below ground surface (bgs).









## 2.3 Contaminants of concern

The main contaminant is tetrachlorethylene (PCE), detected in soil and groundwater. Trichloroethylene (TCE), 1,2 dichlorethylene (1,2-DCE) and Vinyl chloride (VC) are also present, as PCE degradation products.

In soil PCE was detected in concentration of about 1000 mg/kg. PCE in soil gas was up to 4900 mg/m<sup>3</sup>.

The remediation target for the Site was calculated by a human health risk assessment and for the soil matrixes is a soil gas target (because of the vapour inhalation risk) and it is equal to 110 mg/m<sup>3</sup> for PCE, at the sub slab pins installed underneath the building and 2000 mg/m<sup>3</sup> at the soil gas probes installed outdoor.

## 2.4 Regulatory framework

The main environmental law in Italy is the Legislative Decree no. 152/2006 (D.Lgs 152/06) that in Part four, Title fifth sets specific rules for remediation of contaminated sites.

The reference legislation establishes some threshold values (CSC D.Lgs 152/06 and limits DM31/15) for the main contaminants both in soil and groundwater; if during the characterization there are one or more exceedance of threshold values, the site is defined "potentially contaminated", and a human health risk assessment can be developed to estimate the risks deriving from the potential sources of contamination detected on site (defined by the samples with exceedance) and to calculate risk-based site-specific threshold limits (CSR). The legislature also fixes which are the values of acceptable risk for the assessment.

If the estimated risks are lower than acceptable values, the site is defined "not contaminated", and no remediation is needed. If the estimated risks are higher than acceptable values, the site is defined "contaminated", and remediation is needed. The risk based site-specific threshold limits (CSR) are the remediation targets.



### 3. Pilot-scale application in field

#### 3.1 Extraction system

A SVE pilot test was performed in a not vertical well drilled with a 10° plunge (from vertical), up to 16.5 m bgs, right underneath the underground tank that were the primary contamination source; the screened interval is positioned from 8 m to 16.5 m bgs, to target the residual contamination below the source area as indicated by previous investigations.

The test was conducted connecting the well (SVEa) to a blower and then applying a vacuum on the extraction well. Vapor flow rate, vacuum and VOC, O<sub>2</sub>, CO<sub>2</sub> and CH<sub>4</sub> concentrations were measured in the extraction well and in 4 nearby soil gas probes. A stepped rate test and a constant rate test was conducted on the test well. In the stepped rate test, each step was carried out for 30 minutes, at increasing flow rates (70, 95, 124 and 164 m<sup>3</sup>/h). During the constant rate test the maximum flow rate (164 m<sup>3</sup>/h) was used for a longer time (300 minutes).

Vacuum and VOC, O<sub>2</sub>, CO<sub>2</sub> and CH<sub>4</sub> concentration measured in soil gas probes was used to assess the Radius of Influence (“ROI”) of the SVE.

#### 3.5 Control parameters

Vapor flow rate, vacuum and VOC, O<sub>2</sub>, CO<sub>2</sub> and CH<sub>4</sub> concentrations were measured in the extraction well and in 4 nearby soil gas probes during the test.

In the graph below the VOC measured during the constant rate test. 5000 ppm is the over range value of the field gas detector.

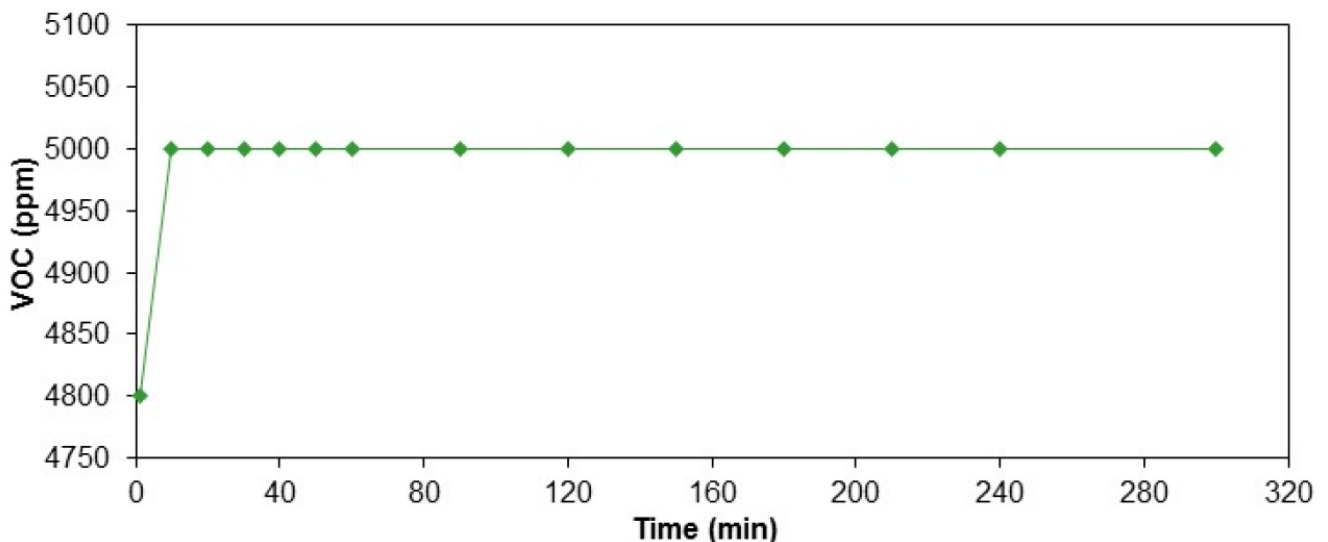



## 4. Full-scale application

### 4.1 Extraction system

The SVE system used included the following equipment:

- 1 non vertical well (SVEa), 3" in diameter, 16 m b.g.s. deep, 10° inclination;
- 3 vertical wells (SVEb÷SVEd), 3" in diameter, 9 m b.g.s. deep and located 12.5 m one from the other;
- 3 venting trenches, about 30 m long, located at 1 m bgs under the building basement floor and with a 7 m distance one from the other; each trench is composed by a HDPE pipe, screened, 4" in diameter, draining gravel, a protection sand layer and concrete;
- a blower and related vessels and piping, connected to a vapour treatment unit,
- vapour treatment unit composed of 3 Granular Activated Carbon ("GAC") filters.
- In addition, a HDPE vapour membrane was installed in the basement of the building to prevent subsoil vapour intrusion in the building basement and to increase the effectiveness of SVE action.

The schematic of the extraction venting trench is below.

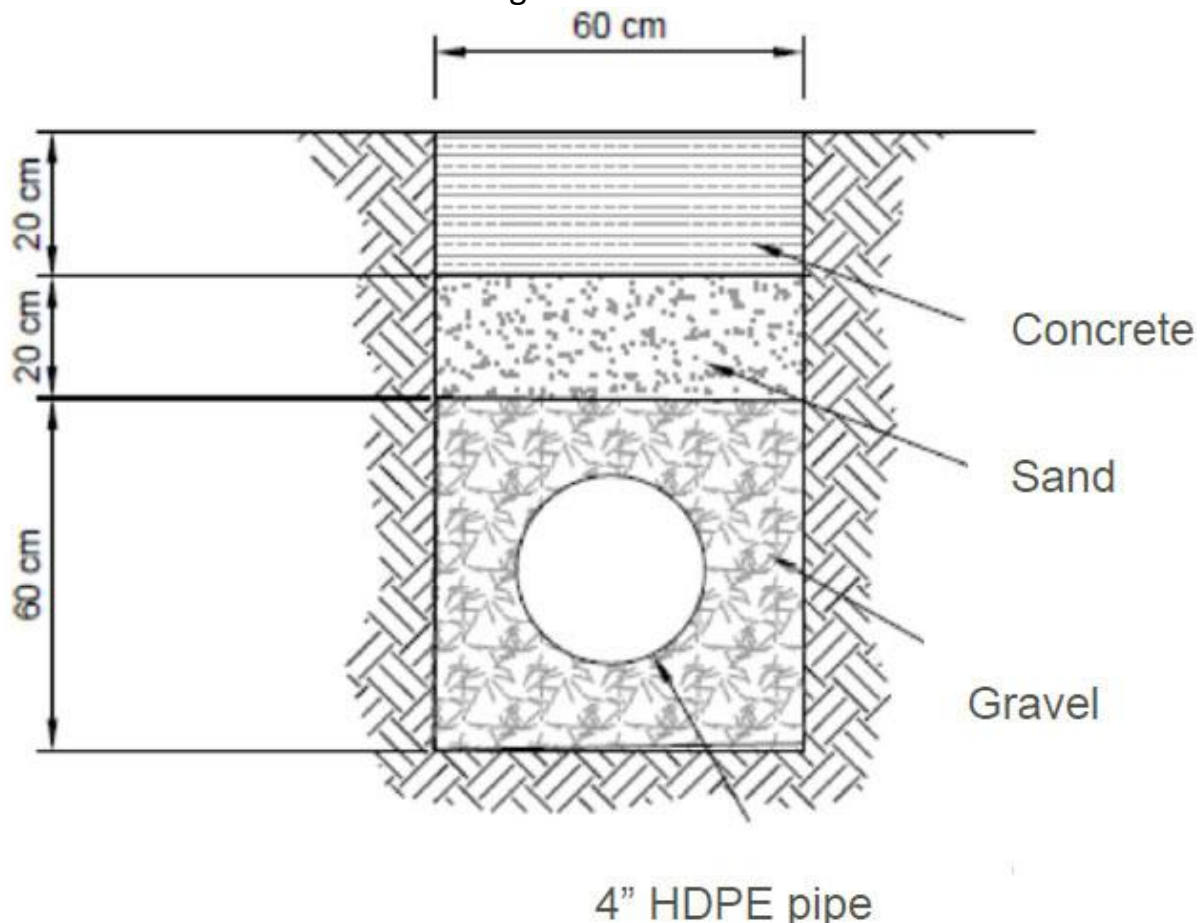

## 4.3 Radius of influence

Radius of influence (ROI) was calculated on the basis of induced vacuum and the pilot test results. The extracted flow is different for each extraction well in order to achieve the desired ROI: about 11-14 meters SVEa, about 7 meters SVEb-d.



## 4.4 Off gas Treatment

Activated carbon adsorption was used to remove all contaminants from the air stream; filters consist in 3 iron tanks, 150 cm high (270 cm with legs), 127 cm diameter, containing 800 kg of GAC each, connected in series.

The replacement of the GAC is scheduled based on the routine monitoring of VOC at the inlet and outlet of the system (see Chapter 4.5).

Off gas monthly monitoring at GAC filters outlet showed 0 ppm values over all the operational period, thus confirming the effectiveness of the off-gas treatment.





## 4.5 Control parameters

In addition, the SVE system has been equipped with a device that allows the continuous remote control of the operating parameters.

The PCE concentration decreased of 1 to 2 order of magnitude after 1 year of operation of the system and now is less than 10 ppm. Soil gas concentrations achieved remediation goal in all monitored soil gas probes.

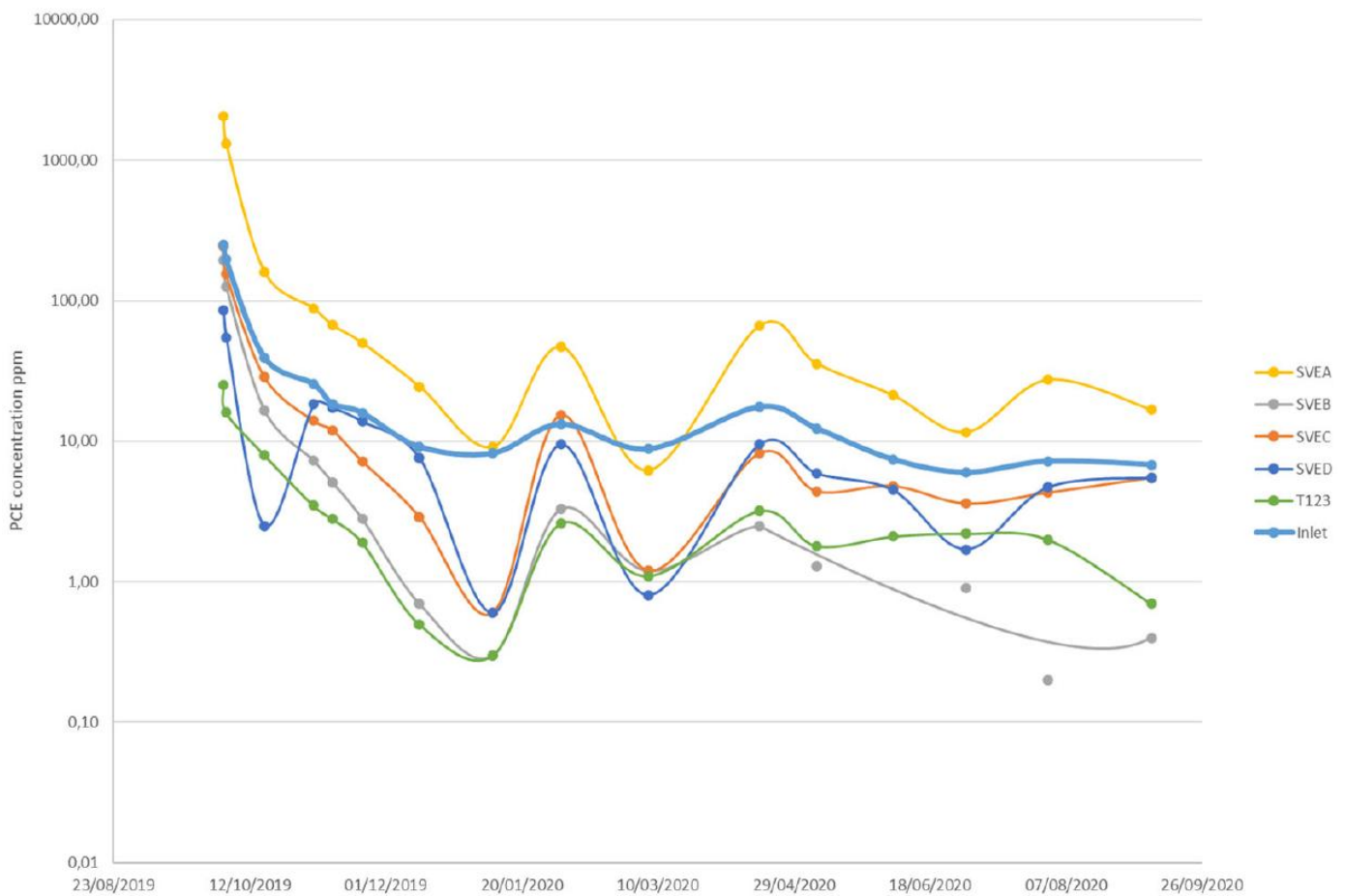



## 6. Post treatment and/or Long Term Monitoring

### 6.1 Post treatment and/or Long Term Monitoring

In compliance with the Remediation Plan, the SVE system was operated for 12 months up to asymptotic concentrations. After the shutdown of the system soil gas and sub slab sampling round was undertaken in order to verify the effectiveness of the SVE operation; further sampling campaigns are planned biannually for 2 years to confirm the reduction of the contaminants concentration in soil gas.

Results of the first soil gas and sub slab sampling undertaken after shutting down the SVE system showed concentrations below detection limits in all samples.

## 7. Additional information

### 7.1 Lesson learnt

During the remediation design it was invested in understanding deeply the Site Conceptual Model and in particular the secondary source; thus the remedial action targeted specifically and successfully the impacted source.

## 1. Contact details - CASE STUDY: SVE n.11

<b>1.1 Name and Surname</b>	Valentina Sammartino Calabrese
<b>1.2 Country/Jurisdiction</b>	Italy
<b>1.3 Organisation</b>	ARPA Campania
<b>1.4 Position</b>	Technical Collaborator
<b>1.5 Duties</b>	
<b>1.6 Email address</b>	
<b>1.7 Phone number</b>	

## 2. Site background

### 2.1 History of the site

The area is located on the eastern outskirts of the city of Naples, in an area characterized by a high population density and the presence of numerous industrial activities, most of which are abandoned. In particular, there are hydrocarbon management activities, dedicated almost exclusively to storage, as refining activities have now ceased, manufacturing industry, engineering, production of services. The area is located within the Eastern Naples SIN, established in 1998.

There is a protocol for the entire area of the SIN "Program agreement for groundwater remediation" which provides that the P.A. takes over the remediation of the groundwater in place of the responsible parties who adhere to it (once the health risk for workers is excluded).

There are also technical protocols for environmental characterization activities developed by the PA.

In the past, the site was annexed to a large fuel storage area, currently it carries out storage and sale of automotive fuels.



Immagini ©2020 Maxar Technologies, Dati cartografici ©2020 50 m



## 2.2 Geological setting

the stratigraphic structure of the area can be schematized as follows:

- from 0.0 to approx. 2.0 ÷ 3.0 m depth: heterogeneous fill soil, with sandy and gravelly granulometry
- from approx. 2.5 ÷ 3.0m at about 5.0m depth: sandy silt and silt, cohesive
- from 4.0 ÷ 5.0m to 12.0m depth: sand, subjected to a silty level

There is an exchange between the superficial and the deep aquifer with an active underground water circulation. The structure of the aquifer is very complex: the pyroclastic and sedimentary materials that constitute it present continuous granulometric variations both in the areal and vertical sense.

The consequence of the granulometric heterogeneity and the permeability characteristics of the soils present is the difficult identification of low permeability levels with sufficient continuity to divide the aquifer into several distinct layers. The pitch therefore tends to be typed in several levels, corresponding to coarse and variously interconnected materials, but always maintaining a unique character. The current subsidence, in most of the territory under examination, is less than 3-5 m from the ground level.

Contamination affects both the unsaturated and saturated phase of the subsoil.



## 2.3 Contaminants of concern

SOIL CONTAMINATION CONCENTRATIONS RANGE detected up to 6 meters deep from the ground level:

- Hydrocarbons C <12 400 mg/kg - 6500mg/kg
- Hydrocarbons C > 12 1300 mg/kg - 4600mg/kg
- Benzene 3 mg/kg - 118 mg/kg
- Ethylbenzene 100 mg/kg
- Total Xylenes 80 mg/kg - 400 mg/kg

RANGE OF CONCENTRATIONS CONTAMINATION OF GROUND WATER:

- TOTAL hydrocarbons 600 µg/l - 12000 µg/l
- Benzene 130 µg/l - 900 µg/l
- Toluene 17 µg/l - 2850 µg/l
- Ethylbenzene 100 µg/l - 330 µg/l
- Total xylenes 12 µg/l - 825 µg/l
- MTBE 50 µg/l - 6000 µg/l

## 2.4 Regulatory framework

D.Lgs. 152/2006



## 3. Pilot-scale application in field

### 3.1 Extraction system

Installation of an extraction well and a monitoring well both located within the contaminated area.

Execution of the test, with a portable system assembled for ventilation tests, consisting in:

- a Blower (aspirator) with flameproof execution side channels, being hydrocarbons, with a power of 3 KW, 50 Hz;
- a 200 L activated carbon filter for air;
- Mineral-based activated carbon for air drawn into cylinders with a high degree of activation of the type Chemviron Carbon 207E 4x8 US mesh.
- step test at different air extraction rates, for each of which the monitoring induced depression on wells, concentrations of VOC, CO<sub>2</sub> and O<sub>2</sub>, both through the wells monitoring, which exits the system.

The pilot test was conducted by inducing two different, corresponding depressions steps respectively at two different values of extracted air flow rates: the test began with a flow rate Q1 = 450 m<sup>3</sup>/h and subsequently continued with a flow rate Q2 = 350 m<sup>3</sup>/h.

### 3.3 Radius of influence

In order to calculate the radius of influence, the distance at which the vacuum is 10% of the vacuum applied to the extraction well is considered.

### 3.4 Off gas Treatment

a 200 L activated carbon filter for air: mineral-based activated carbon for air drawn into small cylinders with a high degree of activation of the Chemviron Carbon 207E 4x8 US mesh type.





### 3.5 Control parameters

A step test was carried out at different air extraction rates, for each of which the depression induced on the monitoring wells, the concentrations of VOC, CO<sub>2</sub> and O<sub>2</sub>, both through the monitoring wells, and at the outlet were evaluated. from the system.

The maximum concentration of polluting vapours extracted occurred in the first 30 minutes of the test, beyond which there was a drastic lowering of the same, up to values close to those of the natural subsoil.

With the decrease in extracted flow, a very modest increase in vapours in terms of VOC was observed, certainly not very significant.

The test was interrupted after about 8 hours due to the temporary exhaustion of the polluting load.

A good response of the system was instead obtained from the variation of the oxygen and carbon dioxide levels, which caused a decrease in O<sub>2</sub> and an increase in CO<sub>2</sub>. This data indicates a modest but continuous presence and action of indigenous microorganisms, which oxidize organic substances by consuming oxygen and producing water and carbon dioxide.

From the calculations carried out it was possible to evaluate the optimal operating flow rate equal to approximately  $Q = 400 \text{ m}^3/\text{h}$ , with a radius of influence for each ventilation shaft equal to approximately 12 m.



## 4. Full-scale application

### 4.1 Extraction system

The air extraction system (EVS) has provided for n. 3 ventilation shafts of 2 "pushed up to a depth of 3 m, and made up as described below:

- Blower (aspirator) with explosion-proof side channels (being hydrocarbons) with a power of 5.5 KW.
- "water trap" (for condensation of the extracted vapours);
- 200 litres active carbon filter for air;
- n. 3 gate valves to regulate flows and capacities;
- vacuum gauges with scales from 0 to 100 mbar and from 0 to 1000 mbar;
- PVC pipes with high decompression resistance;
- wellhead that can be inspected, with quick couplings, for measuring the gases and depressions induced on each ventilation shaft;
- connection to the blower of the wells with pipes of adequate diameter;
- all the pipes have been conveyed into a regulation barrel with valves for regulating the flows
- dilution valve before entering the blower.

### 4.3 Radius of influence

In order to calculate the radius of influence, the distance at which the vacuum is 10% of the vacuum applied to the extraction well is considered.



## 4.4 Off gas Treatment

The vapour treatment system (VOC) includes n. 1 filter containing activated carbon for air based on mineral drawn in cylinders with high degree of activation of the Chemviron Carbon 207E 4x8 US mesh type.

Below is a description with the characteristics of the activated carbon:

- Activation process = Steam;
- Density = 0.46 g/cc;
- Compacted material density = 0.50 g/cc;
- Packaging humidity = 3% by weight;
- Total specific surface (BET method) = 1100 m<sup>2</sup>/g;
- Ash content = 8% by weight;
- Hardness = 97%;
- Iodine index = 1000 mg/g;
- Carbon tetrachloride index = 60% by weight;
- Benzene index = 35% by weight;

the average concentration of volatile organic substances to be removed is about 1g/m<sup>3</sup>; the plant has a capacity of 400 m<sup>3</sup>/h, the total amount of volatile organic substances to be removed is about 400 g/h per hour. Every 100 kg of carbon have an adsorbing power of about 10 kg of organic substance. The abatement system, therefore, consisting of a 600 kg battery of activated carbon, has an autonomy of about 2 months.

## 4.5 Control parameters

<i>Control</i>	<i>Frequency</i>	<i>Parameters</i>	<i>Point of monitoring</i>
<i>Startup (7-10 days)</i>	<i>daily</i>	<i>Flow</i> <i>Extraction pressure</i> <i>Steam concentration</i>	<i>Extraction well</i> <i>Pipeing</i> <i>Emission</i>
<i>After startup</i>	<i>Every 2 weeks</i>	<i>Flow</i> <i>Extraction pressure</i> <i>Steam concentration</i>	<i>Extraction well</i> <i>Pipeing</i> <i>Emission</i>



## 6. Post treatment and/or Long Term Monitoring

### 6.1 Post treatment and/or Long Term Monitoring

In order to verify the dynamics of the remediation process and the proper functioning of the installed system, monitoring/maintenance visits are scheduled on a monthly basis, including the following works:

- General maintenance of plants and calibration of installed systems;
- Replacement and disposal, when necessary, of spent activated carbon;
- Measurement of VOC, CO<sub>2</sub> and O<sub>2</sub> leaving the ventilation system and regulation of induced depressions;
- Sampling of the incoming and outgoing air from the abatement system. Organic substances are analyzed on a quarterly basis for the entire duration of the remediation. The data is developed and processed using specialized software.

Monitoring of the soil gas, after a three-month stop of the EVS, to implement a new risk analysis three years after the start of treatment.

volatile organic substances analyzed: Benzene - Toluene - Ethylbenzene - Xylenes (BTEX), MTBE and total hydrocarbons.

Samples are taken by means of a low flow pump and adsorption on activated carbon vials

## 7. Additional information

### 7.1 Lesson learnt

In case of contamination even of the saturated one, a technology that is effective for both matrices (unsaturated and saturated) is preferable

## 1. Contact details - CASE STUDY: SVE n.12

<b>1.1 Name and Surname</b>	Daniela Fiaccavento
<b>1.2 Country/Jurisdiction</b>	ITALY-VENETO
<b>1.3 Organisation</b>	ARPAV
<b>1.4 Position</b>	Public servant, expertise in soil remediation
<b>1.5 Duties</b>	Evaluation site characterization and remediation projects
<b>1.6 Email address</b>	<a href="mailto:daniela.fiaccavento@arpa.veneto.it">daniela.fiaccavento@arpa.veneto.it</a>
<b>1.7 Phone number</b>	+39 0422 558504

## 2. Site background

### 2.1 History of the site

In July 2011, due to a road accident between a little van and a petrol tanker, 8 m<sup>3</sup> of unleaded gasoline spilled onto the road, affecting neighbouring land and some stretches of moats adjacent to the road

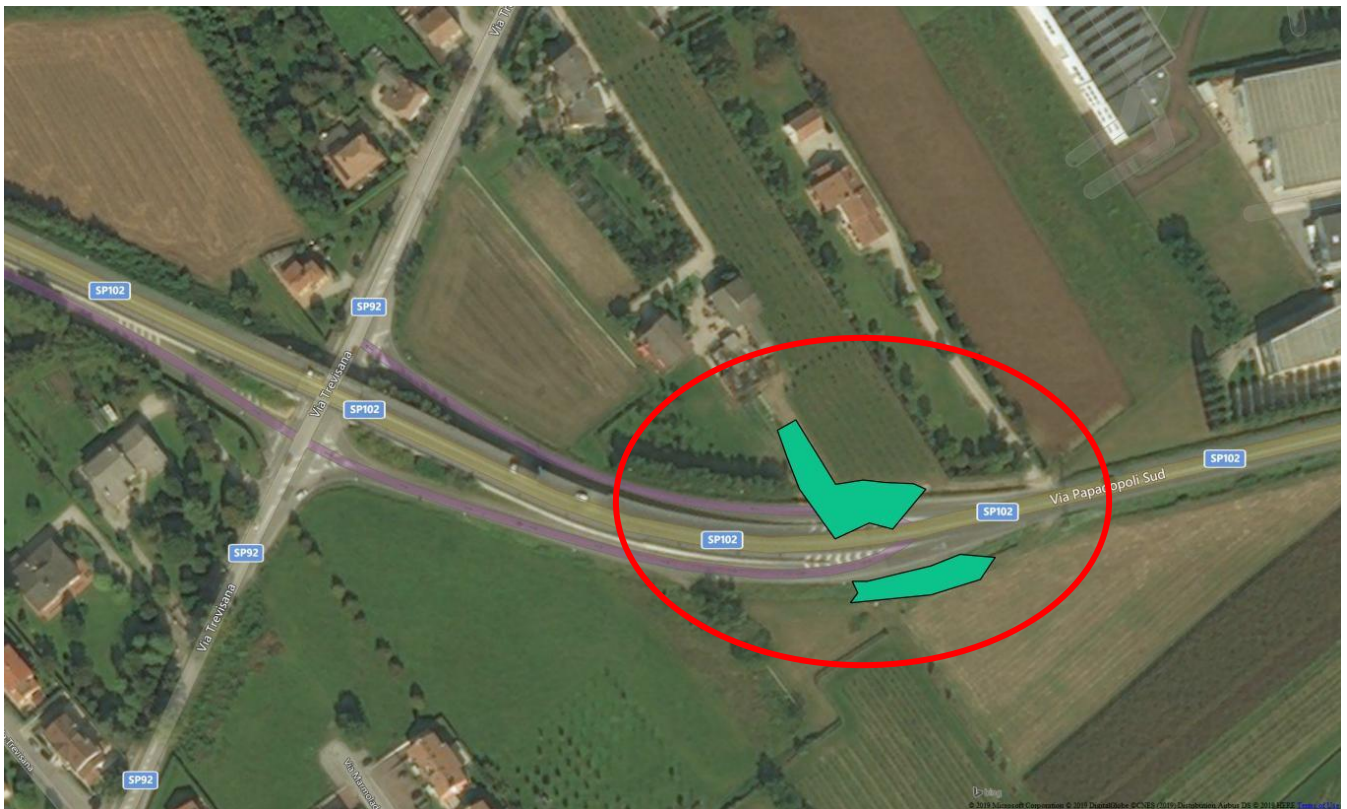





## 2.2 Geological setting

Under the first 20 centimeters of topsoil, the site presents 2/3 meters of alternation of sandy silts and silty sand and then, till 8 meters depth, fine and medium gravels in a sandy matrix.

The depth to ground water is approximately 2.5/3.0 meters below ground surface.

Below is reported the Shepard Diagram in which is collocated the types of soil of three surveys at different depth.

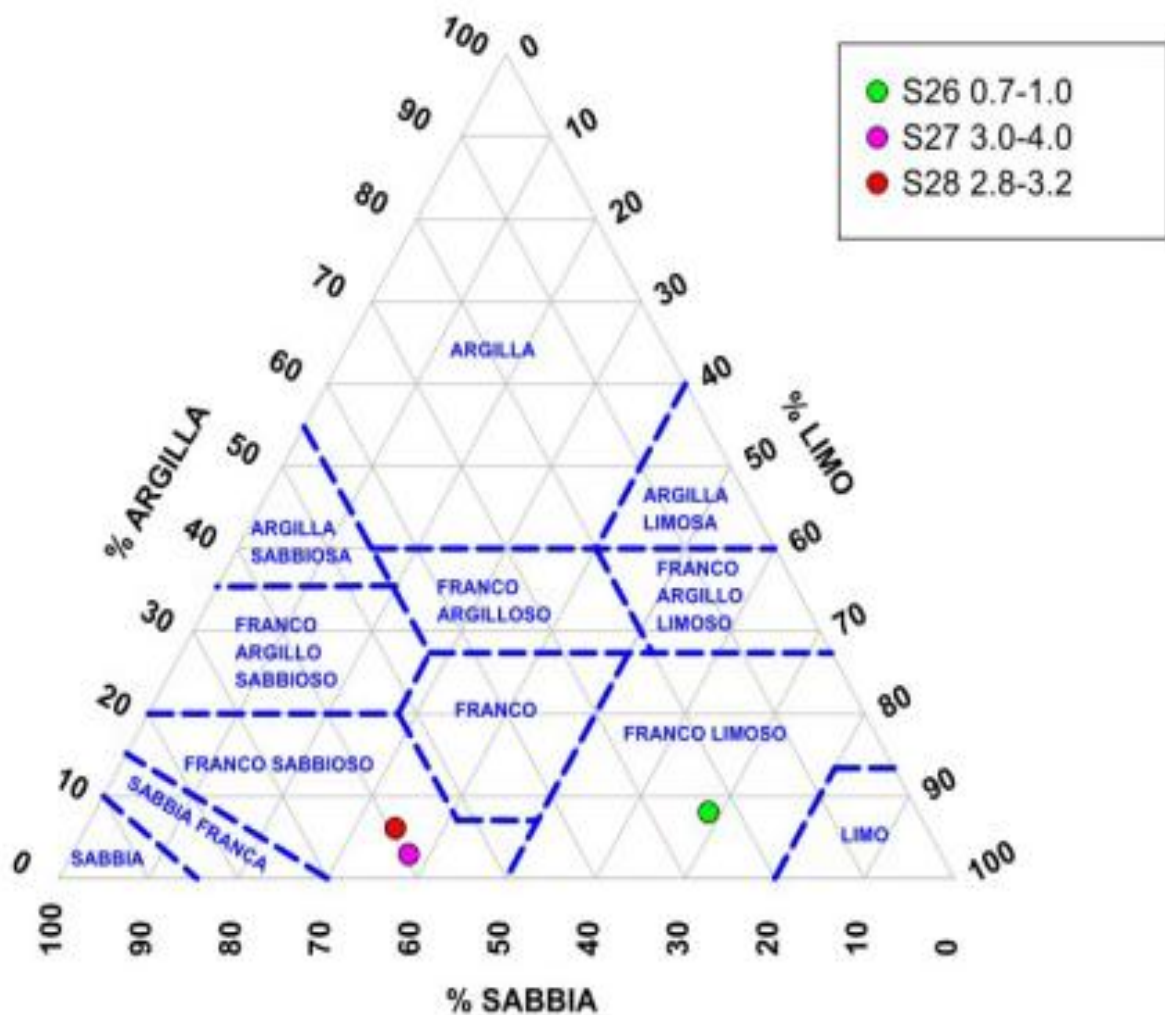

Shepard Diagram

In the figure below is reported a stratigraphy of a soil survey.

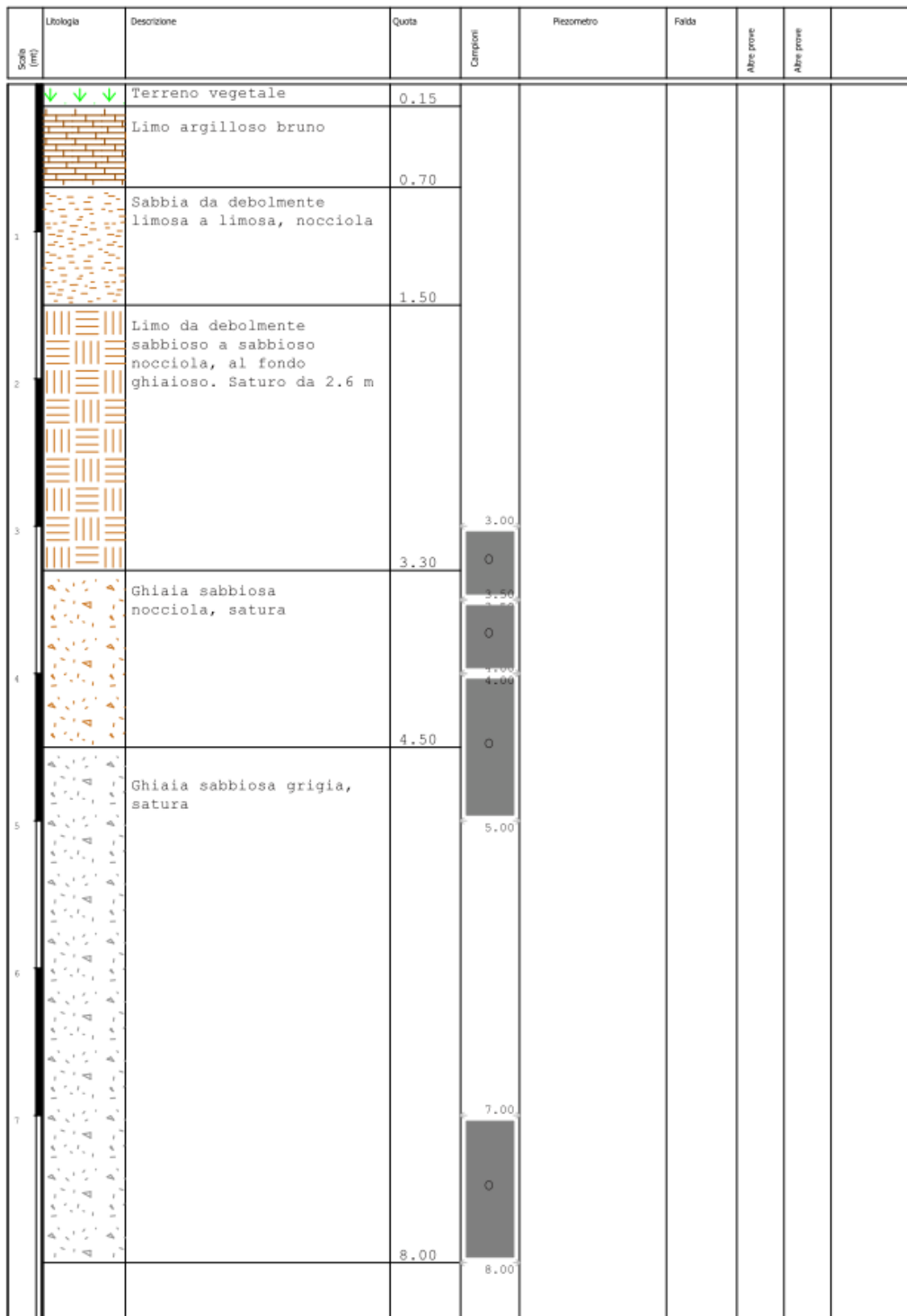

## 2.3 Contaminants of concern

Organic Compounds typical of unleaded petrol: benzene, ethylbenzene, toluene, xylene, styrene, MtBE ( methylterbutyl ether), also measured in soil gas sampling from well realized in to the subsoil.

In Italy is defined as contaminant also light hydrocarbons (C<12) and heavy Hydrocarbons (C>12), which is specified according to MADEP Method (Aliphatics C5-C8, Aliphatics C9-C12, Aromatics C9-C10 and Aromatics C11-C12 for light Hydrocarbons and Alifatics C13-C18, Alifatics C19-C36 and Aromatics C13-C22 for heavy Hydrocarbons).

In the two tables below are reported The maximum concentration, in mg/kg, for each contaminants of concern, in the surface soil (0÷1 meter deep) and in the subsoil (under 1 meter deep).

*Table 1. Max Concentration in surface soil for each CoC*

Benzene	Etilbenzene	Stirene	Toluene	Xileni	MTBE	C<12	C>12	CTOT C<>12	ALIFATICI C5-C8	ALIFATICI C9-C18	ALIFATICI C19-C36	AROMATICI C9-C10	AROMATICI C11-C22
8,1	71,0	2,3	169,0	590,0	28,0	3150,0	422,0	3180,3	1619,1	105,5	145,7	1087,7	0,0

*Table 2. Max Concentration in subsoil for each CoC*

Benzene	Etilbenzene	Stirene	Toluene	Xileni	MTBE	C<12	C>12	CTOT C<>12	ALIFATICI C5-C8	ALIFATICI C9-C18	ALIFATICI C19-C36	AROMATICI C9-C10	AROMATICI C11-C22
14,5	44,1	-	352	519	31,9	4980	37,6	5010,6	3921,4	17,5	29,8	1041,6	0,20



## 2.4 Regulatory framework

The Italian law provides for remediation of contaminated sites specific targets for urban soil and subsoil, for each contaminants of concern (CSC col. A tab. 1 All. 5 Parte Quarta Titolo V del D. Lgs. n. 152/06).

With the application of a site based risk analysis, whose results have been reported by the company in the specific document approved by the responsible Institution, it has been defined new target levels for soil.

It has been defined target concentrations for each contaminants also in soil gas, to evaluate the performance of the Soil Vapor Extraction plant.

## 3. Pilot-scale application in field

It wasn't realized a pilot scale application before the full scale plant.

Pilot test were realized after the installation of the full scale plant, before its full operation.

## 4. Full-scale application

### 4.1 Extraction system

Because of the fact that the ground water was positioned from 2.5 to 3.5 meters of depth, the project of SVE was based on a system of horizontal wells, like in the two figures above.

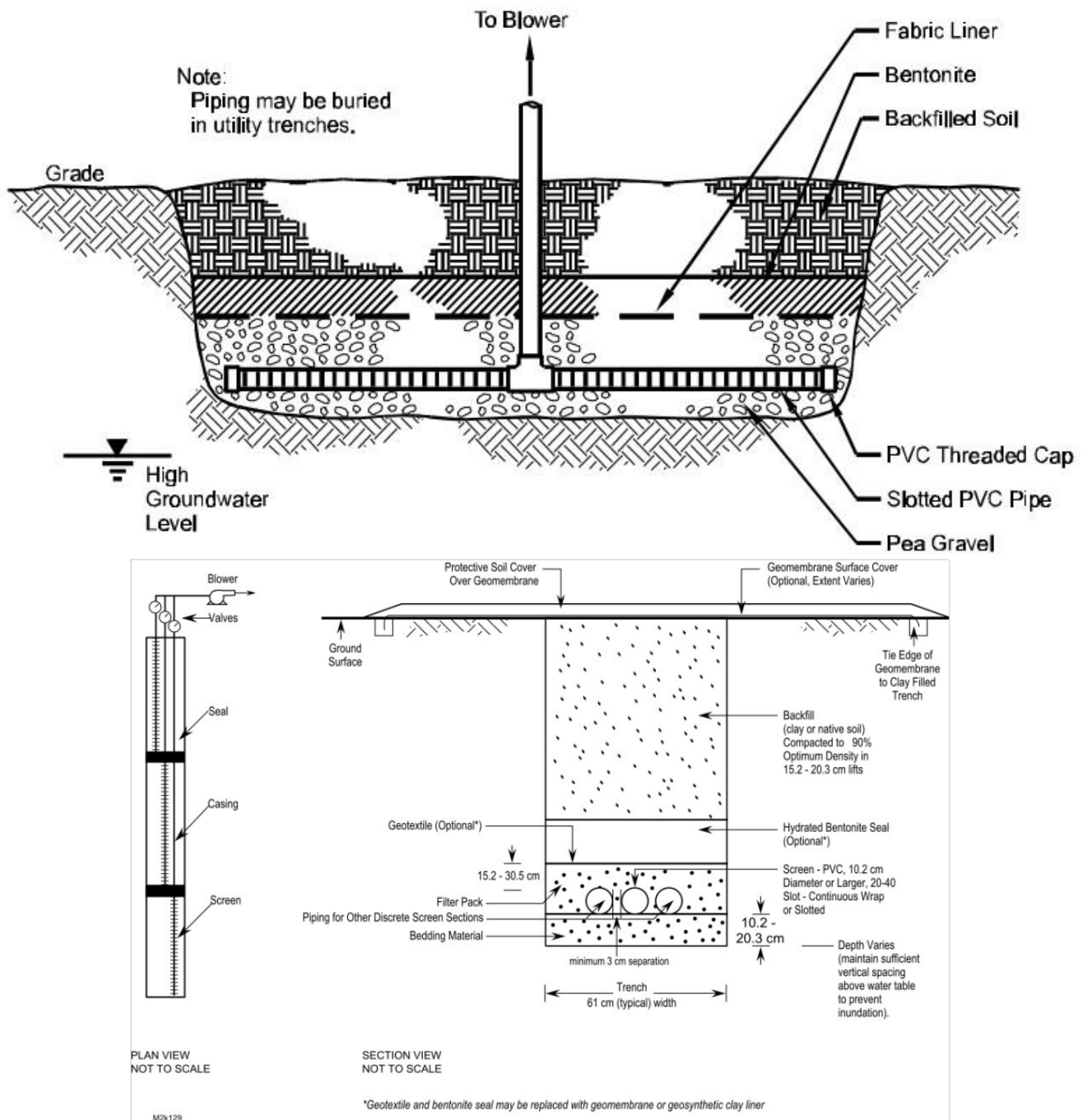

Typical construction scheme of an horizontal extraction well, view in plan and in section

(from U.S. Army Corps of Engineers, 2002)

Two horizontal lines were been made, one parallel to the road (line 1), the other orthogonal the road, forward the house (line 2), as shown in the next figure.

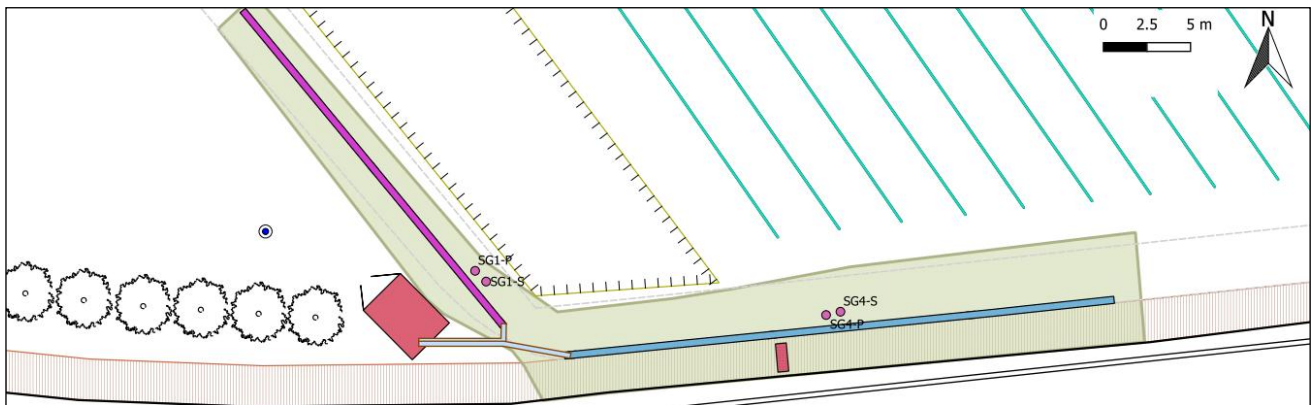

In the following table are reported the technical characteristics of the two lines of SVE

	Line 1			Line 2	
width	0.4m			0.4m	
depth	1.1m			1.3m	
length	38m			26m	
Number of sections/extraction wells	3			2	
Denomination of wells	SVE L1A	SVE L1B	SVE L1C	SVE L2A	SVE L2B
Blind section	1m	12m	24m	1m	12m
Screened section	12m	12m	12m	12m	12m

In the figure below is reported the plant scheme, which represents both extraction lines and the off-gas treatment system.

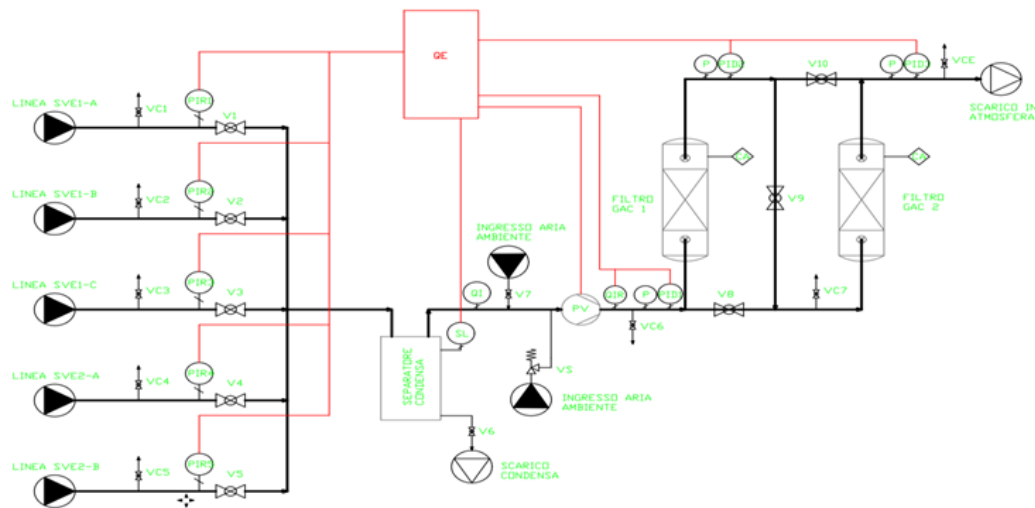

SIMBOLI	DESCRIZIONE
QE	QUADRO ELETTRICO DI ALIMENTAZIONE CONTROLLO E CAMPIONAMENTO VOC ALIMENTATO DA LINEA ELETTRICA ESTERNA.
FILTRO GAC1 E 2	COLONNA A RIEMPIMENTO CON CARBONE ATTIVO GRANULARE PER ARIA
PV	POMPA A VUOTO O ASPIRATORE
VCI - 7	RUBINETTO CAMPIONAMENTO GAS
VCE	RUBINETTO CAMPIONAMENTO EMISSIONI IN ATMOSFERA
V1 - 10	VALVOLE DI INTERCETTAZIONE
VS	VALVOIA DI SICUREZZA
PIR1-5	MANOMETRO INDICATORE E REGISTRATORE CHE INVIA IL SEGNALE ELETTRICO AL QUADRO QE
P	MANOMETRI INDICATORI
SL	SENSORE DI LIVELLO ACQUA NEL SEPARATORE DI CONDENZA CHE INVIA IL SEGNALE ELETTRICO AL QUADRO QE
QI	FLUSSIMETRI INDICATORE
QIR	FLUSSOSTATO INDICATORE E REGISTRATORE CHE INVIA IL SEGNALE ELETTRICO AL QUADRO QE
PID1 - 2	PUNTI DI PRELIEVO GAS PER SENSORE PID POSIZIONATO NEL QUADRO QE
CA	PUNTO DI CARICO CARBONI ATTIVI

Once extracted, the contaminated vapor was dealt to a treatment unit, based on activated carbon adsorption (see the section “off-gas treatment”)

After the beginning test (explained in the following section) SVE system started in January 2018 and was stopped before soil testing, performed in March 2019, even if the target in soil gas concentrations had already been reached in September 2018.



## 4.3 Radius of influence

The radius of influence were verified directly during the functioning of the plant through the measurement of the depression induced at the edge of the site.

The field test was realized in the following way:

1. installation of high sensitivity differential pressure sensors ( $\pm 300$  Pa) in three monitoring wells (located like in the following figure) and reset of the instrument (zero adjusted - 0 Pascal);
2. recording of basic value;
3. pump start with all 5 extraction lines open;
4. continuous recording of flow rate and depression values

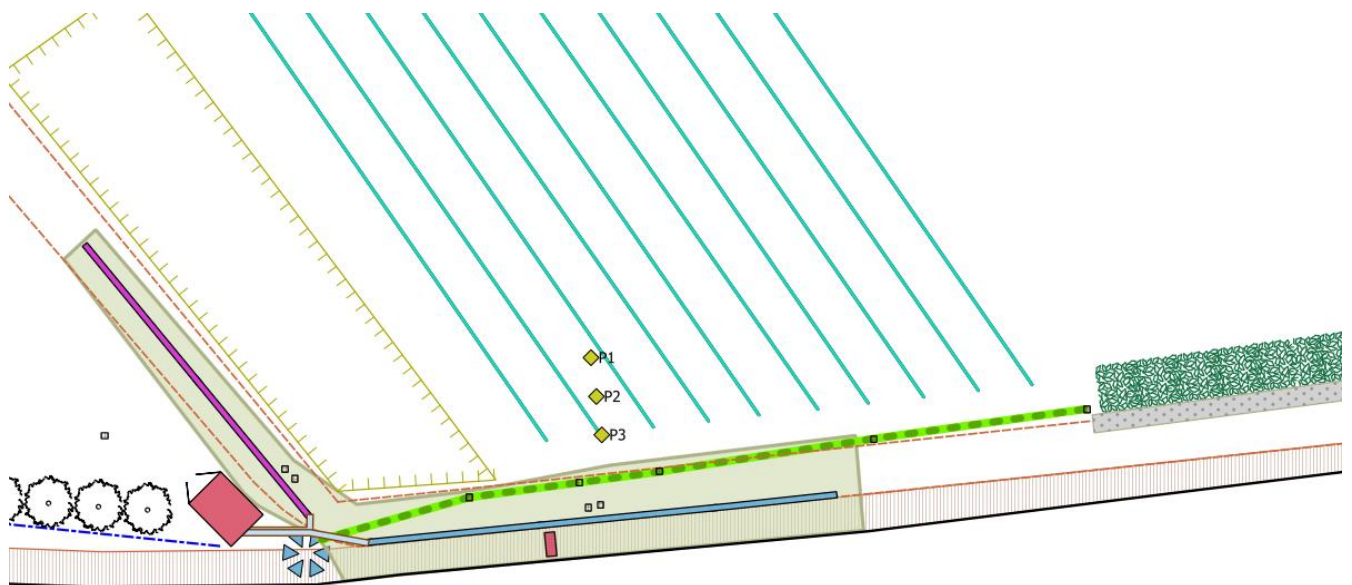

Location of pilot test wells

It was measured an appreciable induced depression, with a calculated radius of influence (6.5 m and 8.4 m) that in both cases exceeded the intervention distance, equal to 3-4 m, from the axis of extraction lines.



## 4.4 Off gas Treatment

The vapor treatment unit consists of an activated carbon unit of two modules with a capacity of 250 kg each arranged in series. The details of each module are shown below.

length plates	1.6 m
area plates	1.2 square meter
Air flow	100 mc/h
Air velocity in the filter	1.4 m/s
Contact time	1.2 s

The activated carbon will be of mineral origin, physically activated with steam. Such materials are suitable for air flows with concentrations of about 2000 ppm and have an adsorption yield of about 10%.

Yield of carbon absorption	10%
Amount of coals needed	25,600 kg
Carbon consumption rate	5.5 kg/h
Carbon filter (2+250kg)	500kg
Filter charge duration	3.8 days

In the case in point, the project data to evaluate the duration of the filters is summed below.

Media soil gas concentration	2,500 mg/mc
Extraction flow	100 mc/h
Contaminant flow	0.25 kg/h
Total amount of contaminant to be removed	1,048 kg
Filter charge duration	80 days

To achieve the target of remediation, it has been used around 2,000 kg of activated carbon.

## 4.5 Control parameters

In order to continuously monitor emissions within the legal limits provided, it has been installed a continuous control system for the measurement of VOC at the effluent discharge through a PID.

To assess the progress of the remediation, soil vapour samples were collected from four soil gas wells, located near the soil vapour extraction line; the wells were realized in couple, two surface wells (up 1 meter deep) and two wells to monitoring soil gas in the subsoil (up to 2.5 meters deep)

The following figure shows the concentrations in the wells before starting of SVE and after some months of its functioning. The concentrations are also referred to the target concentrations defined through risk based analysis (“CSR” in the figure).

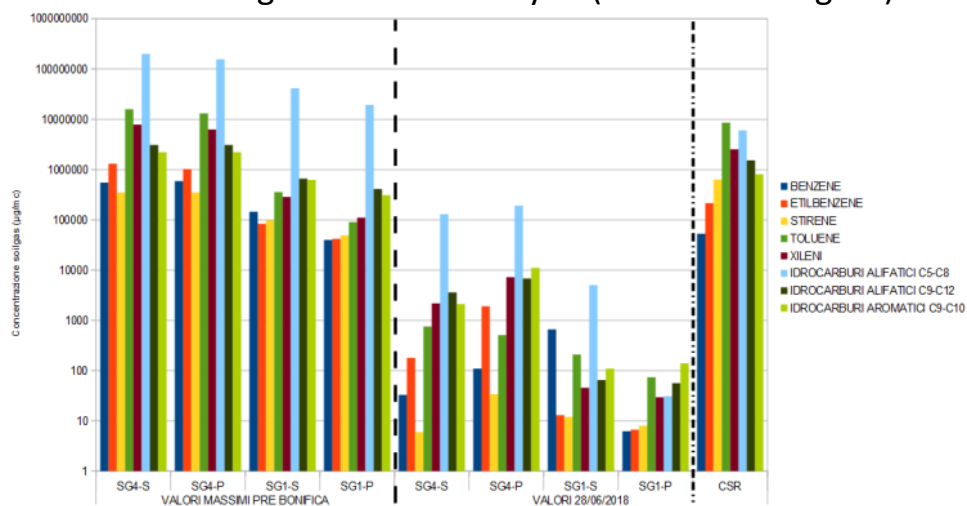

To collect soil gas sample were used stell canister or glasses bottle-vacuum (0.5 or 1 liter) with flow reduction to 50 ml/min. The soil gas chemical analysis were leaded with the MassDEP-APH 2009 method.





## 6. Post treatment and/or Long Term Monitoring

### 6.1 Post treatment and/or Long Term Monitoring

In 2018 we led two campaigns of monitoring soil gases from wells, in both cases after turning off the plant to evaluate a possible rebound effect.

Once the achievement of the soil gas target concentration had been verified, test activities on the soils were carried out, realizing four soil probes 5 meters deep. In each sample (five for each probe) it has been verified the achievement of the legal limits for each contaminant of concern.

After this test two other soil gas investigation campaigns were carried out, to confirm that the soil gas targets (concentration limits) have been reached.

## 7. Additional information

### 7.1 Lesson learnt

The case study described in this work was the first case in which it has been used a SVE extraction in fine soil (like sandy loam) and with a groundwater near the surface.

So, we found ourselves evaluating another plant solution, compared to other cases, with horizontal wells instead of the “classic” vertical wells.

In addition, unlike what the current legislation provided, reference soil gas concentrations were defined through risk analysis with the aim of assessing the progress of the remediation system.

### 7.3 Training need

I think that it would be very important to create and maintain a continuous training, not only with webinars and workshops, but also with creation of technical guidelines, and almost with training on-the job and sharing experiences with technicians from other organizations.

## 7.4 Additional remarks

In this paragraph I describe the experimentation performed in June 2017 to monitor the trend of concentration of contaminants in soil gas. This experimentation wasn't directly connected with the functioning of SVE, but it was carried out to collect more informations about the behaviour of soil gas during a certain observation period.

Going into specifics, the purpose of the experiments was:

- Evaluation of the comparability of different measurement methods
- Evaluation of the temporal variations on a sub-hourly scale of the Cov concentrations in the aeriform matrices
- Evaluation of the relationships and possible differences between surface probe and deep probe
- Possible indications of the possible perturbations induced by the sampling to the state of motion soil gas.

At the first, a high sampling frequency PID was installed in the deep probe, while the pressure differential trend was monitored in the surface probe.

A second Pid, identical to the first, was also installed for the measurement of volatile compounds in a free atmosphere. During this period, two campaign of soil gas samples were carried out, both with vacuum bottle and with dynamic flux chamber (in the figure below).



In the same period it has been installed a micrometeo control unit composed by a:



triaxial ultrasonic anemometer;

- rain gauge;
- thermohygrometer;
- differential pressure sensors

Continuous field measurements and laboratory analyzes of soil gases showed daily variability in concentrations; in addition, if the measurements are made at times favourable to the accumulation of contaminant, the detected concentrations will be higher than at other times of the day.

More details and explanation can be found at the following link

[https://www.arpae.it/dettaglio\\_documento.asp?id=7277&idlivello=1171](https://www.arpae.it/dettaglio_documento.asp?id=7277&idlivello=1171)

These experiments were carried out thanks to Copernico srl (UD), [www.copernicon.it](http://www.copernicon.it) the consulting company in the field of remediation of contaminated sites that followed the remediation activities from characterization to testing. The

images, graphics and tables shown in the present questionnaire are taken from the project documents drafted by Copernico.



## 1. Contact details - CASE STUDY: SVE n.13

<b>1.1 Name and Surname</b>	Aldo Trezzi
<b>1.2 Country/Jurisdiction</b>	Italy
<b>1.3 Organisation</b>	Ramboll Italy S.r.l.
<b>1.4 Position</b>	Principal
<b>1.5 Duties</b>	Aldo has more than 25 years of experience in the management of projects related to water treatment, soil and groundwater characterization and remediation of complex sites
<b>1.6 Email address</b>	<a href="mailto:atrezzi@ramboll.com">atrezzi@ramboll.com</a>
<b>1.7 Phone number</b>	+39-335 423725





## 2. Site background

### 2.1 History of the site

Large Industrial Chemical site (more than 100 ha) active since 1901.

Actual main production: Fluorinated Compounds

Historical productions involved large use of CrVI and CHCs, mainly Chloromethanes.

The area of interest for the application of the SVE system is about 7,000 m<sup>2</sup> and is impacted by mainly Chloromethanes both in the vadose zone and in the saturated zone.

## 2.2 Geological setting

From 0 to 1-2 m bgl typically is present filling material.

From 1-2 m bgl to 18-20 m bgl the soil consists mainly of gravel with sand and silt.

The depth to ground water is approximately 9 m bgl.

The following images show the geological setting from 0 to 10 m bgl.





## 2.3 Contaminants of concern

The main compounds of concern are:

- Tetrachloromethane
- Trichloromethane
- Trichlorofluoromethane

Max concentration detected in unsaturated soil:

- Trichloromethane: 23.00 mg/kg

Regarding the unsaturated soil, the only VOC detected in the area was the Trichloromethane, with a concentration of 8.9 mg/kg in the first meter b.g.l., 6.7 mg/kg between 2 and 3 meter b.g.l. and 23 mg/kg between 4.5 and 5.5 meter b.g.l.. Italian law threshold concentration value (CSC) for Trichloromethane is 5 mg/kg, and also the risk concentration value (CSR) defined by the risk analysis for Trichloromethane is 5 mg/kg.

Max concentration detected in the groundwater (2009-2012):

- Tetrachloromethane : 170,000 µg/l
- Trichloromethane: 290,000 µg/l
- Trichlorofluoromethane: 10,000 µg/l

## 2.4 Regulatory framework

Clean-up goals for soil and groundwater were defined in the Risk Assessment, and are included in the on-going remedial plan, approved in 2012. According to Italian regulation, although the remedial targets are defined on a Risk Assessment basis inside the facility (SSTLs or CSR), groundwater quality at the end of remedial action must comply with regulatory limits (CSC, much more conservative than calculated SSTLs) at the downgradient boundary of the site. Therefore, once reduced the concentration below the CSR for inhalation risk inside the facility, the ultimate clean-up goal for groundwater is to reduce and control the off-site migration.

Nonetheless, scope of the SVE system is to remediate the unsaturated soil: reduce as much as technically possible the presence of VOCs in the soil gas and obtain concentration of the VOC compounds in the soil below the calculated risk concentrations (< CSR).

Other technologies have been applied to remediate the saturated zone.

## 3. Pilot-scale application in field

### 3.1 Extraction system

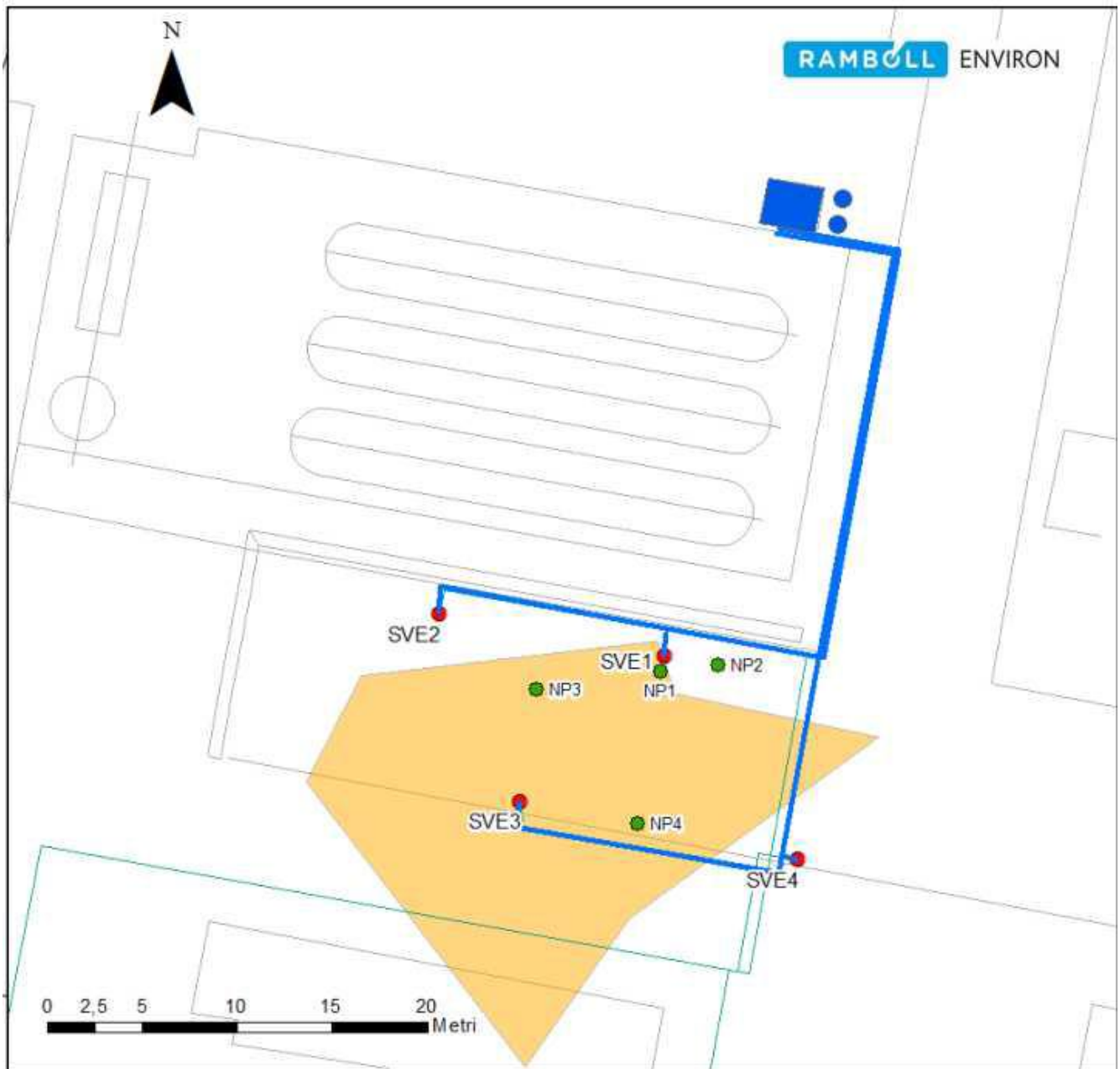

Before the installation of the full scale system, a pilot scale application was performed to estimate the effective Radius of Influence (ROI) of each extraction well, operating Flow Rate & Vacuum per each extraction point. The test system consisted in #4 SVE points (screened from 1 to 9 m bgl), # 4 Nests Probe Points (each equipped with #4 NP located



at different depths), #1 vapour/water separator tank, #2 air blowers connected in parallel (Each blower: 350 mc/h @  $\Delta P$  150÷175 mbar); #2 granular activated carbon filters connected in series (1,300 litres each) in order to remove the VOC from the vapour stream before the emission in atmosphere.

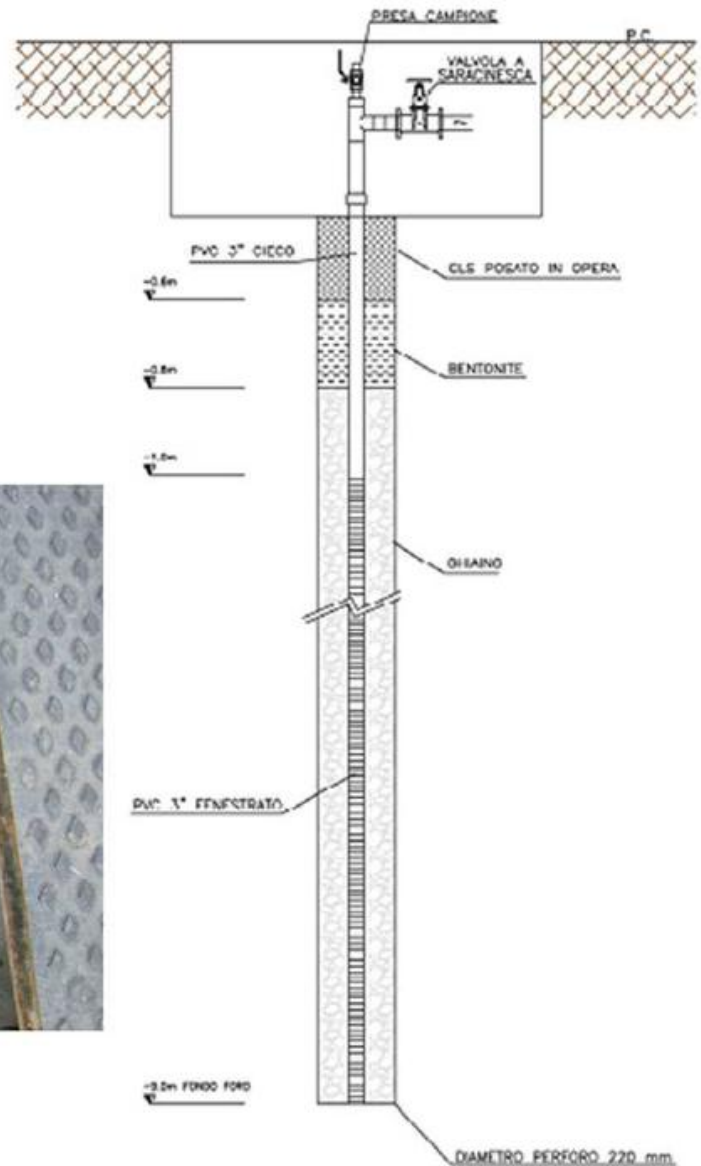

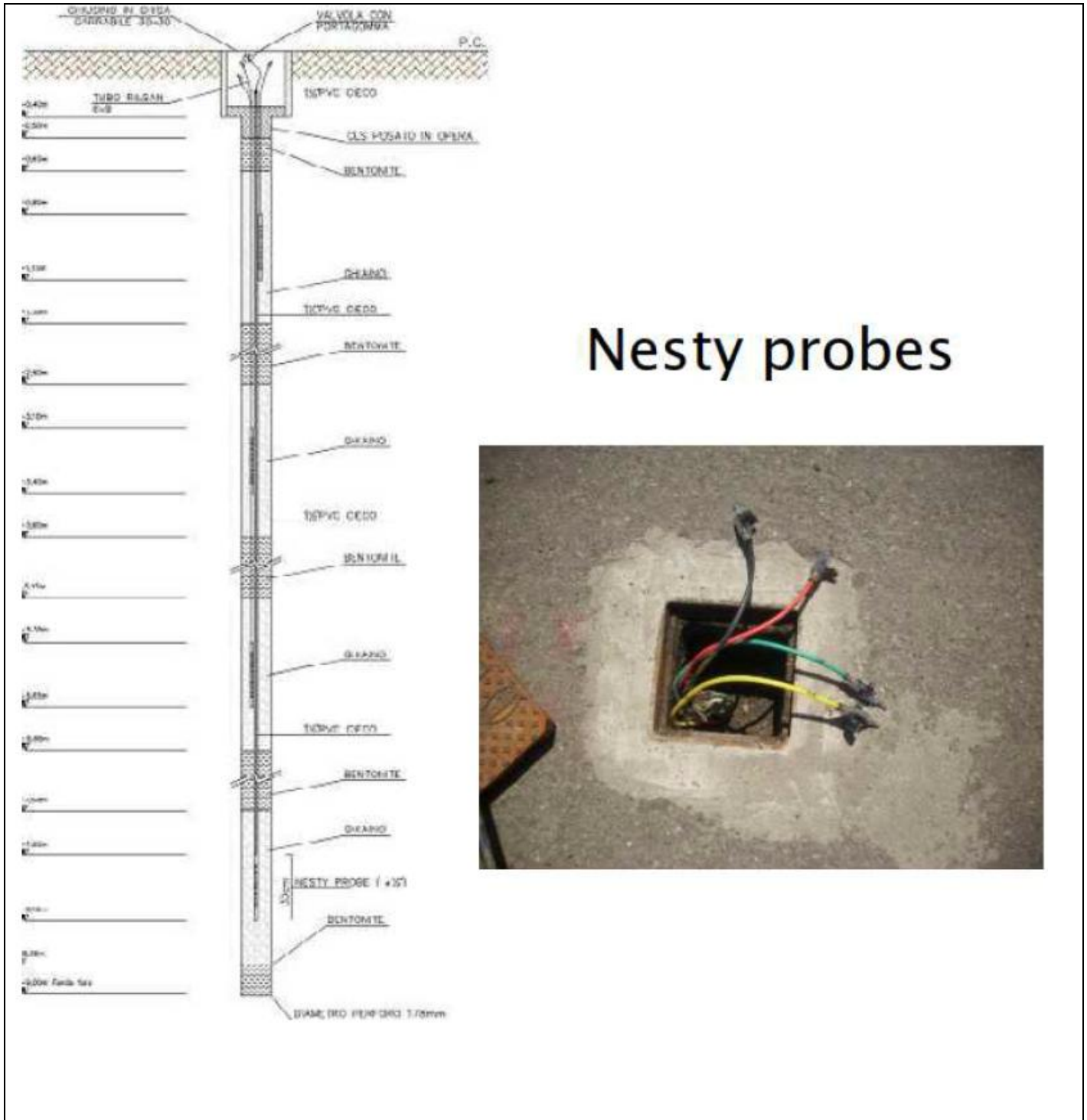

# Nesty probes



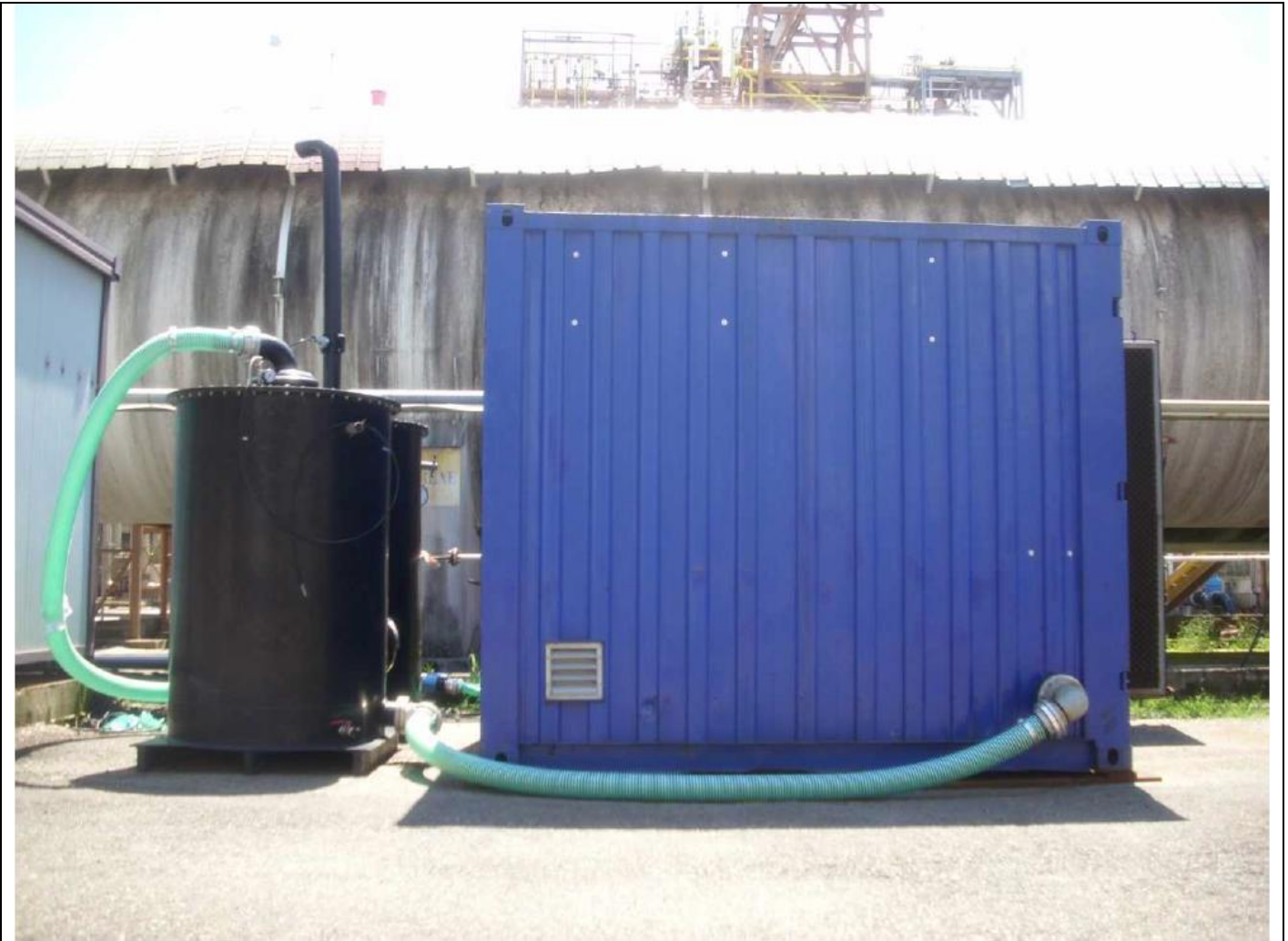





### 3.3 Radius of influence

Tests performed:

- n. 2 step vacuum test
- n. 5 long-term tests at constant vacuum

Results:

- ROI = 9 ÷ 10 m (cutoff -2.5 Pa)
- Flow rate each SVE ~ 130 mc/h
- Vacuum @ SVE head: ~ - 30 mbar

Moreover:

- n. 4 SVE points showed a good overlap of influence areas covered by each point
- granular activated carbon filters showed good removal of contaminants present in the extracted vapours

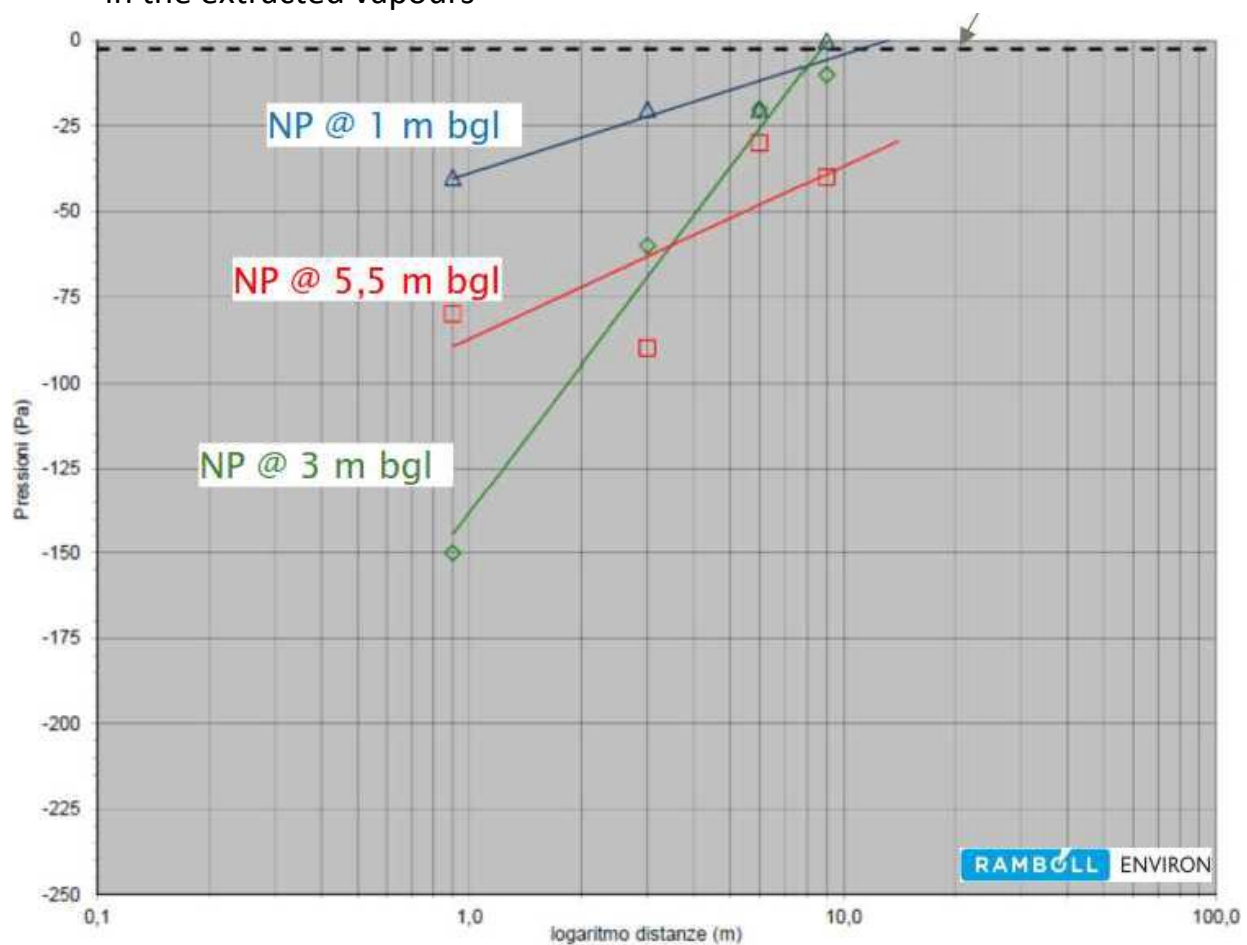



### 3.4 Off gas Treatment

During the pilot test the extracted vapours were treated by # 2 granular activated carbon filters connected in series (1,000 litres each ).

### 3.5 Control parameters

To assess the effectiveness of the treatment and evaluate the ROI, the following parameters were monitored during the pilot scale application:

- $\Delta P$  in/out blower;
- Vacuum at the wellhead of the suction point/points;
- Vacuum induced at the soil gas monitoring points (Nesty Probes) at different distances and depths from the extraction well/wells;
- Flow rate of extracted gases;
- VOC concentrations before and after treatment;
- $O_2$ ,  $CH_4$ ,  $CO_2$  monitoring at each SVE extraction and NP monitoring point before VOC sampling.

## 4. Full-scale application

### 4.1 Extraction system

The Full Scale SVE has been designed considering the Pilot Test results (ROI, flow rate per each extraction point, vacuum to be applied at each extraction point) and taking into account the whole area to be remediated:

- n. 18 SVE points;
- distance between extraction points:  $L=2(ROI) \cos 30 = 17 \text{ m}$
- Design flow rate = 2340 mc/h
- N. 4 blower (750 mc/h @  $\Delta P$  150 mbar - each)
- N. 4 Granular Activated Carbon filters (4000 l – each – 2 duty/2 standby)









### 4.3 Radius of influence

The SVE Full Scale ROI is in line with the result of the SVE Pilot Test: about 9-10 m.

### 4.4 Off gas Treatment

As for off-gas treatment, #4 Granular Activated Carbon filters (4000 l - each- 2 duty/2 duty/2standby) were installed

### 4.5 Control parameters

To assess the effectiveness of the treatment the following parameters were monitored with the following frequency

Every two days:

- Monitoring of emissions into the atmosphere with short term tubes

On a weekly basis:

- Air flow and extraction rates
- $\Delta P$  in/out blowers, vacuum induced in each SVE extraction point
- Temperature in/out blowers
- VOC analysis before vapour treatment for each blowers
- Measure of piezometric level in monitoring points present in the area

Every two weeks

- VOC analysis of the treated vapours

On a quarterly basis:

- VOC, O<sub>2</sub>, CH<sub>4</sub>, CO<sub>2</sub> and vacuum induced at each SVE extraction and NP monitoring point

After the first three years monitoring plan has been modified in agreement with Authorities, and all the activities conducted on a weekly basis until 2016 were then conducted every two weeks. The above monitoring activities allowed also to calculate the VOC mass removal



## 6. Post treatment and/or Long Term Monitoring

### 6.1 Post treatment and/or Long Term Monitoring

The long term monitoring shows the effectiveness of the remediation technology applied.

The monitoring data collected allow to calculate quite a high CHCs mass removed from the unsaturated soils and show a clear evolution (depletion) over time of the CHCs concentrations measured at the SVE points.

In fact, considering both the pilot plant (active in the period May 2011 - May 2013) and the Full Scale plant (August 2013 - January 2019), the SVE system removed about 5238 kg of CHCs:

- Tetrachloromethane: 3171 kg
- Trichloromethane: 1814 kg
- Trichlorofluoromethane: 253 kg

From the results of quarterly analyses of VOC content in the vapour extracted from the extraction points in the area of the SVE intervention, isoconcentration maps for the above mentioned three contaminants in soil gas could be drawn.

These maps show a progressive decrease in concentrations over time after starting the SVE system.

Following the achievement of the technological limit of the SVE application (asymptotic value of the extracted mass) Stop & Go tests were performed. The tests showed a negligible rebound of the concentration and consequently the SVE system was stopped and confirmatory soil samples were taken which all showed CHCs concentrations below the CSR and also the CSC values.

## 7. Additional information

### 7.1 Lesson learnt

Although the characterization surveys, performed initially by drilling boreholes, indicated only few CSC exceedances of the CHCs concentration in the soil samples, the application of the SVE system allowed to remove a high mass of VOCs. In order to properly size remediation interventions, it is therefore important to carry out a more detailed characterization of the potential contamination sources in the unsaturated soils using advanced investigation techniques such as, for example, Soil Gas Survey, Membrane Interface Probe Investigations, Passive Soil gas Survey, etc..





## 7.2 Additional information

To assess the success of the remediation it is necessary to perform:

- trend analysis of each contaminant monitored over time with respect to the initial baseline value.
- quantification of extracted VOC mass over time

## 7.3 Training need

To ensure the achievement of remediation goals it is necessary to perform a good operation and maintenance of the overall system. To do this it is important that the system is managed by trained personnel.

## Glossary of Terms

<b>Term (alphabetical order)</b>	<b>Definition</b>
VOC	Volatile organic compounds (VOCs) are organic chemicals that have a high vapour pressure at ordinary room temperature
CHCs	Chlorinated Compounds
SSTLs or CSR	Site Specific Target Level, which are named CSR in Italian regulation, are concentration target levels defined according to Risk Analysis procedure

## 1. Contact details - CASE STUDY: SVE n.14

<b>1.1 Name and Surname</b>	Ewa Szczebak
<b>1.2 Country/Jurisdiction</b>	Poland
<b>1.3 Organisation</b>	Arcadis
<b>1.4 Position</b>	Senior Environmental Specialist
<b>1.5 Duties</b>	Environmental consulting regarding soil and groundwater investigation, remediation, risk assessment. Project management.
<b>1.6 Email address</b>	<a href="mailto:ewa.szczebak@arcadis.com">ewa.szczebak@arcadis.com</a>
<b>1.7 Phone number</b>	

## 2. Site background

### 2.1 History of the site

The site is an active railway area with 4 main tracks and some crossovers. Soil and groundwater was contaminated in 2010 due to a spill of app. 800 Mg of petroleum products (mostly diesel) after a train crash. The maximum admissible concentrations for soil and groundwater are exceeded for light and heavy petroleum hydrocarbons and BTEX.



## 2.2 Geological setting

Site soil consists largely of fine and medium sands, locally overlaid by sandy loam. Uppermost soil layer is man-made fill (consisting of sandy loam with crushed bricks) and railroad ballast below the tracks. The depth to groundwater is approximately 7 meters below ground surface on the railway area and approximately 5 m bgs on the outflow.

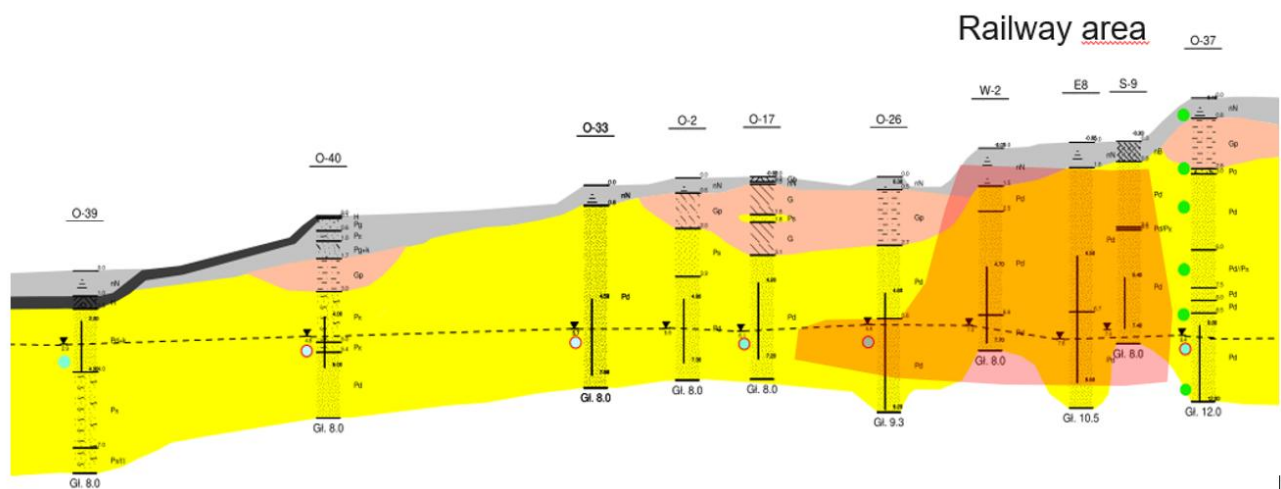

## 2.3 Contaminants of concern

The contaminants of concern detected in soil:

- Total Petroleum Hydrocarbons fraction C6-C12: BDL – 10,600 mg/kg
- Total Petroleum Hydrocarbons fraction C12-C35: BDL – 40,000 mg/kg
- Toluene: BDL – 57 mg/kg
- Ethylbenzene: BDL – 426 mg/kg
- Xylenes: BDL – 1,240 mg/kg

The contaminants of concern detected in groundwater:

- Total Petroleum Hydrocarbons fraction C6-C12: BDL – 4,990 mg/L
- Total Petroleum Hydrocarbons fraction C12-C35: BDL – 1,490 mg/L
- Benzene: BDL – 0.5 mg/L
- Toluene: BDL – 29 mg/L
- Ethylbenzene: BDL – 76 mg/L
- Xylenes: BDL – 200 mg/L



## 2.4 Regulatory framework

Due to a damage in environment after the spill of hydrocarbons the administrative procedure has been initiated. The first step was the extensive site investigation executed in a few rounds, including soil and groundwater sampling, monitoring wells installation and observation of groundwater and LNAPL behaviour. Based on the laboratory results of soil and groundwater samples, exceedances of relevant environmental standards were assessed. Remediation Action Plan was submitted to the Regional Environmental Agency, with the aim of remediation – achievement of soil and groundwater standards. After few a years of remedial system operation (LNAPL skimming enhanced with groundwater drawdown, and venting barrier on the outflow) the law in Poland has changed and the risk-based approach has been implemented. Therefore, the application for remediation based on human health and environmental risk-assessment was submitted to the Regional Environmental Agency. The proposed remedial goal is to limit the migration of contaminated groundwater. The SVE system is a part of venting barrier, consisting of air sparging (AS) system and soil vapour extraction (SVE) system. Due to close distance between barrier and office building, the SVE system is operating to prevent potential vapour intrusion into the building.

## 3. Pilot-scale application in field

### 3.1 Extraction system

The main goal for the SVE system was to extract contaminants in the gas phase in the area of air sparging system operation. Therefore, pilot tests were carried out on the injection wells screened in the aquifer. Since the geology of vadose and saturated zone is similar (fine sand along the whole profile), the radius of influence of extraction wells was established according to AS pilot tests.



## 3.2 Injection system

One injection well and three monitoring points were installed in a line for the field test of air sparging (AS) technology. The location of the test was based on future potential venting barrier location. Distance between the injection well and monitoring points was between 1.6 and 2.5 m and it was adjusted due to the presence of underground utility lines (i.e. power line, optic fiber, sewer system). The air was injected by a blower, to a depth of 1.7 – 2.0 m below the groundwater table.



### 3.3 Radius of influence

Radius of influence (ROI) at around 5 meters was calculated for the air sparging test (air injection into one well and observations in 3 points). The observed parameters were: groundwater level and pressure versus distance. A groundwater level increase of 0.1 m was considered as the boundary of the effect of AS well. Scheme of AS test is presented below.

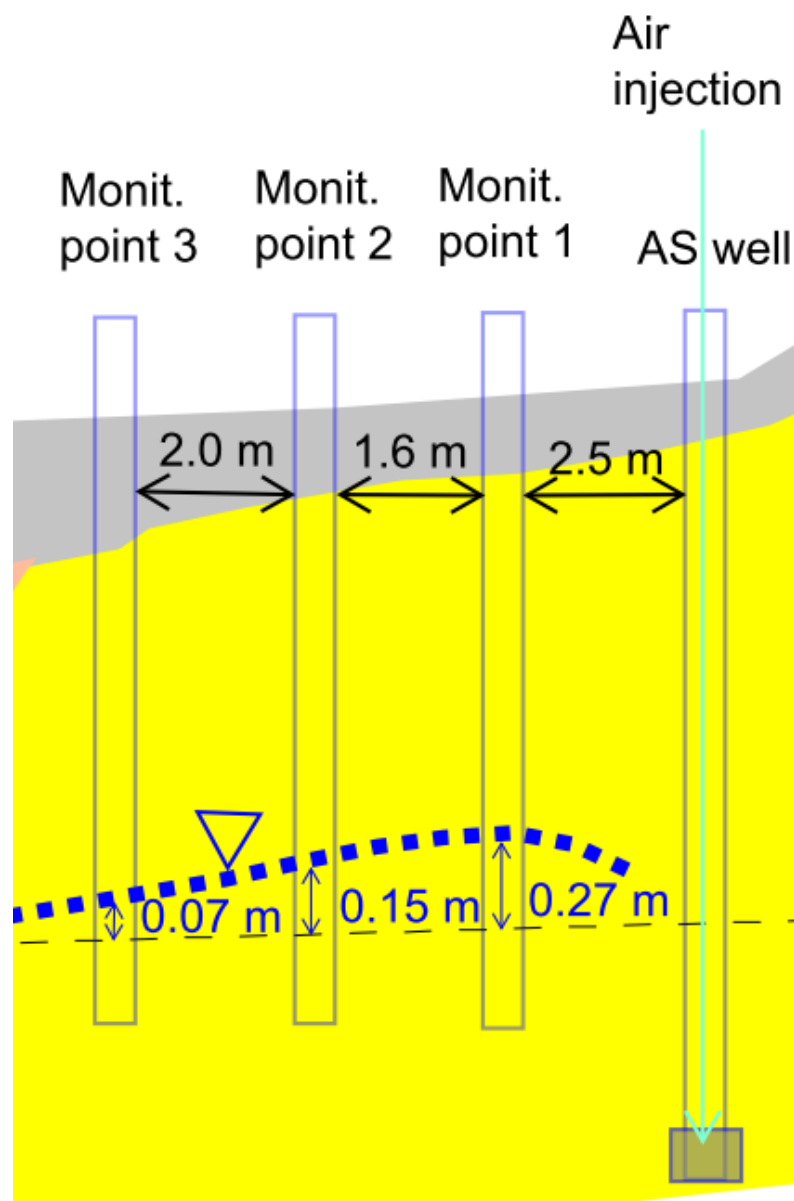



### **3.4 Off gas Treatment**

No off gas treatment was installed for the pilot test, because the test was based on air injection, not extraction.

### **3.5 Control parameters**

For the pilot scale of AS system, it was useful to monitor the oxygen concentrations in monitoring points and in surrounding GW monitoring wells. The increase of oxygen in groundwater was fast and direct proof of effectiveness of air injection.

## **4. Full-scale application**

### **4.1 Extraction system**

The SVE system includes the following equipment: a metal container measuring 3 m wide by 10 m long by 3 m high; 11 horizontal vapour extraction wells; and one air compressor. In addition, the system includes a filter with activated carbon to treat the contaminated air.

The soil vapour extraction system consists of eleven 2-inch diameter horizontal wells screened at depth of app. 4.0 – 4.2 m bgs. The wells are combined with pipelines and work as two separate lines, set between two lines of air injection wells.

The SVE system works at intervals alternately with AS system, time of each interval is half an hour.

## 4.2 Injection system

The air sparging system includes the following equipment: a metal container measuring 3 m wide by 10 m long by 3 m high; 13 horizontal air injection wells; and one blower. The AS system consists of thirteen 2-inch diameter horizontal wells screened at depth of approx. 7.0 – 8.2 m bgs. The wells are combined with pipelines and work as two separate lines, set between two lines of vapour extraction wells. The AS system works at intervals alternately with SVE system, time of each interval is half an hour.

## 4.3 Radius of influence

Radius of influence (ROI) was calculated for the air sparging test (air injection into one well and observations in 3 points) at around 5 meters. The observed parameters were: groundwater level and pressure versus distance. A groundwater level increase of 0.1 m was considered as the boundary of the effect of AS well. Scheme of AS test is presented below.

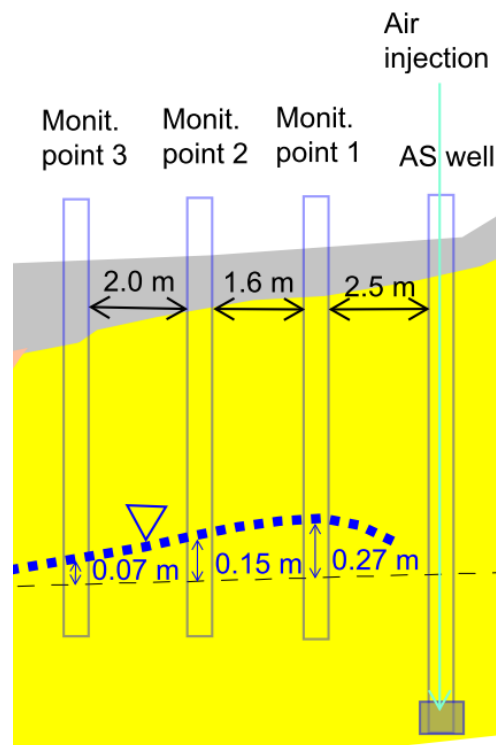



## 4.4 Off gas Treatment

Activated Carbon Adsorption is used as treatment method for off gas. A vertical filter with a capacity of 1 cubic meter is installed in the container. Granulated activated carbon is used as air emissions treatment.

## 4.5 Control parameters

- PID measurements are taken once a year in extraction points to check the effectiveness of vapour extraction.
- Periodically a PID measurements in the off-gas are taken to control the effectiveness of soil gas treatment.
- Water levels are measured regularly to control proper work of AS system.
- Contaminant concentrations and basic physical-chemical properties are measured in GW twice a year as part of groundwater monitoring programme for the site.

# 6. Post treatment and/or Long Term Monitoring

## 6.1 Post treatment and/or Long Term Monitoring

PID measurements have been taken once a year in extraction points to check the effectiveness of vapour extraction.



## 7. Additional information

### 7.1 Lesson learnt

1. **methodology and procedures:** before the installation of full-scale system, the hydrogeological data from 1-2 years of measurements (dependent on the local hydrogeology conditions) should be gathered and analyzed. It would help to avoid a situation of eventual groundwater level rise causing flow of the groundwater into extraction wells (i.e. danger of equipment damage). And for the AS system it would help to install injection wells to a reasonable and cost-effective depth.
2. **technical aspects:** the system generates a lot of heat, therefore the building where the equipment is installed should be adequately designed to decrease the indoor temperature in the summer (i.e. ventilation). Location of wells and related interdistance for the full scale system are determined also by the local conditions (i.e. underground utility lines, land accessibility). Therefore, it should be considered when designing the system to keep the proper influence area.
3. **regulatory aspects:** it would be much easier to conduct pilot studies of proposed remedial technology before the submission of Remediation Action Plan (RAP). Since after the entry into force of the new regulation, formally you should submit a RAP just after a contamination is acknowledged. Therefore, understandably, most of the clients prefers to submit the RAP before field tests. Then, if field test results show a lack of effectiveness of the proposed technology, RAP should be amended.



## 7.3 Training need

Training would be recommended both for consultants (for better understanding of the methodology and its needs) and for the authorities (for better understanding of the capabilities of SVE and the need of field tests prior the full scale system installation). Workshops and presentations about case studies are an effective learning tool.

## Glossary of Terms

<b>Term (alphabetical order)</b>	<b>Definition</b>
AS	Air Sparging
BDL	Below Detection Limit
BGS	Below Ground Surface
BTEX	Benzene, Toluene, Ethylbenzene, Xylenes
GW	Groundwater
LNAPL	Light Non-Aqueous Phase Liquid
RAP	Remedial Action Plan – an official document submitted to the authority for approval
ROI	Radius of Influence



## 1. Contact details - CASE STUDY: SVE n.15

<b>1.1 Name and Surname</b>	Puricelli Sara, Marin Rosa Angela, Ricci Diego, Confalonieri Massimiliano
<b>1.2 Country/Jurisdiction</b>	Italy
<b>1.3 Organisation</b>	ARPA Lombardia
<b>1.4 Position</b>	
<b>1.5 Duties</b>	
<b>1.6 Email address</b>	s.puricelli@arpalombardia.it m.confalonieri@arpalombardia.it
<b>1.7 Phone number</b>	+39 031 2743913



## 2. Site background

### 2.1 History of the site

The area in question is an active industrial production site that carries out engineering activities and is located in Northern Italy.

The site was divided into three portions for different distribution and characteristics of the secondary sources and managed with different remediation approaches.

Unlike the other sites managed through reductive dehalogenation processes, the one in question provided for treatment through AS/SVE for the following reasons:

- in this portion there is no natural anaerobic degradation process of the chlorinated organic compounds;
- the speed of the local water table is significantly higher than the other two source areas (at least double) and would not allow an adequate residence time of the injected substrate in the intervention area, effectively nullifying its effectiveness.

There are no specific protocols for the management of the site, but the control and technical evaluation activities in support of the Municipality (proceeding administration appointed by the Region for the management of contaminated sites) are carried out by ARPA. ARPA Lombardia is an environmental protection agency established in 1999 that deals with the prevention and protection of the environment, supporting regional and local institutions in multiple activities: from the fight against atmospheric and acoustic pollution to interventions for the protection of surface and groundwater, from monitoring electromagnetic fields to investigations on soil contamination and remediation processes.

## 2.2 Geological setting

From the hydrogeological point of view, the site is characterized by a single undifferentiated aquifer, which rests on a rocky substrate about 35 m from ground level, as shown in the section below.

The hydraulic conductivity, in the portion of the site of interest is of the order of  $3-4 \cdot 10^{-5}$  m/s, resulting in a rather high water table speed, with flow direction from West to East. The average subsidence of the aquifer is about -13 m from ground level.

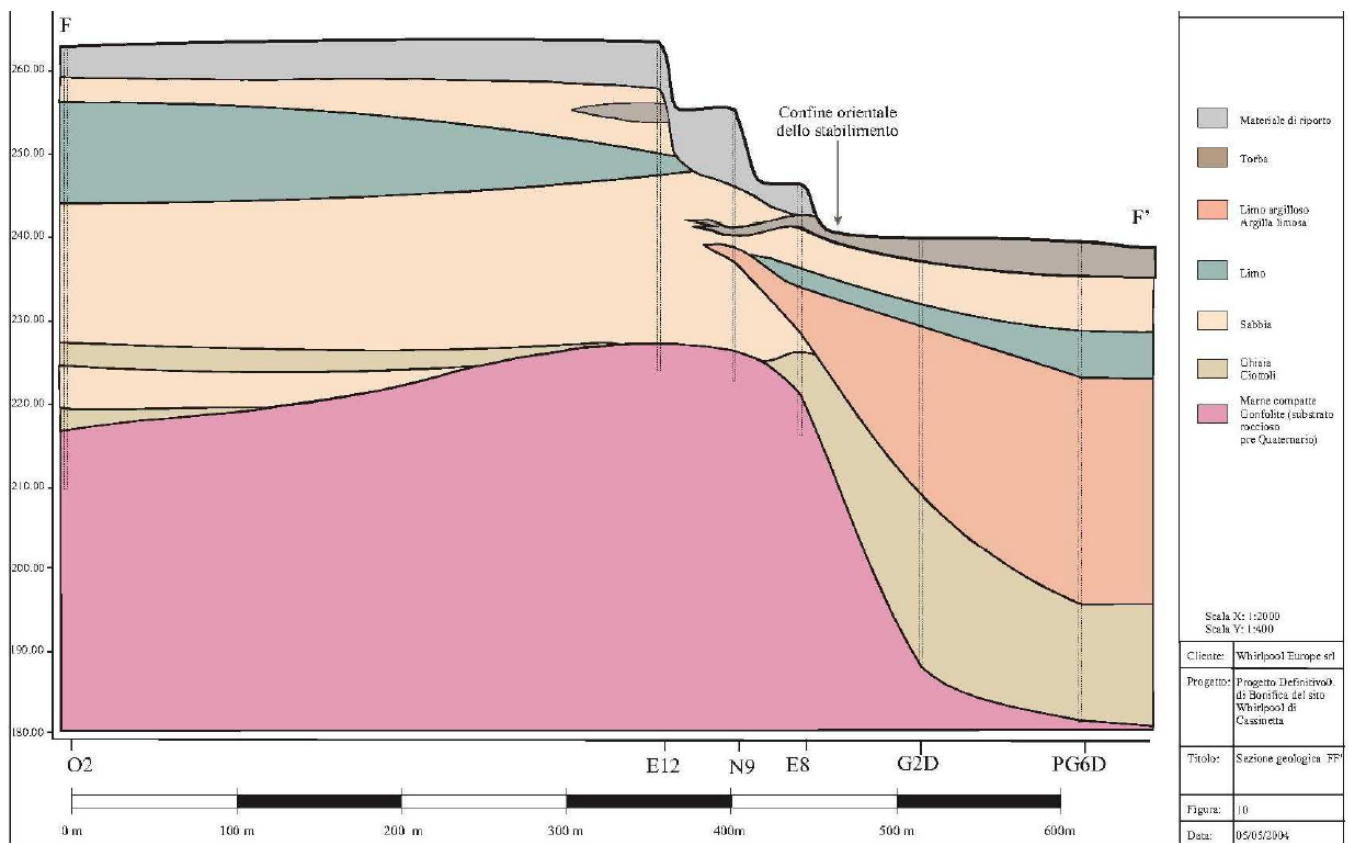



## 2.3 Contaminants of concern

Due to the production activities carried out, the groundwater was contaminated by chlorinated solvents, mainly tetrachlorethylene (PCE), trichloroethylene (TCE), 1,2-dichloropropane (DCP), cis 1,2-dichloroethene, 1,2-dichloroethane and vinyl chloride. In detail, TCE, DCP and PCE are to be considered primary pollutants, as they were actually used in the production processes of the plant during the 1960s and 1980s, while the other compounds are the products of the partial natural degradation of the previous ones.

The concentrations are very high, for some compounds in the order of mg/l. In particular, at the time of the start of the treatment in question were recorded maximum TCE values of 7.1 µg/l, DCP of 4 µg/l, PCE of 4100 µg/l and summation of organohalogen compounds of 4110 µg/l (thus demonstrating that most of the contamination is due to PCE), compared to regulatory limits for groundwater, respectively, of 1.5 µg/l, 0.15 µg/l, 1.1 µg/l and 10 µg/l for the summation.

The characteristic contaminants are essentially found in the saturated part of the subsoil, while in the unsaturated zone they were not detected in significant concentrations, thus excluding the presence of hot spot of contamination in the unsaturated zone.

## 2.4 Regulatory framework

The procedure was conducted pursuant to Legislative Decree 152/2006.



## 3. Pilot-scale application in field

### 3.1 Extraction system

The technique involved the combination of an air injection system at the bottom of the saturated area, Air Sparging (AS), and a system for extracting the vapours produced (Soil Vapour Extraction - SVE).

In detail, the first is aimed at stripping volatile contaminants present in groundwater, favouring their passage into the vapour phase and therefore their migration into the unsaturated portion of the soil, from which they are then removed thanks to the SVE system in the atmosphere following appropriate treatment.

The pilot scale tests were carried out in the period between April 2008 and June 2009, autonomously from the party without the adversary of ARPA.

### 3.2 Injection system

As in the saturated area, compressed air was injected.

### 3.3 Radius of influence

The range of influence was obtained from direct tests in the field, evaluating the depression exerted in the control wells. Support model simulations were not used.

### 3.4 Off gas Treatment

The gas treatment system is similar to that which was then implemented in the full-scale plant, described in detail in sheet 4.4.



### 3.5 Control parameters

The monitoring of the pilot plant consisted in the quantification of chlorinated compounds both in the air extracted from the SVE wells installed in the unsaturated state, and in the groundwater taken from the wells in the saturated state.

At the end of the pilot plant, quantities greater than l.q. only for TCE and PCE (expressed in mg/l) were found in waters, while the other chlorinated compounds possibly present showed negligible concentrations.

From the data found in the extracted gases it emerged that:

- the extraction of vapour phase contaminants from the SVE wells from the unsaturated soil was efficient and allowed the achievement of concentrations of chlorinated compounds in the vapours of up to  $1 \text{ g/m}^3$ ;
- the quantity of extracted contaminants is significantly greater in the deepest unsaturated wells among those used, that is, in those cracked near the capillary fringe compared to that of the more superficial wells;
- - the contaminants present in the extracted vapours essentially come from the stripping of groundwater and not from the presence of contaminants in the unsaturated zone; in fact, in the absence of compressed air injection, concentrations of contaminants were found to be considerably lower in the interstitial vapours than those detected with the AS system on.

## 4. Full-scale application

### 4.1 Extraction system

4 SVE wells were used and installed in the unsaturated domain, of which 1 was existing and 3 were installed new, headed about 1 m above the surface of the aquifer (indicatively therefore up to an altitude of 12 m) and cracked for 5 m.

Each SVE well was combined with a pair of AS wells, which were bored in the immediate vicinity of the saturated domain.

The figure shows the plan of the AS/SVE system built on the site. In it are indicated:

- in blue the wells connected to the AS plant (the PAS1S-1D pair had been used in the small-scale intervention);
- in red the wells connected to the SVE plant (SVEFT3S was used for the pilot plant);
- in green the piezometers that are planned to be used as water monitoring points.

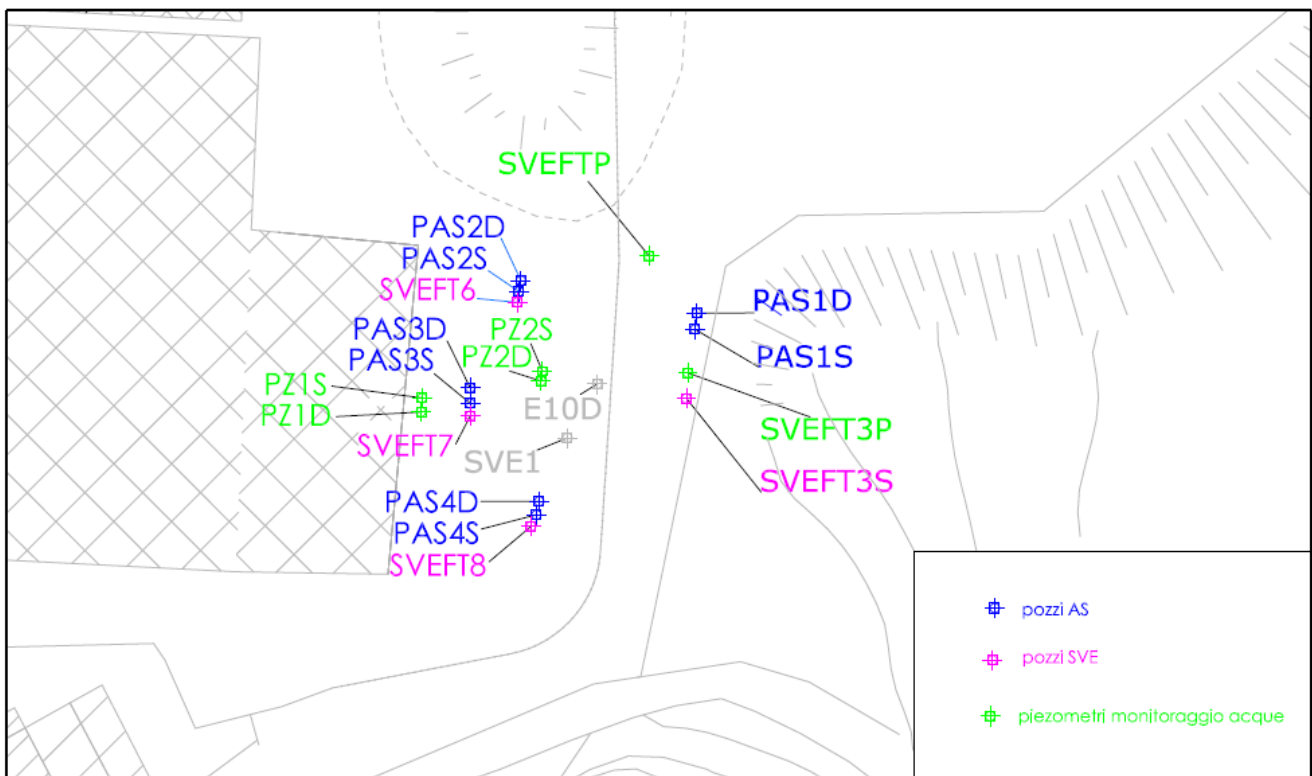

In detail, the SVE system consisted of the following components:

- 1 centrifugal aspirator with 2.5 - 3 kW power, with a flow rate of 150 Nm<sup>3</sup>/h at a depression of 120 mbar;
- 4 steam extraction pipes from as many SVE wells;
- 4 wellhead connections, designed for the measurement of air flows, depression and the taking of steam samples;
- 4 butterfly valves to control the flow rates of each suction well;





- 4 vacuum gauges;
- 4 valves for fine adjustment of the extracted flow rates;
- 1 manifold for collecting the suction pipes arriving from the wells;
- 1 dust collector filter for atmospheric air;
- 1 condensate separator, with relative booster pump;
- 1 activated carbon filter for condensate treatment;
- 2 activated carbon filters for air, connected in series and intended for the treatment of vapours;
- connection pipes, valves, various fittings, measurement and regulation sections, pneumatic quick couplings;
- command and control instrumentation (electrical panel in common with the AS system) which allowed manual or automatic operation;
- 1 container housing the entire system (shared with the AS system).

The system has been designed to guarantee a flow rate of continuously extracted vapours equal to at least double the flow rate of the air blown into the groundwater, and therefore overall capable of sucking at least 120 Nm<sup>3</sup>/h.

In the event of operating anomalies, a GSM telephone dialer was arranged who could send the error reports to specialized personnel able to restore the functionality of the system.

All quick-connect points have been prepared for taking steam samples and for inserting the following portable field instruments online:

- digital or analogical vacuum gauges for measuring depression;
- PID probes for indirect detection of VOC concentration;
- anemometers for measuring the extracted airflow.

The full-scale plant was started up in March 2013.

Here are some pictures of the AS/SVE system.





## 4.2 Injection system

4 pairs of groundwater insufflations wells (AS) were built, of which, n. 1 was existing and n. 3 were newly installed, each capable of guaranteeing the injection for 5-10 minutes of approximately 30 Nm<sup>3</sup>/h of air at an injection pressure of at least 3 bar.

Approximately, for each side-by-side, a well has a depth of 25 m from b.g.l. and the other 30-35 m from ground floor; given the nature of the compounds, with a density greater than that of water, the cracked section is located on the bottom and has a length of about 50 cm.

The AS system consisted of the following components:

- 1 rotary compressor (able to guarantee air flows of at least 70-100 Nm<sup>3</sup>/h at a pressure of 4 bar, imposing a maximum pressure of 10 bar);
- 1 storage tank for compressed air (volume 270 l), equipped with a 0-16 bar pressure gauge and safety valve for venting overpressures;
- 1 airtight compressed air delivery pipe to the distribution system, equipped with a pressure regulator (0-10 bar);
- 8 independent insufflations pipes;
- 8 wellhead connections;
- 8 analogical flow meters and 8 pressure gauges;
- 8 timed solenoid valves for air distribution in AS wells;
- 8 manual ball valves for regulating the airflow on the individual wells;
- connection pipes, valves and various fittings, measurement sections by means of float flow meters and flow regulation;
- command and control instrumentation (electrical panel in common with the SVE system);
- 1 container housing the plant (shared with the SVE system).

Downstream of the storage tank, the compressed air passed through a de-oiler filter equipped with a timed vent valve, which allowed the elimination of any oily condensate formed in the machine, preventing it from entering the groundwater.

In order to ensure the efficiency of the insufflations process, the system was set to automatically blow about 30 Nm<sup>3</sup>/h of air into a pair of wells for a duration of 5-10 minutes, while the other three pairs remained inactive.



### 4.3 Radius of influence

The range of influence was defined based on the evaluation of the pilot test.

### 4.4 Off gas Treatment

Before the final discharge into the atmosphere, the extracted vapours were subjected to purification treatment with the following characteristics:

- number of filters 2;
- total filter volume 800 l;
- quantity of GAC (granular activated carbon) 360 kg total;
- filter section 800 mm
- filtration speed 0.11 m/s
- total contact time 14.4 s.

These characteristics, established on the basis of what was verified with the pilot scale test, ensured compliance with the limits set by Legislative Decree 152/06 for each of the site-specific gaseous compounds.

The protocol provided for the replacement of spent activated carbon and its subsequent dispatch for disposal/regeneration in authorized external plants to be carried out before the reduction in the efficiency of the vapour treatment system would not allow compliance with the emission thresholds.

## 4.5 Control parameters

The monitoring plan included:

- monitoring of the vapours extracted from the SVE wells and entering/leaving the vapour treatment plant;
- periodic inspection, maintenance, and adjustment of the AS/SVE system;
- the collection and analysis of water samples, measurement of chemical-physical parameters of the water (dissolved oxygen, redox potential, pH, temperature) in 9 piezometers, available in the intervention area as well as 1 new downstream (G16) made at approximately 110 m away from the treatment area, aimed at evaluating the influence of the AS treatment on the measured solvent concentrations with respect to a blank campaign at the initial time

In fact, immediately after the start-up of the SVE plants (in March 2013) and before the start-up of the AS system, a sample of vapours was taken from each of the suction wells, analyzed for chlorinated solvents, which constituted the "blank" as not yet influenced by the simultaneous start of the insufflations of air in the saturated portion of the local subsoil. After that, the AS system was also started.

The location of the monitoring points of the 9 monitoring piezometers is visible in the following figure.

The monitoring during the execution of the intervention took place on a quarterly basis.

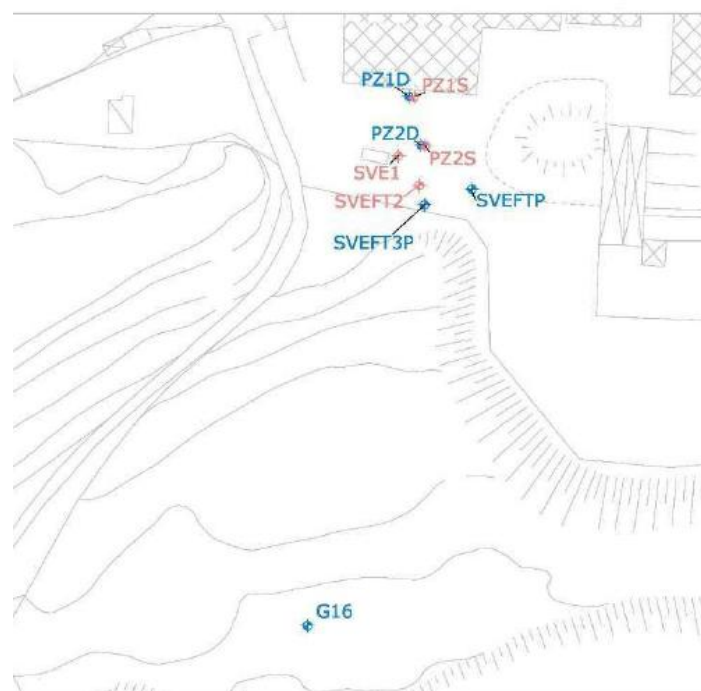



## 5. Enhancements to SVE

### **5.1 Pneumatic and/or hydraulic fracturing**

Discontinuous operating periods of the plant have been implemented, as described in § 6.1, in order to intervene on rebound phenomena and periodically evaluate the plant's cost/benefit effectiveness.





## 6. Post treatment and/or Long Term Monitoring

### 6.1 Post treatment and/or Long Term Monitoring

From the evaluation of the monitoring data, it was found that the wells from which the greatest extraction of contaminants takes place are SVEFT7 and alternatively SVEFT8. From the start of the intervention in July 2017, considering the total flow rate detected on the delivery section of the blower and the concentrations detected, it was possible to estimate the mass of contaminants extracted during the execution of the AS/SVE intervention equal to approximately 645 kg of organochlorinated solvents, consisting mostly of PCE.

On the occasion of the monitoring in July 2017 it emerged that:

- in the water taken from the piezometers of the deep portion of the aquifer, a clear reduction in the concentrations of contaminants present, up to over 90% of the initial values, and in particular of PCE and TCE, emerged;
- even in the waters taken from the piezometers of the surface portion of the aquifer, a decrease in concentrations was found even up to over 90% of the initial values;
- in the waters of the G16 piezometer, located downstream from the intervention area, fluctuating concentrations were recorded after treatment but with a decreasing trend, however with still considerable residual values. This was probably due to the considerable distance from the intervention area and the presence of a peaty horizon at a depth of about 6 m which could have limited the impregnation of the contaminants thus allowing their release over time. It was considered that it would have been necessary to wait a very long time before having an effect similar to that obtained in the intervention area. Following the concentrations detected in this piezometer, hydraulic containment was active downstream to it;
- overall, the concentration of contaminants in the extracted vapour stream decreased significantly over time, but detectable concentrations were still present in the extracted stream.

In general, from the examination of the results of the analyzes performed and the graphs that show its trend, the decrease in the concentrations of the summation of chlorinated solvents with respect to  $t_0$  emerged over time and the asymptote conditions seemed to be reached in the intervention area.

In May 2018 and up to December 2018, the AS/SVE systems were therefore shut down, and new monitoring was carried out starting from the end of the following month. There was thus an increase in concentrations in the groundwater of the intervention area, in





particular in the more superficial PZ1S and Pz2S piezometers.

It was therefore considered useful to restart the plant again for a further period of six months in order to allow further massive extraction of the contaminants present, until July 2019. The monitoring carried out following the reactivation of the plant certifies the removal of a mass of contaminants equal to 16 kg over a period of approximately 7 months.

The analytical results of the PZ1S and PZ2S piezometers show, in the period following the reactivation of the system, still significant concentrations of chlorinates in the PZ1S and PZ2S piezometers.

The AS/SVE intervention was deactivated in July 2019 and a new monitoring took place 6 months after the shutdown.

Overall, the removal of approximately 660 kg of PCE has been estimated during the operating period (2013-2020), with a decreasing trend over time.

In 2020, the authorities accepted the request to shut down the system because from the cost-benefit ratio of the treatment it emerged that it was no longer the best intervention technique at sustainable costs. This decision was reinforced by the fact that there is a hydraulic barrier at the border, and therefore an operational safety device (MISO).

The monitoring of groundwater after the works, downstream of the closure of the intervention, was prescribed on a quarterly basis until the remediation of the control piezometers provided for the area is completed, and then for another 2 years every six months.



## 7. Additional information

### 7.1 Lesson learnt

The remediation intervention allowed the removal of part of the contaminants, but did not prove decisive, as can be seen from the analysis of the analytical data on groundwater. It can be hypothesized that the specific geological and hydrogeological characteristics of the site have reduced the effectiveness of the scheme, in particular for the fine lithology of the area (peat, silt and clayey sand) and for the scarce subsidence that with seasonal fluctuations, prevented as a matter of fact the volatilization of the contaminants in the interstitial spaces of the unsaturated portion and the subsequent removal.

It could have been appropriate to undertake an evaluation of the behaviour of the plant, both for the purposes of designing it and predicting its behaviour, also to optimize its management, by means of a two-phase numerical modelling simulation, which considered the behaviour of air and water in the aquifer, evaluating the phase passage of pollutants over time and as a function of air injection/gas extraction, such as Petrasim.



## 7.2 Additional information

The Final Reclamation Project was based on a double criterion to establish the achievement of the reclamation:

a) limits in the treatment area that ensure compliance with the legal values (CSC) on the legal boundary of the site derived from the application of groundwater transport models used for the Risk Analysis. In detail, the reclamation limit concentrations were calculated using the Ogata Banks model, both for the deep aquifer and for the superficial aquifer, applying the appropriate values of the hydrogeological parameters for each, obtained through dedicated calibration.

The following table summarizes the concentrations ( $\mu\text{g/l}$ ) admissible at the end of the remediation operations.

TCE	PCE	DCP	DCE	DCA	VC
2.57	17.85	1498	42.69	29.57	2.98

b) technical remediation limit, was considered reached when the decrease in the concentrations of contaminants in the groundwater stabilized around an asymptotic value of the reduction in the concentrations of chlorinated solvents below the limit values calculated with the Ogata Banks model. In particular, following the identification of the achievement of the asymptote (verified by evaluating the analytical results of 3 subsequent samplings), provisions had been made for the suspension of the remediation activities and the subsequent execution of verification samplings on a quarterly basis and then half-yearly.



## 7.3 Training need

There is a need for specific training for more in-depth design assessments, such as the use of two-phase numerical models to design and manage an AS/SVE system adequately and in a site-specific manner.

## 7.4 Additional remarks

Here are some indications on costs:

1	Organizzazione, supervisione attività / Report finale	€	9.000,00
2	Realizzazione pozzi e piezometri	€	52.000,00
3	Installazione impianti / Demobilizzazione impianti a fine intervento	€	12.600,00
4	Gestione e monitoraggio intervento	€	47.600,00
		<b>€</b>	<b>121.200,00</b>

## Glossary of Terms

A glossary will help a you to maintain the level of precision necessary for key terms and maintain consistency across the text. We found out that sometimes terms that sounds similar like “contaminated” and “polluted” are used in the same way as synonyms in some country, while in other they have different meanings (due to legislation or for other reasons). So fill in this glossary for your key elements and of course for acronyms.

<b>Term (alphabetical order)</b>	<b>Definition</b>
AS	Air Sparging
GAC	Granular activated carbon
l.q.	Limit of quantification
MISO	Operational safety device
PID	Photoionization detector
PLC	Programmable logic controller
SVE	Soil Vapour Extraction
VOC	Volatile organic compound

## 1. Contact details - CASE STUDY: SVE n.16

<b>1.1 Name and Surname</b>	Confalonieri Massimiliano
<b>1.2 Country/Jurisdiction</b>	Italy
<b>1.3 Organisation</b>	Agenzia Regionale per la Protezione dell'Ambiente (ARPA) della Lombardia
<b>1.4 Position</b>	Dirigente RUO BARAE
<b>1.5 Duties</b>	
<b>1.6 Email address</b>	<a href="mailto:m.confalonieri@arpalombardia.it">m.confalonieri@arpalombardia.it</a>
<b>1.7 Phone number</b>	+39 335 531 8045

## 2. Site background

### 2.1 History of the site

The area in question coincides with a discontinued fuel point of sale (classified as an unhealthy 2nd class industry pursuant to the Municipal Hygiene Regulations), located along Via Lorenteggio in Milan in a city context with mixed tertiary, commercial and residential use.

The site is identified by map 18 of Sheet 505 of the NCT of the Municipality of Milan.

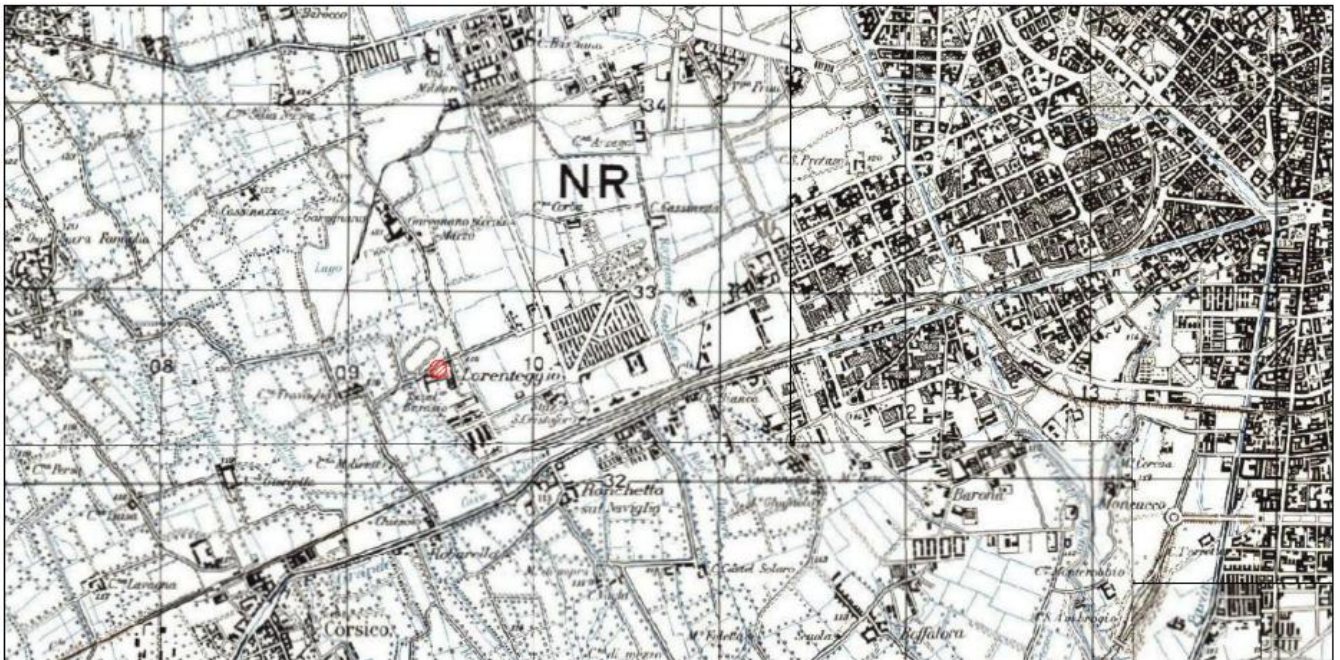

The site does not fall within the perimeter of a SIN and is not affected by any protocols stipulated with the PA.

The plant was located in an area owned by a third party, used with a lease agreement and with the obligation to return it to the owner upon definitive cessation of the activity.

Currently, after the characterization and implementation of the remediation work (not yet completed), the site - after being returned to the property owner- looks like an entirely asphalted area equipped with a public car park at ground level.

The commercial settlement in question, following the temporary cessation of the sale of fuels requested by the managing oil company (with a note dated 03/24/2011) approved by the Municipality of Milan (with note prot. 266874/2011 of the Ufficio Carburanti del Settore Attuazione Mobilità e Trasporti), ceased all activities in 2011.

The site was therefore subject to cleaning and inerting the tank fleet, with interventions



carried out in April 2011.

Subsequently, in application of municipal regulations, the site was the subject of a preliminary environmental investigation campaign carried out in conjunction with ARPA. The results of this preliminary environmental check have shown that the reference CSCs have been exceeded and initiated the procedure pursuant to Title V, which saw the presentation, approval and execution of the Characterization Plan as a first step.



## 2.2 Geological setting

The stratigraphy of the site reconstructed with the surveys delineates a soil of mainly sandy matrix. In detail, the lithological sequence found can be summarized as follows:

- mixed material - Mixed material, essentially consisting of medium sand with the presence of gravel and pebbles that extends from 0 m from ground level about 2 m from ground level;
- silty sand and sand with gravel - fluvioglacial alluvial deposit consisting of alternating levels of silty sand and sand with gravel, extending from 2 m from ground level to 16 m from ground level.

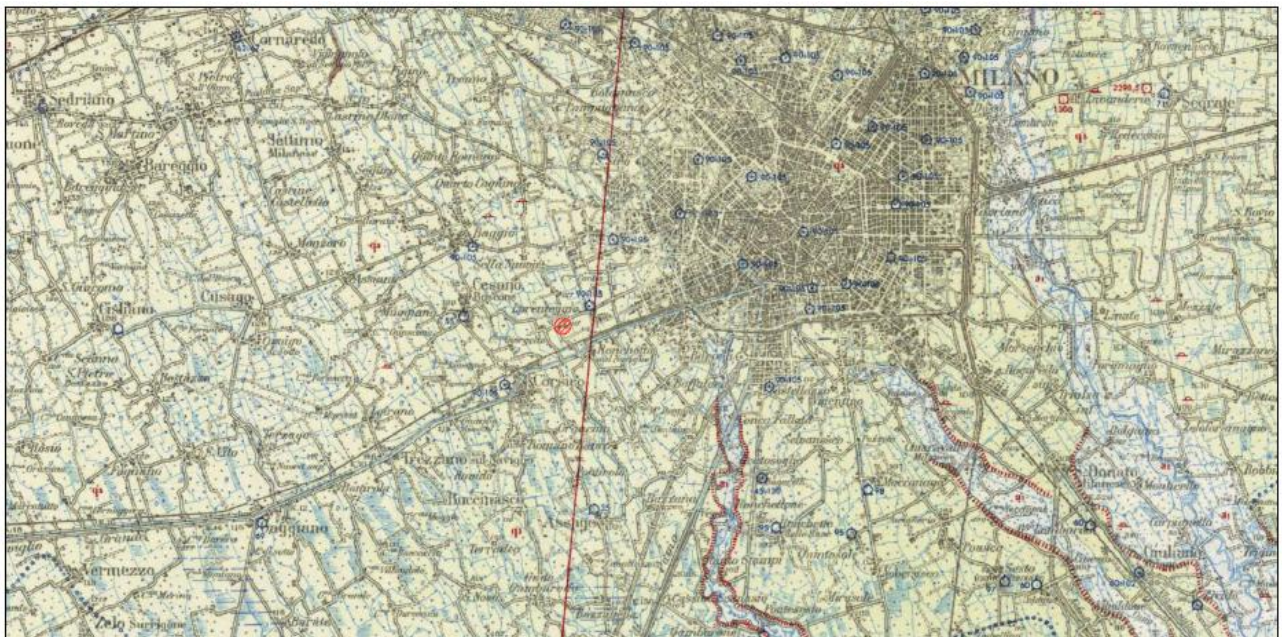

The environmental characterization survey carried out made it possible to identify a free aquifer with high permeability, contained within the alluvial deposit with gravels. The measurements of the piezometric levels performed during the characterization phase indicate an average groundwater depth of about 8.00 m from the p.c., i.e. a water table level that is around 109 m a.s.l.

Over time, the phreatometric checks carried out during the groundwater monitoring campaigns have highlighted the persistence of constant conditions in the direction of flow and periodic variations in the subsidence in a range of about 2 m.

The level measurements, together with the data deriving from the altimetry survey,

made it possible to reconstruct during the characterization phase the trend of the water table, which shows a prevailing flow direction towards ESE and an average hydraulic gradient of approximately 0.16 %.

The direction of flow of the water table was always confirmed by the phreatometric data acquired during the monitoring carried out on the site.

The average transmissivity of the aquifer calculated on the basis of the Pilot Tests described below equals to  $0.1 \text{ m}^2/\text{sec}$ .

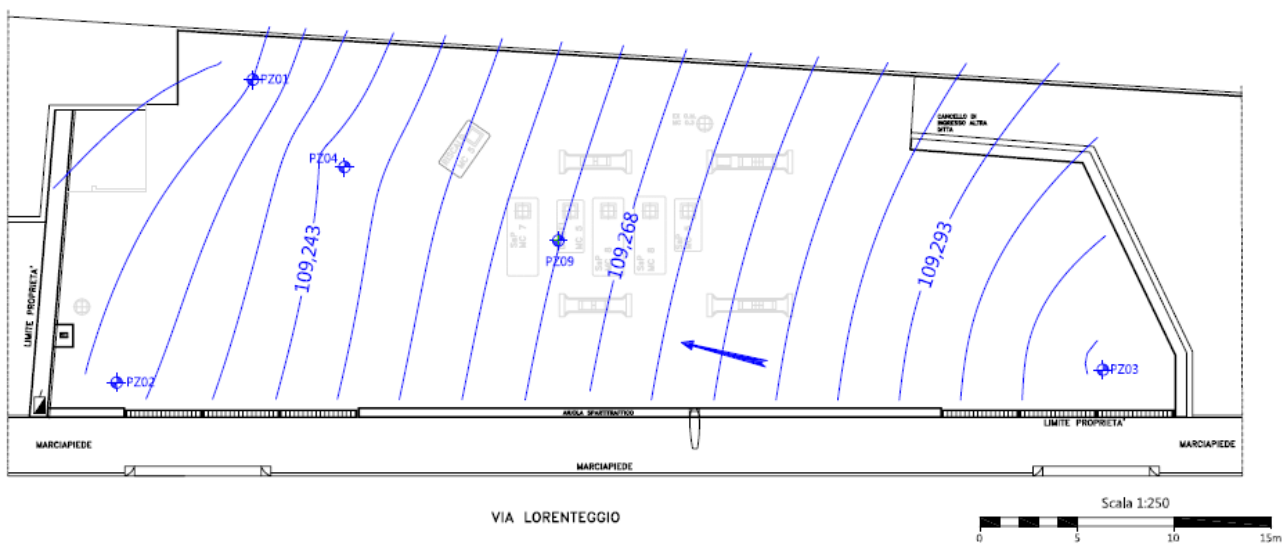

The contamination detected was in the deep soil (SP), starting from the level of the basement level of the underground tanks (about 4 - 5 m from the local p.c.); the local water table was also contaminated.

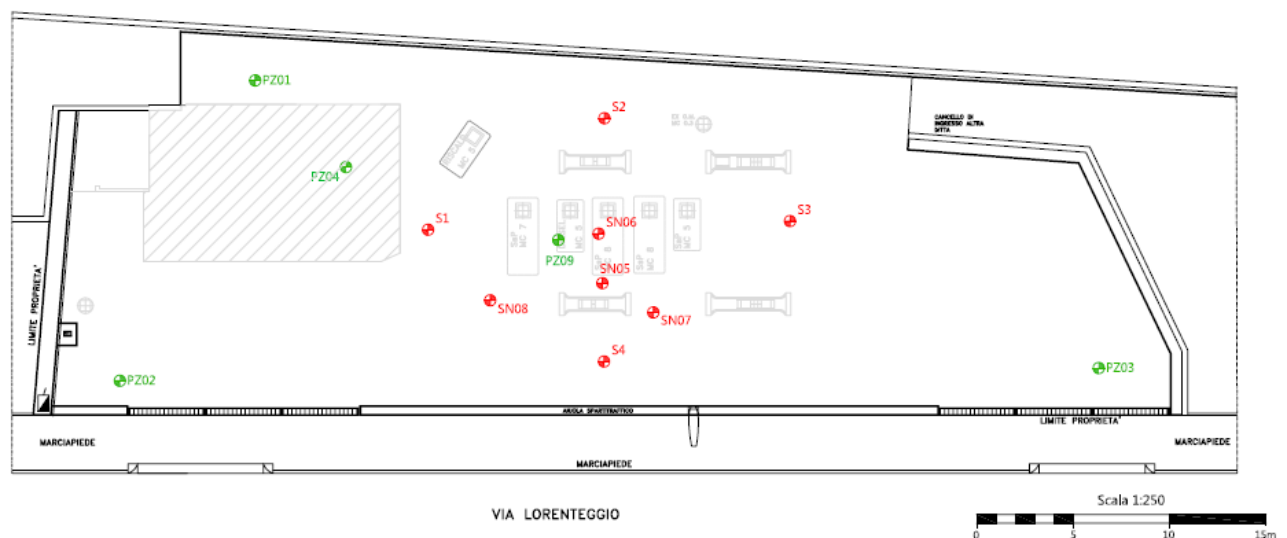



## 2.3 Contaminants of concern

The preliminary environmental investigation phase (IA), carried out at the same time as the removal of the tank park, concerned: walls and bottom of the excavation resulting in the removal of existing tanks on site, bottom of the resulting excavation after the removal of a small tank for the storage of used oils.

Analytical tests were carried out on the samples taken, aimed at determining the concentration values of heavy and light hydrocarbons (C <12 and C 12 - 40), IPA, BTEXS, Pb and MTBE.

The results of the analytical assessments were compared with the acceptability limits (CSC) set by current legislation (in particular table 1, column A of annex 5 to title V of part IV of Legislative Decree 152/06 and subsequent amendments and additions, considering that the area in question will be returned to the property once the decommissioning of the PV is completed) for the quality of the soil/subsoil matrix with respect to possible contamination.

The results of the control analyzes carried out by ARPA showed the presence of exceedances of the CSCs in particular for petroleum hydrocarbons (C > 12).

This evidence led to the continuation of the proceedings pursuant to Title V of Part IV of Legislative Decree 152/06, the communication of which was made in advance by the obliged party pursuant to art. 249 of the same Legislative Decree 152/06.

The site was therefore the subject of a Characterization Plan assessed and approved during the dedicated Services Conference and subsequently authorized by the Municipality of Milan with the PG 790255/2012 deed of 04/12/2012.

The results of the characterization showed that the reference CSCs were exceeded (col. A of Tab. 1 of annex 5 to Title V of part IV of Legislative Decree 152/06) for parameters C <12, C > 12, BTEXS (benzene, toluene, xylenes, ethylbenzene) in the unsaturated soil matrix and for the parameters (Tab. 2 of Annex 5 to Title V of Part IV of Legislative Decree 152/06) total hydrocarbons n-hexane, benzene, xylenes in addition to MtBE and EtBE (with reference to the values indicated by ISS, used at the time, not being regulated at that date) for the local groundwater matrix.

Pending the continuation of the procedure, an intervention by MISE was activated, implemented through a system for the extraction of water from the local groundwater (the discharged water was initially collected and disposed of as liquid waste, awaiting authorization from the competent authority to discharge it into the public sewer system).

The obliged subject therefore presented (pursuant to Article 242 and following, as



Ministerial Decree 32/2015 was not yet in force) a risk analysis report and related remediation project to be implemented with the simultaneous intervention on the groundwater matrix (by P&T) and on unsaturated soil/subsoil (by SVE and AS). The risk analysis and remediation interventions were evaluated and approved in the Services Conference and then authorized by the Municipality of Milan.

## 2.4 Regulatory framework

- “Linee Guida Serbatoi Interrati” ARPA - Lombardy, Milan - April 2004;
- Law 9 December 1998, n. 426;
- Legislative Decree 11 February 1998, n. 32;
- Legislative Decree 3 April 2006, n. 152 "Norme in materia ambientale";
- Legislative Decree 16 January 2008, n. 4 “Ulteriori disposizioni correttive ed integrative del decreto legislativo 3 aprile 2006, n. 152 ”;
- Law 28 January 2009, n. 2;
- Legislative Decree 3 December 2010, n. 205";
- Law 9 August 2013 n. 98;
- DM 31/2015
- D.G.R. Lombardy 10 February 2010 n. 8/11348;
- ISPRA (formerly APAT), October 2010 "Protocollo ISPRA-INAIL (ex-ISPEL) per la valutazione del rischio associato all’inalazione di vapori e polveri, in ambienti aperti e confinati nei siti di bonifica – Rev.0";
- ISPRA (formerly APAT), June 2009 "Appendice V – Applicazione dell’Analisi di Rischio ai Punti Vendita Carburante ai Criteri metodologici per l’applicazione dell’analisi assoluta di rischio ai siti contaminati" (Appendix V);
- ISS/ISPEL database (update 2018);
- ASTM E2081-00 (2004), “Standard Guide for Risk-Based Corrective Action”, ASTM International
- APAT, June 2008 "Documento di riferimento per la determinazione e la validazione dei parametri sito-specifici utilizzati nell’applicazione dell’analisi di rischio ai sensi del D.Lgs. 152/06";
- APAT, March 2008 "Criteri metodologici per l’applicazione dell’analisi assoluta di rischio ai siti contaminati rev. 2".



## 3. Pilot-scale application in field

### 3.1 Extraction system

The remediation approach involved the application of a Pump and treat (P&T) intervention on groundwater (with subsequent reintroduction in the hydrogeological upstream groundwater) and a joint intervention of air sparging (AS) and soil vapour extraction (SVE) on unsaturated soil.



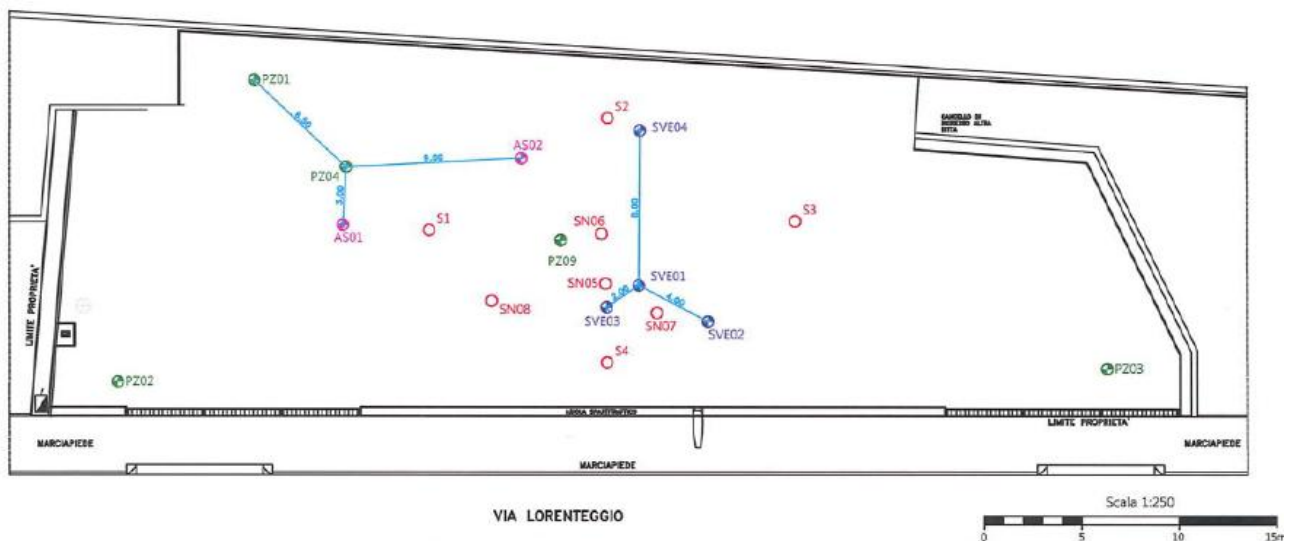

In order to assess the applicability of the AS (Air Sparging) technologies for the aquifer and SVE (Soil Vapour Extraction) for the unsaturated soil to the site under examination, pilot tests of AS and SVE were performed.

These results showed that neither the introduction of air into the groundwater nor the extraction of air from the subsoil have significant effects on groundwater levels at the design flow rates of the plant.

On the scale of the pilot test, n. 4 points for the execution of the Soil Vapour Extraction test were prepared by core destruction perforation and pushed to a depth of 6 m from the local p.c., then equipped with 2" PVC piping.



#### LEGENDA

-  Sondaggi realizzati per la caratterizzazione ambientale del sito
-  Piezometri realizzati per la caratterizzazione ambientale del sito
-  Punti di Air Sparging da realizzare
-  Punti di SVE da realizzare

In order to assess the applicability of the SVE technology to the site in question and determine the range of action induced in the ground by the suction of air, a step test was conducted by placing a point in suction and using other wells as monitoring points.



## 3.2 Injection system

In the pilot scale application, specially drilled wells were used (boreholes pushed up to 6 m from the local p.c., equipped with a 2" PVC pipe) and the carrier gas used was atmospheric air (the same then used at the real scale).

### 3.3 Radius of influence

In the pilot scale application, a step test was carried out, placing the SV01 point in suction with increasing flow rate steps and using points SV02, SV03 and SV04 as monitoring points.

The extraction and blowing system used a dry vane compressor. For the treatment of interstitial vapours extracted from the subsoil, activated carbon cartridges for air were used.

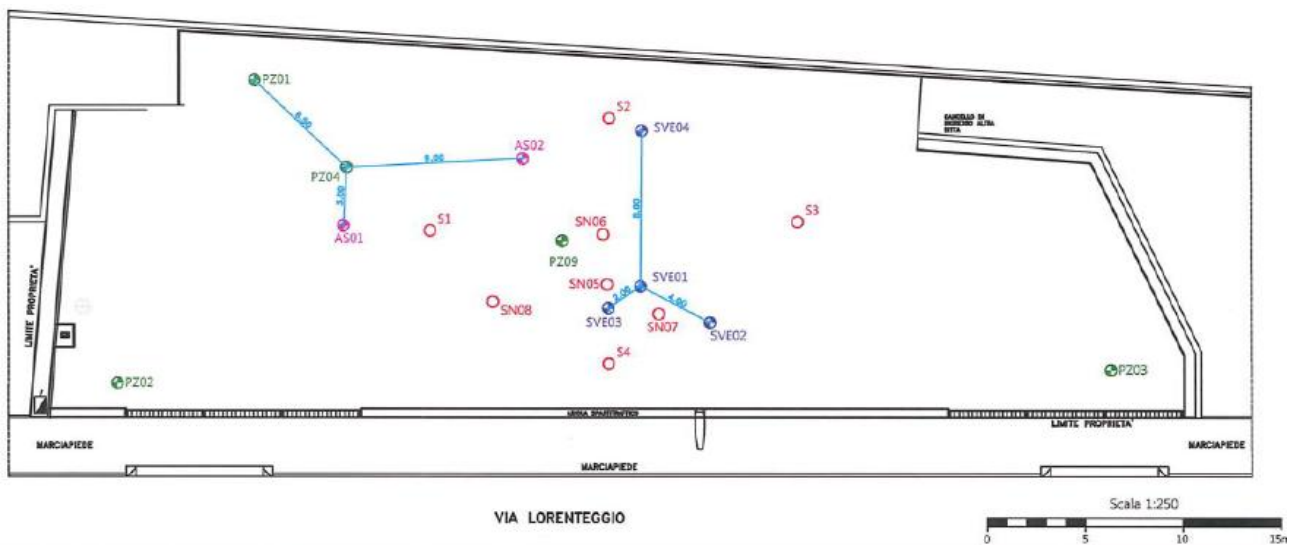

The extraction of unsaturated air at point SV01 induced, at the maximum flow rate used ( $80 \text{ m}^3/\text{h}$ ), a depression of the order of 15 mbar at the suction point and a maximum of 0.3 mbar in the SV02 located 4 m from the extraction point.

As the extraction rate varied, there was a sharp increase in the amount of Volatile Organic Compounds (VOCs) extracted from point SV01, with maximum values of the order of 300 ppm.

Considering, in accordance with the industry guidelines, the value of 0.25 mbar as the minimum significant depression to have an influence on the suction side, it is possible to establish a range of action of the SVE, at the maximum tested flow rate, between 2 and 3 m.

In order to verify the applicability of the AS technology to the site under examination, determine its range of action and verify the combined effect AS + SVE, a step test was carried out to blow air inside point AS01, using points SV02, SV03, SV04, AS02, PZ04 and PZ01 to monitor the test parameters. In the combined test point SV01 was placed under





suction, with a constant flow rate and set by determining the flow rate steps of the air introduced in point AS01.

A second test carried out on AS and SVE kept the flow of air extracted from point SV03 constant, while in connection with point AS01, flow rate steps of injected air were set.

At the end of the SVE tests, exploiting the oxygenation of the soil induced by the recall of air, a BV test was performed by monitoring the indicator parameters of any possible bacterial activity capable of decomposing the hydrocarbon components.

The parameters used for the dimensioning of the SVE system were chosen according to the results of the pilot test, which can be summarized as follows:

- Calculated radius of influence, ROI: 2.7 m from the vapour extraction point;
- Depression applied to each point SVE, PEa: from -10 to -20 mbar;
- Extraction rate for each SVE point, QEa: about 70 Nm<sup>3</sup>/h.

From the results of the pilot tests and from the definition of the Conceptual Model of the site, the parameters for calculating the duration of the remediation were defined:

- Extraction rate for each SVE point, QEa: about 70 Nm<sup>3</sup>/h;
- Air inlet pressure at each point AS: QIa: about 300 mbar Nm<sup>3</sup>/h;
- VOC concentration entering the remediation system, Ci: 430 mg/Nm<sup>3</sup>;
- Estimated volume of the source of contamination, V: 800 m<sup>3</sup>;
- Concentration of contaminants in the source of contamination, Cc: 8802 mg/kg.

The overall duration of the reclamation of the subsoil was estimated in the project in the order of 3 years.

### **3.4 Off gas Treatment**

For the pilot plant, a capture system was used consisting of activated carbon cartridges, which were then disposed of (code EER 19.13.02).

### 3.5 Control parameters

The pilot scale monitoring and sampling plan evaluated the concentration variations of VOCs (volatile organic compounds) using a portable PID photo ionizer and estimated the triggering of bacterial activity in the soil by evaluating the variations of O<sub>2</sub> and CH<sub>4</sub>. To assess full-scale applicability, the following were measured, as the operating flow rates vary:

- extraction flow, depression and VOC concentration on the air extraction line.
- depression and VOC concentration on monitoring points

In the AS and combined AS and SVE test the following were monitored:

- inlet flow rate and pressure on the air inlet line
- extraction flow, depression and VOC concentration on the air extraction line.
- VOC concentration, temperature, dissolved oxygen and groundwater level at the monitoring points during the first test
- depression and VOC concentration on the monitoring points during the second test

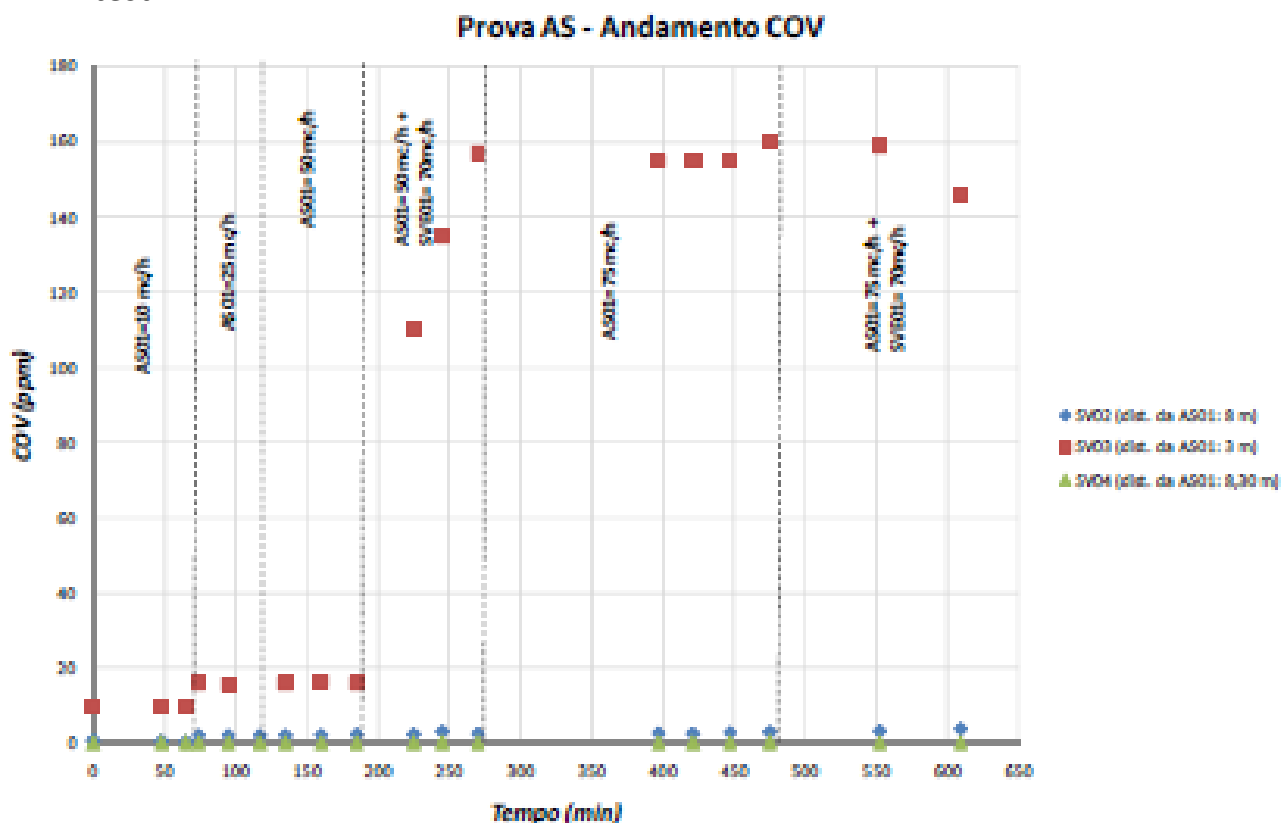

First test results

### Prova combinata AS-SVE

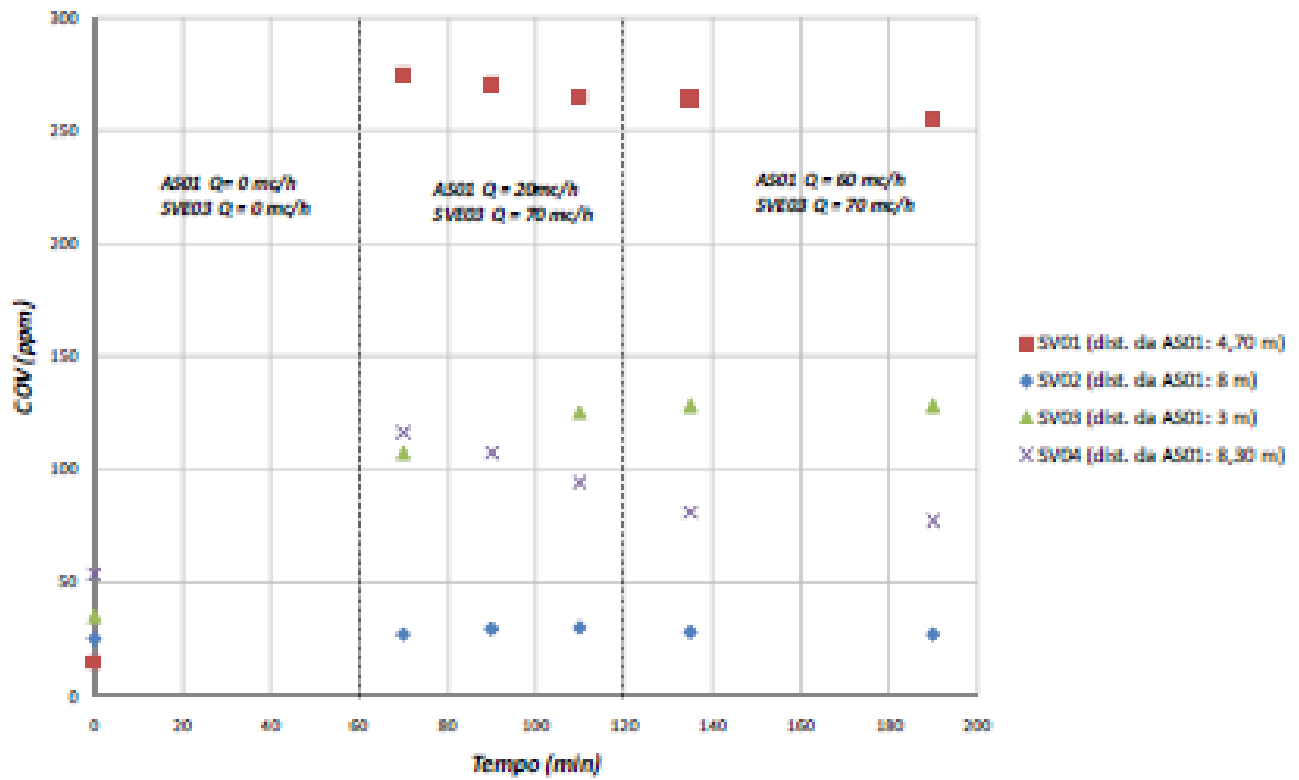

Second test results

## 4. Full-scale application

### 4.1 Extraction system

The number, spatial location, and construction characteristics of the vapour extraction points were defined in consideration of the ROI determined through the pilot tests, the areal and vertical distribution of the contamination, without neglecting the litho-stratigraphic structure of the site.

The parameters used for the dimensioning of the SVE system were chosen according to the results obtained from the pilot test; in particular, the following project parameters were assumed:

- Calculated radius of influence, ROI: 2.7 m from the vapour extraction point;
- Depression applied to each SVE point, PEa: from -10 to -20mbar;
- Extraction rate for each SVE point, QEa: about 70 Nm<sup>3</sup>/h.

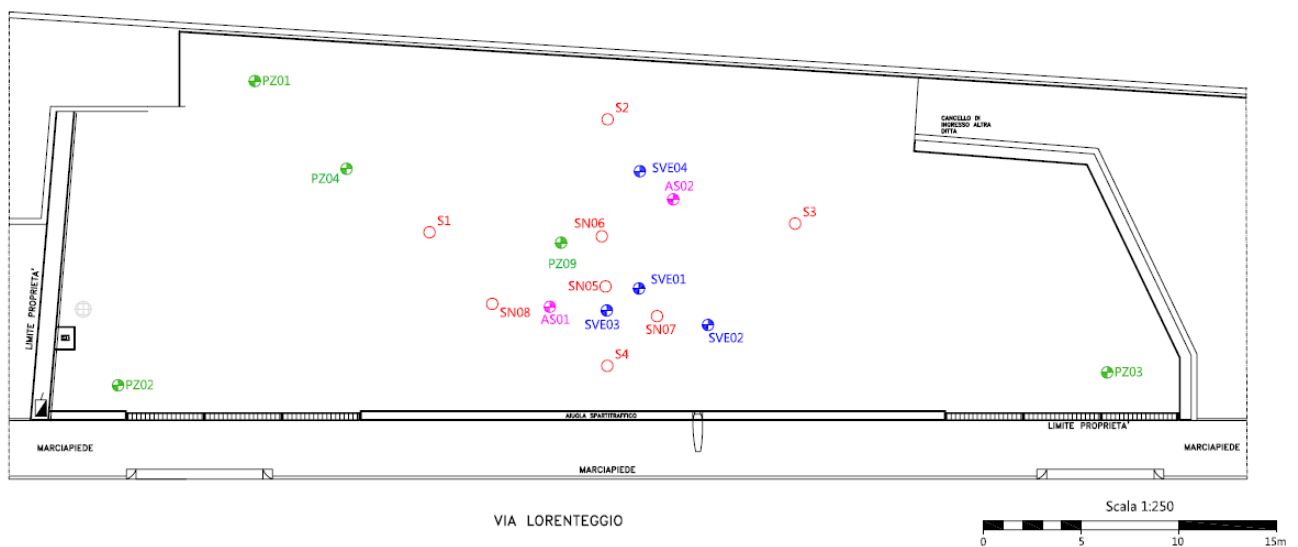

The vapour extraction system consists of 10 points, all made by means of core destruction drilling, with the housing in the sounding hole of a non-toxic PVC pipe with a diameter of 2", installed at a maximum depth of 9 m from the ground level (in particular, some SVE wells were built up to 9 m deep and with a filter section between 7 and 9 m from the local ground level; some SVE wells pushed up to 7 m deep and with a filter section between 5 and 7 m from the local ground level; some SVE wells pushed up to 4 m deep and with a filter section between 2 and 4 m from the local ground level).

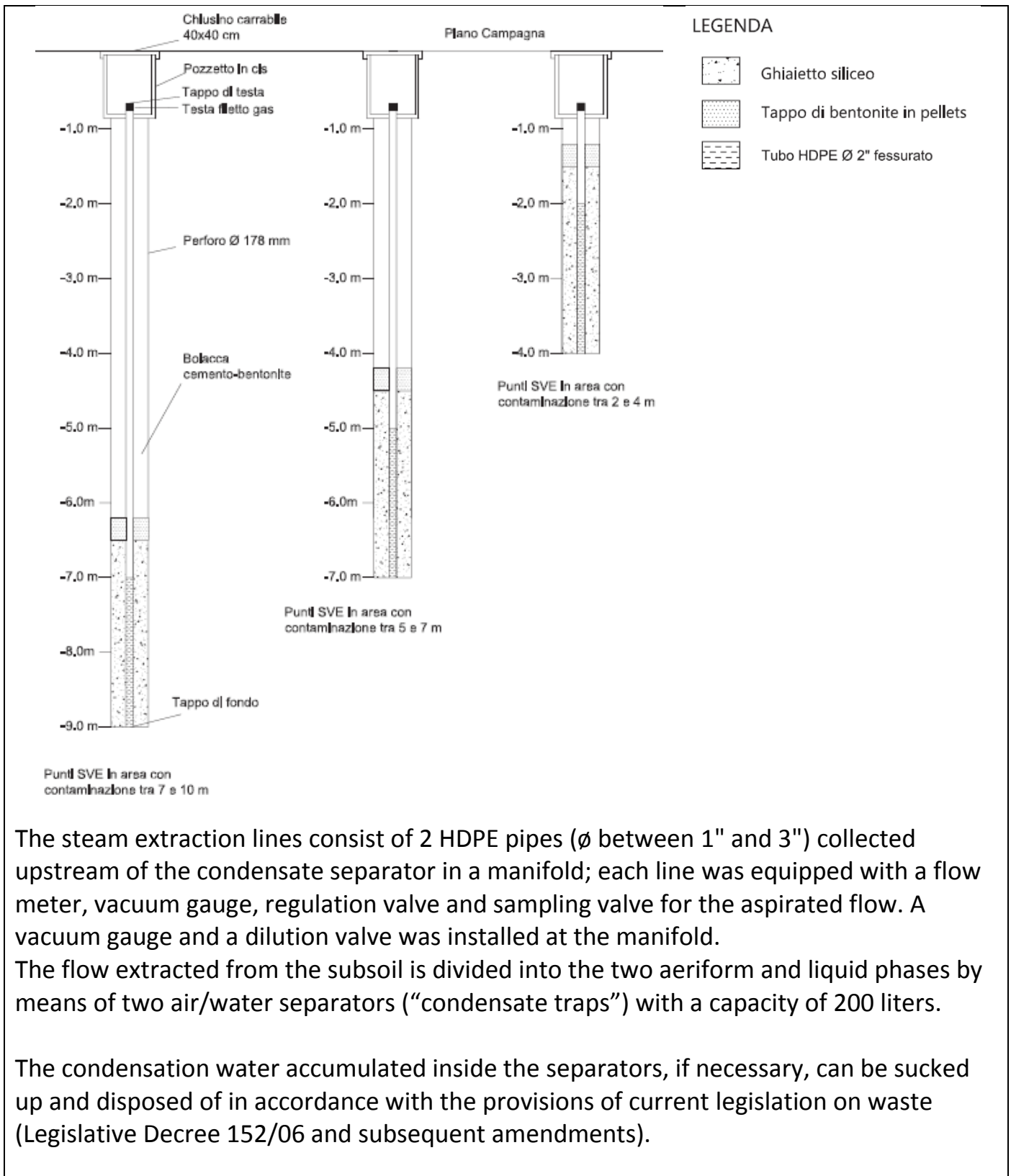

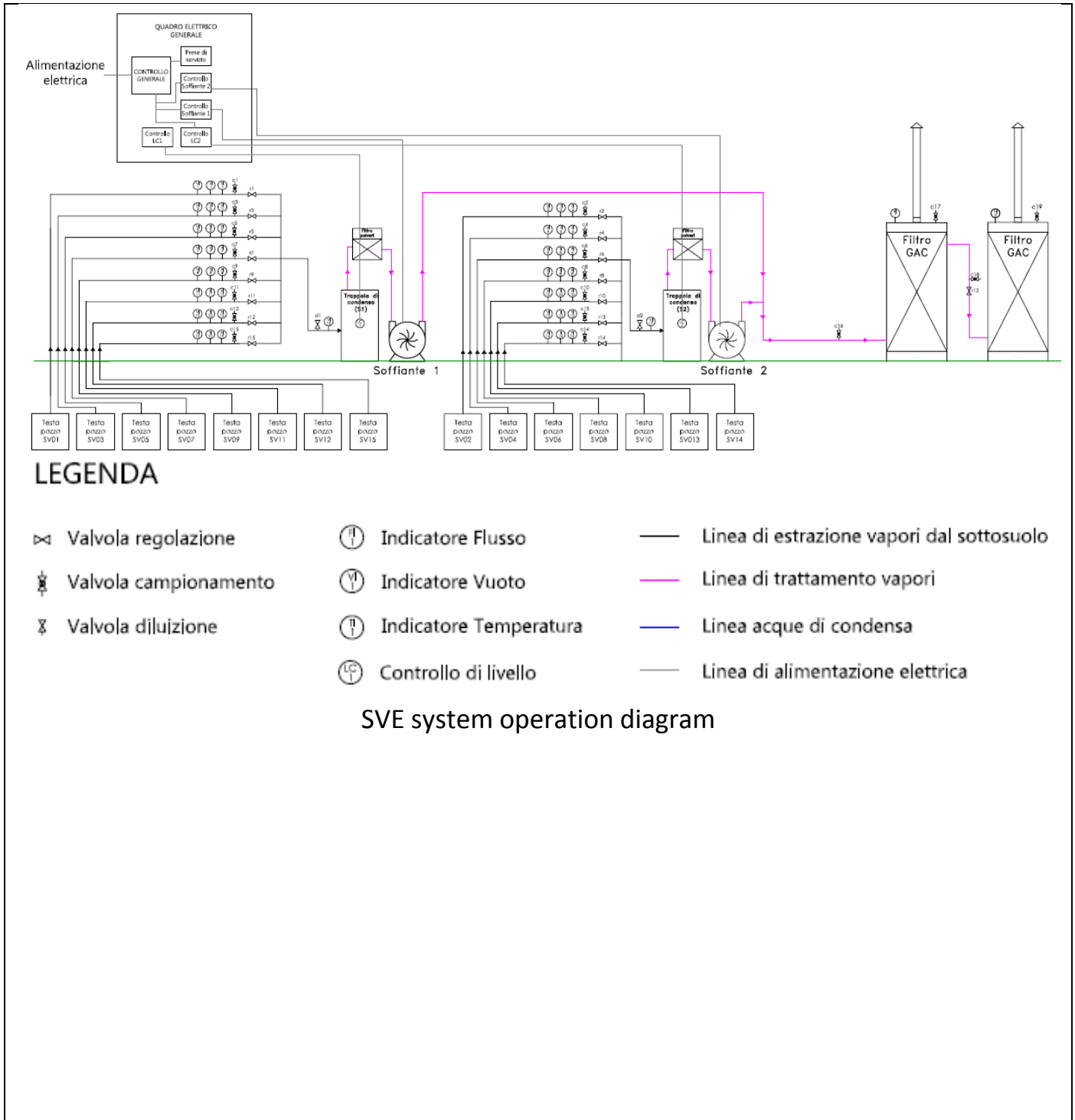

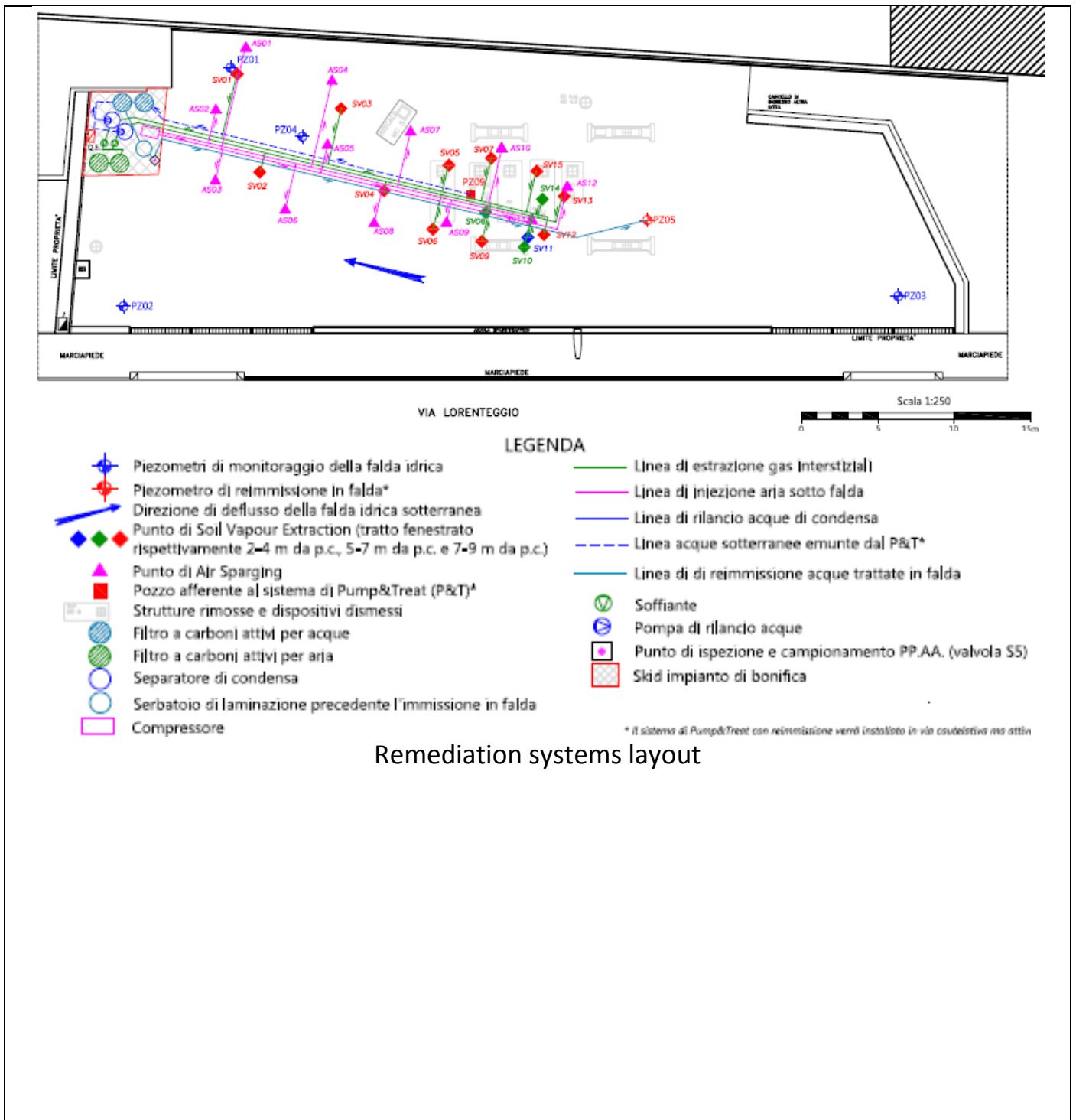

Remediation systems layout





## 4.2 Injection system

In the full-scale application, atmospheric air was used as a carrier gas and the system was built with the installation of n. 10 SVE wells.

The ventilation system has provided for the installation of 2 side channel blowers (regenerative blower), by means of which to induce a depression in correspondence with the vapour extraction wells created/positioned in order to treat specific portions of unsaturated subsoil, favouring the desorption of the contaminants from the solid phase to the gas phase.

The criterion underlying the design choice to use two blowers was based on the opportunity to alternate the steam extraction points on two separate lines, allowing some flexibility in managing the system and letting it operate during partial maintenance.

In particular:

- BLOWER 1 - afferent to 8 steam extraction points, capable of reaching a depression between -200/-250 mbar, for a total flow rate of approximately 560 Nm<sup>3</sup>/h, in order to guarantee an equal air flow for each extraction point at about 70 Nm<sup>3</sup>/h;
- BLOWER 2 - afferent to 7 steam extraction points, able to reach a depression between -200/-250 mbar, for a total flow rate of about 500 Nm<sup>3</sup>/h, so as to guarantee an equal air flow for each extraction point at approximately 70 Nm<sup>3</sup>/h.

The blowers, each connected to a group of suction points, work individually alternately according to on/off cycles controlled by a timer.

## 4.3 Radius of influence

The operating range of influence used in the project was assumed to be equal to the ROI obtained from the pilot tests, i.e. 2.7 meters for each single ventilation point.



## 4.4 Off gas Treatment

The vapours extracted from the subsoil have been collected and conveyed to condensate traps, where the separation between the interstitial gas and any water vapour present in the extracted air flow takes place; the condensate water is removed from the separators by means of special booster pumps and sent to a water treatment system before being discharged into the sewer system.

The interstitial vapour, once dehumidified, passes through an anti-particulate filter before passing through the blower that generated the vacuum and only then is sent to the air handling unit.

To reduce the pollutants present in the extracted interstitial gases, a pair of filters in series with granular activated carbon was installed.

The treatment unit has also been provided with arrangements that allow the filters to be arranged in parallel in the event that the inlet flow shows compatible VOC concentrations.

The exhaustion time of the activated carbons used for the treatment of interstitial gases, estimated on the basis of very conservative theoretical calculations, was set in the project as approximately 87 days and was verified with the results of the analyzes carried out on the outgoing air samples from the plant from the respective plants.

This check made it possible to program the replacement of the carbon pack of the filters according to the actual site-specific conditions.



## 4.5 Control parameters

To evaluate the effectiveness of the SVE intervention in the three dimensions, checks were carried out during the start-up phase of the plants and subsequently with periodic checks.

The reclamation plant and the state of the sites were periodically subject to visits aimed at:

- verify the correct functioning of the systems;
- perform routine maintenance of the system;
- schedule any extraordinary maintenance interventions;
- monitor the operating parameters of the plant and possibly remodel the adjustments;
- check the quality of the flows entering and leaving the water and air treatment system.

Before starting the plant, or at  $T_0$ , a complete monitoring of the groundwater was carried out, with detection of the static piezometric level and measurement of the chemical/physical parameters with particular attention to dissolved oxygen values.

At the first start-up of the SVE/AS plant, the appropriate adjustments were made on the operating parameters (extracted/injected flows, pressures/depressions, etc.) and the simultaneous monitoring of the subsoil response (concentration of VOC -  $O_2$  -  $CO_2$  in the interstitial vapours, induced elevations in the aquifer, dissolved oxygen levels in groundwater, etc.) and the efficiency of the treatment systems.

During the setting up, the following measurements were therefore carried out every 2 days:

- relief of depressions in the vapour extraction points and on the manifold;
- survey of the VOC concentrations and the volumetric percentages of  $O_2$  and  $CO_2$  in the vapour extraction points;
- survey of the concentrations of VOCs entering and leaving the air treatment system;
- measurement of extracted flow and injection rates;
- pressure relief at the injection points;
- piezometric survey in correspondence with all wells/piezometers installed on-site;
- measurement of chemical-physical parameters with particular reference to dissolved oxygen (OD).



The set-up took about 10 days and ended with the testing of the air treatment system by sampling and laboratory analysis of the vapours entering and leaving the system.

The above analytical results allowed to validate the use of the portable photo ionizer (hereinafter PID) as a subsequent tool for controlling the quality of the effluent.

Check-ups were carried out on a monthly basis on the system in order to verify the correct functioning of the system and monitor the operating parameters of the system (extraction/injection flow rates, pressures/depressions, VOC - O<sub>2</sub> - CO<sub>2</sub> concentration in the interstitial vapours, OD concentration in groundwater, piezometric levels, etc.) making any new adjustments if necessary.

During operation, routine maintenance of the plant parts was performed (filter cleaning, etc.) and, if necessary, extraordinary maintenance (replacement of activated carbon, waste disposal, etc.).

On an annual basis, samples were taken from an absorber vial to be sent to the laboratory to analyze the gaseous flow in and out of the air treatment system.



## 6. Post treatment and/or Long Term Monitoring

### 6.1 Post treatment and/or Long Term Monitoring

Following the injection of atmospheric air into the saturated subsoil and the ventilation of the vadose portion, mobilization and removal of the volatile organic compounds present and oxygenation of the subsoil were obtained.

The increased availability of oxygen favours the aerobic biodegradation processes of hydrocarbons.

For this purpose, periodic respirometric test campaigns (every six months) were carried out during operation, which consists of monitoring the oxygen and carbon dioxide concentrations for a sufficiently long period of time (48 hours) after the shutdown of the systems' ventilation, in order to evaluate aerobic activity in the unsaturated subsoil.

In practice, once the system is turned off, the oxygen present in the interstitial gases will tend to be consumed more rapidly the greater the aerobic biological activity present. On the contrary, the concentrations of carbon dioxide will tend to increase more rapidly the more intense the aerobic biodegradative activity is in place.

On the basis of the data collected, it is possible to estimate average biodegradation rates of contaminants per soil mass in the unit of time.

A soil gas control network has not been envisaged on the site, whose proceedings began before the issuance of the Ministerial Decree 31/2015 and the National Guidelines (LG SNPA) on the soil gas matrix.

## 7. Additional information

### 7.2 Additional information

The project goal of the site remediation was indicated as definitively achieved when the concentrations of pollutant compounds adsorbed to the deep soil and dissolved in groundwater reach the relative CSR values set out in the following tables:

**Tabella 1.** Obiettivi di bonifica per suolo e sottosuolo

Sostanza indicatrice	u.m.	Obiettivi di bonifica
Piombo	mg/kg	100 <sup>(1)</sup>
Benzene	mg/kg	0,29 <sup>(2)</sup>
Etilbenzene	mg/kg	0,94 <sup>(2)</sup>
Stirene	mg/kg	0,5 <sup>(1)</sup>
Toluene	mg/kg	0,5 <sup>(1)</sup>
Xilene	mg/kg	30,24 <sup>(2)</sup>
Sommatoria organici aromatici (da 20 a 23)	mg/kg	1 <sup>(1)</sup>
Idrocarburi Leggeri C ≤ 12	mg/kg	60,8 <sup>(2)</sup>
Idrocarburi Pesanti C > 12	mg/kg	117,7 <sup>(2)</sup>
Piombo Tetraetile	mg/kg	0,01 <sup>(3)</sup>
MTBE	mg/kg	10 <sup>(4)</sup>
ETBE	mg/kg	10 <sup>(4)</sup>

(1) colonna A (siti ad uso verde pubblico, privato e residenziale) Tabella 1 dell'Allegato 5 Titolo V Parte Quarta del D.Lgs. 152/06 (CSC per i terreni)

(2) CSR approvate con Determina Dirigenziale Comune di Milano n. 596/152 del 24 novembre 2014

(3) parere ISS del 17/12/2002 n. 49759 IA.12

(4) parere ISS del 2001 n. 57058 IA/12

**Tabella 2.** Obiettivi di bonifica per le acque sotterranee

Sostanza indicatrice	u.m.	Obiettivi di bonifica
Benzene	µg/l	1 <sup>(1)</sup>
p-Xilene	µg/l	10 <sup>(1)</sup>
Idrocarburi Totali (espressi come n-esano)	µg/l	350 <sup>(1)</sup>
MTBE	µg/l	40 <sup>(2)</sup>
ETBE	µg/l	40 <sup>(2)</sup>

(1) CSC di cui alla Tabella 2 dell'Allegato 5 al Titolo V, Parte Quarta del D.Lgs. 152/06 come riportato nella Determina Dirigenziale Comune di Milano n. 596/152 del 24 novembre 2014

(2) Parere ISS del 12/09/2006 N. 45848, come riportato nella Determina Dirigenziale Comune di Milano n. 596/152 del 24 novembre 2014

**Tabella 3.** Ulteriori sostanze monitorate per le acque sotterranee

Sostanza indicatrice	u.m.	Obiettivi di bonifica
Piombo	µg/l	10 <sup>(1)</sup>
Etilbenzene	µg/l	50 <sup>(1)</sup>
Stirene	µg/l	25 <sup>(1)</sup>
Toluene	µg/l	15 <sup>(1)</sup>
Piombo tetraetile	µg/l	0,1 <sup>(2)</sup>

(1) CSC di cui alla Tabella 2 dell'Allegato 5 al Titolo V, Parte Quarta del D.Lgs. 152/06

(2) Parere ISS 17/12/2002 n. 49759 IA.12

The project envisaged that the remediation testing would be required when, for three subsequent monitoring, compliance with the remediation objectives for groundwater determined by the Site-Specific Risk Analysis and Compliance (CSC) was found at the PoC and at the same time the SVE plant had extracted zero VOC concentrations for a period of at least 3 months.

Upon verification of the above conditions, 3 monthly on/off cycles of the groundwater reclamation and sampling plants were carried out.

Following the positive outcome of the three monitoring sessions carried out in the shutdown cycles, the shutdown of the plants and the subsequent testing of the deep soil matrix was envisaged. It was proposed to carry out some probes with sampling of unsaturated matrix for verification of compliance with the CSRs defined by the risk analysis.

From the end of June 2018 to the end of July 2018, when the remediation systems were shut down, the SVE plant extracted an average flow rate of interstitial gases from the subsoil equal to about 12,000 m<sup>3</sup>/day.

In the same period, the AS plant, by means of a side-channel compressor, had blown atmospheric air into the saturated subsoil with an operating pressure of about 0.3 bar and an average flow rate of 240 m<sup>3</sup>/h.

From August to October 2018, the SVE and AS plants operated intermittently to allow the implementation of the reclamation test plan.

The duration of the reclamation of the subsoil was estimated at about 3 years, with the start-up of the plants on 27 July 2015. The operation of the reclamation plants ended in July 2018.

In the subsequent period up to January 2019, the testing activities of the environmental matrices of the subsoil were carried out. These showed compliance with the remediation objectives for groundwater and unsaturated soils in the south-east sector of the site, with the exception of the area central of the site where residual





concentrations of heavy hydrocarbons C> 12 persisted.

The checks carried out on the groundwater matrix, on the other hand, showed compliance with the CSCs of reference to the POC of the site (this situation was verified over time through the monitoring of the groundwater).

The outcome of the testing on unsaturated soil, implemented as per the approved test plan, therefore highlighted the persistence of values exceeding the established remediation objectives.

The analyses carried out by the ARPA Laboratory, on the samples taken in contradiction, show the failure to achieve the remediation objectives for the hydrocarbon parameter C> 12 in a sample taken in the depth range between 5 and 6 m from the local p.c. (the ARPA Laboratory quantifies a value of 458 mg/kg dry matter, compared to the remediation target set at 117.7 mg/kg, as defined by the reference CSR).

Similarly, the Party's data shows the non-compliance with the remediation objectives for the hydrocarbon parameter C> 12 only in two samples taken both in the same vertical survey verified by ARPA, one between 3 and 4 m deep from the local p.c. (with 880 mg/kg, compared to the CSR of 117.7 mg/kg) and one between 5 and 6 m of depth from the local p.c. (with 300 mg/kg, compared to the CSR of 117.7 mg/kg).

The checks were carried out after the period of operation of the reclamation plant in unsaturated soil. The south-east sector of the former PV shows the achievement of concentrations lower than the reclamation objectives, while in the center of the site, residual concentrations were determined in Heavy hydrocarbons C> 12 exceeding the CSR, distributed between the depths of 3 and 7.5 m from p.c..

The almost zero values of the VOCs measured in the interstitial gases extracted from the unsaturated subsoil with the SVE plant and the weak biodegradative activity determined with the respirometric test showed that the remediation systems, consisting of an SVE, AS and P&T plant, have exhausted their effectiveness in cleaning up contamination.

Faced with this evidence, it was proposed to launch a soil gas monitoring campaign on the site to measure the real flow of volatile substances present in the subsoil in order to apply the measured data as part of a risk analysis review.

For the verification of the real flow coming from the subsoil it was initially proposed to use some of the existing SVE wells for the soil gas monitoring network. In view of the observations made by ARPA (which assessed the dimensions and depths of the filtering sections of the proposed SVE wells as non-compliant with the specifications of the LG SNPA), the installation of 3 soil gas probes of the "nesty probe" was therefore proposed. The monitoring activities of the soil gas matrix, which will be carried out for an annual duration with seasonal campaigns (quarterly sampling), will be used to obtain direct data to be used for a review of the risk analysis.

## 1. Contact details - CASE STUDY: SVE n.17

<b>1.1 Name and Surname</b>	Confalonieri Massimiliano, Panzeri Paola, Canepa Paola
<b>1.2 Country/Jurisdiction</b>	Italy
<b>1.3 Organisation</b>	ARPA Lombardia
<b>1.4 Position</b>	Dirigente RUO BARAE
<b>1.5 Duties</b>	
<b>1.6 Email address</b>	<a href="mailto:m.confalonieri@arpalombardia.it">m.confalonieri@arpalombardia.it</a>
<b>1.7 Phone number</b>	+39 335 531 8045

## 2. Site background

### 2.1 History of the site

The site covered by this questionnaire is known as EX BRENNTAG DEPOSITO and is located in an industrial area north-west of Milan, in the municipality of Bollate.

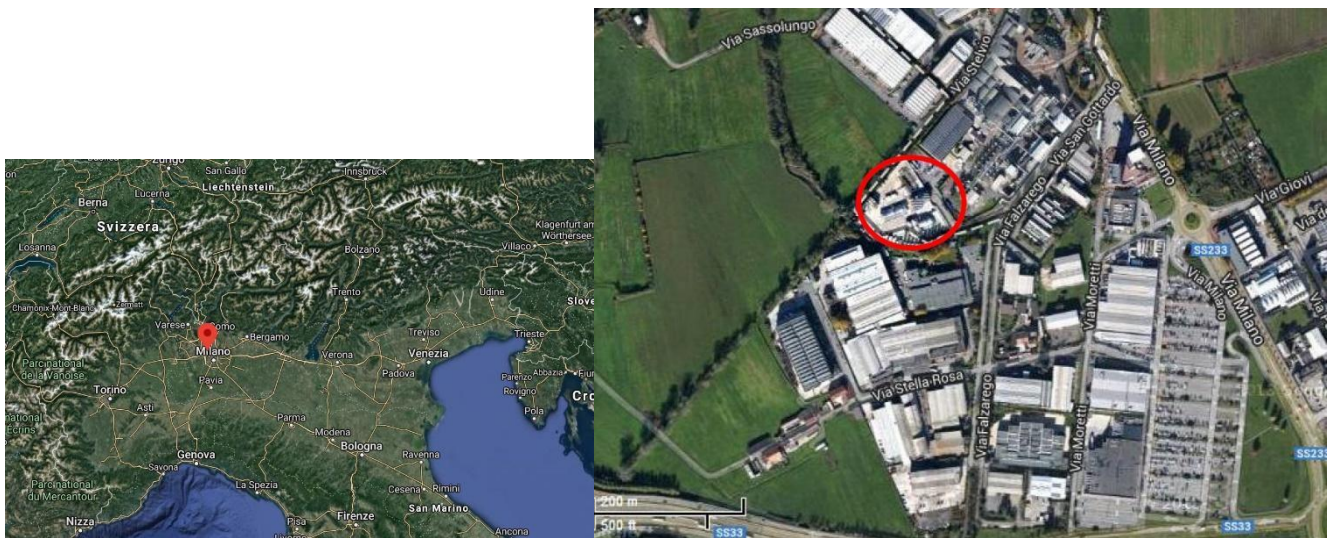

The area is not part of a Site of National Interest.

The company, active since the late 1950s, deals with the storage and distribution, wholesale and retail, of chemical substances and is one of the Industries at Risk of Major Accident subject to Legislative Decree no. 105/2015 called "Seveso III Decree".

The deposit initially covered only a limited part of the current surface and consisted of 10 vertical 30 m<sup>3</sup> above ground tanks, located along the southern border, and 11 (plus 5 installed after a few years) buried tanks of 30 m<sup>3</sup> each. (some of which divided into two compartments), arranged along the western border; all these tanks have now been removed and demolished. From notes of the time, it seems that the products stored were the following:

- Underground tanks: dichloroethane, MEK, Acetone, Ethyl alcohol, Methyl alcohol, Isobutyl acetate, Ethyl acetate, IPA, Heptane, Octane, Toluene, Hexane, Cyclohexane, Trieline, Tetrachloroethane, Sulphuric ether, Solvent naphtha from petroleum, THF, MIBK
- Above Ground Tanks: Ethyl glycol, Butyl glycol, Ethylene Glycol, Propylene Glycol, Propylene Glycol USP, Methyl glycol, Methyl glycol Acetate, Cyclohexanone and Cyclohexanol

The deposit has undergone various modifications over the years; was expanded in 1968



(10 tanks of 50 m<sup>3</sup> above ground), in 1974 (25 tanks of 50 m<sup>3</sup> underground) and in 1985 (7 tanks of 50 m<sup>3</sup> above ground, 6 horizontal tanks of 50 m<sup>3</sup> above ground (subsequently demolished) and 1 tank of 100 m<sup>3</sup> horizontal above ground) when it has reached the maximum storage capacity.

Over time, phthalates, n-paraffins, dichloropropane and various types of esters have been added to the products mentioned. In the mid-1990s, however, chlorinated products were eliminated, with the exception of dichloropropane, which was eliminated at a later time.

It should be noted that in the mid-1990s some above ground tanks located along the border of the site with the Guisa stream were removed and in 1998 the underground tanks arranged along via San Gottardo, to the left of the entrance to the industrial area, were removed.





## 2.2 Geological setting

The area under study is located in the central sector of the Milanese mid-plain and is characterized by a sub-flat morphology, with topographic altitudes degrading towards the South, linked to fluvio-glacial and fluvial deposition of the Quaternary age. The morphological structure of the territory consists of extensive fluvio-glacial plains. To the south of the industrial site, the Guisa stream flows eastwards. The site consists of Postglacial Unity (Upper Pleistocene - Holocene), consisting of fluvial deposits with no alteration profile and poorly developed soil, less than one meter thick. From a lithological point of view, the deposits are generally made up of slightly silty sands, with interspersed gravels with a clastic support or a sandy matrix, generally loose.

In the area under examination, the hydrogeological units follow one another, from the most superficial to the deepest, according to the following scheme:

**Aquifer Group A:** consisting of deposits in high-energy braided fluvial facies. Lithologically it is mainly composed of coarse gravelly-sandy sediments with a medium-coarse sandy matrix with subordinate sandy intervals from medium to very coarse, with high porosity and permeability; locally there are decimetric levels of clay and silty clays and horizons consisting of cemented and conglomerate gravels. The thickness varies from a minimum of 26-30 m up to a maximum of 40-45 m and its lower limit is placed in correspondence with the first truly continuous clayey levels;

**Aquifer Group B:** consisting of deposits in braided fluvial facies. Lithologically it is mainly composed of coarse sediments represented by medium-coarse sands, pebbly sands and gravels with a sandy matrix with high porosity and permeability; downwards the granulometry of the sediments decreases and the cemented horizons (sandstones and conglomerates) and the levels of fine clayey-silty sediments become more frequent. The overall thickness is around 45 m on average with minimum values around 35 m and maximum values of 55 m.

**Aquifer Group C:** consisting of deposits in continental/delta transitional facies. Lithologically it consists of fine to medium sands and silty clays with peaty horizons interspersed with gravel-sandy levels with greater permeability. The overall thickness is unknown as the lower limit was not reached by the drilling of the deepest wells in the area. In the permeable levels there are intermediate and deep aquifers, of the confined type, whose vulnerability is mitigated by the presence of continuous clayey layers on the roof, but connections and feeding by the highly vulnerable upper free aquifer cannot be excluded.

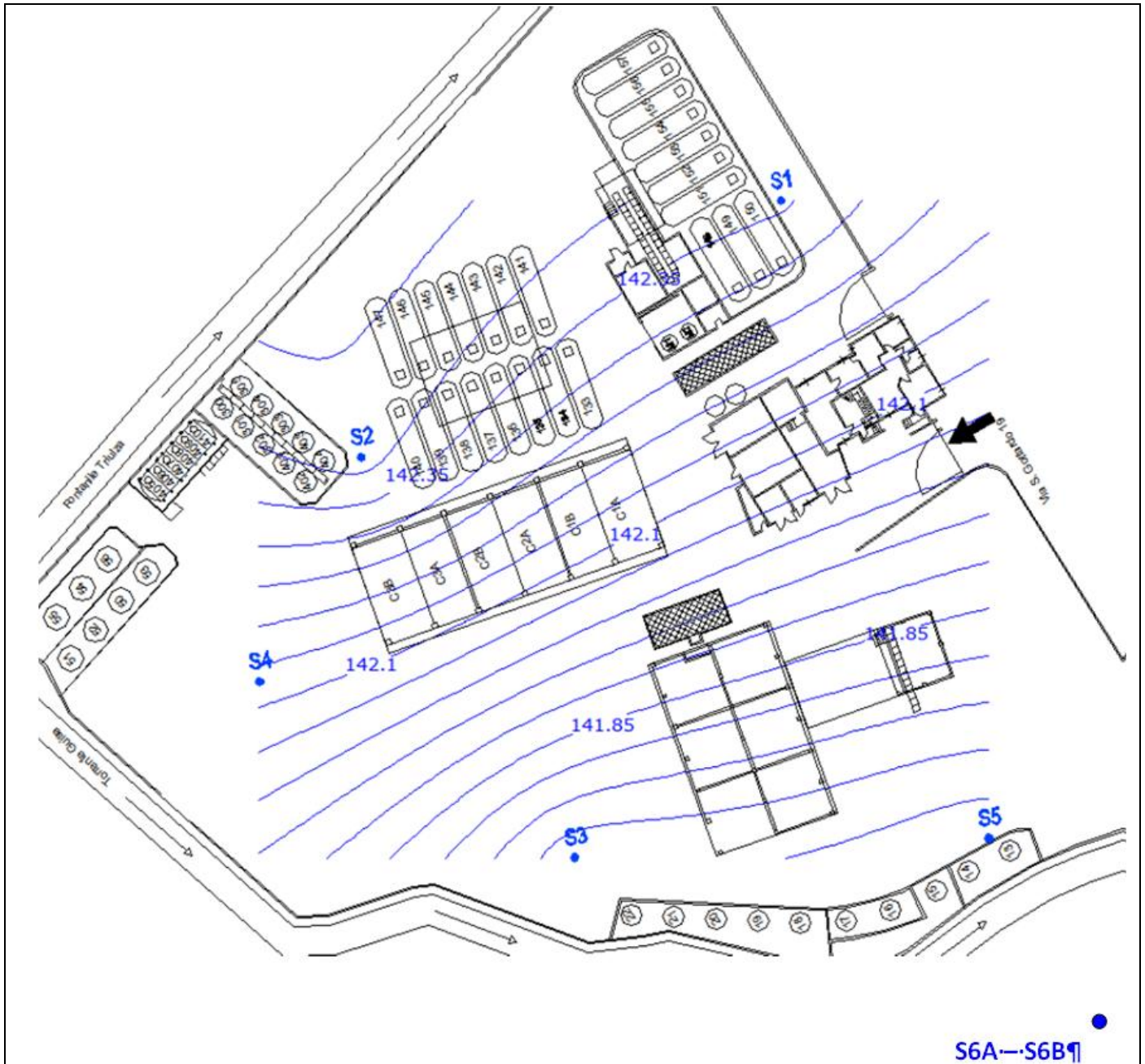

The aquifer groups A and B described above are the seat of the main free-type or locally semi-confined aquifer, characterized by subsidence around 20-30 m from the ground level, traditionally captured by the collection wells for drinking water purposes of old construction and from private wells (information taken from the document "Componente geologica, idrogeologica e sismica del Piano di Governo del Territorio" of the Municipality of Bollate, drawn up in 2010 by the "Studio Idrogeotecnico").

Specifically, in the area in question, it is possible to identify 2 distinct layers, separated from each other by a clay lens placed at a depth of 20 m; the static level of the surface





aquifer is around 8 m deep.

The image above shows the isopiezometric map drawn up in 2014 (the static levels were measured on 28/02/2014) for the additions to the site characterization plan; we deduce that the direction of the water table is NNE-SSW, with a gradient of about 1.6 ‰. The figure shows the 7 piezometers that make up the monitoring network and which were grounded in 1994.

The characteristics of the monitoring points are summarized below:

ID	Diameter - inches	Depth - m	volumetric flow (19/03/2014) - l/s
S1	4"	20	
S2	4"	15	0.5
S3	4"	20	0.2
S4	4"	18.5	
S5	4"	18	0.4
S6A	2"	20	
S6B	2"	38	

The S2, S3 and S5 piezometers are equipped with submersible pumps for the continuous pumping of water; these piezometers are part of the Pump and Treat (P&T) system which has been active since 21/09/1994. The plant consists of:

- a 30 m<sup>3</sup> tank for the collection and homogenization of the water extracted from the reclamation wells;
- a stripping tower for water purification;
- two activated carbon filters, with 80 kg carbon load, positioned in series, for the treatment of gases coming from the stripping tower;
- two activated carbon filters (4,000 kg + 1,000 kg approx.) for the treatment of wastewater leaving the stripping tower;
- a sand filter (approx. 1,000 l) to protect the activated carbon filter for water treatment.

The plant is also designed for the collection and purification of rainwater.

The treated water is discharged into the Guisa stream, which flows immediately downstream of the area.



## 2.3 Contaminants of concern

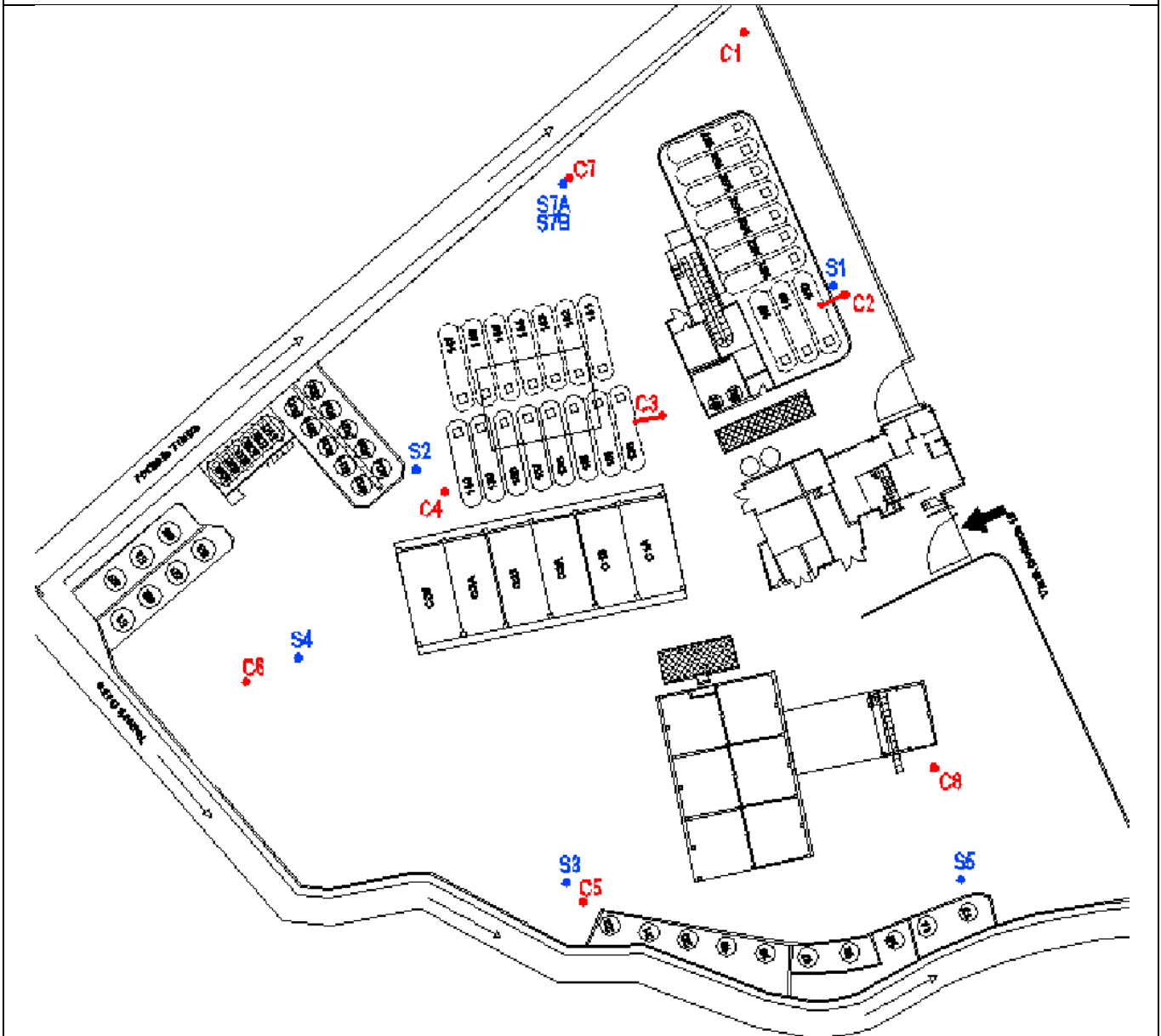

The site is characterized by contamination by chlorinated solvents, affecting both the land and the groundwater. The following figure shows the location of the surveys carried out (in red) for the characterization of the land and the location of the piezometers making up the groundwater monitoring network underlying the site (in blue). During the characterization activities, two additional piezometers, 2" each, respectively about 20 m deep (identification code S7A) and 40 m (identification code S7B) were installed with the aim of creating a monitoring point of the surface water



table ( S7A, to be compared with S6A) and a monitoring point of the deeper aquifer (S7B, to be compared with S6B). Each bore reached a depth of about 6 m from ground level and for each of them 3 soil samples were taken, one of superficial soil (between 0 and 1 m from b.c.), one intermediate and one in the last meter of the survey.

The analysis on the soil samples taken showed a contamination in correspondence of the C8 survey, both for the superficial and deep soil:

- surface soil (sample taken between 0.2 and 1 m from bw): Hydrocarbons C <12, Benzene and Tetrachlorethylene
- deep soil (sample taken between 2.3 and 2.7 m from b.c.): Trichloromethane and Trichlorethylene.

The maximum concentrations measured (taken from the Operational Remediation Plan, presented in December 2015) are shown in the following table.

<b>Contaminants</b>	<b>Maximum concentrations (mg/kg)</b>
Hydrocarbons C <12	2,120
Benzene	4.11
Tetrachlorethylene	50.7
Trichloromethane	10,536
Trichlorethylene	26,076

It has been estimated that the contamination affects an area of about 200 m<sup>2</sup>, located at a depth of 5 m, for a volume of about 1000 m<sup>3</sup>.

As regards groundwater, both the most superficial and the deepest aquifers present contamination by chlorinated solvents, but with significant differences in the concentrations of PCE (main contaminant) which are lower in the deeper aquifer where the concentration could also be linked, in part, to an upgradient contribution.

## 2.4 Regulatory framework

The reference limits considered are those contained in Legislative Decree 152/06, Tab. 1, Col. B (intended industrial use).



### 3. Pilot-scale application in field

#### 3.1 Extraction system

In the area reclamation project and related additions, the construction of an SVE (Soil Vapor Extraction) treatment plant was proposed, in the area around survey C8, characterized by the presence of soils contaminated mainly by chlorinated solvents. In the Reclamation Project it was proposed to combine the SVE also with an AR (Air Sparging) treatment for groundwater. It should be emphasized that on the site, as reported above, an operational safety system is already in operation consisting of 3 points of extraction of the groundwater, which are then sent to a treatment plant. This system will remain in operation also during the SVE/AS treatment.

Between 9 and 10 November 2016, the drillings were carried out for the preparation of the test field for the pilot test, which was carried out between 14 and 16 November. During the execution of the test the first SVE point made (later called SVEold) showed problems and, consequently, on 2/12/2016 a second SVE point was made to replace it. On 11/01/2017 the pilot test on the new point was repeated.

The technical-constructive characteristics of the survey points making up the test field are summarized in the following table:

Point	well	Diameter	Depth (m)	Screen (m)
SVE and SVE old	40X40	3"	4	1-4
SGS1	30X30	6 mm (rilsan)	1.5	1.2-1.5
SGS2	30X30	6 mm (rilsan)	1.5	1.2-1.5
SGS3	30X30	6 mm (rilsan)	1.5	1.2-1.5

The SVE point represents the aspiration point for the Soil Vapor Extraction (SVE) test and the SGS points were used as soil gas monitoring during the SVE tests.

The following figure shows the location of the survey points of the test field. In the image, the AS point is also indicated, which represents the air blowing point for the Air Sparging test (AS) and the MAS points, used as groundwater monitoring during the AS tests.

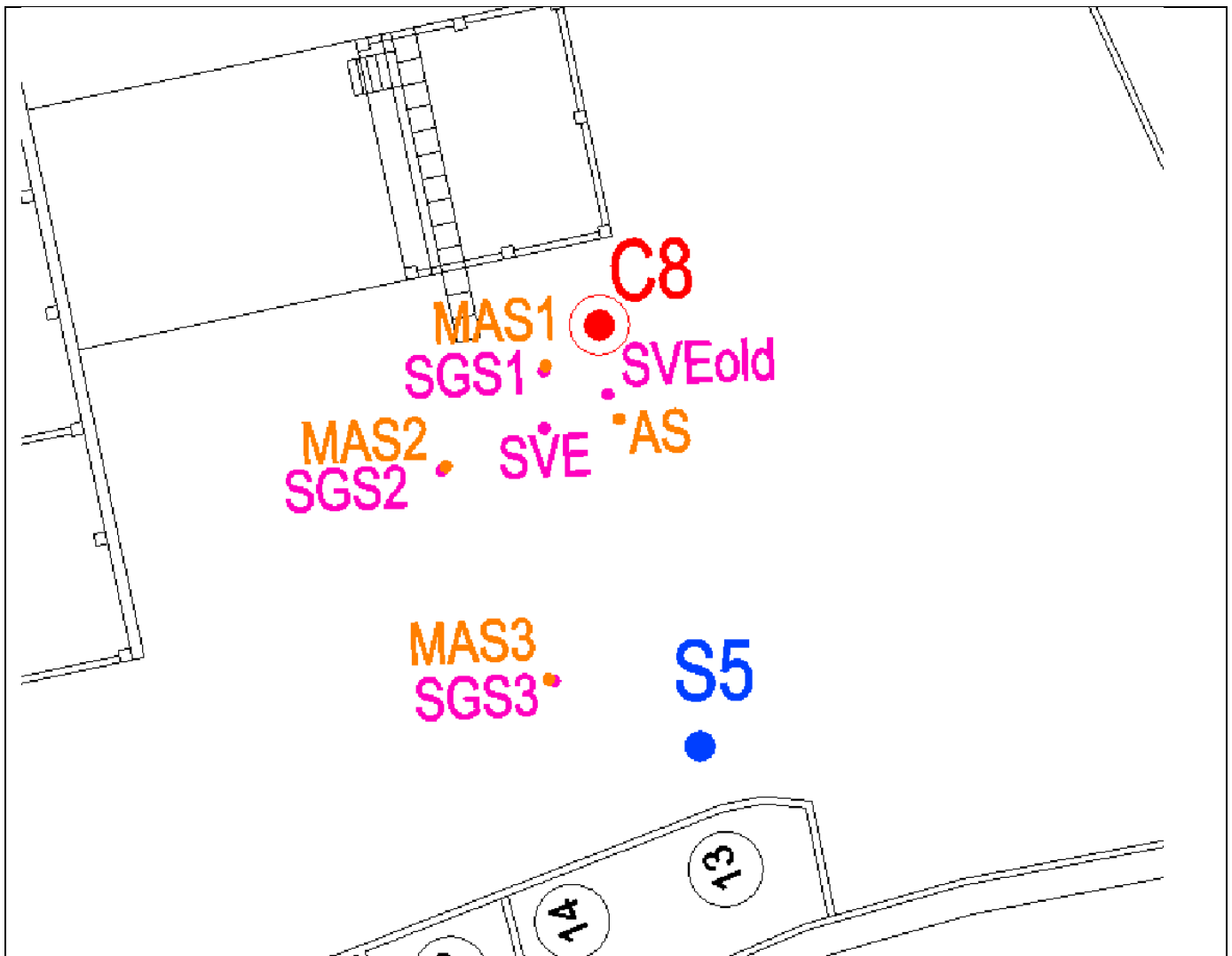

The following table shows the stratigraphy of the SVE point.

Depth (cm from ground level)	Description
0-30	Concrete slab
30-180	Filling consisting of slightly silty sands and gravels with some brick, brown color
180-300	Coarse sands and gravel with pebbles, gray/black color
300-400	Coarse sands and gravels, ocher color

The pilot test on the new SVE point was carried out on 11/01/2017.

The pilot tests were carried out by installing, at the SVE point (see image below), an aspiration system equipped with an activated carbon filter consisting of a rotary blower, regulation valves and vacuum-tight pipes.



The pilot test was performed by sucking air from the SVE point and monitoring, with field instruments, the following parameters:

- VOC (volatile organic compounds) of interstitial gases with the use of a Portable Photoionizer (PID);
- concentrations of oxygen, carbon dioxide, Lel (Lower Explosive Limit) of interstitial gases with a portable IR instrument;
- depressions induced by the rotary blower with a digital pressure gauge (thermo anemometer).

The parameters were measured at the monitoring points arranged around the suction point at distances varying between about 2 m and 8 m from the central point; the following table shows the name of the monitored points and the distance from the SVE point:



Monitoring point	Distance from SVE (m)
SVEold	2.4
SGS1	1.9
SGS2	3.7
SGS3	8.4

The SGS points intercept the horizon between 1.2 and 1.5 m from ground level.

The SVEold point has filters between 1 and 4 m.

First of all, a rapid flow step test was performed, increasing the pump flow in order to identify the flow rate to be used in the constant flow test. The constant flow test was then carried out and lasted for 5 hours, in order to verify the trend of the parameters in the subsoil, following the activation of an SVE system. The rotary pump was set at an average flow rate of 47 mc/h.

The parameters measured at the extraction point and at the monitoring points are summarized in the following tables.

#### SVE

Tempo minuti	Pid ppm	Lel %	O2 %	CO2 %	Depress mbar	V m/s	T °C	Q mc/h
<b>0</b>	480.1	18	21.3	1.22	-286.0	7.74	1.4	47
<b>10</b>	2147.0	16	21.5	3.45	-258.0	6.57	0.8	47
<b>30</b>	2371.0	13	20.9	3.16	-249.0	6.23	4	43
<b>60</b>	4106.0	13	20.9	2.7	-236.0	6.77	4.1	50
<b>90</b>	4469.0	10	20.9	2.26	-232.0	7.46	4.6	53
<b>120</b>	5000.0	10	20.9	2.08	-229.0	8.27	5.2	57
<b>180</b>	5000.0	9	20.9	1.83	-225.0	9.03	5.9	64
<b>240</b>	5000.0	9	20.9	1.62	-222.0	9.53	6.9	67
<b>300</b>	5000.0	8	20.9	1.44	-220.0	9.6	7	72

#### SVE old

Tempo minuti	Pid ppm	Lel %	O2 %	CO2 %	Depress mbar
<b>0</b>	1824.0	47	21.3	4.99	0.0
<b>10</b>	1867.0	40	21.5	4.99	0.0
<b>30</b>	2042.0	27	20.9	4.39	0.0
<b>60</b>	2015.0	27	20.9	3.81	-0.9
<b>90</b>	1140.0	2	20.9	0.04	-7.5
<b>120</b>	285.9	2	20.9	0.07	-15.0
<b>180</b>	211.6	0	20.9	0.04	-20.0
<b>240</b>	112.7	0	20.9	0.04	-22.0
<b>300</b>	93.6	0	20.9	0.07	-24.0

#### SGS1

Tempo minuti	Pid ppm	Lel %	O2 %	CO2 %	Depress mbar
<b>0</b>	544.3	0	21.3	4.99	-5.8
<b>10</b>	261.1	5	21.5	4.99	-6.5
<b>30</b>	61.3	2	20.9	0.07	-7.0
<b>60</b>	266.0	0	20.9	0.07	-7.5
<b>90</b>	125.5	4	20.9	2.05	-8.5
<b>120</b>	93.2	0	20.9	1.62	-9.5
<b>180</b>	88.5	0	20.9	1.65	-9.5
<b>240</b>	73.2	0	20.9	1.11	-10.0
<b>300</b>	73.8	0	20.9	1.25	-10.0





<b>SGS2</b>						<b>SGS3</b>					
<b>Tempo</b>	<b>Pid</b>	<b>Lel</b>	<b>O2</b>	<b>CO2</b>	<b>Depress</b>	<b>Tempo</b>	<b>Pid</b>	<b>Lel</b>	<b>O2</b>	<b>CO2</b>	<b>Depress</b>
minuti	ppm	%	%	%	mbar	minuti	ppm	%	%	%	mbar
<b>0</b>	1872.0	14	21.3	4.99	-6.6	<b>0</b>	4852.0	9	21.3	0	0.0
<b>10</b>	2492.0	20	21.5	11	-16.0	<b>10</b>	5000.0	5	21.5	0	0.0
<b>30</b>	2030.0	16	20.9	4.82	-22.0	<b>30</b>	3866.0	4	20.9	0	0.0
<b>60</b>	2550.0	14	20.9	4.53	-36.0	<b>60</b>	4670.0	5	20.9	0.04	0.0
<b>90</b>	2903.0	11	20.9	4.1	-38.0	<b>90</b>	5000.0	4	20.9	0	0.0
<b>120</b>		10	20.9	3.67	-39.0	<b>120</b>	5000.0	4	20.9	0	0.0
<b>180</b>					-41.0	<b>180</b>	5000.0	0	20.9	0	0.0
<b>240</b>					-43.0	<b>240</b>	5000.0	0	20.9	0	0.0
<b>300</b>					-45.0	<b>300</b>	5000.0	0	20.9	0	0.0

The missing data are due to the presence of condensation in the pipes that did not allow the use of the instrumentation.

Data analysis:

- the Pid highlights the increase in values at the SVE point and the simultaneous decrease in the monitoring points, in accordance with the recall of contaminants at the suction point;
- the Lel decreases in all points;
- oxygen stabilizes at 20.9%;
- carbon dioxide shows a tendency to decrease over time;
- the depressions show a greater response to pumping in SGS2 than in SGS1, closer to the SVE point, probably due to the conformation of the subsoil in the area in question; in point SGS3 there are no effects induced by pumping.

During the test, due to local conditions, the extracted flow rate varied from 47 mc/h (set at the beginning) to approximately 70 mc/h. With this capacity, considering what is highlighted by the data, the effects of the vacuum induced by pumping can be observed in the control points SVEold, SGS1 and SGS2 while the point SGS3 does not show variations. The range of influence, therefore, is between 4 and 8 m.

### 3.3 Radius of influence

During the pilot test, performed by sucking air from the central point called SVE, the induced depressions in the monitoring points, called SVEold, SGS1, SGS2 and SGS3, were measured and arranged as illustrated in par. 3.1. The effects of the vacuum induced by pumping are observable in the control points SVEold, SGS1 and SGS2 while the point SGS3 shows no variation. The range of influence, therefore, is between 4 and 8 m.





### 3.4 Off gas Treatment

In the SVE point, an extraction system with an activated carbon filter was installed.

### 3.5 Control parameters

During the pilot test, as reported above, the following parameters were monitored with field instruments:

- VOC (volatile organic compounds) of interstitial gases with the use of a Portable Photo ionizer (PID);
- concentrations of oxygen, carbon dioxide, LEL (Lower Explosive Limit) of interstitial gases with a portable IR instrument;
- depressions induced by the rotary blower with a digital pressure gauge (thermo anemometer).

The recorded data made it possible to identify the air permeability of the soil and the range of influence of the suction system sized for a suction point.

## 4. Full-scale application

### 4.1 Extraction system

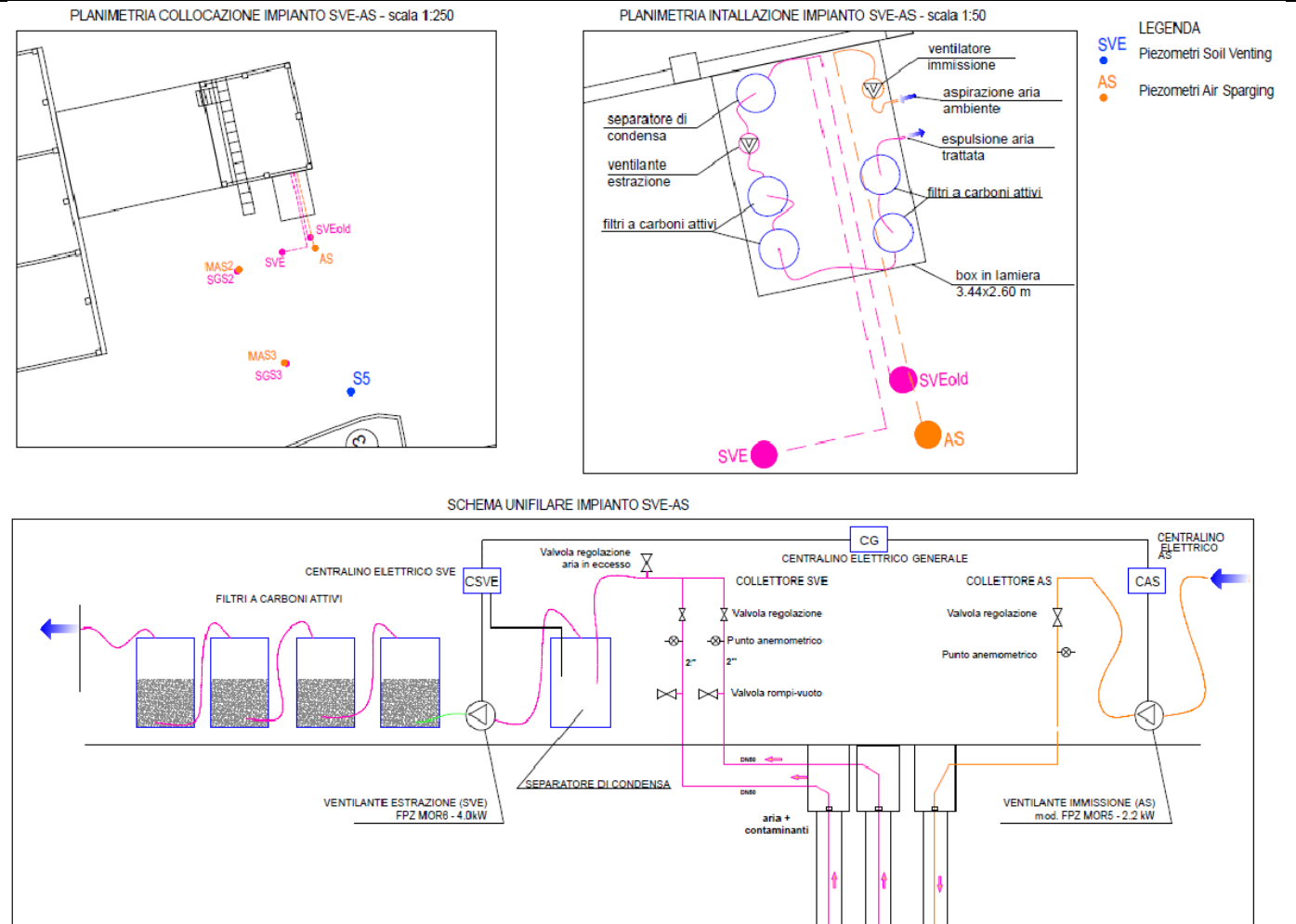

The plant and its monitoring were started on 14/03/2019.

On the basis of the pilot test performed, it was assumed, as a precaution, a range of action equal to 4 m for the SVE point; consequently it was decided to equip two points for the extraction of vapours, namely the point called SVE and the point called SVEold. During the work, specific calibration tests will be conducted in order to set the optimal configuration for the system.

The SVE and SVEold extraction wells made have the following characteristics:

- drilling up to 4 m deep;
- installation of piezometer (diameter 3"), depth 4 m, fenestrated between -1 and -4 m from the ground floor;
- cementation from p.c. at -1 m;



- installation of calibrated siliceous gravel from –1 m to –4 m from p.c.

The wellhead of the vertical intake is connected to the manifold, mounted at the plant box, which is connected to the separator and subsequently to the aspirator and filter (see image below, which also indicates the Air Sparging system).

### 4.3 Radius of influence

Based on the monitoring of the lowering measured during the pilot test at the control points (SVEold, SGS1, SGS2 and SGS3) the influence range is between 4 and 8 m; consequently, as a precaution, a radius of influence equal to 4 m was considered.

### 4.4 Off gas Treatment

Activated carbon filter

Downstream of the suction system, two containers of activated carbon weighing about 50 kg each were placed in series.

### 4.5 Control parameters

In order to monitor the effectiveness of the SVE/AS system, periodic monitoring of the system and sampling of interstitial gases has been prepared.

With regard to the monitoring of the plant, a fortnightly frequency of checks has been established during the first 2 months of activity, monthly up to 6 months, and quarterly up to 12 months of plant activity. During the checks, measurements of the main flow parameters of the system are carried out with field instruments capable of determining air flow (anemometer), temperature, VOC concentration (PID), differential pressure between the fixed probes in the ground and the atmosphere (Magnehelic).

Samplings of soil gases by means of activated carbon vials were also provided. On 14/03/2019 "zero" sampling took place, coinciding with the start-up of the plant. A further 4 samplings were scheduled during the 12 months of reclamation, foreseen by the project.



## 5. Enhancements to SVE

### 5.1 Pneumatic and/or hydraulic fracturing

As mentioned above, an AS (Air Sparging) plant was associated with the SVE for the treatment of groundwater underlying the site. The plant consists of a piezometer, for the injection of atmospheric air into the groundwater, with a depth of 9 m. Three piezometers (called MAS1, MAS2 and MAS3) were also created at a distance of 3, 6 and 9 m from the first one for the introduction of air, as monitoring points. The latter were carried out at the points provided for the monitoring of soil gases (SGS), within the same drilling, in such a way as to optimize economies.

## 6. Post treatment and/or Long Term Monitoring

### 6.1 Post treatment and/or Long Term Monitoring

The monitoring plan provided for a sampling of soil gases upon activation of the plant and 4 samplings during the remediation.  
For the sampling of soil gases, activated carbon vials are used for the determination of C <12 hydrocarbons, with relative speciation, Benzene, Tetrachlorethylene, Trichloromethane and Trichloroethylene.



## 7. Additional information

### 7.2 Additional information

Initially, it was planned to carry out a test through soil sampling, after 12 months of treatment, to verify the state of contamination and evaluate any further actions. To date, the treatment of the land is still ongoing, since, following a failure of the plant which occurred in 2020, it was decided to extend the treatment for a further year. At the time of testing, soil samples must be taken from two cores carried out near point C8, at depths of 0-1 m and 2-3 m. The analytical set must include:  
Sample 0-1 m: C <12 hydrocarbons, with relative speciation, Benzene, Tetrachlorethylene  
Sample 2-3 m: Trichloromethane, Trichloroethylene.

## Glossary of Terms

<b>Term (alphabetical order)</b>	<b>Definition</b>
SIN	Contaminated site of national priority list
PA	public administration

## 1. Contact details - CASE STUDY: SVE n.18

<b>1.1 Name and Surname</b>	Massimiliano Confalonieri – Valter Meda
<b>1.2 Country/Jurisdiction</b>	Italy
<b>1.3 Organisation</b>	Agenzia Regionale per la Protezione dell’Ambiente (ARPA) della Lombardia
<b>1.4 Position</b>	Dirigente RUO BARAE – Tecnico UO BAE MI-MB
<b>1.5 Duties</b>	
<b>1.6 Email address</b>	<a href="mailto:m.confalonieri@arpalombardia.it">m.confalonieri@arpalombardia.it</a> <a href="mailto:v.meda@arpalombardia.it">v.meda@arpalombardia.it</a>
<b>1.7 Phone number</b>	+39 335 531 8045





## 2. Site background

### 2.1 History of the site

The area in question is located in the territory of the Municipality of Villasanta (Monza and Brianza province), north of the Milan urban area and is geographically located in the high Lombard plain, immediately south of the pre-Alpine moraine hills.

The site was affected by the presence of an industrial plant built in 1971 and dedicated to the production of air conditioning equipment. Industrial production has ceased but the site retains its industrial use and the area is occupied by commercial and/or logistics activities.

The main production cycles concerned:

- mechanical processing of metals;
- oven painting with organic solvent paints;
- electrophoresis painting.

Both painting processes, discontinued in 1994, were supported by a waste water treatment plant. The main structures present were made up of:

- a purification plant (decommissioned in 1994) with two masonry tanks, a settler and a sludge drying tank;
- a thermal power plant, currently fuelled by methane;
- 5 underground tanks located about 10 m from the south west corner of the thermal power plant, n. 4 of which containing fuel oil and n. 1 containing diathermic oil. All fuel oil tanks would have been removed in 1991 during the construction of the underpass. The diathermic oil tank was removed and replaced with a new double-walled tank positioned along the east side of the thermal power plant. This latter tank also seems to have been removed in 1992 with the construction of the thermal power plant;
- 2 electrical transformer cabins, one located in the thermal power plant and one inside body C. The one in the thermal power plant has a single transformer and is currently not in use, with a concrete containment tank in good condition. The one inside body C is in use. Transformers with PCB-containing oils were reclaimed and replaced in 1989

The site was affected by a remediation procedure according to the regional regulations in force at the time that began before the entry into force of the Ministerial Decree of 25 October 1999, n. 471. Later, the process has been developed according to the ordinary operational and administrative procedures laid down by Legislative Decree 3 April 2006, n. 152.

Since the area is not included in the case of SIN or SIR in implementation of the regional

delegations, the competent authority in charge of the administrative acts is the municipal administration.

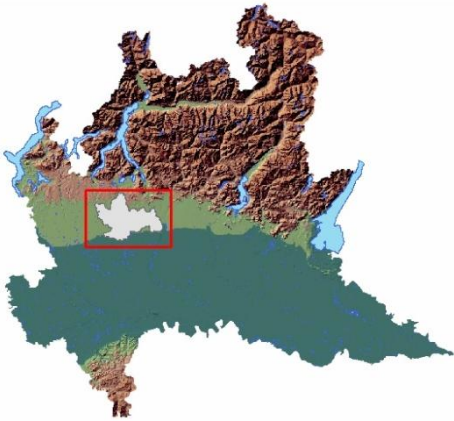

Lombardy – Monza Brianza Province

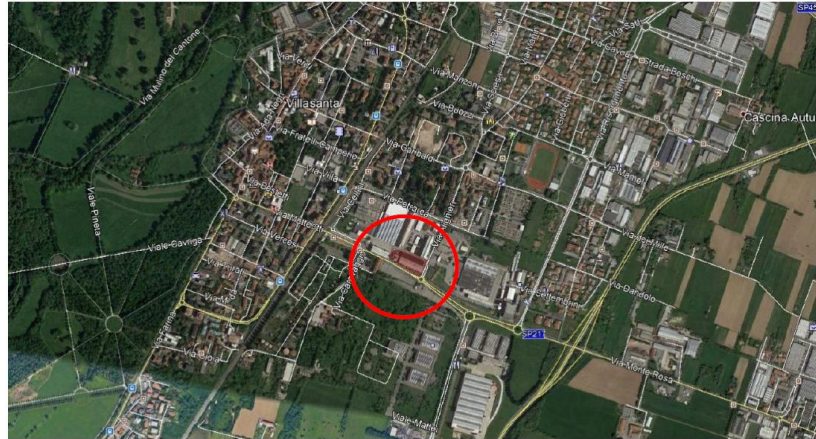

Villasanta – site location

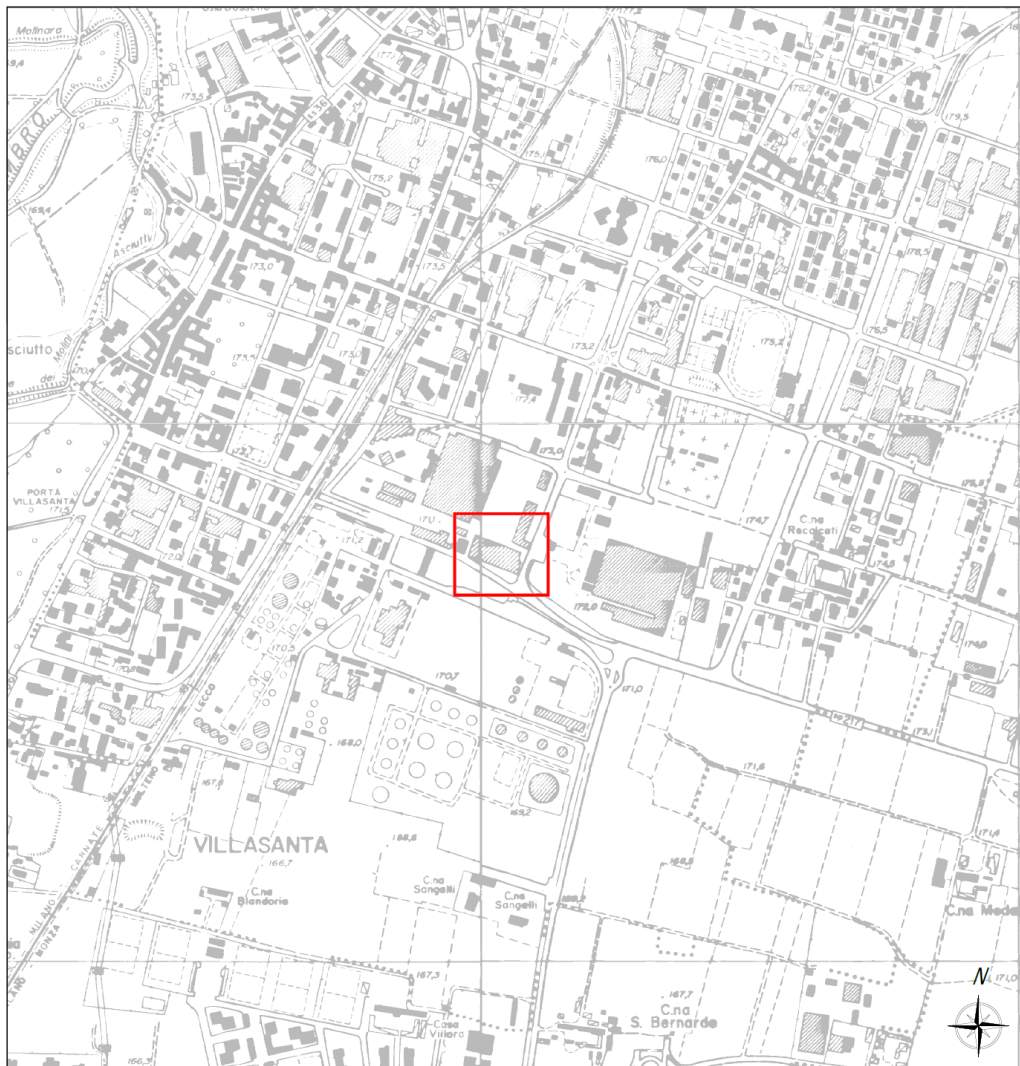

Base cartografica: Stralcio C.T.R. Regione Lombardia fogli B5c4, B5c5, B5d4, B5d5 scala 1:10.000 (mod)

Villasanta – site location (Technical Regional map 1:10:000)

## 2.2 Geological setting

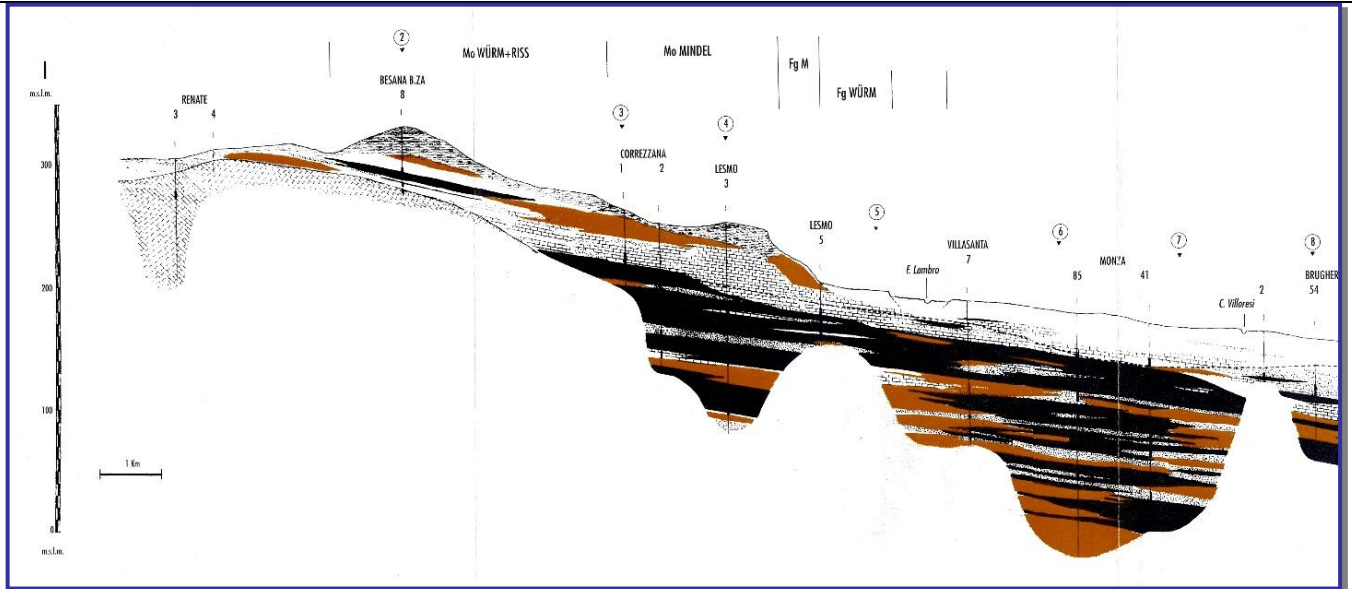

NS hydrogeological section of the central area and the Lambro basin (from: Provincia di Milano, 1995)

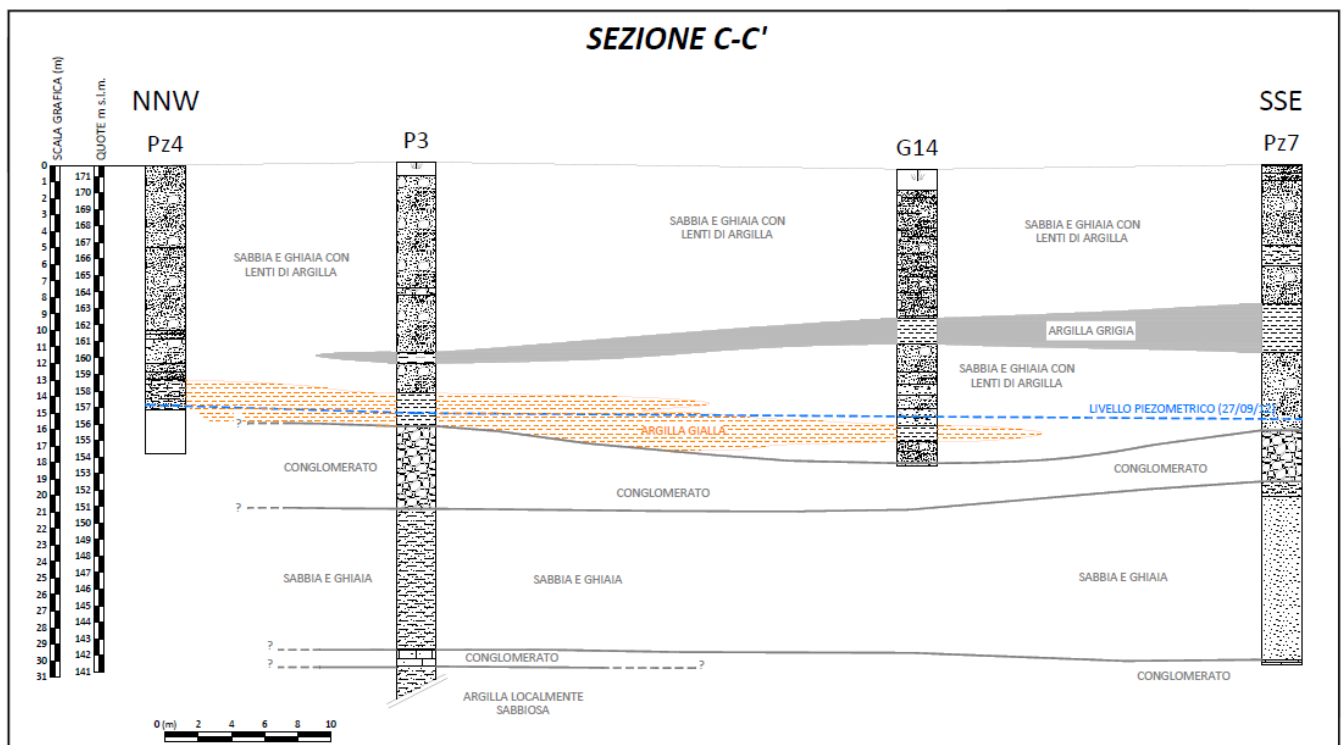

Stratigraphic detail of the intervention area

The western border of the municipal area coincides with the path of the Lambro river.

Geologically, the subsoil of Villasanta can be included within the Fundamental Level of the Plain (LFP), traditionally characterized by deposits of late Pleistocene fluvial-glacial origin, consisting of sands and gravels with pebbles that form the Lombard plain. Near the banks of the Lambro, more recent sediments develop which can be associated with the depositional activity of the watercourse itself. From a petrographic and lithological point of view, the origin of the Lambro deposits is strictly attributable to the portion of the pre-Alpine chain which, within the reference hydrographic basin, crops out in correspondence with the Larian triangle between Como and Lecco. This can be distinguished due to the outcrop of Mesozoic geological units of a predominantly calcareous nature.

The presence of the Lambro river also affects the alluvial sediments, whose deposition over time has given rise to real paleo-riverbeds with high transmissivity values.

In general, in the area under examination, the subsoil is characterized in the superficial portion by the presence of mainly gravelly-sandy lithology horizons, with high permeability and thickness values. Proceeding in depth, the progressive lithological variations due to the prevalence of fine-textured lithologies (clays, silts and fine sands) determine a reduction in permeability. Under these conditions, the aquifer horizons are limited to isolated lenses of relatively permeable material and of modest thickness. The hydrogeological structure traditionally described by authors on the basis of the permeability characteristics has led to the identification of three main hydrostratigraphic units having the following characteristics:

- first aquifer: consisting of prevailing gravels and sands, with subordinate fractions of silts and gravelly-sandy horizons locally cemented. These sediments can be traced back to the recent and ancient alluvial and fluvio-glacial deposits from Würm (upper Pleistocene) which constitute the Fundamental Level of the Plain (LFP). This unit contains the upper part of the traditional aquifer, characterized by relatively high hydraulic conductivity values between  $10^{-3}$  and  $10^{-4}$  m/s. The characteristics of the aquifer are those typical of a free, unconfined water table;
- second aquifer: consisting of gravels and silty sands and conglomeratic horizons. These lithotypes are traditionally attributed to the ancient fluvio-glacial deposits of Mindel and Riss (lower Pleistocene) which on the surface give rise to the characteristic “ferretto” terraces of the foothills and hills of Brianza. The permeability of the aquifer which has hydraulic conductivity values of an order of magnitude lower than those of the first aquifer and equal to about  $10^{-4}$ - $10^{-5}$  m/s. This aquifer can contain a free aquifer or, in the presence of horizons that are not very permeable to the roof, locally semi-confined, generally in connection with the one above. Where the piezometric load differences between the two aquifers are more significant, water exchanges between the aquifers may occur due to the phenomenon of drainage;





- third aquifer: characterized by predominantly fine-textured soils, such as silts and clays with fine sand levels. These deposits are attributed in literature to the so-called Villafranchian clays. Due to the clear prevalence of fine-grained lithotypes, the hydraulic conductivity values in sandy lenses are approximately  $10^{-4}$ - $10^{-6}$  m/s. The sandy lenses themselves are home to confined and protected aquifers.
- In the area of Monza and Villasanta the hydrogeological characteristics of the subsoil are particularly different compared to the adjacent areas, in particular due to the presence of a high structure (Monza ridge) which causes the Villafranchian substrate to rise with a consequent reduction in the thickness of the aquifers. This hydrogeological situation makes it possible, in the sector east of the Lambro river, to interconnect the first and second aquifers with consequent possible mixing between contaminated aquifers and good quality aquifers.

The superficial aquifer (groundwater) is contained in the sediments that form the gravelly-sandy-silty unit and the conglomeratic unit (Ceppo auct.). As already mentioned, the two units are only locally separated by semi-permeable deposits which can give rise to differences in the piezometric level, although, in general, compared to the adjacent western area, the traditional aquifer is substantially undifferentiated. In the area under examination (Villasanta) the presence of a suspended aquifer supported by a discontinuous silty-clayey lens and contained in deposits with a prevalently gravelly-sandy texture was also ascertained.

## 2.3 Contaminants of concern

The site is characterized by the presence of contamination:

### Soil and subsoil

The characterization investigations on the entire site have shown overall compliance with the CSCs envisaged for the specific intended commercial and industrial use.

On the basis of historical investigations and analyses carried out by means of soil gas survey, the presence of tetrachlorethylene was ascertained in the entire horizon thickness unsaturated underlying the building in which the main painting cycles and degreasing of materials was carried out.

The figure below shows the values measured in the interstitial gases during the characterization phase and before the application of the SVE technology.

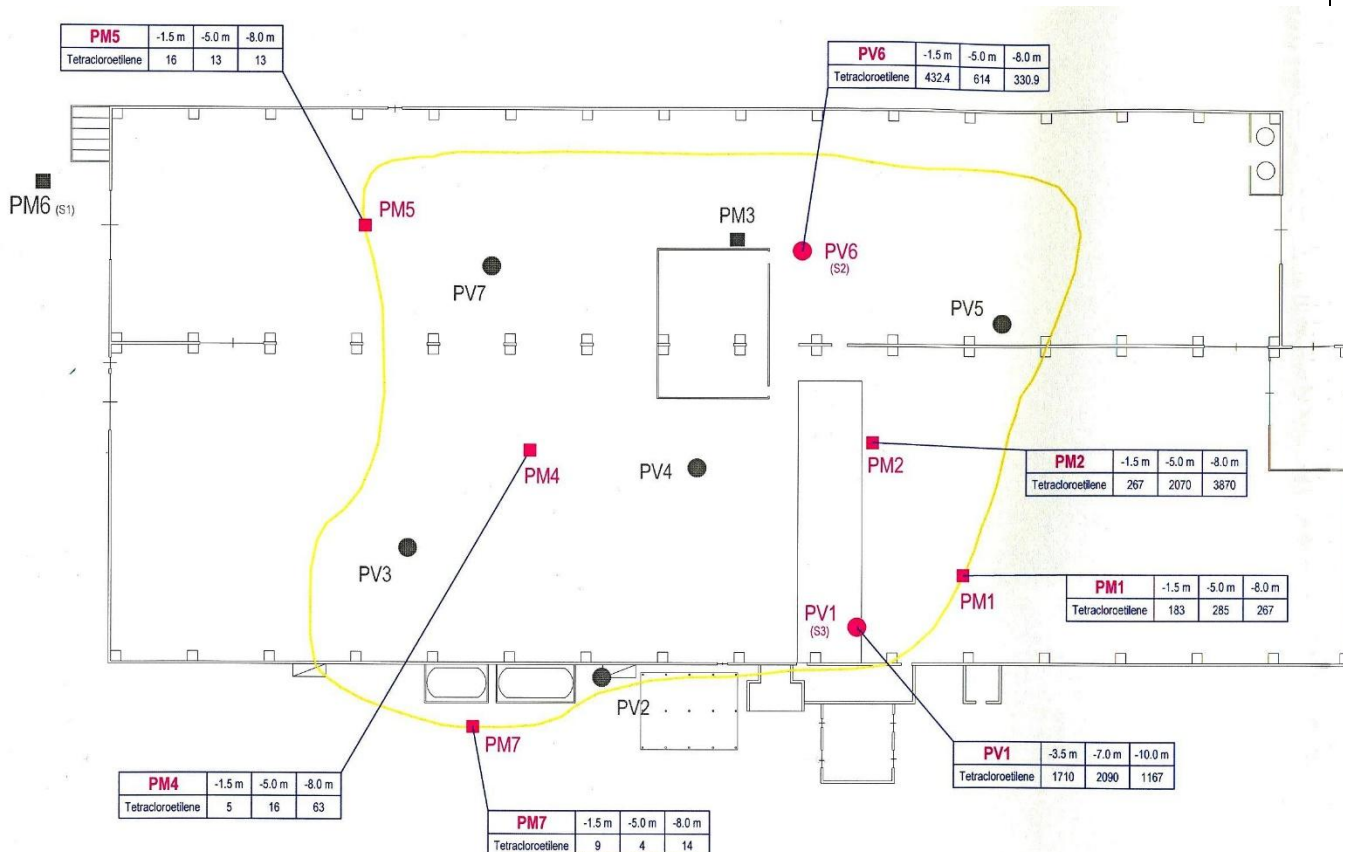

### Groundwater

Contamination of the groundwater in the area is essentially and almost exclusively due to tetrachlorethylene (PCE), with associated low concentrations of trichloroethylene (TCE) and chloroform (TCM). The presence of this substance in concentrations up to



400 times the CSC is well above the background value that is generally found in most of the area north of Monza and which roughly corresponds to the values found "at the entrance" to site, in the hydrogeologically upstream piezometer, between 6.5 and 48µg/l.

High concentrations were detected in 2002 throughout the south-eastern portion of the plant, in correspondence with some wells, with values up to 473 µg/l. The origin of the contamination has been traced back to the washing and degreasing of pieces using PCE, a solvent stored in underground tanks present in the building subject to the renovation.

CodiceSIF	denonint	data	PCE
0152390026	Well 3	11-mar-04	180
		14-set-04	198
		07-apr-05	61.14
		23-mar-06	28.7
		22-mag-07	286
		25-lug-08	340
0152390043	Well 5	11-mar-04	28
		14-set-04	168
		07-apr-05	27.6
		23-mar-06	22.2
		22-mag-07	22
		25-lug-08	7.5
0152390054	Pz 1 (upgradient)	11-mar-04	48
		14-set-04	39
		07-apr-05	21.7
		23-mar-06	8.6
		22-mag-07	6.5
		25-lug-08	6.7
0152390065	Pz 2 (downgradient)	11-mar-04	11
		14-set-04	19.37
		07-apr-05	3.99
		23-mar-06	5.8
		22-mag-07	4.2
		25-lug-08	4.2
0152390066	Pz 3 (upgradient)	11-mar-04	4.6
		14-set-04	3.2
		07-apr-05	3.04



0152390067	Well 6 (pumping well)	23-mar-06	4.69
		22-mag-07	7.1
		25-lug-08	0.7
		11-mar-04	200
		14-set-04	213
		07-apr-05	64.32
		20-mar-06	42.29
		22-mag-07	38.6
		25-lug-08	320

The map shows the points of the monitoring network in the configuration active in 2010

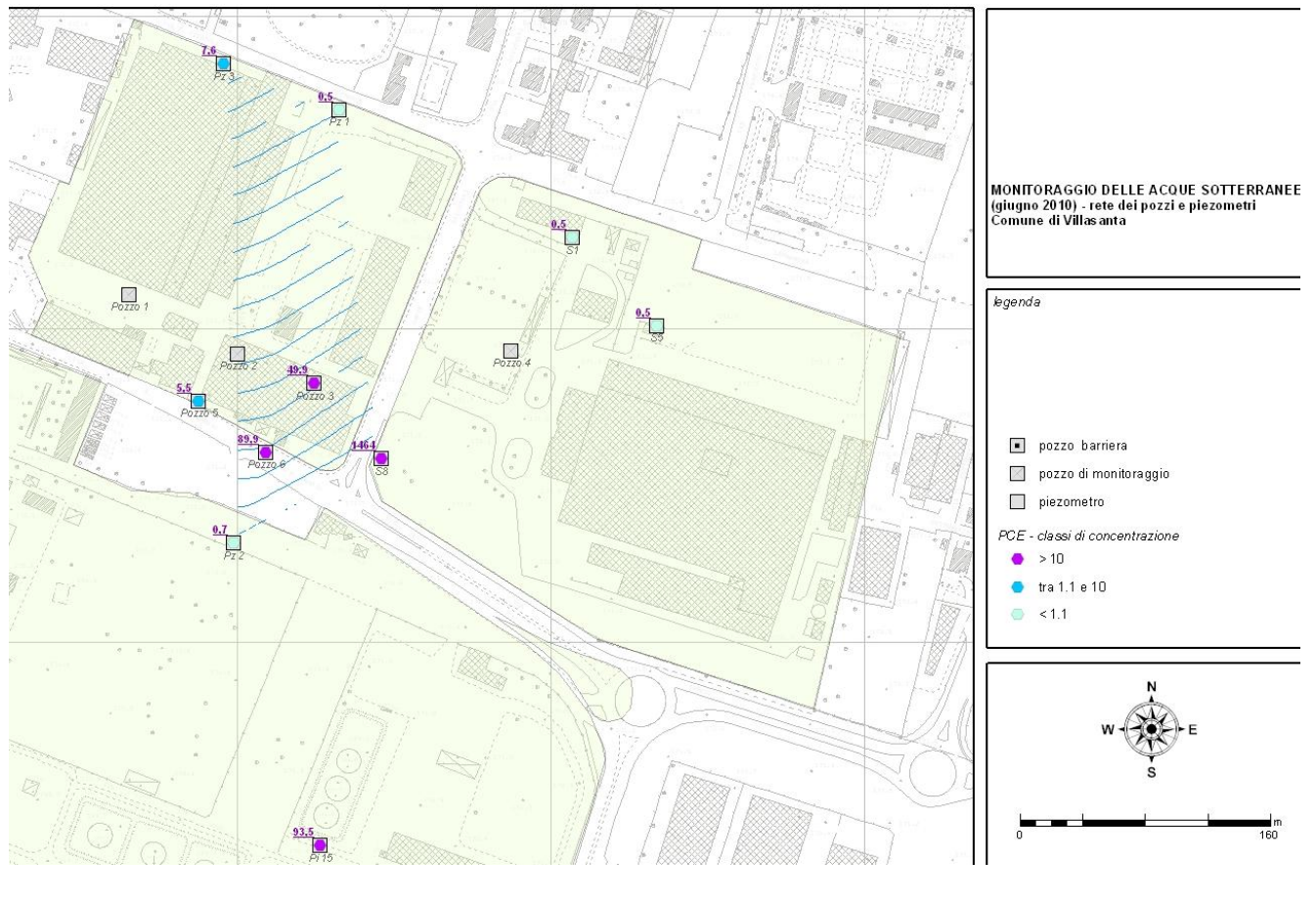



## 2.4 Regulatory framework

The remediation process of the area had been started before the national legislation on the remediation of contaminated sites came into force (Legislative Decree 22/97 and Ministerial Decree 417/99), applying the reference standards already existing in the Lombardy Region before 1997.

During the verification of the interstitial gases carried out at the building called "former Battery Department" or "former Building B", located in the south-east portion of the plant, the presence of PCE was detected in the interstitial gases and in excess concentrations to the regulatory limits even in groundwater.

In light of this, the company has sent its notice pursuant to dell' art. 242, paragraph 1 of Legislative Decree 152/06 to the competent local authorities in February 2011.

Following this communication, the Characterization Plan of the area on which the former Building B stands was drawn up and sent to the Authorities, subsequently approved in the Conference of Services in May 2011 by the competent Authority.

In July-August 2012 a new interstitial gas sampling campaign was carried out; with the results obtained, relative to the PCE concentrations, it was possible to redefine the spread of contamination in the subsoil, the starting point for the elaboration of the Risk Analysis.

The site-specific Health and Environmental Risk Analysis document was favourably assessed with prescriptions by the Authorities during the Service Conference in October 2012.

Therefore, in 2012 an additional document with acceptance of Conference of Services prescriptions that defines the CSR for soil gas and groundwater as remediation targets was prepared.

Following approval of the remediation objectives, equal to 71 mg/m<sup>3</sup> of PCE in soil gas for the unsaturated portion of land, a remediation project of the total subsoil was drawn, which also included the portion of the aquifer assessed in the Conference of Services in March 2013 with related observations and additions by the Authorities.



## 3. Pilot-scale application in field

### 3.1 Extraction system

The technology applied for the remediation of the area consisted of the combination of an extraction plant (SVE) for unsaturated soil, associated with an Air-Sparging (AS) plant for the remediation of groundwater (saturated).

In consideration of the geological-stratigraphic structure of the soil, characterized by the alternation of horizons with coarse and medium fine textures, the design of the SVE plant was carried out on the basis of data already available on site, having been active in a network of wells for interstitial gas measurement.

For the correct sizing of the AS system, a pilot module was instead prepared.

In relation to the local stratigraphic succession and in particular to the presence of clay lenses in the area to be reclaimed, the overall system of SVE and AS was created with the following characteristics:

- n. 18 suction wells of which:
  - n. 5 "shorts" (PV1, PM2, PV6, VW14 and VW15) → with filtering section between pc and the roof of the first clay lens, used for the remediation of unsaturated soil, possibly still polluted.
  - n. 7 "intermediate" wells (VW1 - VW7) → with filtering section between the first and second clay lens, necessary to concentrate the recall of polluting vapours in this area, where the effect of AS will be greater and where the vapours will concentrate;
  - n. 6 "long" wells (VW8 - VW13) → with filtering section between 6 and 14-15 m deep, or in any case one meter above the height of the phreatic surface, will instead have the function of area limiting the diffusion of the AS effect and treat the vapours deriving from the groundwater.
- n. 6 insufflations wells (AS1 - AS6) located inside the former Battery Department, in the area of maximum PCE concentration in interstitial gases. In the pilot scale application, the construction of a well for insufflations of groundwater (AS/G14) and n. 6 monitoring wells positioned around the AS;
- n. 2 SVE systems, consisting of a condensate separator, a side channel aspirator and an activated carbon filter, of which:
  - plant 1 to which the "short" wells are connected;
  - plant 2 to which the "intermediate" and "long" wells are connected;
- n. 1 AS system consisting of a blower in correspondence with each AS well, capable of blowing air at the established flow rates and pressures.
- n. 3 monitoring wells, necessary especially in the initial start-up phase, to check the

influence rays of the venting wells.

The system was initially launched in the pilot phase and after two months, once the functional and monitoring data of the system itself had been acquired, it came into operation at full capacity.

The data collected during the monitoring made it possible to regulate flows and depressions of the plants. The results obtained from monitoring with colorimetric vials, on the other hand, gave a more precise indication of the presence of PCE in interstitial gases. Over time, the outermost wells were closed, particularly in the westernmost area where the PCE values were zero, in order to concentrate the area of influence of the SVE in the most critical areas.

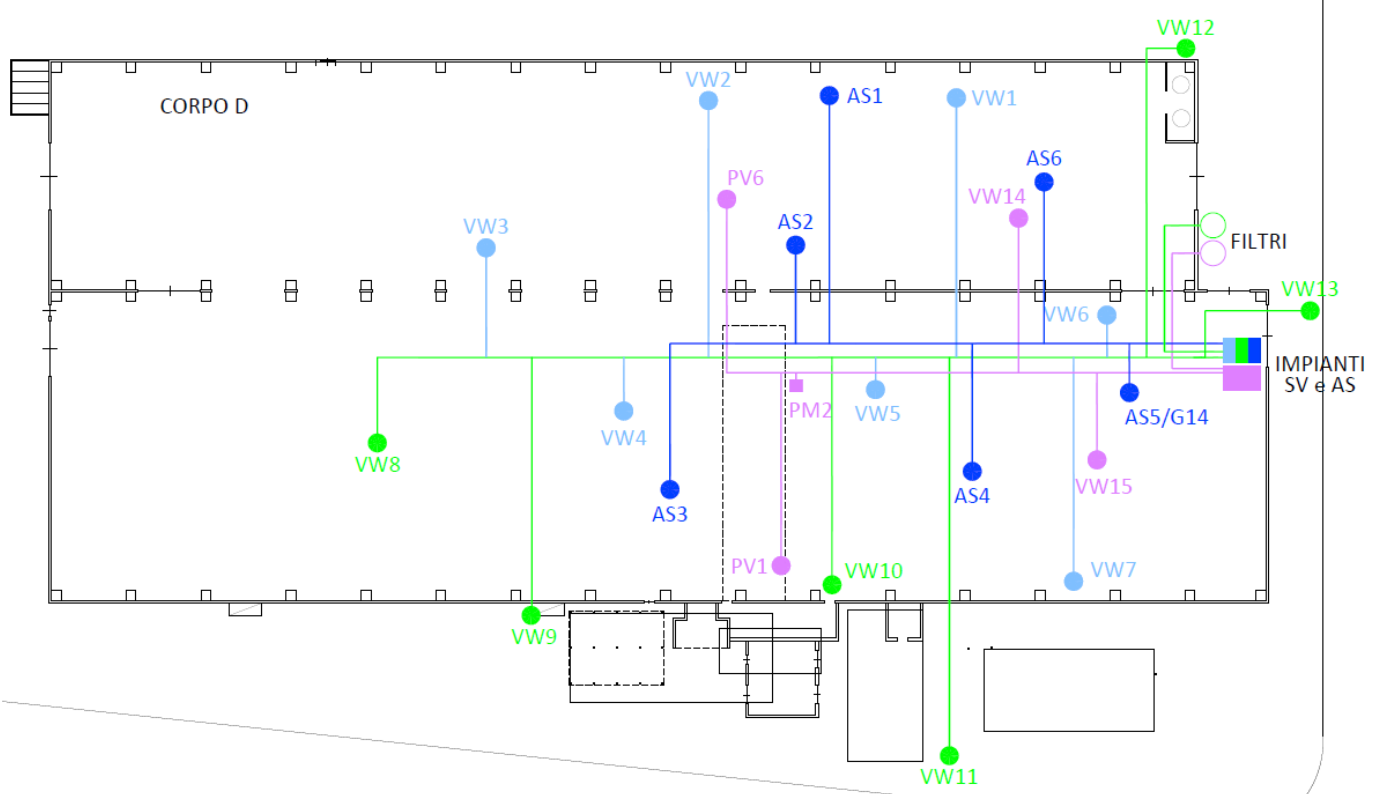

Position of the AS and SVE wells

## 3.2 Injection system

The AS plant was divided into n. 6 insufflations wells (AS1 - AS6) located in the area of maximum PCE concentration in interstitial gases.

In the pilot scale application, a well for insufflation of groundwater (AS/G14) and n. 6 monitoring wells were constructed positioned around the AS.

The carrier gas used was air, injected through diffusers to maximize the flow and increase the area exposed to the treatment. Thanks to the diffusion of high air flow, distribution was homogeneous in the contaminated area and the stripping effect of the volatile contaminants (PCE) from groundwater which are then extracted by SVE was amplified.

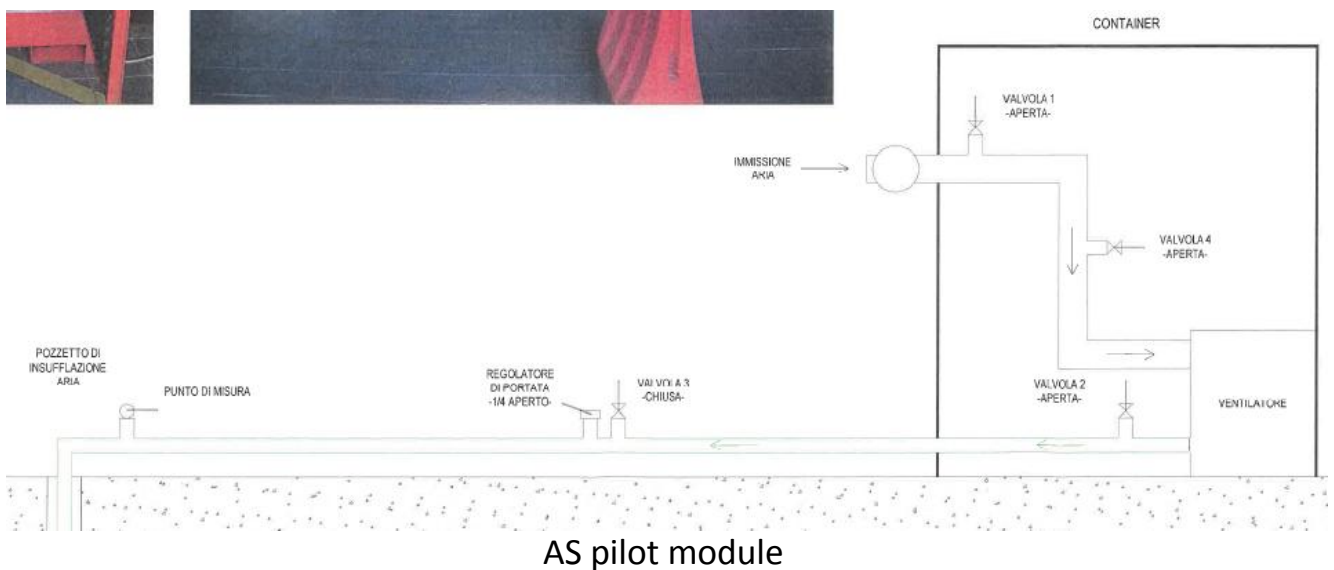

### 3.3 Radius of influence

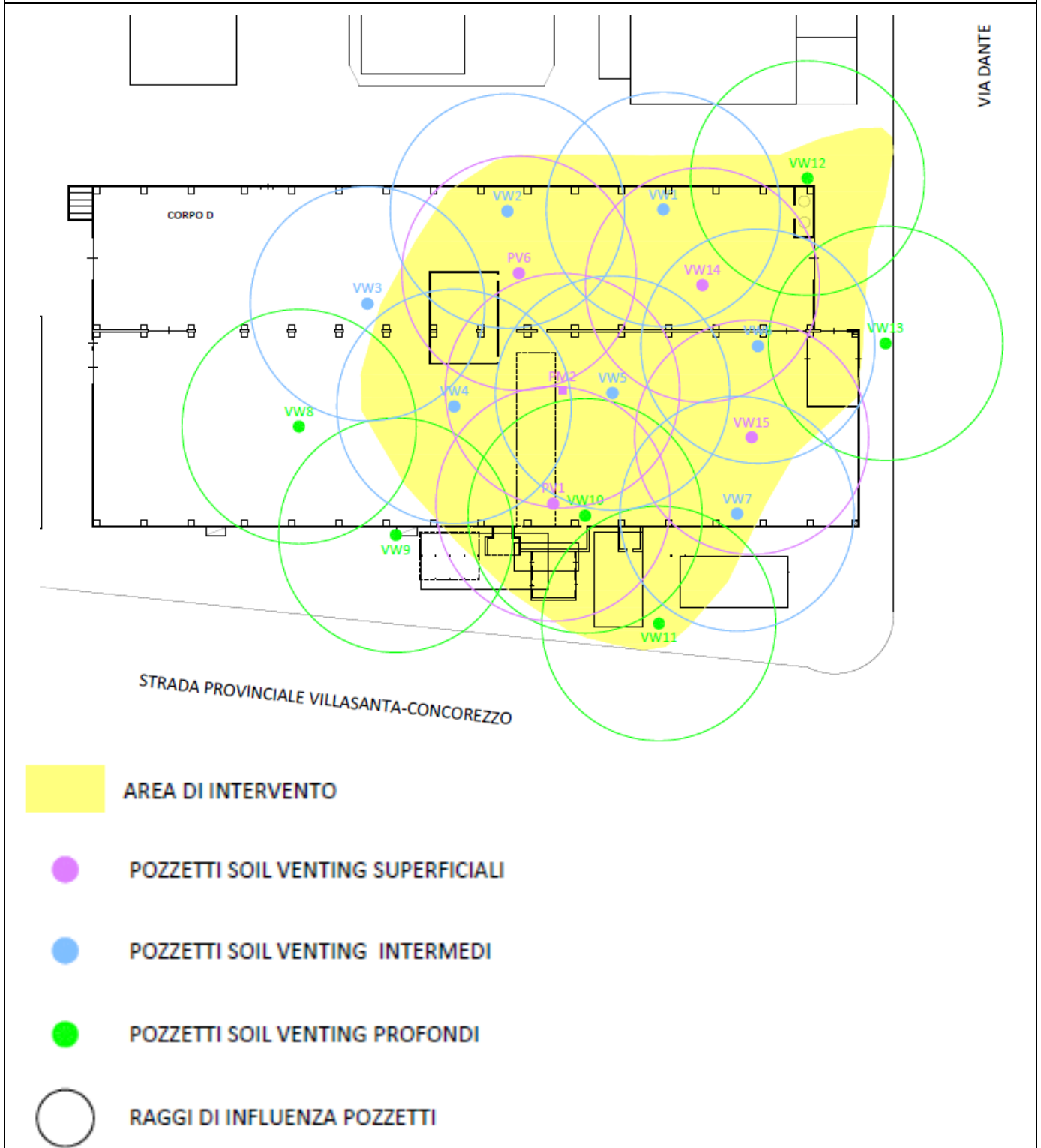





On the basis of the bibliographic data already present for the site and in particular those derived from the implementation of the previous reclamation project, from the stratigraphic observations carried out during the investigations and from the pilot test carried out and described in the previous chapter, it was possible to hypothesize a range of influence for each suction pit equal to 15 m.

The location of the suction points has been selected in such a way that the respective rays of influence are sufficiently coalescing and there are no unaffected areas within the area to be reclaimed.

### **3.4 Off gas Treatment**

As a real pilot phase was not foreseen for the development of the SVE system (it should be remembered that there was a monitoring system of interstitial gases built in application of regional legislation on site for some time and before the planning of the reclamation interventions), the gaseous effluent treatment system corresponds to that envisaged by the operational reclamation interventions when fully operational.

In this regard, see the answer to question 4.4

## 4. Full-scale application

### 4.2 Injection system





## 4.4 Off gas Treatment

Based on the characteristics and functions of the wells, these were connected to two separate suction systems integrated with attached activated carbon filters.

The vapours deriving only from the "short" suction wells with an indicative flow rate of 250 m<sup>3</sup>/h were collected in plant 1.

The vapours deriving from the "intermediate" and "long" suction wells were collected in plant 2 with a total suction flow rate of 650 m<sup>3</sup>/h (approximately 50 m<sup>3</sup>/h for each suction well).

A condensate separator was provided prior to the connection to the activated carbon filter.

The following are the characteristics of the activated carbon filter:

- Estimated gas flow: 650 m<sup>3</sup>/h;
- Filtering surface: 3.0 m<sup>2</sup>;
- Filter material volume: 7.0 m<sup>3</sup>/h;
- Contact time: 38.77 s;
- Filtration speed: 0.06 m/s;
- Active carbon quantity: 4,000 kg;
- Filter layer height: 2,800 mm;
- Inlet/outlet pipe diameter: 100 DN



## 4.5 Control parameters

Describe the monitoring plan designed to evaluate the effectiveness of SVE in the three dimensions. List the control parameters considered.

The direct verification of the radius of influence of the venting wells was carried out through 3 monitoring wells with a depth of 8 m from a pc, equipped with a 2 "PVC pipe, blind for the first 2 m and micro-slotted at -2 m at the bottom of the hole. The perforation-pipe cavity was filled with selected silicon gravel in the micro-cracked sections and with cement/bentonite grout in the blind top sections.

The monitoring operations include both on-site analyses, using portable instrumentation, and laboratory gas chromatographic analyses, by taking air samples from activated carbon vials, in order to calibrate the analyses performed on site.

The following parameters were determined on site, both refer to the entire system (measurement point at the collector) and to the individual wells:

- Air speed (m/s) by means of hot wire anemometer;
- Air temperature (° C) by means of a thermo hygrometer;
- Air humidity (%) by means of a thermo hygrometer;
- Depressions realized in the suction wells (mbar) by means of a digital manometer;
- SOV concentrations present in the air stream (ppm) by PID;
- PCE concentrations (ppm) through the use of colorimetric vials of suitable Gastec or similar scale, through sampling at the suction points.



## 6. Post treatment and/or Long Term Monitoring

### 6.1 Post treatment and/or Long Term Monitoring

The system was launched on October 8, 2013; the start-up phase took place in the following two months, during which the SVE and AS plants were activated by successive steps. From 4 December 2013, the plants operated at full capacity until 2 October 2017. During the entire period of operation of the reclamation plants, the functionality checks of the plants themselves and the monitoring of interstitial gases were regularly carried out in correspondence with the SVE wells.

The data collected during the monitoring made it possible to regulate flows and depressions of the plants.

The results obtained from the monitoring with colorimetric vials, on the other hand, gave a more precise indication of the presence of PCE in interstitial gases. Over time the outermost wells were closed, particularly in the westernmost area, where the PCE values were zero, in order to concentrate the area of influence of the SVE in the most critical areas.

As described in the last Technical Report drawn up in August 2017 before the shutdown of the plants, from the results of the monthly monitoring, it was found that:

- in a large area of that subjected to remediation, including the west, north-central and south-east corner, the PCE values in the measured soil gases reached concentrations close to or equal to zero, starting from July 2014;
- the wells located in the two limited areas of the central-eastern (VW6, VW13, VW14) and central-southern (VW10, VW11) zones also had values below the limit of 10.47 ppm of PCE and close to zero.
- the only point where the PCE was found in concentrations in soil gases close to the reclamation objective, was the VW12, located north-east of the former Battery Department;
- in correspondence with this well, sampling was then carried out by means of ac vials and laboratory analyzes. The analytical data confirmed compliance with the limits set downstream of the risk analysis.

Given the trends in PCE concentrations in the monitored SVE wells, in October 2017 the plants were shut down and the first phase of soil testing was started, by carrying out n. 2 on/off cycles of the systems to check for any rebound phenomena.

As indicated in the act of approval of the subsoil remediation project for the Carrier plant in Villasanta, the remediation objectives for the unsaturated soil matrix can be considered achieved when "... the results of the interstitial gas tests will attest to concentrations lower than 71 mg/m<sup>3</sup> of PCE in all the monitoring wells for at least two



campaigns carried out in different seasonal climatic conditions... "

The first test of unsaturated soil was carried out in 2018 with the two semi-annual sampling campaigns in June and November.

Given the negative results obtained during the second sampling in November 2018, the SVE plants were restarted until April 2019 for a total period of about 5 months and then the absence of rebound phenomena was verified through ignition/shutdown cycles.

The second phase of testing of unsaturated soil was therefore launched, carried out with the two six-monthly samplings respectively in July 2019 and January 2020. The results of the activities carried out in the two testing campaigns certified compliance with the authorized remediation objectives.





## 7. Additional information

### 7.1 Lesson learnt

The interventions that affected the site were carried out by an American multinational which, in line with its corporate policy, paid particular attention in terms of financial resources in the choice of the best performing remediation technology for the type of pollution (PCE) and for the particular site specific conditions (contamination of the unsaturated and saturated, with the presence of more contaminated horizons).

The use of interstitial gas sampling techniques and identification of remediation objectives with concentrations referring to the aeriform matrix present in the unsaturated soil represents one of the first cases of application in Lombardy (the first sampling had already been carried out before 2010, in the absence of guidelines and regulatory guidelines).

It is therefore a reference case study for the development of the pore gas measurement methodology that has been progressively implemented.

The SVE technology, associated with an AS plant and a Pump & Treat system, has been found to be effective in reducing the level of contamination present in the soil and groundwater.

At the administrative level, it is necessary to highlight the difficulties in defining the remediation objectives, considering that the legislation and technical guidelines in force at the time made the use of values in interstitial gases as a reference for site certification with little applicability.

From a technical point of view, it should be noted that the first soil characterization carried out with traditional techniques (sampling of soil by continuous core drilling and laboratory analysis) did not show that the table limits were exceeded, underestimating the actual state of contamination of the site.

The use of data from the measurement of interstitial gases in the second phase of characterization, however, made it possible to ascertain an effective contamination of the unsaturated soil, identifying at the same time the secondary source responsible for the contamination in the groundwater.



## Glossary of Terms

<b>Term (alphabetical order)</b>	<b>Definition</b>
VOC	Volatile organic compounds
SIN	Contaminated site of National Priority List
SIR	site of regional importance
CdS	Conference of Services
CSC	Contamination Threshold Concentrations
CSR	Risk Threshold Concentrations
SVE	Soil Vapor Extraction
AS	Air Sparging
PCE	Perchloroethylene (= Tetrachloroethylene)
TCE	Trielin (= Trichloroethylene)
TCM	Chloroform (= Trichloromethane)
P&T	Pump and Treat