



European Union Network for the Implementation  
and Enforcement of Environmental Law



Working Group  
Contamination

# In situ chemická oxidácia (ISCO)

---

*Záverečná správa*

**Date of report: 8. novembra 2021**

**Report number: 2020/09 ISCO SK**

## Úvod o IMPEL

Sieť Európskej únie pre implementáciu a presadzovanie práva životného prostredia IMPEL (z angl. The European Union Network for the Implementation and Enforcement of Environmental Law) je medzinárodné neziskové združenie orgánov životného prostredia členských štátov EÚ, prístupujúcich a kandidátskych krajín Európskej únie a krajín Európskeho hospodárskeho priestoru (European Economic Area – EEA). Združenie je registrované v Belgicku a jeho právne sídlo je v Bruseli v Belgicku.

IMPEL bola založená v roku 1992 ako neformálna sieť európskych regulátorov a orgánov zaoberajúcich sa implementáciou a presadzovaním environmentálneho práva. Cieľom siete je vytvoriť v Európskom spoločenstve potrebný stimul na dosiahnutie pokroku pri zabezpečovaní efektívnejšieho uplatňovania právnych predpisov v oblasti životného prostredia. Jadro aktivít siete IMPEL sa týka zvyšovania povedomia, budovania kapacít a výmeny informácií a skúseností v oblasti implementácie, presadzovania a medzinárodnej spolupráce pri presadzovaní, ako aj podpory realizovateľnosti a vymožitelnosti európskej environmentálnej legislatívy.

Počas predchádzajúcich rokov sa IMPEL rozvinula na významnú, všeobecne známu organizáciu, o ktorej sa zmieňuje množstvo legislatívnych a politických dokumentov EÚ, napr. 7. environmentálny akčný program a odporúčanie o minimálnych kritériách pre environmentálne inšpekcie.

Odbornosť a skúsenosti účastníkov v rámci IMPEL robia sieť jedinečne kvalifikovanou na prácu na technických aj regulačných aspektoch environmentálnej legislatívy EÚ.

Informácie o sieti IMPEL sú dostupné aj prostredníctvom jej webovej stránky na adrese: [www.impel.eu](http://www.impel.eu)

### Suggested citation:

Falconi M. et al. (2021), In situ chemická oxidácia (ISCO), Záverečná správa. IMPEL, COMMON FORUM, EIONET, NICOLE report no 2020/09 ISCO SK, 277 pages. Brussels, ISBN 978-2-931225-07-3

ISBN 978-2-931225-07-3



9 782931 225073

<b>Názov správy:</b> In situ chemická oxidácia (ISCO) In Situ Chemical Oxidation (ISCO) report	<b>Číslo správy:</b> 2020/09 ISCO SK	
<b>Report adopted at IMPEL General Assembly Meeting</b> 7.-8. decembra 2021, Ľubľana (Slovinsko)	<b>Celkový počet strán: 277</b> <b>Správa: 54 strán Prílohy:</b> 223 strán	
<b>Projektoví manažéri:</b>		
Marco Falconi (IT)	IMPEL	ISPRA
Dietmar Müller-Grabherr (AT)	Common Forum	Umweltbundesamt AT
Frank Swartjes (NL)	EIONET WG Contamination	RIVM
Tomas Albergaria (PT)	NICOLE	Instituto Politécnico do Porto
<b>Autori:</b>		
Frank Swartjes (NL)	EIONET WG Contamination	RIVM
Francesca Benedetti (IT)	IMPEL	MITE (Consultant)
Emanuela Fabbrizi (IT)	IMPEL	ARPAE
Marco Falconi (IT)	IMPEL	ISPRA
Gabriella Grima (MT)	IMPEL	ERA
Daniel Gruza (CZ)	IMPEL	CIPZ
Maria Mallada (ES)	IMPEL	LA RIOJA
Katarina Paluchova (SK)	-	SEA
Christina Pisani (MT)	IMPEL	ERA
Alex Plows (UK)	IMPEL	CYFOETHNATURIOLCYMRU
Roberto Riberti (IT)	IMPEL	ARPAE
Jaroslav Schwarz (SK)	-	SEA
Paola Siligardi (IT)	IMPEL	ARPAE
Asa Valley (SE)	EIONET WG Contamination	NATURVÅRDSVERKET
Alena Vengrinova (SK)	-	SEA
<b>Prispievatelia do prílohy 1 ISCO:</b>		
Simone Biemmi (IT)	ARCADIS ITALIA	
Gordon H. Bures (DE)	SENSATEC	
Federico Caldera (IT)	MARES	
Marcello Carboni (IT)	REGENESIS	
Massimiliano Confalonieri (IT)	ARPA LOMBARDIA	
Mara Dal Santo (IT)	STANTEC	
Federica Danesin (IT)	ARPAV	
Uwe Dannwolf (DE)	RISKCOM	
Federica De Giorgi (IT)	GOLDER ASSOCIATES	
Boris Devic-Bassaget (FR)	SUEZ RR IWS REMEDIATION FRANCE	
Hans-Georg Edel (DE)	ZÜBLIN UMWELTTECHNIK	
Peter Freitag (AT)	KELLER GRUNDBAU	
Alberto Leombruni (IT)	EVONIK	
Camille Lorant (FR)	SUEZ RR IWS REMEDIATION FRANCE	
Angela Rosa Marin (IT)	ARPA LOMBARDIA	
Juan Marti (ES)	SUEZ RR IWS IBERICA	
Mike Mueller (AT)	EVONIK	
Harald Opdam (NL)	HEIJMANS INFRA BV	

Sara Puricelli (IT)	ARPA LOMBARDIA
Diego Ricci (IT)	ARPA LOMBARDIA
Hadas Sharon (IL)	LUDAN ENVIRONMENTAL TECHNOLOGIES
Valentina Sammartino (IT)	ARPA CAMPANIA
Christelle Tarchalski (FR)	ARTELIA
Laura Valeriani (IT)	GOLDER ASSOCIATES

**Recenzenti:**

Gordon H. Bures (DE)	SENSATEC
Marcello Carboni (IT)	REGENESIS
Uwe Dannwolf (DE)	RISKCOM
Mara Dal Santo (IT)	STANTEC
Harald Opdam (NL)	HEIJMANS INFRA BV

**Zhrnutie**

*Kľúčové slová*

Chemická oxidácia in situ, udržateľná sanácia, pôda, podzemná voda, pôdna politika, sanácia, životné prostredie, žiadny záber pôdy, znečistenie, znečistené lokality, znečistené územie, monitorovanie, terénne skúšky.

*Cieľové skupiny*

Príslušné orgány pre schvaľovanie/aplikáciu/monitorovanie sanačných metód, priemyselní prevádzkovatelia, orgány ochrany životného prostredia, orgány ochrany prírody, inšpektoráty životného prostredia, monitorovacie a výskumné inštitúcie, technické univerzity, environmentálne združenia, mimovládne organizácie, poisťovne a združenia, environmentálni poradcovia.

Združenie IMPEL v rámci svojho pracovného programu na rok 2020 vytvorila projekt týkajúci sa posúdenia použiteľnosti sanačných metód (2020/09).

Projekt „Sanácia vody a pôdy“ vychádza z definícií a postupov sanácie a zameriava sa na technickú stránku sanačných technológií. Konečným cieľom projektu je vytvoriť dokument poskytujúci kritériá pre posúdenie návrhu sanačnej technológie, posúdiť jej vhodnosť, popísať postup pri terénnych skúškach a samotnej sanácii. Príloha 1 obsahuje niekoľko prípadových štúdií, ktoré môžu pomôcť čitateľom pripraviť sa na problémy, s ktorými sa môžu stretnúť, a tiež zistiť, či sa prezentované riešenie môže použiť na ich lokalite. Pritom zostáva v platnosti, že každá znečistená lokalita sa líši od ostatných a vždy je potrebný špecifický prístup pre danú lokalitu.

Cieľom projektu „Sanácia vody a pôdy“ na roky 2020 – 2021 bolo sústrediť sa na dve sanačné technológie, chemickú oxidáciu in situ a extrakciu pôdneho vzduchu.

Projekt „Sanácia vody a pôdy“ má za cieľ podporiť použitie in situ a on-site sanačných technológií pre pôdu, horninové prostredie a podzemnú vodu, na úkor bežne používaných technológií Dig & Dump (odstránenie znečistenej zeminy a jej sanácia ex situ) a Pump&Treat (sanačné čerpanie a čistenie podzemnej vody), ktoré nie sú trvalo udržateľné v strednodobom horizonte. Pôda, horninové prostredie a voda sú prírodnými zdrojmi, a pokiaľ je to technicky možné, mala by sa dosiahnuť ich obnova a nie plytvanie.

**Poďakovanie**

Správu odborne posúdil širší projektový tím IMPEL a skupina expertov IMPEL pre vodu a pôdu, členovia Common Fóra, NICOLE, pracovná skupine EIONET pre znečistenie a skupina externých posudzovateľov.



# Zrieknutie sa zodpovednosti

---

Táto publikácia bola spracovaná v rámci IMPEL (European Union Network for the Implementation and Enforcement of Environmental Law) projektu s názvom „Sanácia vody a pôdy“ (Water & Land Remediation), s podporou skupiny partnerov, ktorí sa zaujímajú o manažment znečistenej pôdy. Dokument, ktorý napísal a zhodnotil tím autorov, má slúžiť ako primárny zdroj informácií na premostenie a rozšírenie poznatkov medzi európskymi krajinami a regiónmi. Zameriava sa na podporu spoločného chápania potenciálu špecifickej sanačnej metódy.

Uvedený obsah vychádza z príslušnej bibliografie, skúseností autorov a zozbieraných prípadových štúdií. Dokument nemusí byť vyčerpávajúci vo všetkých prípadoch, v ktorých bola alebo bude táto metóda použitá. Prípadové štúdie (viď. príloha) sú uznanými dobrovoľnými príspevkami. Kolektív autorov nemal za úlohu vyhodnocovať a overovať správy o prípadových štúdiách.

Niektoré krajiny, regióny alebo miestne orgány môžu zaviesť osobitné právne predpisy, metodické pokyny alebo usmernenia, ktoré stanovujú uplatňovanie metódy a jej použiteľnosť.

Tento dokument NIE JE metodickou príručkou pre uvedenú sanačnú metódu a tiež nie je referenčným dokumentom (BREF – BAT reference document) pre najlepšie dostupné techniky (BAT - best available techniques). Pedologická, geologická a hydrogeologická charakteristika prostredia znečistených území v Európe vykazuje veľkú variabilitu. Preto je pre úspech pri sanácii znečistených území kľúčový návrh a realizácia, ktoré sú prispôbené konkrétnej lokalite. Takže každé uvedené odporúčanie sa môže buď uplatniť, čiastočne uplatniť alebo aj neuplatniť. V každom prípade autori, prispievatelia a zapojené inštitúcie nenesú za to zodpovednosť.

Názory vyjadrené v tomto dokumente sa nemusia stotožňovať s názormi jednotlivých zúčastnených členov. IMPEL a jeho skupina partnerov dôrazne odporúčajú, aby jednotlivci/organizácie, ktorí majú záujem o zavedenie metódy v praxi, využili služby skúsených odborníkov v oblasti životného prostredia.

Marco Falconi – IMPEL

Dietmar Müller Grabherr – COMMON FORUM on Contaminated Land in Europe

Frank Swartjes – EEA EIONET WG Contamination

Tomas Albergaria – NICOLE

# Slovník pojmov

TERM	DEFINITION	SOURCE	PARAGR.
'compliance point'	location (for example, soil or groundwater) where the assessment criteria shall be measured and shall not be exceeded	ISO EN 11074	3.4.5
'compliance or performance control'	investigation or program of on-going inspection, testing or monitoring to confirm that a remediation strategy has been properly implemented (for example, all contaminated have been removed) and/or when a containment approach has been adopted, that this continues to perform to the specified level	ISO EN 11074	6.1.5
'contaminant' <sup>1</sup>	substance(s) or agent(s) present in the soil as a result of human activity	ISO EN 11074	3.4.6
'contaminated site' <sup>2</sup>	site where contamination is present	ISO EN 11074	2.3.5
'contamination'	substance(s) or agent(s) present in the soil as a result of human activity	ISO EN 11074	2.3.6
'effectiveness' <sup>3</sup>	<remediation method> measure of the ability of a remediation method to achieve a required performance	ISO EN 11074	6.1.6
'emission'	the direct or indirect release of substances, vibrations, heat or noise from individual or diffuse sources in the installation into air, water or land;	IED	Art. 3 (4)
'environmental quality standard'	the set of requirements which must be fulfilled at a given time by a given environment or particular part thereof, as set out in Union law;	IED	Art. 3 (6)
'Henry's coefficient'	partition coefficient between soil air and soil water	ISO EN 11074	3.3.12
' <i>in-situ</i> treatment method' <sup>4</sup>	treatment method applied directly to the environmental medium treated (e.g. soil, groundwater) without extraction of the contaminated matrix from the ground	ISO EN 11074	6.2.3
'leaching'	dissolution and movement of dissolved substances by water	ISO EN 11074	3.3.15

<sup>1</sup> There is no assumption in this definition that harms results from the presence of contamination

<sup>2</sup> There is no assumption in this definition that harms results from the presence of contamination.]

<sup>3</sup> In the case of a process-based method, effectiveness can be expressed in terms of the achieved residual contaminant concentrations.

<sup>4</sup> Note: ISO CD 241212 suggests as synonym: 'in-situ (remediation) technique' [Note 1 to entry: Such remediation installation is set on site and the action of treating the contaminant is aimed at being directly applied on the subsurface.] ISO CD 24212 3.1

'pollutant'	substance(s) or agent(s) present in the soil (or groundwater) which, due to its properties, amount or concentration, causes adverse impacts on soil functions	ISO EN 11074	3.4.18
'pollution'	the direct or indirect introduction, as a result of human activity, of substances, vibrations, heat or noise into air, water or land which may be harmful to human health or the quality of the environment, result in damage to material property, or impair or interfere with amenities and other legitimate uses of the environment;	IED	Art. 3 (2)
'remediation objective'	generic term for any objective, including those related to technical (e.g. residual contamination concentrations, engineering performance), administrative, and legal requirements	ISO EN 11074	6.1.19
'remediation strategy' <sup>5</sup>	combination of remediation methods and associated works that will meet specified contamination-related objectives (e.g. residual contaminant concentrations) and other objectives (e.g. engineering-related) and overcome site-specific constraints	ISO EN 11074	6.1.20
'remediation target value'	indication of the performance to be achieved by remediation, usually defined as contamination-related objective in term of a residual concentration	ISO EN 11074	6.1.21
'saturated zone'	zone of the ground in which the pore space is filled completely with liquid at the time of consideration	ISO EN 11074	3.2.6
'soil'	the top layer of the Earth's crust situated between the bedrock and the surface. Soil is composed of mineral particles, organic matter, water, air and living organisms;	IED	Art. 3 (21)
'soil gas'	gas and vapour in the pore spaces of soils	ISO EN 11074	2.1.13
'unsaturated zone'	zone of the ground in which the pore space is not filled completely with liquid at the time of consideration	ISO EN 11074	3.2.8

<sup>5</sup> The choice of methods might be constrained by a variety of site-specific factors such as topography, geology, hydrogeology, propensity to flood, and climate

# OBSAH

---

<b>1</b>	<b>ÚVOD</b>	<b>10</b>
<b>2</b>	<b>OPIS METÓDY</b>	<b>13</b>
2.1	Fázy sanácie ISCO	14
2.2	Vlastnosti znečisťujúcich látok ťažších ako voda (DNAPL)	16
2.2.1	Prchavosť znečisťujúcich látok ťažších ako voda	17
2.3	Oxidácia znečisťujúcich látok	17
2.3.1	Oxidačné činidlo	18
2.3.1.1	Manganistan draselný (KMnO <sub>4</sub> )	18
2.3.1.2	Peroxid vodíka (H <sub>2</sub> O <sub>2</sub> )	20
2.3.1.3	Ozón (O <sub>3</sub> )	20
2.3.1.4	Persíran sodný alebo vápenatý	21
2.4	In situ chemická oxidácia (ISCO) v kontexte	22
<b>3</b>	<b>ŠTÚDIA USKUTOČNITEĽNOSTI</b>	<b>26</b>
3.1	Vymedzenia cieľa sanácie	26
3.2	Aplikovateľnosť sanácie ISCO	26
3.2.1	Spotreba oxidačných činidiel	28
3.2.2	Geologická a hydrogeologická charakteristika lokality	30
3.2.3	Prítomnosť infraštruktúry	31
3.3	Podrobné posúdenie uskutočniteľnosti sanácie	31
3.4	Reaktivita znečisťujúcich látok	33
<b>4</b>	<b>TERÉNNA / LABORATÓRNA SKÚŠKA</b>	<b>34</b>
4.1	Obsah technického návrhu sanácie	34
4.1.1	Výber typu oxidačného činidla	34
4.1.1.1	Reakčná kinetika	34
4.1.1.2	Geológia a hydrogeológia	35
4.1.1.3	Spotreba kyslíka v podzemnej vode a vodonosnej vrstve (NOD)	35
4.1.1.4	pH	36
4.1.1.5	Frakcia organického uhlíka (foc)	36
4.1.1.6	Koncentrácia znečisťujúcej látky	37
4.1.1.7	Environmentálne aspekty použitia oxidačných činidiel	37
4.1.2	Množstvo oxidačného činidla	38
4.1.2.1	Spotreba oxidantu znečisťujúcimi látkami	38

4.1.2.2	Hmota hornín	38
4.1.2.3	Stanovenie spotreby oxidačných činidiel	38
4.1.3	Spôsob aplikácie sanačných roztokov	39
4.1.4	Objem injektovaného činidla	39
4.1.5	Dostupnosť oblasti sanačného zásahu	39
4.1.6	Metódy injektáže	39
4.2	Laboratórne a pilotné skúšky	45
4.2.1	Laboratórne skúšky	46
4.2.2	Pilotná skúška	46
4.2.3	Monitorovanie procesu sanácie	47
4.2.4	Monitorovanie priebehu sanácie	47
4.2.4.2	Monitorovacia sieť	48
4.2.4.3	Frekvencia monitorovania	49
5	MONITOROVANIE	50
5.1	Typy skúšok	50
5.2	Typy monitorovania	51
5.2.1	Prevádzkovo-technologické monitorovanie	51
5.2.2	Priebežné a záverečné monitorovanie	51
5.2.3	Posačné monitorovanie	52
5.2.4	Spracovanie aktualizovanej analýzy rizika po ukončení sanácie	52
6	ZÁVER	53
	POUŽITÁ LITERATÚRA	54

## 1 ÚVOD

In situ chemická oxidácia (ISCO) je často používaná sanačná metóda, vzhľadom na jej použiteľnosť pre širokú škálu znečisťujúcich látok. Metóda spočíva v injektáži oxidačných činidiel, ako sú manganistan, persíran a peroxid vodíka, do horninového prostredia, aby sa znečisťujúce látky oxidovali na neškodné zlúčeniny.

ISCO dokáže úspešne odbúrať znečisťujúce látky, ako sú chlórované rozpúšťadlá, ropné uhľovodíky, BTEX (benzén, toluén, etylbenzén a xylény), metylterbutyléter (MTBE), fenoly, polycyklické aromatické uhľovodíky (PAU) a chlórbenzény.

Už vieme, že medzi týmito znečisťujúcimi látkami a oxidačnými činidlami dochádza k oxidácii, ale je potrebné kontrolovať mnoho parametrov. Výber tejto sanačnej metódy si vyžaduje špecifické znalosti o lokalite, o znečisťujúcich látkach, o ich rozložení v horninovom prostredí a podzemnej vode, o geologickej a hydrogeologickej charakteristike lokality. Každá lokalita má svoj vlastný systém ISCO "šitý na mieru". Často sa stáva, že výber metódy sa realizuje po predbežnej špecifikácii bez toho, aby boli k dispozícii podrobné informácie, s cieľom ušetriť čas a rýchlo začať so sanáciou. Skúsenosti z niekoľkých desaťročí sanácií lokalít nám ukázali, že na výber správnej metódy pre dané podmienky je potrebné spracovať projekt sanácie (vrátane pilotných skúšok) a nevychádzať len zo všeobecných informácií o distribúcii znečisťujúcich látok alebo geologickej stavbe lokality. Životný cyklus sanácie ISCO s vypracovaním projektu a koncepčného modelu a bez neho z hľadiska vynaložených nákladov je znázornený na obrázku 1.1.

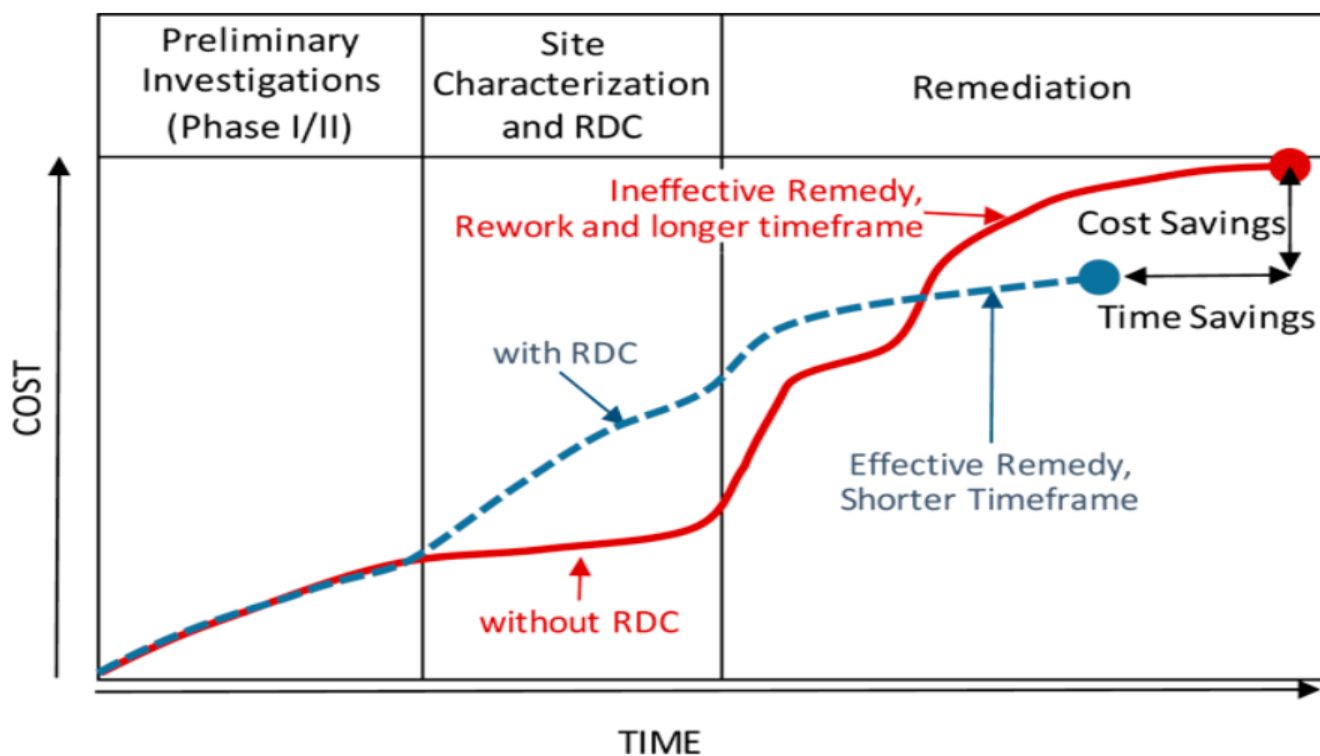

*COST* – náklady, *TIME* – čas, *Preliminary Investigations (Phase I/II)* – orientačný prieskum, *Site Characterization and RDC* – podrobný / predsanačný prieskum a návrh sanácie, *Remediation* – sanácia, *Ineffective Remedy, Rework and longer timeframe* – neefektívna sanácia, prepracovanie a dlhší čas, *with RDC* – vrátane návrhu sanácie (a pilotných skúšok), *without RDC* – bez návrhu sanácie (a pilotných skúšok), *Effective Remedy, Shorter Timeframe* – efektívna sanácia, kratší čas, *Cost / Time Savings* – úspora nákladov / času

**Obrázok 1.1- Životný cyklus sanácie ISCO so zahrnutím projektovania (vrátane pilotných skúšok) a bez nich z hľadiska nákladov**

V uvedenej schéme je znázornený pozitívny vplyv projektovania (vrátane pilotných skúšok) na skrátenie času a obmedzenie nákladov na celú sanáciu, aj keď nárast počiatkových nákladov v dôsledku dôkladnej prípravnej fázy je zjavný.

Týmto procesom sa teda získavajú informácie, ktoré sú užitočné pre priebeh sanácie ISCO na lokalite; veľmi užitočné môže byť rozdelenie prípravy sanácie do postupných krokov, ktoré sú znázornené na obrázku 1.2.

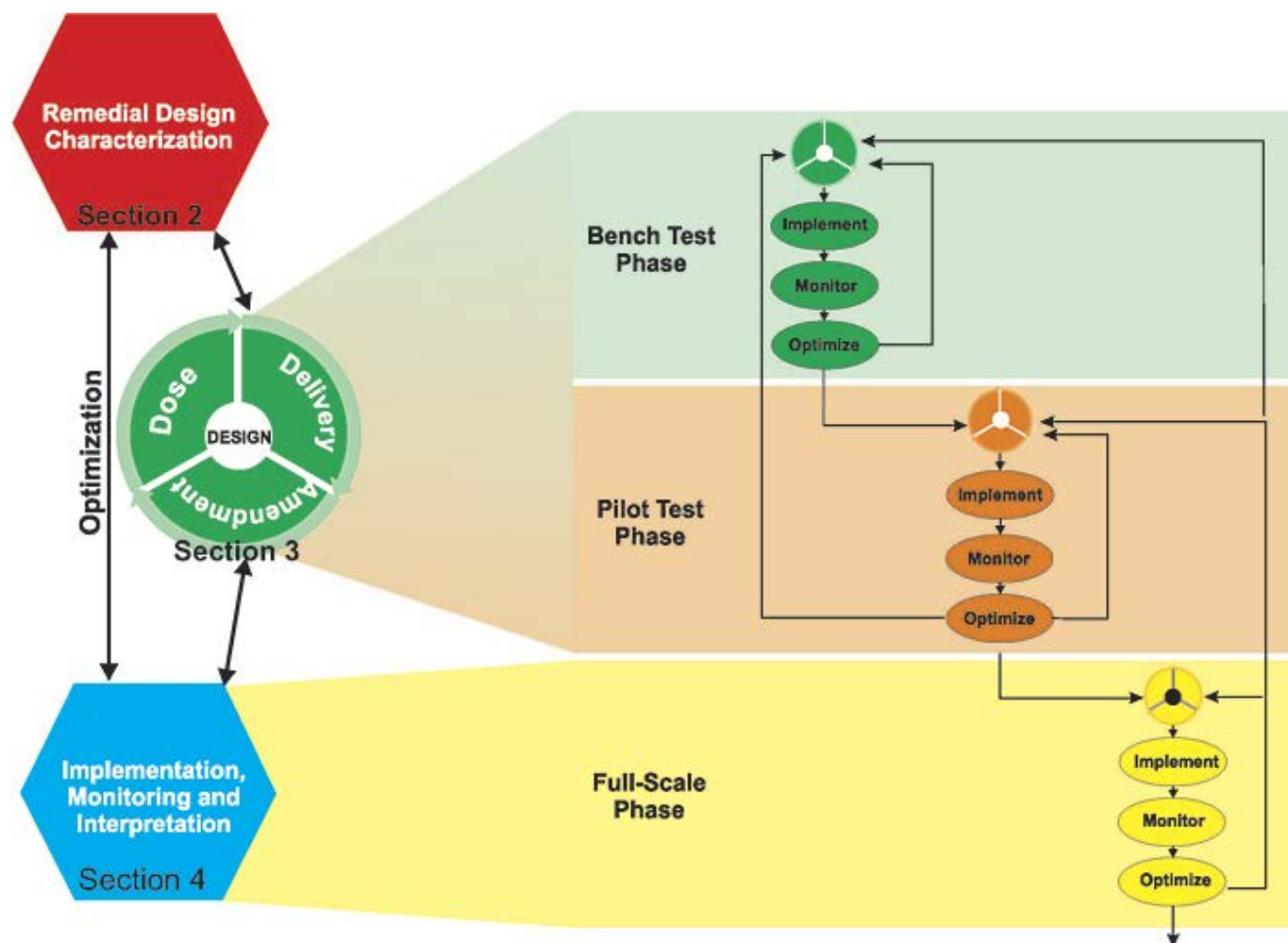

*Bench Test Phase* – etapa laboratórnych výskumov, *Pilot Test Phase* – etapa terénnych (pilotných) skúšok, *Full-Scale Phase* – realizačná etapa, *Remedial Design Characterization* – projekt / návrh sanácie, *Dose* – *Delivery* – *Amendment* – dávka – spôsob distribúcie – úpravy, *Optimization* – optimalizácia, *Implementation, Monitoring and Interpretation* – realizácia, monitorovanie a záverečná správa

Obrázok 1.2- Schéma z ITRC (<https://ois-isrp-1.itrcweb.org/>)

ISCO sa môže použiť aj v kombinácii s inými metódami s rôznymi úrovňami intenzity a vzhľadom na environmentálnu, sociálnu a ekonomickú udržateľnosť je vhodnejšie plánovať viac ako jeden sanačný scenár s rôznym výkonom (obrázok 1.3). Alternatívne návrhy sanácie zohľadňujú kombináciu sanačných metód, na základe ich priestorového rozmiestnenia (rôzne techniky na rôznych častiach lokality) alebo ich použitia v čase (postupnosť metód v tej istej časti lokality), viď. Obrázok 1.4. Intenzita sanačného zásahu sa líši podľa rôznych kombinácií prístupov aktívnych a pasívnych sanačných techník. Aktívne sanačné techniky sú založené na postupoch s potrebou vysokého množstva energie a chemických činidiel, zatiaľ čo pasívne sanačné techniky zahŕňajú biologické (atenuačné) metódy.

Tento integrovaný prístup zvyčajne vytvára synergické účinky na celý proces sanácie.

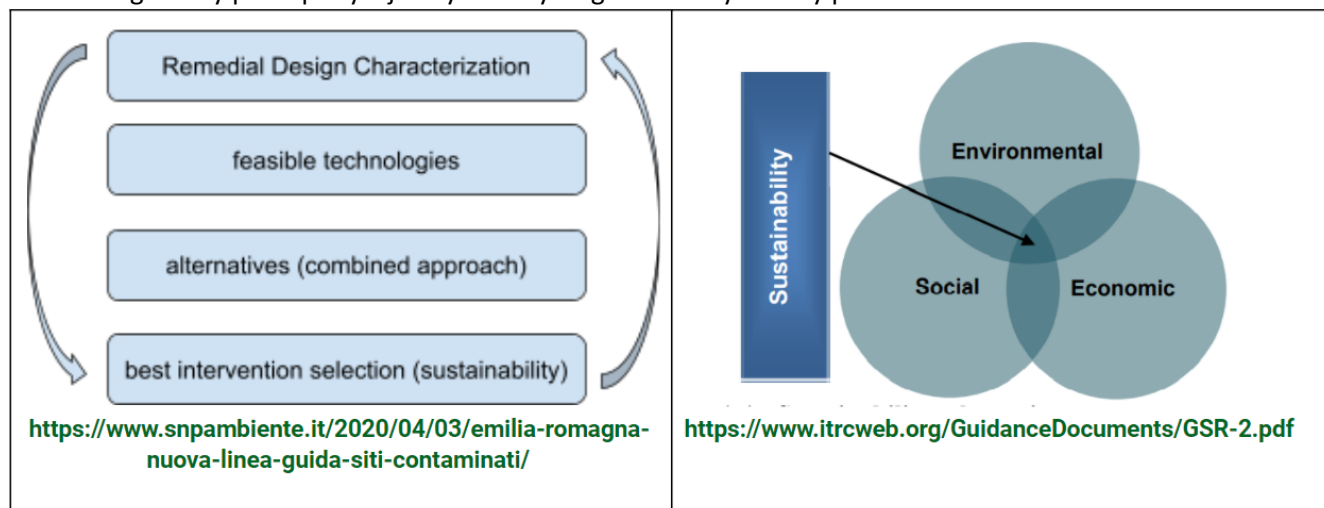

*Remedial Design Characterization* – projekt / návrh sanácie, *feasible technologies* – uskutočniteľné techniky / technológie, *alternatives (combined approach)* – alternatívy, kombinovaný prístup, *best intervention selection (sustainability)* – najlepší výber intervencie (udržateľnosť), *Sustainability – Environmental / Social / Economic* – Udržateľnosť – environmentálna / sociálna / ekonomická

Obrázok 1.3- Schéma udržateľnosti

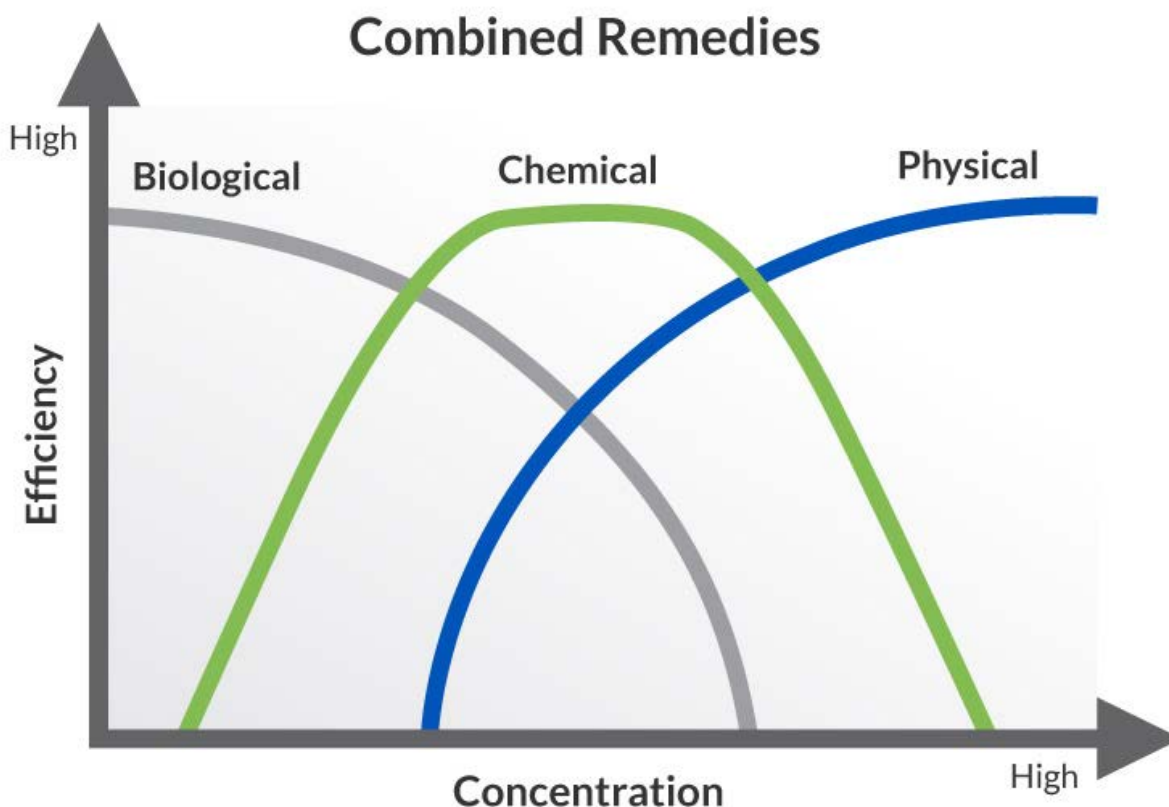

*Efficiency* – účinnosť, *Concentration* – koncentrácia, *Combined Remedies* – kombinované metódy sanácie, *Biological / Chemical / Physical* – biologické / chemické / fyzikálne, *High* – vysoká

Obrázok 1.4- Schéma integrovaného použitia (kombinácie) sanačných metód (©Regenesis 2016)

V nasledujúcich kapitolách je opísaná metóda ISCO a najdôležitejšie kroky, ktoré je potrebné vykonať na dosiahnutie cieľov sanácie. Obsiahnuté informácie sú výsledkom dlhoročných výskumov a praktických skúseností.



## 2 OPIS METÓDY

Metódy sanácie horninového prostredia in situ sa zaoberajú znečistením horninového prostredia a podzemnej vody bez potreby odťažby alebo odberu podzemnej vody. Keďže nie sú potrebné výkopy, tieto metódy majú menší dopad na využitie zeme a môžu byť aplikované na rôznych lokalitách. Menší dopad majú tiež na zloženie a štruktúru pôdy a horninového prostredia.

Metóda ISCO využíva chemické látky, tzv. oxidačné činidlá (napr. manganistan, persíran, peroxid vodíka, ozón), ktoré pomáhajú zmeniť škodlivé znečisťujúce látky na menej toxické vedľajšie produkty chemických reakcií. In situ znamená, že sa činnosť vykonáva na mieste bez toho, aby došlo k vyťaženiu zeminy alebo odčerpaniu podzemnej vody s následným čistením.

Pri aplikácii ISCO sa do horninového prostredia injektuje oxidačné činidlo, ktoré ním prechádza a spôsobuje chemickú deštrukciu (oxidáciu) znečisťujúcich látok, čím sa menia na menej toxické zlúčeniny. Oxidačné činidlá sa aplikujú do horninového prostredia vybranou metódou (opis a princípy aplikačných metód je uvedený v kapitole 4.1.6), takže reagentia sa dostane k znečisteniu. Tým sa môže uplatniť pri odstraňovaní rozpustných aj nerozpustných znečisťujúcich látok. Po aplikácii sa oxidačné činidlo rozptýli do vodonosnej vrstvy, kde sa mieša a reaguje so znečisťujúcimi látkami. Aby sa dosiahol tento cieľ, rozmiestnenie vrtov musí byť také, aby sa zachytilo čo najviac znečistenia a zabezpečila sa tak účinnosť sanácie. Pričom sa pozornosť zameriava na rozpustné aj nerozpustné znečisťujúce látky. Po začerpaní oxidačného činidla do vrtu dochádza k jeho rozptýlu do horninového prostredia a okolitej podzemnej vody, kde sa premiešava a reaguje so znečisťujúcimi látkami.

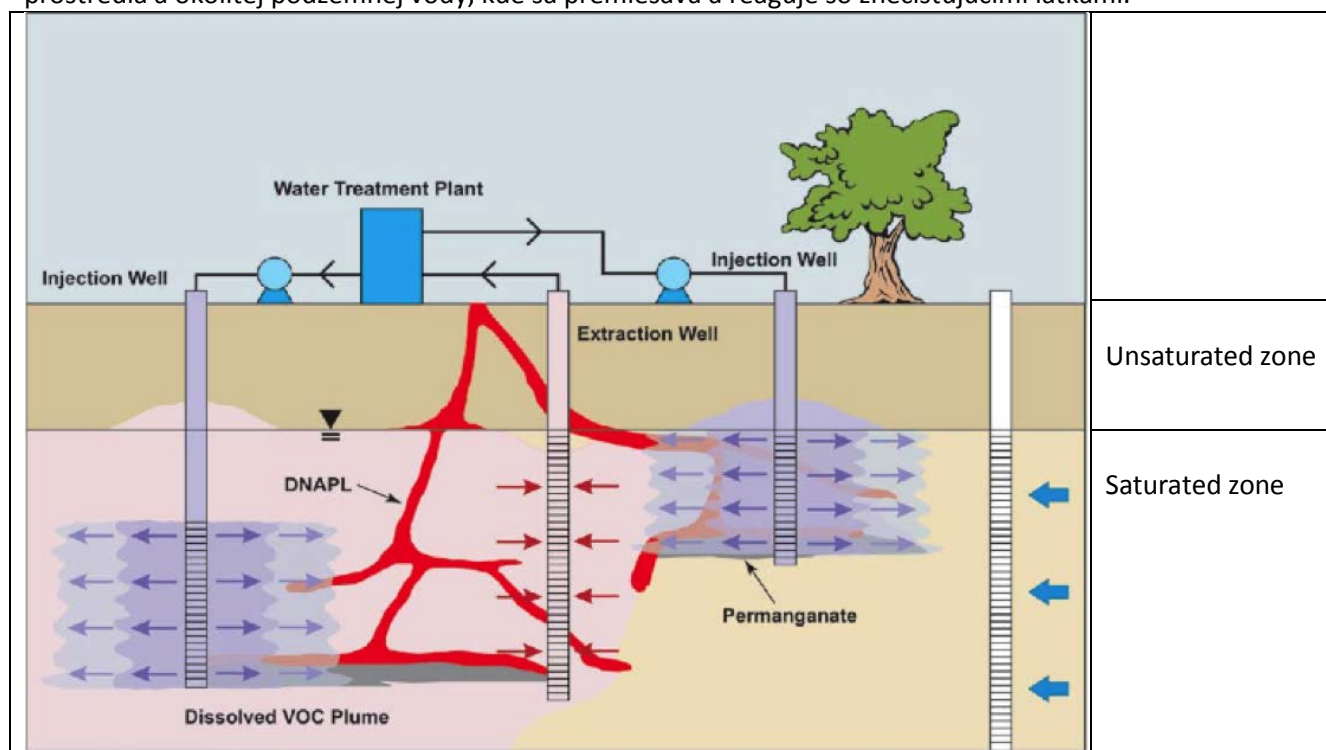

*Unsaturated zone* – nesaturovaná zóna (pásmo prevzdušnenia), *Saturated zone* – saturovaná zóna (pásmo nasýtenia), *Injection Well* – injekčný vrt, *Water Treatment Plant* – čistiareň znečistených vôd, *Extraction Well* – čerpací vrt, *DNAPL* – voľná fáza látok ťažších ako voda, *Permanganate* – hypermangán, *Disolved VOC Plume* – mrak znečistenia prchavými uhľovodíkmi

Obrázok 2.1- Schéma sanácie ISCO

Hlavné výhody tejto metódy sú:

- Výrazne znižuje koncentrácie znečisťujúcich látok na základe cieľov stanovených v rámci sanačnej stratégie.
- Produkt (oxidačné činidlo) sa zavedie do horninového prostredia a rozptýli sa v ňom, spustí chemický rozklad (oxidáciu) znečisťujúcich látok na menej škodlivé chemické látky.
- Štruktúra horninového prostredia zostáva neporušená.

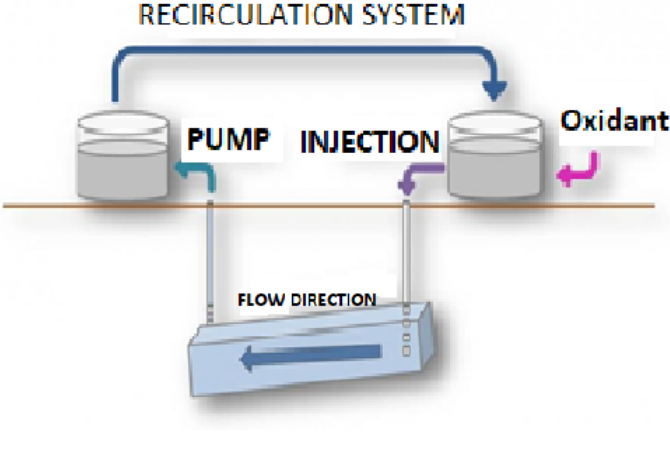
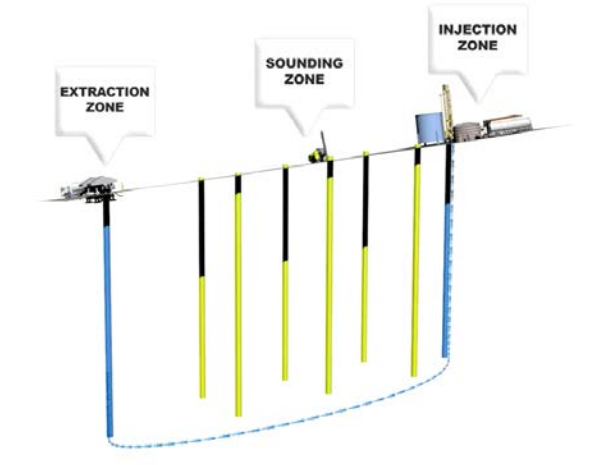
	
<p><b>Obrázok 2.2- Schéma systému recirkulácie</b>  <a href="http://en.lifediscovered.es/content/cats/44/iscours2.jpg">http://en.lifediscovered.es/content/cats/44/iscours2.jpg</a></p>	<p><b>Obrázok 2.3- 2D Schéma systému recirkulácie</b>      LIFE DISCOVERED ISCO pilot trial  <a href="https://www.youtube.com/watch?v=3XjU98hi8KM">https://www.youtube.com/watch?v=3XjU98hi8KM</a></p>
<p>RECIRCULATION SYSTEM – recirkulačný systém, PUMP – čerpadlo, INJECTION – vtláčanie / infiltrácia, Oxidant – oxidačné činidlo, FLOW DIRECTION – smer prúdenia</p>	<p>EXTRACTION ZONE – zóna čerpania, SOUNDING ZONE – zóna sondovania, INJECTION ZONE – zóna vtláčania / infiltrácie</p>

## 2.1 Fázy sanácie ISCO

Správanie sa znečisťujúcej látky v horninovom prostredí a účinnosť sanačnej metódy sú podmienené viacerými faktormi, ktoré sa navzájom ovplyvňujú a závisia od vlastností samotnej znečisťujúcej látky a charakteristiky horninového prostredia. Pre výber metódy s dobrými vyhlídkami na úspech je nevyhnutné zohľadniť vlastnosti znečisťujúcej látky aj znečistenej lokality.

Realizácia sanácie on site môže pozostávať z nasledujúcich fáz:

1. **VYMEDZENIE ÚZEMIA SANÁCIE A ZÁKLADNEJ INFRAŠTRUKTÚRY:** Úspešnosť metódy závisí od optimálneho rozmiestnenia vrtov. Ak nepoznáme optimálne rozmiestnenie vrtov, musí sa vykonať predsanačný prieskum s pilotnými skúškami.
2. **INJEKTÁŽ:** Po odvrtaní sa do vrtu vstrekuje roztok s oxidačným činidlom. Tento roztok prerušuje väzby C-C (uhlíkové) znečisťujúcich látok. Chemickou oxidáciou sa znečisťujúce látky menia na menej nebezpečné a lepšie spracovateľné zlúčeniny.
3. **RECIRKULÁCIA:** Oxidácia znečisťujúcich látok závisí od času zotrvania oxidantu v horninovom prostredí. Keď sa čas kontaktu (oxidant – hornina) považuje za dostatočný, roztok sa prečerpá cez vrt a v prípade potreby sa opäť reinjektuje. Proces recirkulácie prebieha dovtedy, pokiaľ sa nezníži oxidačná kapacita činidla (obrázok 2.4).
4. **EXTRAKCIA:** Účinky sanácie sa zastavia, keď oxidačné činidlo prestane účinkovať a koncentrácia znečisťujúcej látky sa zníži. Následne sa sanačný roztok odčerpá a upraví v príslušnej čistiarni znečistených vôd.
5. **MONITOROVANIE:** Na vyhodnotenie priebehu sanácie ISCO (pred, počas a po ukončení sanácie) a celkového výsledku sanácie je nevyhnutné sledovať parametre, ako sú oxidačno-redukčný potenciál, vodivosť, teplota, oxidanty a ich vedľajšie produkty a koncentrácie znečisťujúcich látok, ktoré sú predmetom sanácie.

Tieto fázy sa môžu alebo nemusia vykonávať postupne.

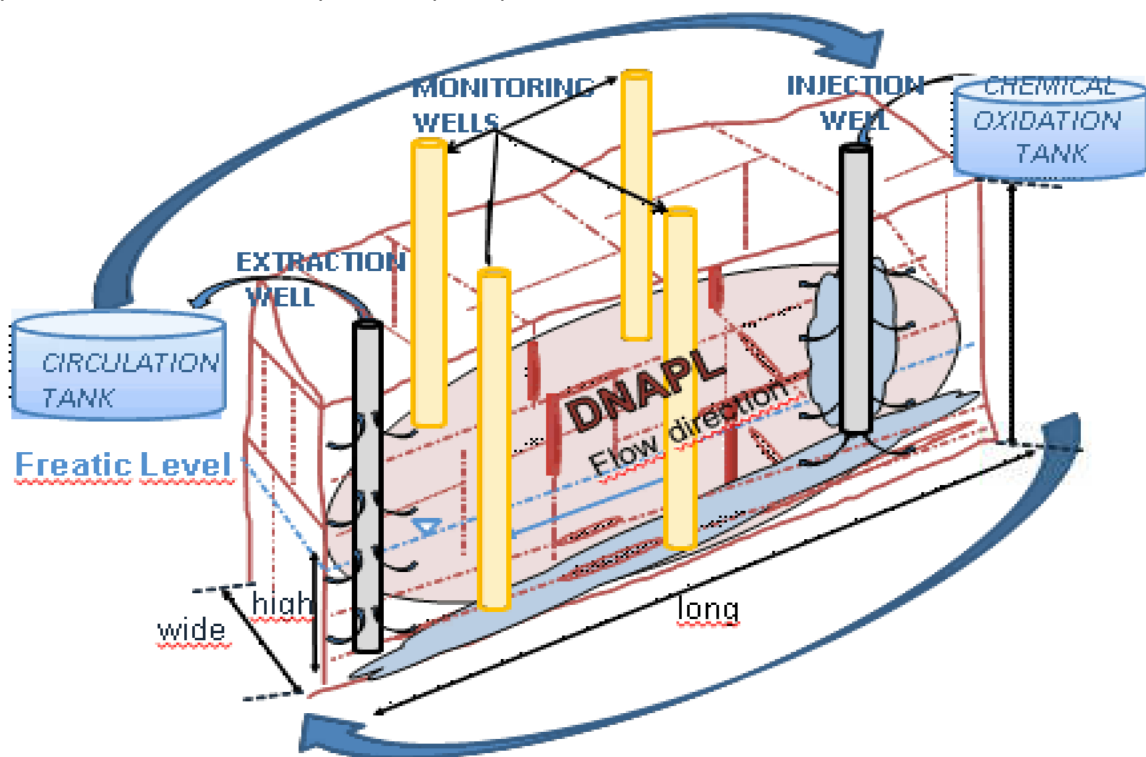

*CIRCULATION TANK* – recirkulačná nádrž, *CHEMICAL OXIDATION TANK* – nádrž s roztokom oxidačného činidla, *Extraction Well* – čerpací vrt, *Monitoring Wells* – monitorovacie vrty, *Injection Well* – injekčný vrt, *Water Treatment Plant* – čistiareň znečistených vôd, *DNAPL* – voľná fáza látok ťažších ako voda. *Flow direction* – smer prúdenia, *Freatic Level* – voľná hladina podzemnej vody, *wide / high / long* – šírka / výška / dĺžka

Obrázok 2.4- 3D Schéma recirkulačného systému sanácie ISCO





## Obrázok 2.5- Zmiešavanie číndiel pred injektážou

### 2.2 Vlastnosti znečisťujúcich látok ťažších ako voda (DNAPL)

Skratka DNAPL pochádza z anglického výrazu “dense liquids in non-aqueous phase”, čo vo voľnom preklade znamená voľná (tekutá) fáza látok ťažších ako voda. DNAPL sú kvapaliny, ktoré sú ťažšie ako voda a sú zároveň s vodou nemiešateľné alebo sú vo vode horšie rozpustné. Tento termín používajú technici, environmentalisti a hydrogeológovia na označenie skupiny znečisťujúcich látok prítomných v povrchovej vode, podzemnej vode alebo horninovom prostredí.

Pojem DNAPL zahŕňa množstvo chemických látok. Medzi najdôležitejšie patria organochlórové rozpúšťadlá (najmä halogénované etény), krezot, zvyšky uhoľného dechtu a niektoré pesticídy. Najčastejšie sa DNAPL na znečistených lokalitách nachádzajú ako organochlórové rozpúšťadlá.

Podľa fyzikálnych a chemických vlastností DNAPL sa do podložia dostávajú vo významných množstvách. V dôsledku toho sa horninové prostredie znečisťuje. DNAPL prestupujú spravidla horninovým prostredím, až sa nakoniec nahromadia na kontakte s nepriepustnými vrstvami. Vysoká mobilita priesakom a zložitost prírodného prostredia (heterogenita) sťažujú lokalizáciu DNAPL. V dôsledku toho je sanácia horninového prostredia a podzemnej vody znečistenými DNAPL náročná.



**Obrázok 2.6- Zmes látok ťažších ako voda vo voľnej fáze (DNAPL)**

Znečisťujúce látky: hexachlórbenzén (HCB), alfa-hexachlórkyklohexán ( $\alpha$ -HCH), beta-hexachlórkyklohexán ( $\beta$ -HCH), lindán a pentachlórbenzén  
<https://www.youtube.com/watch?v=3XjU98hi8KM>

**Obrázok 2.7- Látky ťažšie ako voda vo voľnej fáze (DNAPL) vo vzorke vody**

<http://en.lifediscovered.es>

Riziká spojené s prítomnosťou tohto druhu znečisťujúcej látky v horninovom prostredí sú vysoké. Dôsledky sú ľahko pozorovateľné v strednodobom a dlhodobom horizonte, najmä preto že:

- toxicita znečisťujúcich látok prítomných v DNAPL je vysoká,
- rozpustnosť jednotlivých znečisťujúcich látok je nízka, ale často postačuje na prekročenie povolených prahových hodnôt v pitnej vode, a
- má vysoký migračný potenciál horninovým prostredím aj podzemnou vodou.

Prenikanie DNAPL cez horninové prostredie závisí od spôsobu úniku látky do prostredia, vlastností voľnej tekutej fázy znečisťujúcich látok, ako sú hustota, povrchové napätie, viskozita a pórovitosť prostredia. Infiltráciu ovplyvňujú aj hydraulické sily (zvodnenie prostredia). K migrácii DNAPL dochádza prednostne cez priepustnejšie cesty, ako sú pukliny a zlomy v horninovom masíve, ílovitých horninách alebo cez vysoko priepustné vrstvy.

Detekcia DNAPL vo vzorkách pôdy, hornín a podzemnej vody je náročná kvôli častej absencii farby (niekedy sú DNAPL priehľadné), nízkym koncentraciám alebo ich rôznym prejavom v horninovom prostredí. Všetky tieto faktory komplikujú charakterizáciu zdroja znečistenia, ktorú zvyčajne komplikuje prítomnosť viacerých zmesných znečisťujúcich látok.

Znečisťujúce látky ťažšie ako voda (DNAPL) sa delia do štyroch skupín:

- halogénované organické zlúčeniny,
- decht a kreozoty,
- polychlórované bifenylly (PCB),
- zmesi a pesticídy.

Väčšina lokalít znečistených DNAPL obsahuje halogénované organické zlúčeniny, najmä organochlórové. Ich široké použitie, chemické vlastnosti a vysoká toxicita sú hlavnými faktormi, ktoré problém prehľujú.

Medzi najvýznamnejšie chemické vlastnosti znečisťujúcich látok ťažších ako voda (DNAPL) patria:

- vysoká hustota;
- nízka viskozita;
- vysoká prchavosť;
- značná rozpustnosť v pomere k toxicite.

### 2.2.1 Prchavosť znečisťujúcich látok ťažších ako voda

Znečisťujúce látky ťažšie ako voda (DNAPL) možno klasifikovať aj na základe ich prchavosti. Prchavé organické zlúčeniny sa označujú ako VOC (z angl, *Volatile Organic Compounds*).

Prchavou organickou zlúčeninou je organická zlúčenina, ktorá má pri teplote 20 °C tlak pár 0,01 kPa a viac.

Prchavosť zlúčeniny je vo všeobecnosti menšia pri vyššej teplote varu ( $T_v$ ), vyššej Henryho konštante (KH) a vyššom tlaku pár (Pvap). Preto majú prchavé organické zlúčeniny (VOC) chemické zloženie, ktoré je priaznivé pre vyparovanie za normálnych podmienok prostredia, pokiaľ ide o teplotu a tlak. Vo všeobecnosti majú tieto zlúčeniny Henryho konštantu vyššiu ako  $10^{-5}$  atm m<sup>3</sup>/mol a tlak pár vyšší ako 1 mm Hg (0.0013 atm).

Z hľadiska prchavosti možno organické zlúčeniny klasifikovať na:

- prchavé (VOC);
- poloprchavé (SVOC – z angl, *Semi-Volatile Organic Compounds*);
- málo prchavé.

Vo všeobecnosti sú halogénované organické zlúčeniny prchavé alebo poloprchavé, PCB a pesticídy sú poloprchavé a mazacie oleje sú málo prchavé.

Organické zlúčeniny	Teplota varu	Príklad
prchavé (VOC)	$T_v < 250^{\circ}\text{C}$	Halogénované organické zlúčeniny, PCE a TCE
poloprchavé (SVOC)	$250^{\circ}\text{C} < T_v < 390^{\circ}\text{C}$	PCB, pesticídy, organochlórové pesticídy a iné halogénované zlúčeniny
málo prchavé	$T_v > 390^{\circ}\text{C}$	mazacie oleje

Tabuľka 2.1- Prchavosť vybraných znečisťujúcich látok

### 2.3 Oxidácia znečisťujúcich látok

In situ chemická oxidácia (ISCO) je založená na oxido-redukčnej (redoxnej) reakcii medzi oxidačným činidlom injektovaným do horninového prostredia a prítomnými znečisťujúcimi látkami. Oxidačné činidlo a ďalšie

potrebné pomocné látky sa injektujú do pôdy, kde reagujú s prítomnými znečisťujúcimi látkami. V dôsledku toho sa oxidačné činidlo redukuje a znečisťujúce látky sa oxidujú a rozkladajú na neškodné produkty, ktoré sú prirodzene prítomné v horninovom prostredí. Táto sanačná technika je vhodná len na sanáciu znečistenia organického pôvodu.

### 2.3.1 Oxidačné činidlo

Existuje niekoľko rôznych druhov oxidačných činidiel, ktoré sa používajú pri ISCO, najčastejšie sa však používajú tieto štyri oxidačné činidlá:

- manganistan (napr.  $\text{KMnO}_4$ );
- peroxid vodíka ( $\text{H}_2\text{O}_2$ ) a železo (Fe) (Fentonom riadená, alebo  $\text{H}_2\text{O}_2$  odvodená oxidácia);
- ozón ( $\text{O}_3$ );
- persíran (napr.  $\text{K}_2\text{S}_2\text{O}_8$  alebo  $\text{Na}_2\text{S}_2\text{O}_8$ ).

Oxidant	Reactive Species	Form	Persistence <sup>(1)</sup>	Stage of Development
Permanganate	$\text{MnO}_4^-$	powder/liquid	>3 months	developing
Fenton's	$\cdot\text{OH}$ , $\cdot\text{O}_2^-$ , $\cdot\text{HO}_2$ , $\text{HO}_2^-$	liquid	minutes - hours	experimental/emerging
Ozone	$\text{O}_3$ , $\cdot\text{OH}$	gas	minutes - hours	experimental/emerging
Persulfate	$\cdot\text{SO}_4^{2-}$	powder/liquid	hours - weeks	experimental/emerging

Oxidant and Reactions	Electrode Potential ( $E_h$ ) <sup>(2)</sup>
<b>Permanganate</b>	
$\text{MnO}_4^- + 4 \text{H}^+ + 3 \text{e}^- \longrightarrow \text{MnO}_2 + 2 \text{H}_2\text{O}$	1.7 V (permanganate ion) (1)
<b>Fenton's (<math>\text{H}_2\text{O}_2</math> Derived Reactants)</b>	
$\text{H}_2\text{O}_2 + 2 \text{H}^+ + 2 \text{e}^- \longrightarrow 2 \text{H}_2\text{O}$	1.8 V (hydrogen peroxide) (2)
$2 \cdot\text{OH} + 2 \text{H}^+ + 2 \text{e}^- \longrightarrow 2 \text{H}_2\text{O}$	2.8 V (hydroxyl radical) (3)
$\cdot\text{HO}_2 + 2 \text{H}^+ + 2 \text{e}^- \longrightarrow 2 \text{H}_2\text{O}$	1.7 V (perhydroxyl radical) (4)
$\cdot\text{O}_2^- + 4 \text{H}^+ + 3 \text{e}^- \longrightarrow 2 \text{H}_2\text{O}$	-2.4 V (superoxide radical) (5)
$\text{HO}_2^- + \text{H}_2\text{O} + 2 \text{e}^- \longrightarrow 3 \text{OH}^-$	-0.88 V (hydroperoxide anion) (6)
<b>Ozone</b>	
$\text{O}_3 + 2 \text{H}^+ + 2 \text{e}^- \longrightarrow \text{O}_2 + \text{H}_2\text{O}$	2.1 V (ozone) (7)
$2 \text{O}_3 + 3 \text{H}_2\text{O}_2 \longrightarrow 4 \text{O}_2 + 2 \cdot\text{OH} + 2 \text{H}_2\text{O}$	2.8 V (hydroxyl radical, see rxn 3) (8)
<b>Persulfate</b>	
$\text{S}_2\text{O}_8^{2-} + 2 \text{e}^- \longrightarrow 2 \text{SO}_4^{2-}$	2.1 V (persulfate) (9)
$\cdot\text{SO}_4^- + \text{e}^- \longrightarrow \text{SO}_4^{2-}$	2.6 V (sulfate radical) (10)

<sup>1</sup> Persistence of the oxidant varies depending on site-specific conditions. Durations specified here are based on general observations.  
<sup>2</sup> Reactive species in parentheses; reduction potential is negative.

Permanganate – hypermangán, Fenton's ( $\text{H}_2\text{O}_2$  Derived Reactant) – Fentonovo činidlo, Ozone – ozón, Persulfate – persíran

**Tabuľka 2.2- Druhy oxidačných činidiel, stabilita v prostredí, štádium vývoja a oxidačný potenciál činidiel používaných na chemickú oxidáciu in situ**

#### 2.3.1.1 Manganistan draselný ( $\text{KMnO}_4$ )

Manganistan draselný pretrváva v prostredí dlhý čas a je možná jeho difúzia v roztoku do málo priepustných materiálov a dosahuje väčšie transportné vzdialenosti cez porézne médiá.

Priama reakcia je trojelektrónová polovičná reakcia oxidácie manganistanu ( $\text{MnO}_4^-$ ) vo väčšine podmienok prostredia (pH 3,5 až 12). Jedným z vedľajších produktov reakcie je  $\text{MnO}_2$  (burel), v rozsahu pH 3,5 až 12 ide o pevnú zrazeninu.

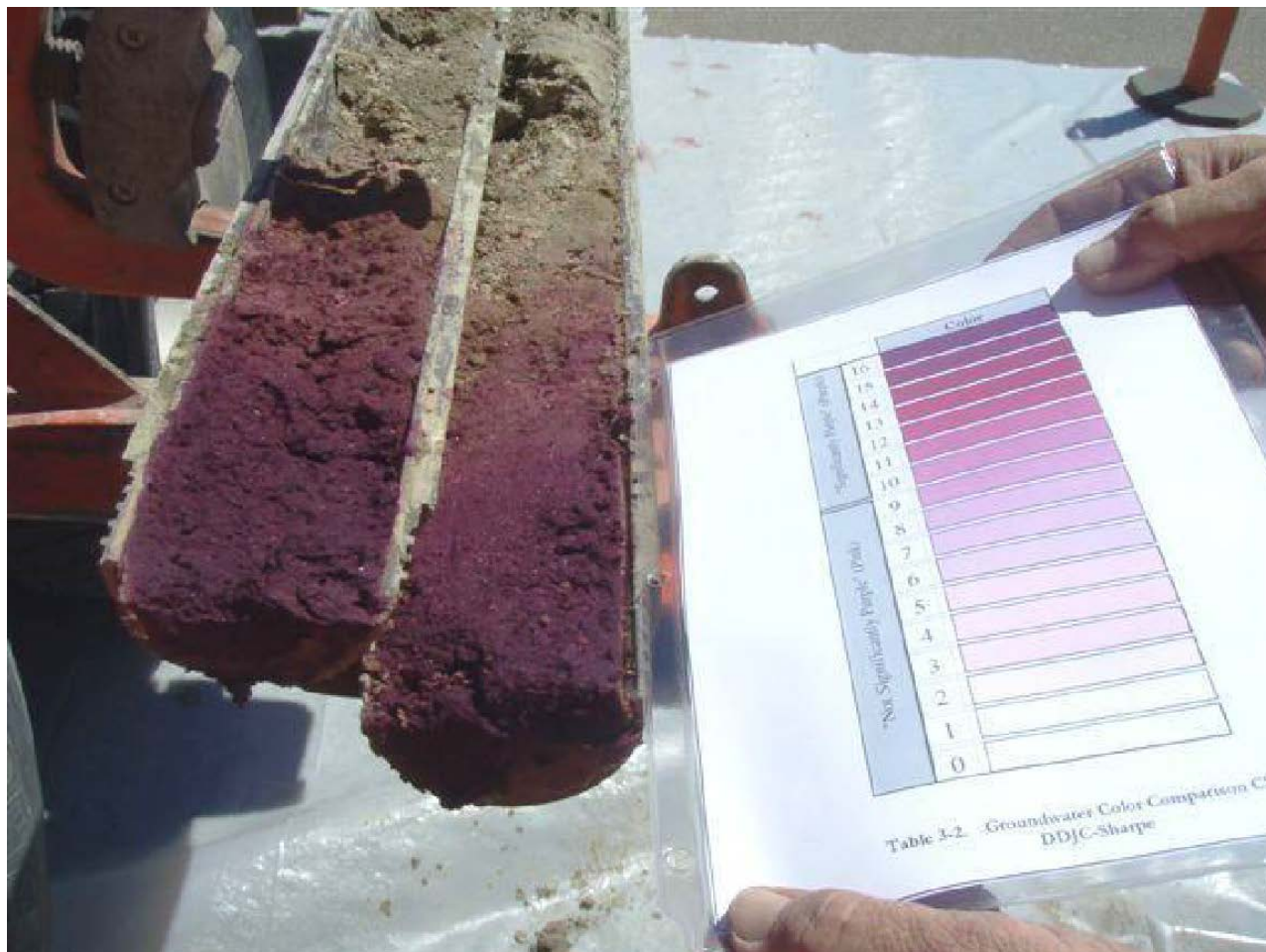
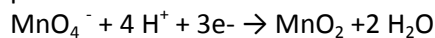

**Obrázok 2.8- Príklad postupnej difúzie oxidačného činidla manganistanu draselného (hypermangánu) vo vrtnom jadre s ílovitou horninou 90 dní po vysokotlakovj injetáži roztoku činidla (fotografia so súhlasom URS, archív Bureš)**

V kyslom prostredí (pH < 3.5) môže byť mangán v roztoku alebo v koloidnej forme prítomný v rôznych redoxne závislých oxidačných stavoch ( $\text{Mn}^{+2, +4, +7}$ ).

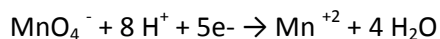

Okrem toho, v silne alkalických podmienkach, pH > 12, môže byť mangán prítomný ako  $\text{Mn}^{+6}$ .

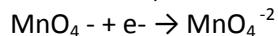

Sono riportate di seguito le reazioni di ossidazione chimica degli inquinanti: percloroetilene (PCE), triclوروetilene (TCE), dicloroetilene (DCE) e cloruro di vinile (VC).

- Tetrachlóretén, alt. perchlóretén (TECE, PCE)

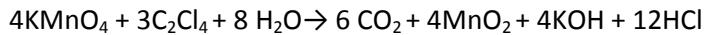

- Trichlóretén (TCE)  
 $2 \text{KMnO}_4 + \text{C}_2\text{HCl}_3 \rightarrow 2 \text{CO}_2 + 2 \text{MnO}_2 + 2 \text{KCl} + \text{HCl}$
- Dichlóretén (DCE)  
 $8 \text{KMnO}_4 + 3\text{C}_2\text{H}_2\text{Cl}_2 \rightarrow 6 \text{CO}_2 + 8 \text{MnO}_2 + 2 \text{KOH} + 6 \text{KCl} + 2\text{H}_2\text{O}$
- Vinylchlorid (VC)  
 $10 \text{KMnO}_4 + 3\text{C}_2\text{H}_3\text{Cl} \rightarrow 6 \text{CO}_2 + 10 \text{MnO}_2 + 7 \text{KOH} + 6 \text{KCl} + \text{H}_2\text{O}$

Oxid uhličitý (CO<sub>2</sub>) je vedľajším produktom oxidácie a mineralizácie organických zlúčenín a prírodných organických látok. V kolónových skúškach sa znížila priepustnosť a účinnosť preplachovania v dôsledku zrážania MnO<sub>2</sub> (zrazeniny) a z tvorby CO<sub>2</sub> (plyn).

### 2.3.1.2 Peroxid vodíka (H<sub>2</sub>O<sub>2</sub>)

Klasická Fentonova reakcia zahŕňa konkrétne reakciu medzi H<sub>2</sub>O<sub>2</sub> a železom (Fe(II)), pri ktorej vzniká hydroxylový radikál ( $\cdot\text{OH}$ ) a železité (Fe(III)) a hydroxilové ióny (OH<sup>-</sup>).

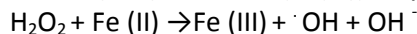

Fe(III) reaguje s H<sub>2</sub>O<sub>2</sub> alebo superoxidovým radikálom (O<sub>2</sub><sup>-</sup>)



Fe(III) reaguje so superoxidovým radikálom (O<sub>2</sub><sup>-</sup>)

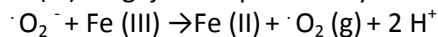

Táto všeobecná postupnosť reakcií pokračuje, až kým sa H<sub>2</sub>O<sub>2</sub> úplne nespotrebuje. Keďže H<sub>2</sub>O<sub>2</sub> je injektovaný do horninového prostredia, reaguje s mnohými inými chemickými látkami, nielen Fe(II), táto technológia sa často označuje ako katalytická oxidácia peroxidom vodíka (CHP – catalysed hydrogen peroxide)

Uvádza sa, že H<sub>2</sub>O<sub>2</sub> pretrváva v horninovom prostredí a zvodnení niekoľko minút až hodín a difúzne a advektívne vzdialenosti transportu sú relatívne obmedzené. Radikálové medziprodukty vytvorené pomocou niektorých oxidantov (H<sub>2</sub>O<sub>2</sub>, S<sub>2</sub>O<sub>8</sub>, O<sub>3</sub>), ktoré sú vo veľkej miere zodpovedné za rôzne transformácie znečisťujúcich látok, reagujú veľmi rýchlo a pretrvávajú veľmi krátky čas (< 1 sec).

### 2.3.1.3 Ozón (O<sub>3</sub>)

In-situ oxidácia O<sub>3</sub> zahŕňa injektáž zmesi vzduchu a plynného ozónu (O<sub>3</sub>) priamo do pásma prevzdušnenia a/alebo pásma nasýtenia. Aerácia (air-sparging, resp. prevzdušňovanie) je metóda, ktorá je známa a používaná a má mnoho spoločných znakov s ozónovou aeráciou – ozonizáciou (O<sub>3</sub> sparging) a môže poskytnúť teoretické a praktické východiská pre prevzdušňovanie horninového prostredia ozónom, ktoré nebolo dosiaľ dôsledne vyskúšané. Injektáž vzduchu pod hladinu podzemnej vody podporuje prchavosť, dodáva kyslík na aeróbný rozklad a môže vyvolať miešanie podzemnej vody (Johnson, 1998).



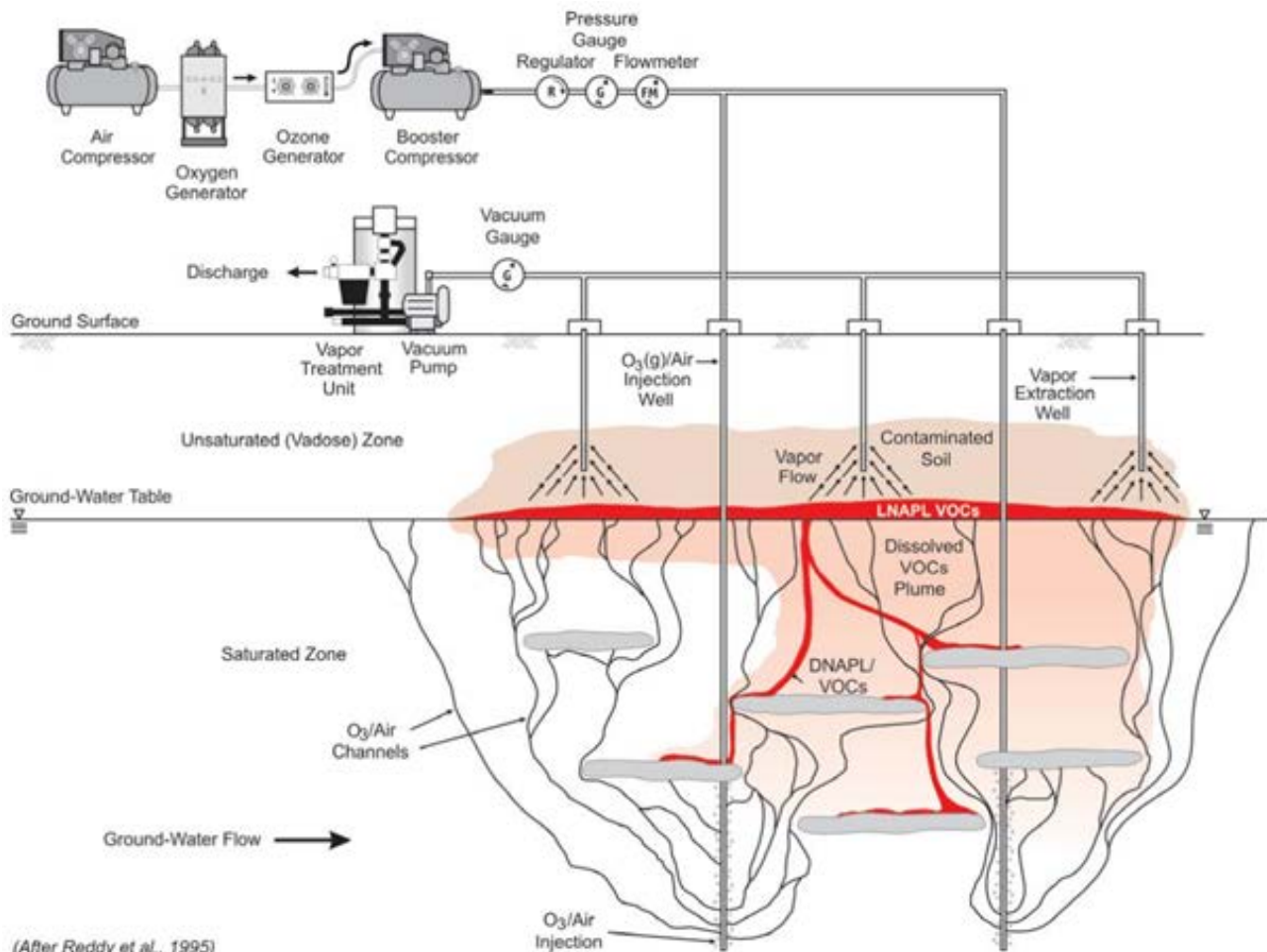

(After Reddy et al., 1995)

*Air Compressor – Oxygen Generator – Ozone Generator – Booster Compressor – Pressure Gauge – Regulator – Flowmeter – kompresor – generátor kyslíka – generátor ozónu – pomocný kompresor – tlakomer – regulátor – prietokomer; Ground Surface – povrch, Vapor Treatment Unit – čistenie emisií, Vacuum Pump – dúchadlo/výveva, Vacuum Gauge – tlakomer, Vapor flow – prúdenie plynu, Contaminated Soil – znečistená pôda/hornina, Vapor Extraction Well – extrakčný vrt, Dissolved VOCs Plume – mrak znečistenia rozpustenými prchavými uhľovodíkmi, LNAPL VOCs – voľná fáza látok ľahších ako voda / prchavé uhľovodíky, DNAPL / VOCs – voľná fáza uhľovodíkov ťažších ako voda, prchavé uhľovodíky, Ground-Water Table – hladina podzemnej vody, Unsaturated (Vadose) Zone – pásmo prevzdušnenia, Saturated Zone – pásmo nasýtenia, Ground-Water Flow – prúdenie podzemnej vody, O<sub>3</sub>/Air Channels – cesty šírenia ozónu/vzduchu, O<sub>3</sub>/Air Injection – injektáž ozónu/vzduchu*

**Obrázok 2.9- Všeobecný koncepčný model in situ ozonizácie v pásme prevzdušnenia s vákuovou extrakciou (odsávaním) pôdneho vzduchu na zachytávanie prchavých emisií a O<sub>3</sub>.**

### 2.3.1.4 Persíran sodný alebo vápenatý

Persíran je najsilnejší oxidant v rámci skupiny peroxygéňov s oxidačným potenciálom 2,12 V. Ako je znázornené nižšie, priama oxidačná polobunková reakcia pre persíran zahŕňa prenos dvoch elektrónov:

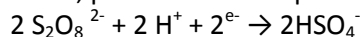

Vo väčšine prípadov si však rýchla deštrukcia znečisťujúcej látky vyžaduje aktiváciu persíranu na vznik síranových radikálov. Síranové radikály sú silné oxidačné činidlá s oxidačným potenciálom 2,6 V.

- Persíran sodný:
  - Aktivuje sa v alkalických podmienkach

- o Aktivovaný peroxidom vodíka

Aktivovaný persíran je katalyzovaný peroxidom a zásadou, ktorú poskytuje peroxid vápenatý:

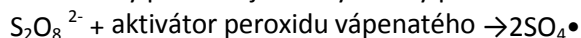

Aktivovaný persíran môže zostať k dispozícii v horninovom prostredí celé mesiace, čím poskytuje kombináciu výkonu a stability.

Použitie peroxidu vápenatého má niekoľko výhod. Prvou je, že je zdrojom alkality a peroxidu potrebných na aktiváciu persíranu. Druhou výhodou je, že po zmiešaní s vodou poskytuje dlhodobý zdroj peroxidu vodíka a hydroxidu vápenatého s pomalým uvoľňovaním.

Peroxid vodíka, ktorý sa pomaly rozkladá na kyslík a vodu, poskytuje dlhodobý zdroj kyslíka na následnú bioremediáciu ropných uhľovodíkov. Aktivácia sulfátového radikálu sa dosahuje s použitím peroxidu vápenatého pri zvýšenom pH.

Zdrojom aktivačnej energie persíranu je peroxid vápenatý, ktorý má tiež funkciu regulátora alkality (obnovuje zásadité prostredie) a pomaly uvoľňuje peroxid vodíka a hydroxid vápenatý za vzniku peroxidu vodíka. Peroxid vodíka sa rozkladá na kyslík a vodu, pričom zohráva úlohu zdroja kyslíka potrebného na rozklad (oxidáciu) uhľovodíkov.

## 2.4 In situ chemická oxidácia (ISCO) v kontexte

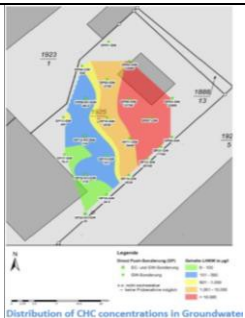
ISCO ID Krajina, organizácia, miesto	Oxidant	Znečisťujúce látky	Plocha m <sup>2</sup>	Pozorovania
Izrael. Ludan environmental technologies	KMnO <sub>4</sub>	Chlórované rozpúšťadlá, najmä trichlóretén (TCE). Iné: mangán, chróm	300	
Nemecko. RiskCom GmbH	KMnO <sub>4</sub> Na <sub>2</sub> S <sub>2</sub> O <sub>8</sub> Prídavné látky: guarán (guarový manogalaktán)	PCE/TCE do 200000 µg/l Koncentrácia VOC v zemine > 6 000 mg/kg Koncentrácia vo vzorkách podzemnej vody do 447 000 µg/l celkových chlórovaných VOC	1000 (odhad)	ISCO s použitím vysokotlakovej injektáže ako preferovaná metóda.
Nemecko. SENSATEC GMBH. Miesto neďaleko Frankfurtu nad Mohanom v Nemecku, v areáli bývalého chemického závodu, v ktorom sa vyrábali rozpúšťadlá pre kovovýrobu, čistiace chemikálie a špeciálne	Persíran draselný aktivovaný alkalickou aktiváciou pridaním peroxidu vápenatého,	Ropné uhľovodíky a BTEX v pásme nasýtenia s koncentráciou znečisťujúcich látok až do 5 000 mg/kg resp. 344 mg/kg. Podzemná voda (chlórované uhľovodíky) až 44 300 µg/l, nasledujú	620	

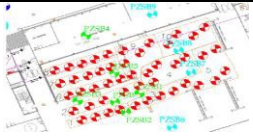
oleje.	organický polymérny viskozifikátor	ropné uhľovodíky (2 000 µg/l) a BTEX (1 800 µg/l).		Tlakovou injektážou do horninového prostredia
<b>Rakúsko.</b> Keller Grundbau Ges.mbH. Lokalita je situovaná v centre Grazu, v Štajersku.	KMnO <sub>4</sub>	Tetrachlóretén sa používal v chemickej čistiarni. Najvyššie koncentrácie 14 000 mg/m <sup>3</sup> sa zistili na mieste kde boli umiestnené práčky.	300 (odhad)	
<b>Holandsko.</b> Heijmans Infra BV V blízkosti centra mesta Uden, Holandsko.	Persíran sodný (Klozur R One) Potreba oxidantu v zemine bola odhadovaná na 3,0 g persíranu / kg zeminy	Chlórované uhľovodíky, chlórované rozpúšťadlá, najmä trichlóretén (TCE) > 16 000 µg/l v pásme prevzdušnenia. V pásme nasýtenia bolo prítomných viac ako 16000 mg/kg TCE.	270	
<b>Taliansko.</b> REGENESIS. Región Veneto, Taliansko. Na ceste v severnom Taliansku sa prevrátila cisterna s palivom a rozlialo sa viac ako 36 000 l nafty a benzínu. Palivo znečistilo kanál, protipovodňovú ochranu, zeminu a podzemnú vodu v blízkom okolí.	Perkarbonát sodný a kvapalina / gél zložené prevažne z kremičitana železa	Zemina znečistená ropnými uhľovodíkmi a BTEX. Podzemné vody znečistené MTBE a ropnými uhľovodíkmi.	cca 500	
<b>Taliansko.</b> ARPA Campania. Spoločnosť pôsobí v oblasti obrany, leteckva a bezpečnosti. V blízkosti zóny Lago Fusaro. <a href="https://www.leonardocompany.com/">https://www.leonardocompany.com/</a>	Manganistan sodný Roztok manganistanu u sodného s koncentráciou u 40 %	Zemina: Uhľovodíky: 3 500 mg/kg  Podzemná voda: benzo(a)anthracén: 7,6 µg/l pyrén: 29 µg/l benzo(b)fluorantén: 4,2 µg/l benzo(g,h,i)perylén: 2,2 µg/l PAU (sum): 10 µg/l	300 (výpočet)	

		tetrachlóretén: 50 µg/l trichlóretén: 5,4 µg/l vynychlorid: 4.1 µg /l benzén: 27 µg/l xylény: 133 µg/l toluén: 22 µg/l		
<b>Taliansko.</b> Golder Associates S.r.l. Čerpacia stanica s podzemnými nádržami na skladovanie palív, situovaná v strednom Taliansku.	Persíra n sodný (Na <sub>2</sub> S <sub>2</sub> O <sub>8</sub> ), aktivovaný pridaním hydroxidu sodného (NaOH)  Peroxid vápenatý (CaO <sub>2</sub> ), na posilnenie bioremediácie.	Zemina v pásme nasýtenia, s: benzénom 163 mg/kg etylbenzénom 502 mg/kg toluénom 648 mg/kg xylénmi 1,472 mg/kg ľahkými uhlíkovými C ≤ 12 19,509 mg/kg ťažkými uhlíkovými C > 12 5,742 mg/kg MTBE 736 mg/kg Podzemná voda, s: benzénom 46 µg/l toluénom 3,800 µg/l p-xylénom 2,619 µg/l uhlíkovými celkom (ako n-hexán) 13,000 µg/l MTBE 230 µg/l	800 (výpočet)	
<b>Taliansko.</b> Stantec Do roku 2015 bolo miesto čerpacou stanicou, od roku 2015 parkoviskom. Predpokladá sa únik pohonných hmôt z nádrží a/alebo z potrubia počas jej prevádzky.	Persíra n a peroxid vápenatý	Znečistenie MTBE bolo zistené pred likvidáciou čerpaciej stanice.	1500	
<b>Francúzsko.</b> ARTELIA Bývalá čerpacia stanica, ktorá bola demontovaná a je v štádiu ukončenia činnosti. Vplyv na zeminy a podzemnú vodu v dôsledku úniku ropných uhlíkov.	20 % manganistan sodný	Koncentrácie v zemine: Ropné uhlíkové C5-C10: 250 až 1 500 mg/kg BTEX: 80 až 820 mg/kg  Maximálne koncentrácie v podzemnej vode: Ropné uhlíkové C5-C10: 52 000 až 48 500 µg/l BTEX: 43 000 až 96 980 µg/l		

<p><b>Taliansko.</b> Arcadis Italia S.r.l. Čerpacia stanica v rovinatej oblasti severného Talianska. Činnosť spočívala v distribúcii ropných produktov a ich skladovaní v podzemných nádržiach.</p>	<p>Persíran (20 % vodný roztok) a aktivátor (peroxid vápenatý), ktorý zvyšuje pH.</p>	<p>Vo vzorkách podzemnej vody boli zistené: benzén (10 µg/l), celkové uhľovodíky (1 000 µg/l) a ETBE (1 000 µg/l)</p> <p>V zemine, pásme prevzdušnenia: ETBE (0,5 mg/kg).</p>	<p>450</p>	
<p><b>Taliansko.</b> Mares S.r.l. Situovaný na južnom brehu jazera Maggiore, v nížinnej oblasti. Čerpacia stanica, predaj ropných produktov pre motorové vozidlá, tankovanie motorových vozidiel, predaj mazív a výmena oleja.</p>	<p>Oxidačný komplex na báze persíranu sodného aktivovaný peroxidom vápenatým.</p>	<p>Ropné uhľovodíky a BTEX</p> <p>Vo vzorkách podzemnej vody zistená prítomnosť MTBE.</p>	<p>200 (odhad)</p>	
<p><b>Nemecko.</b> Züblin Umwelttechnik GmbH Priemyselná lokalita vykazovala masívne znečistenie podzemnej vody v sadrovci Keuper.</p>	<p>40 % roztok NaMnO<sub>4</sub></p>	<p>Podzemná voda vykazovala maximum chlórovaných VOC s koncentraciami od 30 do 50 mg/l</p>	<p>Celá znečistená plocha a 20 000 m<sup>2</sup>, Zdroj znečistenia 5000 m<sup>2</sup></p>	

### 3 ŠTÚDIA USKUTOČNITEĽNOSTI

Aj keď ISCO je veľmi všestranná sanačná metóda, jej aplikácia musí byť prispôsobená na každú konkrétnu lokalitu. Projektovanie udržateľnej sanácie tiež znamená, že sa musia skombinovať environmentálne, sociálne a ekonomické aspekty, aby sa dosiahlo čo najlepšie možné riešenie pre danú lokalitu. Je teda nevyhnutné porovnávať viacero realizačných scenárov, s určením optimálneho riešenia.

Na získanie potrebných údajov je potrebné vykonať nasledujúce kroky:

- Definovanie cieľov sanácie ISCO v projekte sanácie (ciele a cieľové hodnoty sanácie);
- Posúdenie uskutočniteľnosti sanácie ISCO prostredníctvom:
  - predbežného posúdenia;
  - podrobného posúdenia.

#### 3.1 Vymedzenia cieľa sanácie

Prvým krokom pri overovaní uskutočniteľnosti sanácie ISCO je definovať ciele sanácie. Definícia cieľa musí opisovať úrovne koncentrácie znečisťujúcich látok, ktoré sa majú dosiahnuť (tzv. cieľové hodnoty sanácie), a všetky obmedzujúce faktory vrátane ekonomických zdrojov a časového rámca.

Cieľ sanácie ISCO možno definovať pomocou cieľových hodnôt sanácie (MCL – z angl. Maximum Contaminant Level) alebo priemernej koncentrácie znečisťujúcich látok, ktorá sa určí ako výsledok integrovaného prístupu k sanácii na základe rôznych mechanizmov pôsobenia (fyzikálnych, chemických a biologických). Napríklad ISCO sa môže použiť po ošetrovaní horninového prostredia povrchovo aktívnymi látkami (vymývanie roztokom detergentu), alebo chemickými desorbentmi alebo sa môže použiť ako prvý krok na znižovanie koncentrácie znečisťujúcich látok, s cieľom maximalizovať účinnosť sanácie, vďaka čomu sa budú môcť následne využiť metódy bioremediácie.

Príklady cieľov pre ISCO sú:

- zníženie množstva znečisťujúcej látky v zóne sanácie (napr. o 90 %);
- dosiahnutie stanovenej koncentračnej úrovne znečistenia (cieľová hodnota sanácie) pre aplikáciu ďalších metód po skončení ISCO;
- dosiahnutie špecifikovanej úrovne znečistenia (cieľová hodnota sanácie) pre dosiahnutie súladu s legislatívnymi požiadavkami.

#### 3.2 Aplikovateľnosť sanácie ISCO

Bloková schéma na obrázku 3.1 je užitočná pre predbežné posúdenie, či je realizácia sanácie metódou ISCO uskutočniteľná a vhodná.

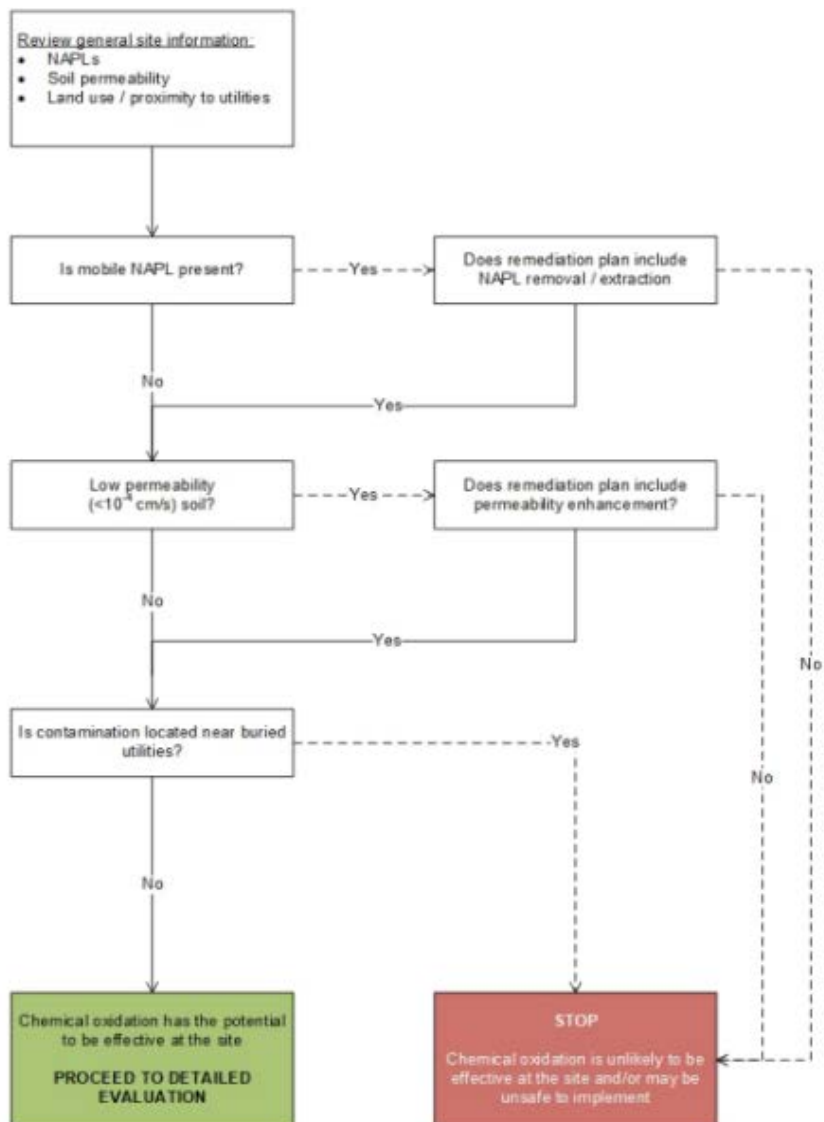

Základný prehľad o lokalite

- prítomnosť voľnej fázy
- priepustnosť
- využitie územia

Je prítomná mobilná voľná fáza (ropných) látok?

Obsahuje návrh sanácie odstránenie voľnej fázy?

Nízka priepustnosť (<math><10^{-6}</math> m/s)?

Obsahuje návrh sanácie opatrenia na zlepšenie priepustnosti?

Je znečistenie v blízkosti podzemných priestorov?

ISCO je použiteľná technika na lokalite  
**POKRAČOVAŤ PODROBNÝM HODNOTENÍM**

**STOP**  
ISCO pravdepodobne nebude účinné na lokalite a neodporúča sa jeho použitie

Obrázok 3.1- Predbežné posúdenie uskutočniteľnosti sanácie metódou ISCO, z US EPA (2004)

Predbežné posúdenie uskutočniteľnosti sanácie ISCO zahŕňa:

- spotrebu oxidačných činidiel;
- hydrogeologickú a litostratigrafickú charakteristiku;
- prítomnosť podzemnej infraštruktúry.

### 3.2.1 Spotreba oxidačných činidiel

Prítomnosť voľnej fázy ropných látok (NPAL – z angl. Non-Aqueous Phase Liquid) spôsobuje nadmernú spotrebu oxidačného činidla, čo môže ohroziť uskutočniteľnosť sanácie, pretože množstvo oxidačného činidla sa zvyšuje a počet potrebných injektáží má nepriaznivý vplyv na cenu sanácie, ako je znázornené na obrázku 3.2.

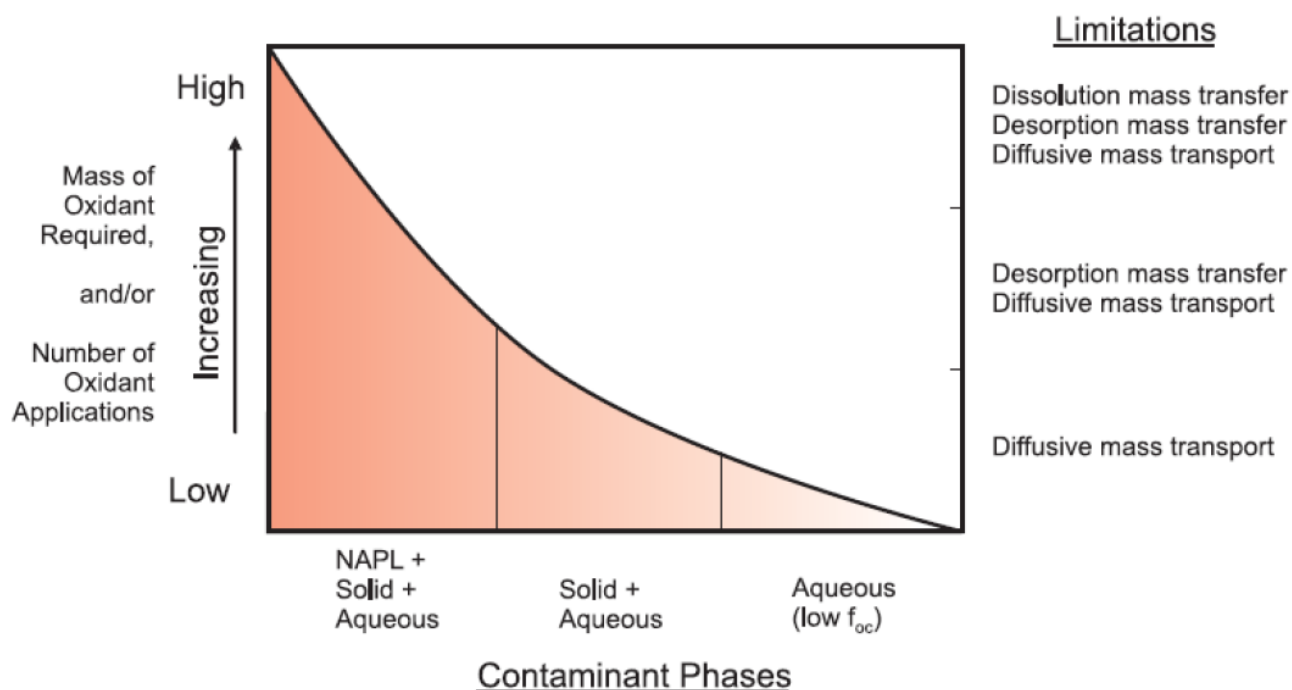

*Contaminant Phases* – fázový stav znečisťujúcej látky; *High / Increasing / Low* – Vysoký / Nárast / Nízky, *Limitations* – Obmedzenia, *Mass of Oxidant Required and/or Number of Oxidant Applications* – požaduje sa veľa oxidantu a/alebo veľa aplikačných cyklov oxidantu, *Dissolution mass transfer* – šírenie sa znečisťujúcej látky v roztoku, *Desorption mass transfer* – šírenie sa znečisťujúcej látky desorpciou, *Diffusive mass transport* – difúzne šírenie sa znečisťujúcej látky, *NAPL + / Solid + / Aqueous* – voľná fáza + / pevná fáza + / vodná, *Solid + / Aqueous* – pevná fáza + / vodná, *Aqueous (low  $f_{oc}$ )* – vodná fáza (nízky obsah organického uhlíka)

**Obrázok 3.2- Vplyv fáz znečisťujúcej látky, množstva znečisťujúcich látok a obmedzení limitov jeho zníženia vzhľadom na spotrebu oxidačného činidla a/alebo počet aplikácií oxidačného činidla potrebných na ISCO**

Schéma v tabuľke 3.1 analyzuje možné situácie distribúcie znečisťujúcich látok vzhľadom na vhodnosť a účinnosť sanácie ISCO: v prípade prvej a druhej možnosti v tabuľke (mobilná voľná fáza; spojité bazény voľnej fázy) sa musí najprv použiť iná metóda.



Spôsob distribúcie znečisťujúcej látky	Použiteľnosť ISCO?	Odporúčaný postup
Mobilná voľná (kvapalná) fáza: Spojitý bazén voľnej fázy	možná, ale náročná	Spolu s rozpúšťadlom alebo povrchovo aktívnou látkou (detergent) alebo veľmi vysoká dávka oxidačného činidla
Zvyšková voľná fáza: Nespojité kvaply voľnej fázy	áno, ale náročná	Spolu s rozpúšťadlom alebo povrchovo aktívnou látkou (detergent) alebo vysoká dávka oxidačného činidla
Vysoké koncentrácie v podzemnej vode: > 10 mg/l	áno, je vhodná	
Nízke koncentrácie v podzemnej vode: < 1 mg/l	áno, ale nemusí byť finančne výhodná	Náklady závisia od spotreby oxidačného činidla a veľkosti mraku znečistenia

**Tabuľka 3.1- Všeobecná použiteľnosť metódy ISCO (ITRC, 2005)**

Skúšky vykonané s použitím KMnO<sub>4</sub> (hypermangán) ako oxidačného činidla ukazujú, že ideálne podmienky aplikácie ISCO sú splnené pri hodnotách *SOD/TOD* (*SOD* – *Soil Oxidant Demand*, spotreba oxidantu pôdou, resp. horninou, *TOD* – *Total Oxidant Demand*, celková spotreba oxidantu pôdou, resp. horninou, podzemnou vodou a znečisťujúcou látkou) nižších ako 30 g/kg v sušine. Schémy v tabuľkách 3.2 a 3.3 sa vzťahujú na použiteľnosť ISCO v závislosti od spotreby oxidačných činidiel v pôde a horninovom prostredí a celkovej spotreby oxidačných činidiel v g/kg sušiny so zohľadnením obsahu znečisťujúcej látky a frakcie organického uhlíka v pôde a horninovom prostredí.

<i>SOD/TOD</i> (g/kg sušiny)	Použiteľnosť ISCO
< 30	uplatniteľná
> 30	na zváženie

**Tabuľka 3.2- Vzťah medzi pomerom potreby oxidantov v pôde a horninovom prostredí a celkovej potreby oxidantov a použiteľnosťou ISCO**

foc (%)	Použiteľnosť ISCO
< 0,3	uplatniteľná
0,3 < foc < 3	na zváženie
> 3	neodporúčaná

**Tabuľka 3.3- Vzťah medzi frakciou organického uhlíka (foc) v pôde a horninovom prostredí a použiteľnosťou ISCO**

### 3.2.2 Geologická a hydrogeologická charakteristika lokality

Priepustnosť a zodpovedajúca rýchlosť prúdenia podzemnej vody ovplyvňujú distribúciu oxidačného činidla vo zvodnenci, a teda aj úspešnosť sanácie ISCO (pozri tabuľku 3.4). Vysoká priepustnosť zvyčajne znamená vysokú mieru prenosu oxidačného činidla. Nízka priepustnosť znižuje oblasť vplyvu (*ROI – Radius Of Influence*), t. j. oblasť ovplyvnenú oxidantmi; v takom prípade je potrebné zahusťovať injektážnu sieť alebo používať vysokotlakú injektáž, napríklad pomocou hydrofrakovania za prítomnosti vhodných aditív.

Priepustnosť (m/s)	Použiteľnosť ISCO
> 10 – 4 m/s	vynikajúca
10 – 5 ⇔ 10 – 4 m/s	uplatniteľná
< 10 – 5 m/s	neodporúčaná

Tabuľka 3.4- Použiteľnosť ISCO v závislosti od priepustnosti

Ak je však rýchlosť príliš vysoká, je potrebné zvážiť, či je čas kontaktu medzi oxidačným činidlom a znečisťujúcou látkou dostatočný na to, aby prebehla oxidačná reakcia a uskutočnilo sa spracovanie.

Úspešnosť ISCO závisí aj od hĺbky hladiny podzemnej vody (pozri tabuľku 3.5). Optimálny rozsah pre použitie ISCO v pásme nasýtenia je v hĺbke od 3 m do 15 m. Pri hĺbke hladiny podzemnej vody menšej ako 3 m je možné odkrytie hladiny podzemnej vody; aplikácia pri hodnotách hrúbky zvodnenej vrstvy väčších ako 15 m si naopak vyžaduje zváženie z pohľadu ekonomických nákladov.

Hĺbka hladiny podzemnej vody (m p.t.)	Použiteľnosť ISCO
< 3	na prehodnotenie
3 ÷ 15	vynikajúca
> 15	na zváženie

Tabuľka 3.5- Použiteľnosť ISCO v závislosti od hĺbky hladiny podzemnej vody pod terénom

Hrúbka vrstvy podložia (m)	Použiteľnosť ISCO
< 15	uplatniteľná
> 15	na zváženie

Tabuľka 3.6- Použiteľnosť ISCO v závislosti od hrúbky vrstvy podložia

Použitie ISCO v zóne prevzdušnenia prináša ťažkosti súvisiace s rozšírením oxidačných činidiel a ich reaktivitou so zeminou

### 3.2.3 Prítomnosť infraštruktúry

Aplikovateľnosť metód sanácie in situ môže byť limitovaná prítomnosťou podzemnej infraštruktúry a/alebo podzemných inžinierskych sietí; tieto môžu byť poškodené injektážou (vŕtaním) a tiež reaktivitou produktov, ako aj ich vysokým objemom a tlakom potrebných na rozptýlenie činidiel.

Účinnosť injektáže môžu ovplyvniť aj podzemné konštrukcie, v dôsledku vytvorenia potenciálnych preferenčných ciest, ktoré by mohli odviezť oxidačné činidlo a znehodnotiť sanáciu. Prítomnosť podzemných bariér môže tiež obmedziť účinnosť zásahu z dôvodu oneskorenia alebo zabránenia kontaktu činidiel so sanovanými znečisťujúcimi látkami. V priebehu predsanačného prieskumu a spracovania štúdie uskutočniteľnosti je potrebné realizovať prieskumné práce (geofyzikálne, geoelektrické), ktoré poskytnú informácie o prítomnosti podzemnej infraštruktúry, ako podklad pre návrh sanácie.

### 3.3 Podrobné posúdenie uskutočniteľnosti sanácie

Po overení podmienok opísaných v predbežnej fáze posúdenia uskutočniteľnosti, nasleduje druhá fáza, kedy je potrebné podrobnejšie posúdenie. Musí sa vyhodnotiť vplyv ďalších faktorov, ako sú: pH, alkalita a salinita (koncentrácia chloridov). Zmeny hodnôt pH môžu ovplyvniť transport kovov a iónov v roztoku, ktoré môžu reagovať s radikálmi produkovanými oxidačným systémom, čo môže znížiť jeho účinnosť na odbúravanie znečisťujúcich látok.

Salinita (chloridy mg/l)	Použiteľnosť ISCO
< 1 000	uplatniteľná
> 1 000	na prehodnotenie

Tabuľka 3.7- Použiteľnosť metódy ISCO v závislosti od salinity

Alkalita (mg/l ako CaCO <sub>3</sub> )	Použiteľnosť ISCO
< 1 000	uplatniteľná
> 1 000	na prehodnotenie

Tabuľka 3.8- Použiteľnosť metódy ISCO v závislosti od alkality

Faktor	Podrobnosti, ktoré je potrebné zvážiť
Typ oxidačného činidla	<ul style="list-style-type: none"> <li>• Spôsobilosť primárnych znečisťujúcich látok (COCs – <i>Chemicals of Concern</i>) na ich rozklad oxidáciou</li> <li>• Spôsobilosť sprievodných znečisťujúcich látok na ich rozklad oxidáciou</li> <li>• Celková použiteľnosť oxidačných činidiel</li> <li>• Schopnosť činidla účinkovať s daným obsahom organického uhlíka na lokalite (foc)</li> </ul>
	<ul style="list-style-type: none"> <li>• Schopnosť činidla účinkovať s daným pH na lokalite</li> <li>• Schopnosť činidla účinkovať s danou úrovňou alkality na lokalite</li> <li>• Schopnosť činidla účinkovať s daným obsahom chloridov na lokalite</li> <li>• Schopnosť činidla účinkovať pri danom celkovom množstve znečisťujúcich látok (COCs) na lokalite</li> </ul>
Implementačné (injektážne) metódy	<ul style="list-style-type: none"> <li>• Prispôsobenie sa typu znečisteného média na lokalite</li> <li>• Prispôsobenie techniky injektáže typu hydraulického vodivosti lokality</li> <li>• Prispôsobenie heterogenity geologickej stavby lokality</li> <li>• Schopnosť dosiahnuť hĺbku dosahu znečistenia</li> <li>• Schopnosť odstrániť dané celkové množstvo</li> </ul>
Uvažované oxidačné činidlá a aktivátory	<ul style="list-style-type: none"> <li>• Manganistan</li> <li>• Ozón (vrátane samotného ozónu a ozónu aktivovaného peroxidom)</li> <li>• Peroxid vodíka (vrátane aktivácie železom/kyselinou, aktivácie chelátovým železom, bez aktivácie (minerálna katalýza))</li> <li>• Perkarbonát</li> <li>• Persíran (vrátane alkalickej aktivácie, tepelnej</li> </ul>
Uvažované metódy injektáže	<ul style="list-style-type: none"> <li>• Injektáž súpravou s priamym zatláčaním („direct push“)</li> <li>• Vertikálne injektážne vrty</li> <li>• Horizontálne vrty</li> <li>• Vertikálne vrty – s recirkuláciou</li> <li>• Miešanie zeminy</li> <li>• Hydraulická frakcionácia upravená pre metódu ISCO</li> </ul>

Tabuľka 3.9- Faktory sanácie ISCO, ktoré je potrebné zohľadniť

### 3.4 Reaktivita znečisťujúcich látok

Znečisťujúce látky sú z rôznych chemických skupín látok, pričom každá z nich má svoje špecifické vlastnosti, takže vykazujú rôzny stupeň náchylnosti na oxidáciu. V tabuľke 3.10 je uvedený oxidačný potenciál rôznych kontaminantov.

Vysoko oxidovateľné	Potenciálne oxidovateľné
chlóretén (vinylchlorid)	chlóroetán (etylchlorid)
chlórbenzén	chlórmetán a brómnetán
BTEX	výbušniny
polycyklické aromatické uhľovodíky (PAU)	pesticídy
fenoly	N-nitrozodimetylamín (NDMA)
MTBE	ketóny
alkohol	PCB
1-4 dioxán	dioxíny-furány

Tabuľka 3.10- Oxidačný potenciál pre rôzne znečisťujúce látky

## 4 TERÉNNA / LABORATÓRNA SKÚŠKA

Následným krokom po spracovaní štúdiu uskutočniteľnosti, ak bola ISCO vyhodnotená ako možný spôsob sanácie, je návrh technických parametrov sanácie ISCO. Ako je opísané v úvodnej kapitole, súčasťou projektovania bude séria činností, ktoré zahŕňajú vypracovanie koncepčného modelu lokality a technického návrhu sanácie (RDC – Remedial Design Characterization) a v prípade potreby aj laboratórne alebo pilotné terénne skúšky.

### 4.1 Obsah technického návrhu sanácie

Hlavné aspekty, ktoré je potrebné hodnotiť pri návrhu sanácie ISCO, sú:

- výber typu oxidačného činidla;
- množstvo oxidačného činidla;
- výber systému injektáže.;

#### 4.1.1 Výber typu oxidačného činidla

Pri výbere z možných oxidačných činidiel, ktorých reakčné účinky sú kompatibilné so znečisťujúcimi látkami, sa zohľadňujú tieto aspekty:

Účinnosť oxidačného systému v danom kontexte závisí od rôznych faktorov, ako sú: reakčná kinetika, koncentrácia oxidačného činidla, geológia, hydrogeológia, koncentrácia znečisťujúcej látky a spotreba kyslíka v podzemnej vode/zvodnenci, všeobecne označované ako spotreba oxidantu čistou zeminou a podzemnou vodou (NOD – Natural Oxidant Demand). Vhodnosť oxidačných činidiel v závislosti od týchto faktorov je opísaná v nasledujúcich častiach.

##### 4.1.1.1 Reakčná kinetika

Opisuje deštrukciu (oxidáciu) znečisťujúcej látky v priebehu času. Ak je koncentrácia oxidačného činidla oveľa vyššia ako koncentrácia oxidovanej zlúčeniny, reakcia prebieha podľa kinetiky prvého poriadku. V dôsledku toho sa rýchlosť reakcie môže merať pomocou strednej (priemernej) doby trvania reakcie.

Polčas rozkladu je čas, ktorý reakcia potrebuje na zníženie koncentrácie znečisťujúcich látok na polovicu. Doba polčasu závisí od typu použitého oxidačného činidla a od zmesi znečisťujúcich látok prítomných v podloží. Chemická oxidácia je uskutočniteľná len v prípade, že rýchlosť oxidácie znečisťujúcej látky je vyššia ako rýchlosť interakcie medzi oxidantom a spotrebou oxidantu prostredím (NOD).

Kinetiku reakcie ovplyvňujú aj procesy disperzie, desorpcie, rozpúšťania a difúzie, ktoré ovplyvňujú transport oxidačných činidiel aj transport znečisťujúcich látok v horninovom prostredí.

Chemické oxidačné činidlá sú nerozpustné vo voľnej (kvapalnej) fáze znečisťujúcich (ropných) látok (NAPL), zatiaľ čo oxidácia znečisťujúcich látok prebieha len vo vodnom roztoku. Preto musí najprv dôjsť k prenosu znečisťujúcich látok do vodného roztoku (difúzia do podzemnej vody), po ktorom nasleduje proces oxidácie. Celková rýchlosť odstraňovania znečisťujúcich látok je preto závislá na rýchlosti disperzie a difúzie voľnej fázy znečisťujúcich látok (NAPL), čo je pomalý proces v porovnaní s oxidáciou. V záujme rovnomernejšej distribúcie oxidačného činidla sa navrhuje, aby bola hustota oxidačného činidla čo najbližšie k hustote znečisťujúcej látky, aby difúzia prebiehala rovnakou rýchlosťou a cestami pre obe zlúčeniny.

### 4.1.1.2 Geológia a hydrogeológia

Transport oxidačného činidla v nasýtenej zóne je spôsobený najmä prúdením podzemnej vody, Darcyho zákonom a disperziou. Difúzia zohráva kľúčovú úlohu v prípade slabého prúdenia podzemnej vody alebo pri prísune obzvlášť koncentrovaných produktov.

Rozlišujeme tri druhy litológie hornín: s nízkou, strednou a vysokou priepustnosťou. V tabuľke 4.1 je uvedená vhodnosť oxidačných látok v závislosti od druhu priepustnosti.

Litológia	Manganistan draselný/sodný	Peroxid vodíka	Perkarbonát sodný	Persíran sodný	Ozón
Vysoko priepustné	+++	+++	+++	+++	+++
Nízko priepustné	+		-/+	+	bez údajov
Stredne priepustné	++		+	++	bez údajov

Tabuľka 4.1- Výber oxidačného činidla v závislosti od druhu priepustnosti hornín

-/+ otázne, + vhodné, ++ veľmi vhodné, +++ odporúčané

### 4.1.1.3 Spotreba kyslíka v podzemnej vode a vodonosnej vrstve (NOD)

Transportná vzdialenosť kyslíka v neznečistených častiach vodonosnej vrstvy závisí nielen od celkovej spotreby kyslíka, ale aj od nasledujúcich premenných:

- rýchlosť reakcie láto k s necieľovým i látkam i;
- rýchlosť prúdenia podzemnej vody;
- hustota roztoku.

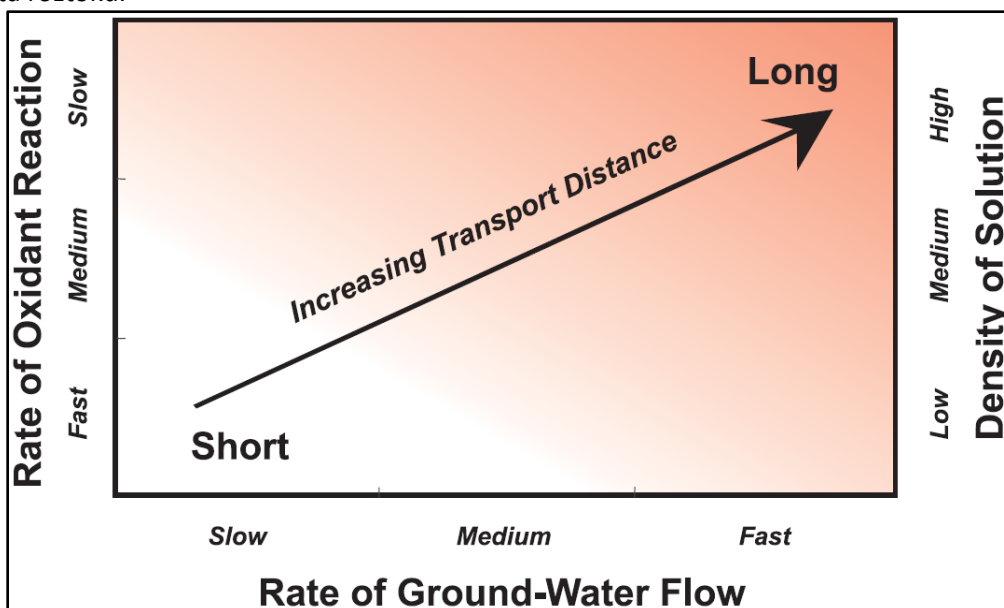

Rate of Oxidant Reaction – rýchlosť reakcie oxidantu, Rate of Ground-Water Flow – rýchlosť prúdenia podzemnej vody, Density of Solution – hustota roztoku, Fast / Medium / Slow – rýchla / stredná / pomalá, Increasing Transport Distance – nárast dĺžky transportu, Short / Long – krátka / dlhá

Obrázok 4.1- Rýchlosť reakcie oxidačného činidla/hustota roztoku ako funkcia rýchlosti prúdenia podzemnej vody

#### 4.1.1.4 pH

ISCO môže mať značný vplyv na pH zeminy, a to buď preto, že oxidant môže byť spojený s možnou produkciou protónov alebo je zdrojom hydroxylových iónov priamo počas reakcie. Rozsah účinku prítomnosti oxidantu na pH závisí od pufráciej kapacity zeminy a následne od koncentrácie uhličitanov. Koncentrácia uhličitanov preto ovplyvňuje kinetiku reakcie. V tabuľke 4.2 je uvedená vhodnosť oxidačných činidiel v závislosti od pH zeminy.

pH	Manganistan draselný/sodný	Peroxid vodíka	Perkarbonát sodný	Persíran sodný	Ozón
<5	+++	+++	--	+++	+++
5-6	+++	+++	+	+++	+++
6-7	+++	++	++	+++	+++
7-8	+++	+	+++	+++	++
8-9	+++	-	+++	+++	++
>9	++	--	+++	+++	+

Tabuľka 4.2- Výber oxidačného činidla podľa pH

-- určite nevhodné, - nevhodné, + vhodné, ++ veľmi vhodné, +++ odporúčané

#### 4.1.1.5 Frakcia organického uhlíka (foc)

Pri výbere typu oxidačného činidla je dôležité posúdiť reaktivitu sanačného roztoku s necieľovými organickými látkami (organický uhlík v horninovom prostredí), čo zvyšuje spotrebu kyslíka horninovým prostredím a pôdou (SOD – Soil Oxidant Demand). V tabuľke 4.3 je uvedená vhodnosť oxidačných činidiel v závislosti od podielu organického uhlíka (foc) v horninovom prostredí a pôde.

foc	Permanganistan draselný/sodný	Peroxid vodíka	Perkarbonát sodný	Persíran sodný	Ozón
>3%	--	--	-	+	--
1-3%	-	-	+	++	-
0,3-1%	++	++	+++	+++	++
0,1-0,3%	+++	+++	+++	+++	+++
<0,1%	+++	+++	+++	+++	+++

Tabuľka 4.3- Výber oxidačného činidla v závislosti od obsahu organického uhlíka v horninovom prostredí pôde (foc)

-- určite nevhodné, - nevhodné, + vhodné, ++ veľmi vhodné, +++ odporúčané



#### 4.1.1.6 Koncentrácia znečisťujúcej látky

Pri výbere oxidačného činidla je potrebné zohľadniť aj koncentráciu znečisťujúcej látky. V zdrojovej oblasti je potrebné použiť vysoko reaktívne oxidačné činidlá, zatiaľ čo v mraku znečistenia a na jeho okrajoch sa odporúča zvoliť menej reaktívne činidlá, aby sa maximalizoval rozsah vplyvu. Vhodnosť oxidačných činidiel je uvedená ako funkcia koncentrácie znečisťujúcej látky v tabuľke 4.4.

Koncentrácia znečisťujúcej látky	Permanganistan draselný/sodný	Peroxid vodíka	Perkarbonát sodný	Persíran sodný	Ozón
veľmi nízka					+
nízka	++	++	++	++	++
mierna	+++	+++	+++	+++	+++
vysoká	++	+++	++	+++	+
veľmi vysoká		++	+	++	-

Tabuľka 4.4 Vhodnosť oxidantov v závislosti od stupňa koncentrácie znečisťujúcej látky

- nevhodné, + vhodné, ++ veľmi vhodné, +++ odporúčané

#### 4.1.1.7 Environmentálne aspekty použitia oxidačných činidiel

Reakčná kinetika, koncentrácia oxidačného činidla, pH a teplota vodonosnej vrstvy, koncentrácia znečisťujúcej látky a spotreba oxidantu v horninovom prostredí a pôde (SOD) sú súčasťou súboru premenných, ktoré určujú „životnosť“ oxidačného činidla; to znamená dobu zotrvania oxidačného činidla po aplikácii v danom substráte. Tento aspekt má zásadný význam, pretože ovplyvňuje polomer vplyvu (ROI – Radius Of Influence), ktorý môže oxidačné činidlo dosiahnuť, kým je ešte aktívne.

Ako sa uvádza v úvodnej kapitole, ISCO je metóda, ktorá sa len zriedka používa samostatne ako jediná sanačná metóda, najmä tam, kde sú prísne legislatívne požiadavky. Bežne je potrebná kombinácia sanačných metód. To znamená, že následne sa vykonáva ďalšia sanačná metóda, ktorou by mohla byť biosanácia, či podporovaná biodegradácia.

Ekologickým a účinným prístupom na dosahovanie územia je použitie pasívnej (nereaktívnej) zlúčeniny s riadeným uvoľňovaním na stimuláciu biodegradácie in situ. Biosanácia je účinná pri mineralizácii medziproduktov vytvorených počas oxidácie, ktoré by inak zostali ako neželané pozostatky sanácie. Biosanácia môže byť poslednou nákladovo efektívnou etapou pri dosahovaní celkového cieľa sanácie podzemných vôd. Pri výbere oxidačných činidiel je preto potrebné starostlivo zvážiť len také oxidačné činidlá, ktoré nie sú agresívne voči mikroorganizmom v horninách a podzemnej vode.

V špecifických prípadoch je potrebné overiť, či vedľajšie produkty reakcie nezhoršujú hydrochemický stav podzemnej vody, najmä ak sa v nej nachádza citlivý receptor a/alebo ak sa podzemná voda využíva ako vodný zdroj. Príkladmi vznikajúcich vedľajších produktov alebo látok mobilizovaných oxidačnou reakciou sú: sírany, mangán, chróm a iné ťažké kovy.

Prítomnosť podzemných konštrukcií, potrubí alebo kanalizačných systémov môže predstavovať dôležité obmedzenie pri výbere oxidačného činidla. Injektáž veľkých objemov sanačného roztoku v blízkosti základov sa tiež neodporúča. Rovnaký záver platí aj pre použitie oxidačných činidiel, ktoré vyžadujú nízke pH v blízkosti podzemných nádrží, potrubí alebo citlivých inžinierskych sietí.

## 4.1.2 Množstvo oxidačného činidla

Na určenie množstva činidla potrebného na chemickú oxidáciu na lokalite je potrebné určiť celkovú spotrebu oxidantu (*TOD – Total Oxidant Demand*) potrebnú na sanáciu na konkrétnej lokalite. Celková spotreba oxidantu (*TOD*) zahŕňa spotrebu kyslíka na oxidáciu cieľových znečisťujúcich látok a kyslík potrebný pre “necieľové” látky akceptujúce elektróny obsiahnuté v zemine.

### 4.1.2.1 Spotreba oxidantu znečisťujúcimi látkami

Spotreba oxidačného činidla znečisťujúcimi látkami sa musí vyhodnotiť pre všetky možné fázové stavy znečisťujúcich látok:

- rozpustená fáza;
- (ab)sorbovaná fáza;
- voľná fáza;
- nevodná voľná fáza (NAPL);
- parná fáza (v pásme prevzdušnenia).

Na určenie požadovanej spotreby kyslíka sa musí v prvom rade posúdiť celkové (bilančné) množstvo každého fázového stavu znečisťujúcej látky prítomnej v horninovom prostredí. Následne sa musí odhadnúť šírka, dĺžka a hĺbka zdrojovej oblasti. Nakoniec sa v závislosti od typu zeminy (štrk, piesok, silt alebo íl) musí vykonať kvantitatívne hodnotenie objemovej hmotnosti a pórovitosti znečistenej zeminy.

Bilančné množstvo znečisťujúcej látky v roztoku (rozpustená fáza) možno vypočítať analýzou koncentrácií znečisťujúcich látok v podzemnej vode v monitorovacích vrtoch. Na druhej strane, spotrebu kyslíka súvisiacu s absorbovanou fázou možno odhadnúť buď priamo z analýzy vzoriek zemín odobratých in situ, alebo nepriamo prostredníctvom stechiometrických výpočtov. Množstvo absorbovanej fázy závisí od objemovej hmotnosti hornín vodonosnej vrstvy, frakcie organického uhlíka (*foc*) a koeficientu adsorpcie na organický uhlík (*Koc*). Objemovú hmotnosť horniny a hodnoty *foc* možno odhadnúť podľa druhu horniny, zatiaľ čo hodnotu *Koc* možno získať z literatúry alebo online databáz.

Posúdenie množstva voľnej fázy znečisťujúcich látok je často zložitý. V tejto súvislosti API a US EPA vypracovali rôzne metódy výpočtu.

### 4.1.2.2 Hmota hornín

Činidlá injektované do horninového prostredia budú samozrejme reagovať aj s organickými a anorganickými látkami prirodzene prítomnými v hmote hornín. Keďže v určitých prípadoch môže byť takto spotrebované značné množstvo kyslíka, osobitná pozornosť by sa mala aplikáciám oxidačných činidiel, ktoré sú založené na katalytických reakciách alebo pri ktorých sa ako stabilizátory alebo kondicionéry používajú iné činidlá. Príkladom tohto typu systému ISCO je katalyzovaný peroxid vodíka. Peroxid vodíka okamžite vytvorí povrchové komplexy a reaguje s kovmi, ako je železo, na minerálnych povrchoch.

### 4.1.2.3 Stanovenie spotreby oxidačných činidiel

Existujú dva prístupy k výpočtu spotreby oxidačných činidiel:

- pomocou systému založeného na celkovom obsahu organického uhlíka (*TOC – Total Organic Carbon*) a chemickej spotrebe kyslíka (*CHSK*)

- pomocou výpočtu molárneho pomeru.

Množstvo oxidačného činidla použitého na reakciu musí byť väčšie ako teoretická spotreba oxidačného činidla, aby sa zabezpečilo dostatočné množstvo reaktantu na zachovanie kinetiky prvého poriadku.

#### 4.1.3 Spôsob aplikácie sanačných roztokov

Hlavné aspekty, ktoré je potrebné zohľadniť pri návrhu injeckáže činidla, sú:

- Litostratigrafická heterogenita (rôznorodosť typov hornín), ktorá podmieňuje výber metódy a spôsobu injeckáže. Metóda priameho vtláčania (direct push) umožňuje väčšiu univerzálnosť pri distribúcii činidla priebežnou úpravou vertikálnych a horizontálnych intervalov injeckáže na základe rozdielnej priepustnosti sanovaných vrstiev hornín. Tým sa zabráni tomu, aby sa činidlo distribuovalo najmä v priepustnejších polohách; situácia, ktorá podmieňuje spätnú rekontamináciu. Horizontálny a vertikálny dosah účinku sanácie (ROI – Radius Of Influence) by sa mal projektovať v závislosti na litostratigrafickej heterogenite lokality.
- Výsledky skúšobných injeckáží počas pilotných skúšok. Odporúča sa vykonať injeckážne skúšky v rámci realizácie pilotných skúšok s cieľom získať informácie o hodnotách injeckážneho tlaku a použiteľných objemoch činidla pre každú homogénnu vrstvu.
- Výsledky stopovacích skúšok (napr. s použitím lítia a fluoresceínu), ktoré sa môžu použiť na podporu a potvrdenie výsledkov pilotnej skúšky.

#### 4.1.4 Objem injektovaného činidla

Na účinnú sanáciu sa musí do pórov horniny injektovať dostatočné množstvo oxidačného činidla, aby sa zaručila kinetika reakcie prvého rádu.

Objem oxidačného činidla, ktorý sa má vstreknúť, sa vypočíta na základe efektívnej pórovitosti objemu horniny, ktorá sa má ošetriť. V prípade heterogénnej geologickej stavby lokality sa odporúča odhadnúť hodnoty efektívnej pórovitosti pre každú jednotlivú geologickú vrstvu zvlášť, najlepšie na základe granulometrickej analýzy.

Je potrebné injektovať objem, ktorý sa rovná 10 % až 50 % efektívnej pórovitosti. Percento pórového objemu, ktoré sa musí ošetriť priamo injeckážou, závisí od navrhnutého dosahu účinkov sanácie (ROI), pretože sa očakáva, že zvyšnú časť mikropórov dosiahne činidlo prostredníctvom advekcie.

Pilotná skúška sanácie umožňuje získať podrobné informácie týkajúce sa kinetiky reakcií, ktorými sa riadi prenos hmoty (mass transfer) oxidačného činidla advekciou a desorpciou. To umožňuje odhadnúť počet potrebných injeckáží, časový interval medzi injeckážami a optimálne dávkovanie oxidačného činidla pri každej injeckáži.

#### 4.1.5 Dostupnosť oblasti sanačného zásahu

- Ak sanácia zahŕňa územie s prebiehajúcimi činnosťami alebo prístupom verejnosti (napr. cesty, areál školy, atď.), je potrebné zvážiť aj náklady spojené s dočasným uzavretím takéhoto územia.
- V tomto prípade je potrebné posúdiť, či je vzhľadom na počet potrebných injeckáží ekonomicky výhodné inštalovať trvalo vystrojené injeckážne vrty (vrty s uzatvárateľným ventilom).

#### 4.1.6 Metódy injeckáže

Najčastejšie používané metódy na injeckáž činidla do vodonosnej vrstvy sú:

- Metóda priamej injektáže – injektáž činidla do vodonosnej vrstvy sa vykonáva pomocou perforovaných dutých oceľových tyčí a pomocou špeciálnych piestových čerpadiel, ktoré umožňujú dosiahnuť vysoké tlaky (> 50 barov);
- Vrty s uzatvárateľnými ventilmi – ide o trvalo zabudované injektážne vrty, pozostávajúce z PVC zárubníc, ktoré sa hĺbia jadrovým vrtaním a tesnia a budujú betónom. Filtračná časť zárubnice je perforovaná

- otvormi, kde v jednej rovine sú 4 otvory, skupiny otvorov sú vzdialené 30 – 50 cm. Ventily sú vybavené pružnou manžetou, takže fungujú ako spätný ventil. Existujúce piezometre (hydrogeologické vrty) – injektáž sa vykonáva cez filtračnú časť piezometrov, utesnených dvoma obturátormi.

Každá z metód má svoje výhody aj nevýhody. Metóda priamej injektáže technikou „*direct push*“ umožňuje meniť polohu bodov vpichu pre každý aplikačný cyklus. To umožňuje priebežne optimalizovať či zahusťovať sieť injektážnych sond a následne zaručiť väčšiu pravdepodobnosť kontaktu oxidantu so znečisťujúcou látkou, ktorá sa má odstrániť.

Hustejšia sieť umožňuje aj zníženie injektážneho tlaku, pričom sa znižuje riziko porušenia celistvosti hornín a následnej heterogenity pri sanácii a možnosť stúpania sanačného roztoku pozdĺž injektážnej tyče. Technický limit tejto metódy, pokiaľ ide o hĺbku injektáže, je okolo 30 – 35 m (v nesúdržných horninách).

Použitie metódy priameho vstrekovania sa stáva nevýhodnou, ak je potrebných viac ako 5 až 6 injektážnych cyklov.

Metóda, ktorá potrebuje trvalo zabudované injektážne vrty má nasledujúce výhody:

- hĺbka injektáže do 100 m;
- vysoké injektážne tlaky, až do 90 barov;
- možnosť použitia veľmi viskózných zmesí;
- lepšia kontrola vertikálneho intervalu injektáže;
- nákladová efektívnosť sanácie ISCO v prípade, že je potrebný vysoký počet injektáží (> 5 – 6);
- nižší dopad na sanáciu v oblastiach s prebiehajúcimi činnosťami.

Použitie existujúcich piezometrov (hydrogeologických vrto) má ekonomickú výhodu opätovného použitia zariadení, ktorý sa už v sanovanom území nachádzajú. Vo väčšine prípadov však neumožňuje homogénne rozloženie v sanovanom území, pretože piezometre boli navrhnuté na iné účely. Ošetrovanie pomocou existujúcich piezometrov môže byť stále zahrnuté do projektu sanácie, ktorý integruje rôzne metódy injektáže, aby sa maximalizovala celková účinnosť sanačného zásahu.

Nasledujúce obrázky zobrazujú metódy injektáže s trvalo zabudovanými vrtmi s pripojovacími ventilmi a priamym vstrekaním.

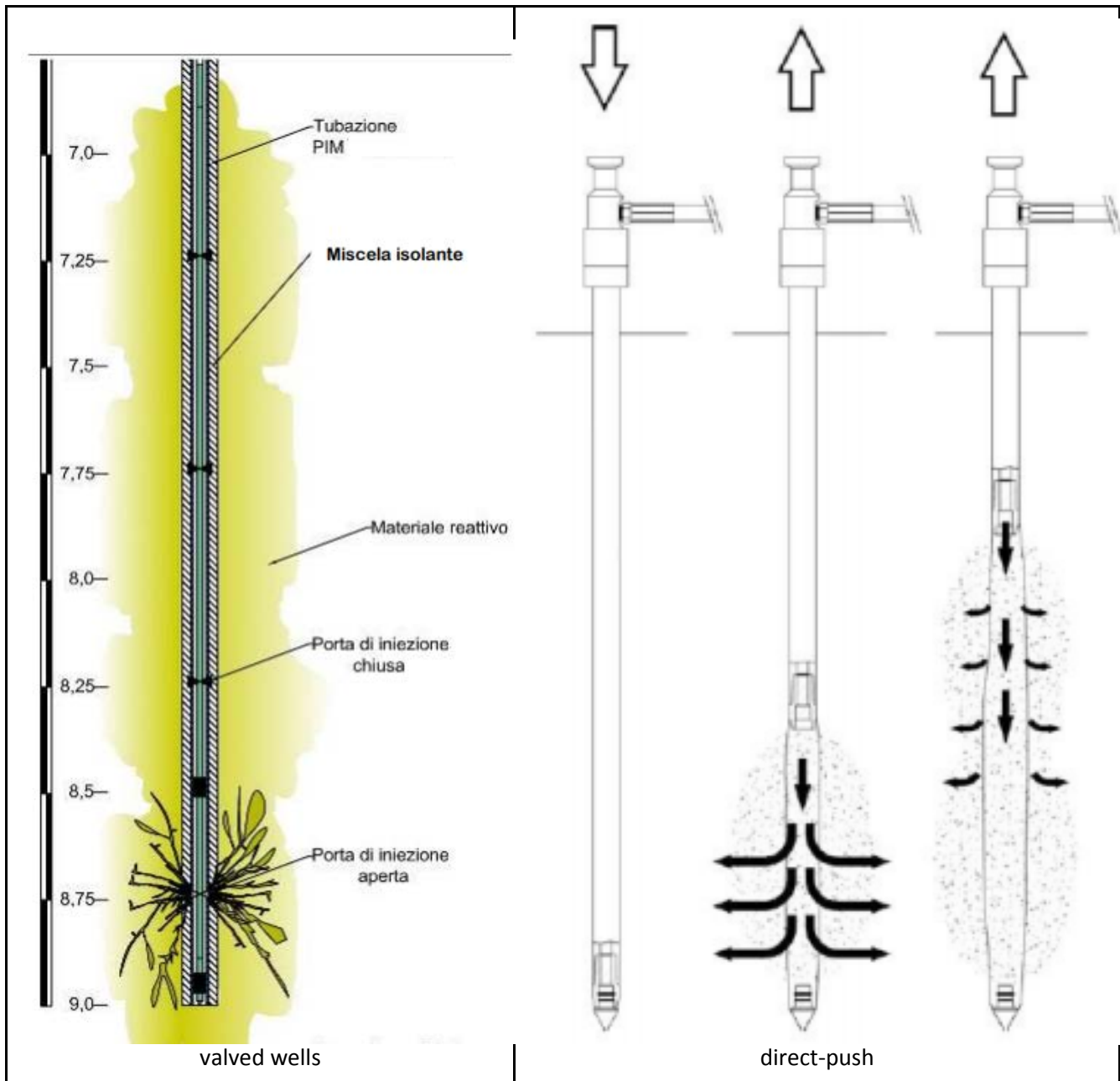

Obrázok 4.2- Trvalo zabudované vrtý s pripojovacím ventilom a metóda priameho vstrekovania technikou „direct push“ (<https://www.carsico.it/servizi/>)

Na nasledujúcich obrázkoch je opísaných niekoľko typov injektáží:

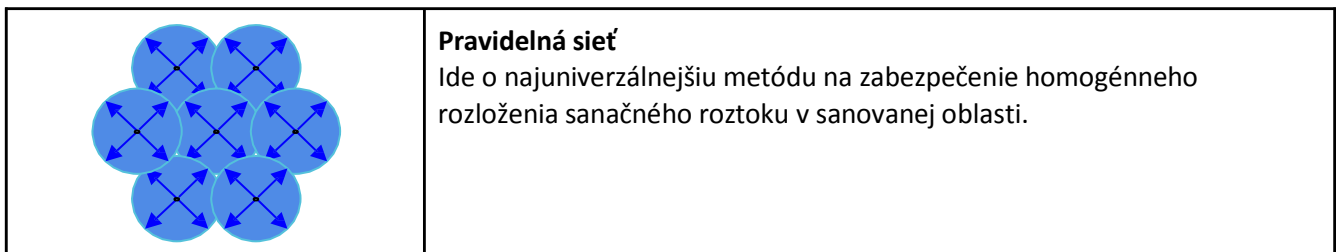

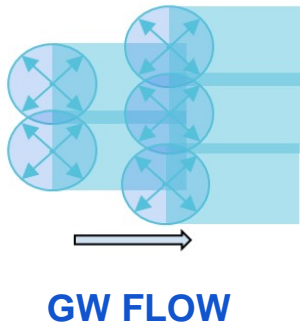

GW FLOW = smer prúdenia  
podzemnej vody

### Samovoľná infiltrácia

Tento systém využíva prúdenie podzemnej vody na šírenie sanačného roztoku advekciou (samovoľným šírením). Tento prístup možno použiť v oblastiach, kde je rýchlosť prúdenia vysoká a litológia relatívne homogénna.

Oxidačné činidlo sa aplikuje do pôdy prostredníctvom infiltračných sond bez pomoci mechanického pôsobenia alebo pod tlakom. Pri pasívnom systéme je potrebné zohľadniť infiltračnú kapacitu pôdy, hĺbku hladiny podzemnej vody, rýchlosť prúdenia podzemnej vody a životnosť oxidačného činidla. Infiltračná kapacita horninového prostredia je závislá na druhu horninového prostredia. Pri návrhu infiltračnej zostavy je dôležité čo najpresnejšie odhadnúť infiltračnú kapacitu. Hodnoty uvedené v nasledujúcej tabuľke predstavujú hrubý odpad infiltračnej kapacity. Presnejší odhad infiltračnej kapacity horninového prostredia môžu pomôcť určiť vsakovacie skúšky. Treba si uvedomiť, že nie je dôvod skúšať infiltračnú kapacitu horninového prostredia, ktorá má nízku priepustnosť. Použitie metódy samovoľnej infiltrácie si vyžaduje rýchlosť prúdenia podzemnej vody väčšiu ako 0,05 m/deň. Ak je rýchlosť prúdenia podzemnej vody menšia ako 0,05 m/deň, použitie techniky samovoľnej infiltrácie je problematické, pretože oxidačné činidlo nebude dostatočne rozptýlené v prostredí.

Samovoľnú infiltráciu je možné použiť, ak sú splnené nasledovné podmienky:

- Oxidant musí zostať v horninovom prostredí dostatočne dlho reaktívny, aby oxidoval znečisťujúce látky.
- Praktické usmernenie:
  - počas rozpadu oxidačného činidla v prostredí je dlhší ako dvojnásobok reakčného času,
  - oxidačné činidlo musí zostať v horninách dostatočne dlho stabilné, aby sa dosiahol dostatočný dosah účinnosti (ROI).

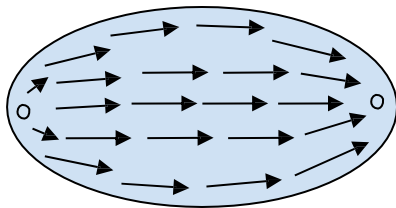



### Recirkulácia

Táto stratégia spočíva v injektáži oxidačného činidla do jedného bodu a súčasnom čerpaní podzemnej vody v inom bode.

Použitie tejto stratégie je zvyčajne obmedzené na lokality s relatívne vysokou priepustnosťou.

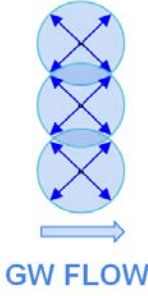
Metóda je kombináciou metódy čerpania a čistenia podzemnej vody (*Pump and Treat*) a in situ chemickej oxidácie (ISCO). Výhodou tohto postupu je vytvorenie vysokého hydraulického gradientu v znečistenom území, a teda väčšej oblasti účinku.

	<p><b>Bariérová metóda</b></p> <p>Táto stratégia spočíva v distribúcii oxidačného činidla v jednom alebo viacerých lineárnych transektoch (líniách) tak, aby znečistená podzemná voda pasívne prúdila do oblasti územia sanácie. Takéto stratégie používajú bariéru proti migrácii znečisťujúcich látok, ale nie proti prúdeniu podzemnej vody. Bariérové stratégie sú použiteľné pre systémy s kontinuálnym dávkovaním (napr. preplynovanie ozónom).</p>
	<p><b>Premiešavanie horninového materiálu</b></p> <p>Nesúdržná hornina a pôda sa premiešava s činidlom pomocou šnekového vrtáku. Metóda je vhodná len na ošetrovanie v hĺbke niekoľkých metrov.</p>

Obrázok 4.3- Typy injektážnych stratégií

parameter (koeficient filtrácie)	zabudované filtre	priame vstrekovanie	recirkulácia	samovoľná infiltrácia	premiešavanie
$> 10^{-5}$ m/sec	+++	+++	+++	+++	+++
$10^{-6} \div 10^{-3}$ m/sec	++	+++	+	++	+++
$10^{-7} \div 10^{-8}$ m/sec	-	-	--	-	+++
$< 10^{-8}$ m/sec	--	--	--	--	+++

Tabuľka 4.5- Použiteľnosť injektážnych metód v závislosti od hydraulickéj vodivosti

-- = určite nevhodná, - nevhodná, + vhodná, ++ veľmi vhodná, +++ odporúčaná

parameter (metre pod terénom)	zabudované filtre	priame vstrekovanie	recirkulácia	infiltrácia	premiešavanie
< 5 m p. t.	+++	+++	+++	+++	+++
5 ÷ 10 m p. t.	+++	+++	+++	-	+++
10 ÷ 25 m p. t.	+++	++	+++	--	-
25 ÷ 50 m p. t.	++	+	++	--	--
> 50 m p. t.	++	--	++	--	--

Tabuľka 4.6- Použiteľnosť injektážnych metód v závislosti od hĺbky sanovanej zóny

-- = určite nevhodná, - nevhodná, + vhodná, ++ veľmi vhodná, +++ odporúčaná

V publikácii Dal Santo a Prospero (2020) sú uvedené výhody a nevýhody jednotlivých spôsobov aplikácie, pozri tabuľku 4.6.



METÓDA	POUŽITEĽNOSŤ	VÝHODY	NEVÝHODY
<b>Priame vstrekovanie technikou „direct push“</b>	Pre aplikáciu všetkých typov oxidačných činidiel	<p>Dobrá distribúcia oxidantu vo vodonosnej vrstve, ak je navrhnutá s vhodnou injekčnou sieťou.</p> <p>Nemá vplyv na funkčnosť vrtov monitorovacej siete.</p>	<p>Neopakovateľné body injeckáže. Pre opakovanú injeckáž je znova potrebná vrtná súprava.</p> <p>Počas aplikácie do kolektora jemnozrnných hornín možno v niekoľkých prípadoch zaregistrovať vztlínanie činidla v prstencovom tvare okolo injeckážneho vrtu.</p>
<b>Trvalo zabudované vrtvy s ventilom</b>	Pre aplikáciu všetkých typov oxidačných činidiel	<p>Dobrá distribúcia vo vodonosnej vrstve, ak je navrhnutá s vhodnou hustotou distribučnej siete. V prípade potreby je možné opakovane vykonať ďalší cyklus injeckáže s použitím tých istých vrtov vybavených pripojovacím ventilom.</p> <p>Nemá vplyv na funkčnosť vrtov monitorovacej siete.</p> <p>Aplikácia je účinná aj do kolektorov jemnozrnných hornín bez toho, aby činidlá vystupovali na povrch.</p> <p>Injeckáž je kontrolovaná pomocou ventilov.</p>	<p>Dodatočné náklady na trvalé zabudovanie vrtov s ventilmi.</p>

Tabuľka 4.7 - Výhody a nevýhody aplikačných metód ISCO (prevzaté z Dal Santo and Proserpi, 2020)

## 4.2 Laboratórne a pilotné skúšky

Použitie laboratórnych a/alebo pilotných skúšok by sa malo zväziť na základe zložitosti a veľkosti sanovaného územia.

Investícia do nákladov na získanie informácií by mala byť vyvážená znížením neistôt, ktoré by mohli spôsobiť nedosiahnutie cieľov sanácie technikou ISCO. Postup pri laboratórnych a pilotných poľných skúškach je iteratívny

– krok sa krokom – a cieľom týchto prác je maximalizovať účinnosť a efektívnosť sanácie.

#### 4.2.1 Laboratórne skúšky

Informácie, ktoré sa získavajú z laboratórnych skúšok, sú:

- Informácie o kinetike reakcie, tvorbe medziproduktov (vrátane plynov) a produkovanom teple;
- Spotreba kyslíka pre znečisťujúce látky rozpustené alebo rozptýlené v horninovom prostredí;
- Spotreba kyslíka v neznečistenom horninovom prostredí a pôde;
- Potenciálna mobilizácia kovov;
- Pufrovacia kapacita horninového prostredia a pôdy;
- Potenciálne účinky na priepustnosť (napr. tvorba burelu –  $MnO_2$ );
- Oxidačné látky, ktoré zvyšujú účinnosť oxidačnej reakcie;
- Informácie na výpočet polomeru účinnosti (ROI – Radius Of Influence).

Laboratórne testy vo všeobecnosti nie sú reprezentatívne pre podmienky v teréne, z dôvodu problémov s rozsahom a heterogenitou hydrogeologických podmienok, reakčnou kinetikou a inými fyzikálnymi alebo chemickými vlastnosťami, ktoré nie je možné získať v laboratóriu. Napriek týmto obmedzeniam môžu výsledky laboratórnych testov poskytnúť východiskové údaje na úrovni odhadu potenciálnej účinnosti reagentu/komerčného produktu na znečisťujúce látky v území, ktoré sa má sanovať. Získané poznatky sa môžu použiť pri návrhu pilotnej terénnej skúšky. Laboratórne skúšky by mali byť navrhnuté tak, aby spĺňali vopred stanovené ciele a špecifické potreby pre projekt sanácie.

#### 4.2.2 Pilotná skúška

Pilotné skúšky sú sanáciou v malom meradle, kde sa očakáva, že rovnakým spôsobom bude následne sanované celé znečistené územie.

Súbor činností, ktoré sa majú vykonať v rámci pilotnej skúšky, je zameraný na zníženie neistoty spojenej s prítomnosťou mnohých premenných súvisiacich s heterogenitou geologickej stavby lokality, prítomnosťou stavebno-technických obmedzení a očakávaným výkonom z hľadiska zníženia znečistenia. Cieľom pilotnej skúšky je preto posúdenie:

- technickej uskutočniteľnosti ISCO;
- súladu s rozpočtovými limitmi (v rámci celkových nákladov na sanáciu);
- údajov o projekte sanácie z hľadiska technologického procesu a výkonu.

Územie realizácie pilotnej skúšky sa musí určiť s ohľadom na ciele sanácie oxidačným činidlom. Najefektívnejšie sa chemická oxidácia uplatňuje tam, kde je koncentrácia cieľových znečisťujúcich látok najvyššia, t. j. v zdrojových oblastiach. Ak sanácia zahŕňa aj elimináciu mraku znečistenia mimo zdrojovej oblasti, je potrebné naplánovať injektáž činidla tak, aby sa predišlo riziku zámeny bežnej spätnej rekontaminácie (rebound effect), od dotácie znečistenia zo zdrojovej oblasti.

Informácie, ktoré sa majú získať počas pilotnej skúšky, by mali overiť účinnosť sanácie z hľadiska uskutočniteľnosti, efektívnosti, technologického procesu a výkonu navrhovanej sanácie. Počas pilotnej fázy sa preto môže objaviť potreba prehodnotiť predchádzajúce fázy a potreba získať doplňujúce poznatky.

Získavanie informácií počas pilotnej skúšky sa v zásade týka získavania procesných údajov (výber oxidačného činidla a jeho aplikácia v cieľovej zóne sanácie) a údajov o výkonnosti (zníženie znečistenia a vedľajších účinkov). Na základe získanej spätnej väzby by sa mala overiť potreba získania nových informácií (spracovanie projektu sanácie) a/alebo opätovné posúdenie uskutočniteľnosti sanácie.

#### 4.2.3 Monitorovanie procesu sanácie

Úspešnosť sanácie in situ je výrazne podmienená správnou aplikáciou oxidačného činidla v území, ktoré sa má sanovať. Monitorovanie procesu sanácie má za cieľ kontrolovať technické parametre súvisiace s injektážou sanačných roztokov, ako aj reakcie sanovaného územia z hľadiska vyvolaných zmien fyzikálno-chemických parametrov. Ak údaje získané počas injektáže a po nej poukážu na situácie, s ktorými projekt sanácie vopred nepočítal, je potrebné opakovať vyššie opísané kroky, aby sa zabezpečila účinná a efektívna sanácia.

#### 4.2.4 Monitorovanie priebehu sanácie

hladina podzemnej vody	Neobvyklé zvýšenie hladiny podzemnej vody umožňuje overiť prítomnosť preferenčných ciest prúdenia kvapalín v kolektore.
injektážny tlak	Vyššie injektážne tlaky, ako sa očakávalo, môžu byť spôsobené nízkou priepustnosťou horninového prostredia. Zvýšenie tlaku na prekonanie odporu prostredia môže spôsobiť nekontrolovanú distribúciu činidla v dôsledku rozpukania hornín. Preto je potrebné získať ďalšie poznatky. Injektážne tlaky nižšie ako predpokladané, prípadne spojené so zvýšením prietoku, môžu byť spôsobené prítomnosťou preferenčných ciest (napr. štrkové lôžka inžinierskych sietí, kanalizácia).
fyzikálno-chemické parametre	Neočakávané hodnoty vodivosti, teploty, pH, redox potenciálu a rozpusteného kyslíka naznačujú prítomnosť preferenčných ciest alebo nedostatočného dosahu účinnosti (ROI).

Tabuľka 4.8- Zhrnutie najdôležitejších parametrov sanácie ISCO

##### 4.2.4.1 Indikátory priebehu sanácie

Na meranie postupného znižovania znečistenia možno určiť rôzne typy ukazovateľov výkonnosti (indikátorov!), a to napr.:

- Koncentrácia znečisťujúcej látky – ukazovateľ používaný na porovnanie s legislatívnymi limitmi (MCL – Maximum Concentration Limit), cieľovými hodnotami sanácie alebo na vyhodnotenie prechodu na iné technológie (napr. bioremediácia, podporovaná atenuácia – MNA – Monitored Natural Attenuation). Koncentráciu možno hodnotiť priestorovo, pomocou máp izolínií koncentrácií a časovo, výpočtom trendu pomocou štatistických testov (napr. trendovou analýzou);
- miera úbytku hmoty – ukazovateľ používaný na preukázanie stupňa účinnosti sanácie. Vyhodnotenie úbytku hmoty možno získať bilančným výpočtom celkových množstiev. Na dostatočne presný výpočet

bilančných množstiev (vrátane voľnej fázy) sa musia odobrať aj vzorky horniny z pásma nasýtenia (saturovanej zóny). Iný, menej presný spôsob, ktorý podhodnocuje skutočné úbytky hmoty, je založený na zmene koncentrácií rozpustených znečisťujúcich látok.

- Hmotnostný tok – ukazovateľ používaný na preukázanie pretrvávania znečisťujúcej látky v zdrojovej oblasti.

#### 4.2.4.2 Monitorovacia sieť

Miesta monitorovania priebehu sanácie musia byť navrhnuté tak, aby bolo možné merať účinnosť sanácie, a teda aj dosiahnutie cieľov sanácie ISCO. Rozlišujeme nasledovné plochy sanácie:

- plocha sanačného zásahu – plocha ovplyvnená sanáciou definovaná miestom injektáže a dosahom jej účinku (ROI – Radius Of Influence);
- prechodná plocha – plocha ovplyvnená geochemickými účinkami spôsobenými oxidačným činidlom;
- mrak znečistenia – plocha mraku znečistenia so zvyškovým znečistením v podzemnej vode;

Miesta, kde bola vykonaná injektáž, sa môžu použiť na účely monitorovania, len v niektorých prípadoch, pretože by mohli poskytnúť nereálne informácie.

Monitorovacie miesta v zdrojovej oblasti sa používajú na kontrolu dosahu účinkov sanácie (ROI).

Počet piezometrov (hydrogeologických vrtov s hladinou podzemnej vody) závisí od cieľov sanácie:

- na overenie zníženia množstva znečisťujúcich látok v zdrojovej oblasti postačujú piezometre v sanovanej oblasti;
- na posúdenie súladu s legislatívnymi limitmi (MCL) a cieľovými hodnotami sanácie je potrebné zabezpečiť monitorovacie body na hranici pozemku v smere prúdenia podzemnej vody;

na posúdenie pretrvávania vedľajších účinkov sanácie spôsobených injektážou sanačných roztokov z hľadiska účinkov na koncentráciu vedľajších produktov v podzemnej vode (napr. sírany, Mn) a/alebo mobilizácie iných znečisťujúcich látok (napr. toxické kovy) je potrebné zabezpečiť monitorovacie body v prechodnej oblasti.

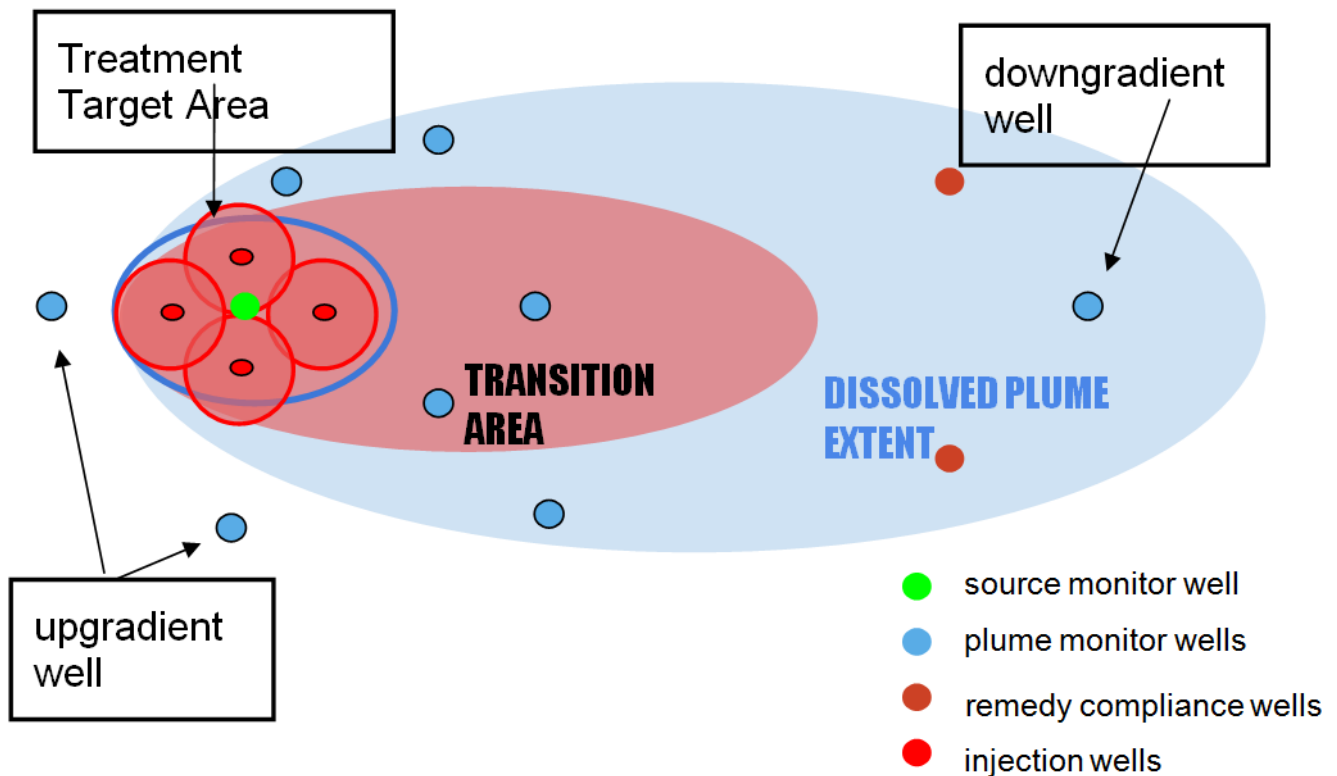

*Treatment Target Area* – cieľová oblasť sanácie, *upgradient well* – vrt nad cieľovou oblasťou, z hľadiska smeru prúdenia podzemnej vody, *downgradient well* – vrt pod cieľovou oblasťou z hľadiska smeru prúdenia podzemnej vody, *TRANSITION AREA* – prechodná oblasť, *DISSOLVED PLUME EXTENT* – mrak znečistenia so zbytkovou znečisťujúcou látkou v podzemnej vode, *source monitor well* – monitorovací vrt na zdroji, *plume monitor wells* – monitorovacie vrty v mraku znečistenia, *remedy compliance wells* – monitorovacie vrty na hranici pozemku, *injection wells* – injekčné vrty

**Obrázok 4.4- Rozmiestnenie monitorovacích vrtov**

#### 4.2.4.3 Frekvencia monitorovania

Frekvencia monitorovania musí umožniť pochopenie vývoja účinkov sanácie. V počiatočných fázach sanácie musí byť frekvencia veľmi vysoká, zatiaľ čo v nasledujúcich obdobiach sa môže znížiť na základe priebežného vyhodnotenia získaných údajov.

Typické parametre, ktoré je potrebné monitorovať na účely hodnotenia účinnosti sanácie, sú:

- Parametre, ktoré umožňujú posúdiť životnosť činidla, napr. pH, oxidačno-redukčný potenciál (ORP), rozpustený kyslík;
- fenomén spätnej rekontaminácie (rebound effect) – súvisí s mechanizmami fázového prenosu (desorpcia a rozpúšťanie) znečisťujúcej látky;
- polčas rozpadu koncentrácie znečisťujúcej látky – súvisí s reakčnou kinetikou.

Niektoré kritériá na plánovanie frekvencie monitorovania sú:

- rýchlosť prúdenia podzemnej vody;
- reakčná kinetika oxidačného produktu.

## 5 MONITOROVANIE

### 5.1 Typy skúšok

Pred výberom a použitím oxidačného činidla pre ISCO je potrebné podrobne poznať hydrogeologické podmienky lokality a geochémiu horninového prostredia, aby bolo možné rozhodnúť o type, spôsobe a množstve použitého činidla. Keďže tieto podmienky môžu byť veľmi rozdielne, monitorovanie je nevyhnutné pre návrh úspešnej sanácie ISCO. Pred vlastnou realizáciou sanácie sa preto odporúča vykonať:

- Laboratórne skúšky. Účelom týchto skúšok je vyhodnotiť účinnosť konkrétneho typu činidla na vzorke horniny z lokality a vypočítať jeho spotrebu.
- Stopovacie skúšky. Účelom týchto skúšok je vylúčiť existenciu nežiadúcich preferenčných ciest, ktorými by mohlo činidlo unikať. Preto sa pri týchto testoch musí zadefinovať skutočný smer a rýchlosť prúdenia podzemnej vody a transportu znečisťujúcich látok a činidiel. Na tento účel možno použiť niektoré typy fluoresceínu, LiCl, atď. Výsledky stopovacej skúšky musia poskytnúť údaje potrebné na špecifikáciu systému sanácie, ktorý bude pozostávať z infiltrácie činidiel ISCO v rámci jej aplikačných cyklov a prípadne z aplikácie podporných roztokov PAL (aniónové detergenty). Niekedy možno manipulovať s požadovaným smerom pohybu infiltrovaného činidla čerpaním vybraných vrtov a vsakovaním na druhej strane. Po začatí skúšky sa vzorky odoberajú v časovom intervale zodpovedajúcom hydrogeologickým podmienkam, napr. jeden krát denne počas 5 dní v piesčitej hornine, ale podstatne dlhšie v horninách s nižšou priepustnosťou..
- Poloprevádzkové skúšky na mieste. Účelom týchto skúšok je vyhodnotiť ISCO v priebehu skúšobnej prevádzky. Skúšky sa vykonávajú na vybranom vrte približne mesiac. Na základe získaných výsledkov je možné upraviť dávkovanie oxidačných činidiel, detergentov a parametrov, ako je množstvo oxidačného činidla, spôsob a frekvencia dávkovania.

ISCO sa často odporúča kombinovať s inými sanačnými metódami in situ v pásme nasýtenia pomocou hydraulických sanačných metód a podporného vymývania s povrchovo aktívnymi látkami (PAL). Aplikácia PAL je určená na mobilizáciu voľnej fázy, zatiaľ čo použitie ISCO je situované mimo zdrojových oblastí do okrajových častí v smere prúdenia podzemnej vody na vyčistenie rozpusteného znečistenia. Infiltrácia sa môže vykonávať prostredníctvom vertikálnych vrtov, horizontálnych vrtov, reaktívnych stien a injektážnych sond.

Výber situovania monitorovacích vrtov musí byť v súlade s polohou infiltračných vrtov a ohnisk znečistenia – na vstupe podzemnej vody do územia (referenčné vrty) a na výstupe z územia (monitorovacie vrty), ako aj s polohou čerpaných objektov a vrtov v mraku znečistenia.

Na bilancovanie množstva znečisťujúcich látok v horninovom prostredí a ich degradačných produktov možno použiť rôzne metódy:

- Bilancia degradačných produktov znečisťujúcej látky z úbytku celkového množstva znečisťujúcej látky na lokalite. V prípade in situ sanačných metód môže nastať úbytok koncentrácie znečisťujúcej látky na úkor jej degradačných produktov. V prípade in situ degradácie chlórovaných uhľovodíkov možno bilanciu degradačných produktov znečisťujúcej látky určiť za vhodných podmienok na základe zmien koncentrácie chloridov. Použitie chloridov sa však pomerne často vylučuje z dôvodu ich vysokých vedľajších koncentrácií v podzemnej vode.
- Bilancia degradačných produktov znečisťujúcej látky na základe množstva spotrebovaných podporných látok. Bilancia degradačných produktov znečisťujúcej látky na základe zmeny koncentrácie produktov degradácie.

- Bilancia degradačných produktov znečisťujúcej látky na základe zmeny pomeru izotopov C12/13 a C13/12. Ide o najnovší a pravdepodobne najpresnejší spôsob bilancovania rozložených organických látok in situ. Metóda je založená na sledovaní zmien izotopového zloženia C12/13 v dôsledku rozkladu znečisťujúcich látok na báze uhlíka (hydrouhličitanov) in situ. V poslednom čase sa začal používať aj izotopový pomer C13/12. Ide pravdepodobne o najslubnejší spôsob vykonávania in situ bilancie degradovaných organických uhlíkovodíkov.

## 5.2 Typy monitorovania

### 5.2.1 Prevádzkovo-technologické monitorovanie

Účelom je monitorovanie koncentrácie oxidačného činidla a jeho pohybu v kolektore a monitorovanie funkčnosti zariadení.

Počas sanácie sa monitorujú koncentrácie znečisťujúcich látok a číndiel na lokalite v dostupných monitorovacích vrtoch a priebežne sa vyhodnocuje, či sanácia prebieha správne. Výsledky sa pravidelne vyhodnocujú v ročných správach spolu s odporúčaniami.

### 5.2.2 Priebežné a záverečné monitorovanie

Účelom je vyhodnotiť, či boli úspešne splnené ciele sanácie.

Dosiahnutie cieľových hodnôt sanácie je možné preukázať až v okamihu vymiznutia podpornej látky (čínidla) a účinkov vyplývajúcich z jej prítomnosti v podzemí (nereagujúce/nezreagované čínidlo).

Existuje niekoľko základných prístupov, ktoré možno použiť na hodnotenie dosiahnutia cieľových parametrov sanácie:

- Cieľová hodnota sanácie je dosiahnutá, keď koncentrácie na všetkých objektoch sanácie a monitorovania v záujmovom území neprekračujú cieľové hodnoty sanácie. Tento prístup predstavuje nulovú toleranciu prekročenia cieľových hodnôt sanácie a vedie k optimálnym výsledkom sanácie. Môže však viesť k nadmerným nákladom na sanáciu, najmä v prípade komplikovaných prírodných podmienok, keď nie je možné presne definovať rozsah a mieru znečistenia v horninovom prostredí alebo nedosiahnuteľnosť cieľov za prijateľných technických a ekonomických podmienok.
- Cieľová hodnota sanácie sa dosiahne vtedy, keď koncentrácie na väčšine objektov sanácie a/alebo monitorovania v záujmovom území neprekročia cieľové hodnoty sanácie. Napríklad 20 % prekračuje stanovenú neprekonateľnú hodnotu podľa typu znečisťujúcej látky. Táto metóda predstavuje štatistický prístup pripúšťajúci do určitej miery toleranciu prekročenia cieľových hodnôt sanácie. V tomto prípade sa monitorovacie body považujú za orientačné a mali by byť reprezentatívne rozmiestnené po celom záujmovom území tak, aby bolo možné objektívne posúdiť dosiahnutie cieľových hodnôt sanácie, najmä vo vzťahu k pôvodnému rozsahu mraku znečistenia. Výsledky monitorovania sa potom štatisticky spracujú a interpretujú. Body reprezentujúce miesta s extrémnymi hodnotami a body reprezentujúce väčšinu sanovaného územia sa spracúvajú odlišne.
- Cieľový sanačný parameter sa dosiahne po odstránení/stabilizácii určitej časti znečisťujúcej látky. Tento prístup predpokladá hodnotenie na základe bilančného hodnotenia množstva znečisťujúcej látky pred a po ukončení sanácie
- Cieľový parameter sa dosiahne vtedy, keď sa riziko zo znečistenia životného prostredia zníži na najnižšiu prijateľnú úroveň, pričom sa vykoná technicky a ekonomicky prijateľný a odôvodnený sanačný zásah.

Tento prístup umožňuje ukončiť sanáciu vtedy, keď zvyškové znečistenie nepredstavuje zvýšené riziko pre životné prostredie a zároveň by si jej úplné odstránenie vyžadovalo technicky a ekonomicky neúnosný zásah.

Ak sa dosiahnu cieľové hodnoty sanácie, mali by sa pridať ďalšie kroky monitorovania.

### 5.2.3 Posanačné monitorovanie

Cieľom je preukázať udržateľnosť dosiahnutých cieľových hodnôt sanácie. V tomto prípade je to úloha tiež čisto špecifická pre pomery záujmového územia. Udržateľnosť dosiahnutých cieľových hodnôt sanácie je možné preukázať len dlhodobým monitorovaním vhodne zvolených monitorovacích bodov. Vo väčšine lokalít možno po ukončení aktívneho zásahu očakávať následné zvýšenie koncentrácií sledovaných znečisťujúcich látok (rebound effect).

Bežne sledovanými ukazovateľmi sú pH, teplota a vodivosť podzemnej vody, použité činidlo, znečisťujúca látka a v neposlednom rade sekundárne produkty rozkladu. Odber vzoriek sa musí vykonávať dynamickým začerpaním. Niektoré znečisťujúce látky, napríklad chlórované uhľovodíky, sa rozkladajú na degradačné produkty (perchlór – vinylchlorid), ktoré sú toxickejšie ako pôvodná znečisťujúca látka. Tieto toxické produkty rozpadu sa stále môžu nachádzať na lokalite.

Doba monitorovania musí byť dostatočne dlhá, často 3 až 5 rokov, a závisí od hydrogeologických podmienok, veľkosti lokality a prípadne množstva znečisťujúcej látky v horninovom prostredí. Časový rámec monitorovania by mal zahŕňať aj možnosť spätnej rekontaminácie (rebound effect), t. j. nárastu koncentrácií znečisťujúcich látok po tom, ako sa sanácia považovala za ukončenú. Oxidačné činidlo spravidla reaguje s rozpustenou frakciou znečisťujúcich látok v podzemnej vode. Zdroje sekundárneho znečistenia sú prítomné na dne kolektora vo forme voľnej fázy znečisťujúcej látky ťažšej ako voda (DNAPL) alebo v pásme prevzdušnenia, odkiaľ sa do kolektora dostávajú vyplavovaním prostredníctvom dažďových zrážok alebo sa dokonca nachádza mimo lokality, a po určitom čase môže opäť dochádzať k zvýšeniu koncentrácií vo vysanovanom území. Najväčšie zvýšenie koncentrácií môže nastať tam, kde sa sanáciou znečistenie odstránilo len čiastočne a kde v horninovom prostredí ostáva voľná fáza znečisťujúcej látky. Z hydrogeologického hľadiska by obdobie posanačného monitorovania malo závisieť od rýchlosti prúdenia a migrácie znečistenia tak, aby sa v prvých rokoch po ukončení sanácie monitorovala celá oblasť pôvodného mraku znečistenia a jeho okolia.

### 5.2.4 Spracovanie aktualizovanej analýzy rizika po ukončení sanácie

Po záverečnej správe zo sanácie a správe z monitorovania po ukončení sanácie sa môže vypracovať aktualizovaná analýza rizika, ktorá sa vypracuje na základe priebežného, záverečného a následného monitorovania po ukončení sanácie. Pri spracovaní aktualizovanej analýzy rizika sa nepredpokladajú žiadne ďalšie práce technického charakteru. V aktualizovanej analýze rizika sa posúdia riziká vyplývajúce zo zostatkového znečistenia na lokalite.

Použitie oxidačných metód in situ môže byť spojené s určitými technickými problémami. Je napríklad potrebné skontrolovať prítomnosť prioritných ciest šírenia čínidiel – napr. netesných podzemných inžinierskych sietí uložených pod hladinou podzemnej vody, ktoré môžu odvádzať podzemnú vodu a odvádzať aplikované roztoky čínidiel mimo sanovanú oblasť. Únik zvyškov čínidla do čistiarne odpadových vôd a následne do povrchových vôd môže spôsobiť problémy, ako aj znečistenie okolitých vrtov čínidlom.



## 6 ZÁVER

ISCO zahŕňa skupinu sanačných techník v neustálom vývoji, zahŕňajúcom množstvo oxidačných činidiel, často zahŕňajúcich komplexnú chémiu. ISCO možno považovať za agresívny sanačný prístup. Často sa vyberá ako sanačná metóda, keď je kľúčovým kritériom obmedzený čas sanácie. Na zvýšenie účinnosti a udržateľnosti sanácie sa však ISCO musí hodnotiť ako súčasť integrovaného prístupu, ktorý pozostáva zo sledu viacerých sanačných metód. Chemická oxidácia je intervenčná metóda, ktorá sa používa najmä v pásme nasýtenia (kolektor podzemnej vody) a v zdrojových oblastiach, zatiaľ čo použiteľnosť vo vrchnejšej vrste horninového prostredia a pôdy, v pásme prevzdušnenia a tiež v pásme nasýtenia mimo zdrojovej oblasti sa musí starostlivo posúdiť.

Posúdenie uskutočniteľnosti sanácie ISCO sa musí v každom prípade vykonať s ohľadom na stanovené ciele sanácie bez ohľadu na to, či je zahrnuté do sanácie pozostávajúcej z kombinácie viacerých metód, alebo či sa ISCO plánuje použiť samostatne. Spôsob výskytu znečisťujúcej látky v horninovom prostredí môže poskytnúť prvý orientačný bod pri posudzovaní uskutočniteľnosti, ale s cieľom zvýšiť pravdepodobnosť úspechu a účinnosti sanácie chemickou oxidáciou je potrebné zohľadniť ešte tieto kľúčové faktory:

- Presné modelovanie hydrogeologických charakteristík s cieľom zabezpečiť účinnú distribúciu oxidačných činidiel a vypočítať polomer účinku v závislosti od heterogenity sanovanej oblasti;
- Primeraná geochemická charakteristika na výpočet spotreby kyslíka necieľovými látkami pri sanácii (prirodzená spotreba kyslíka);
- 3D charakteristika znečistenia spojená s litostratigrafickými charakteristikami s cieľom overiť oblasti akumulácie znečisťujúcich látok a oblasti rozptylu znečisťujúcich látok.
- Vyhodnotenie viacerých alternatív sanácie v preprojektovej fáze, urobené na základe integrovaného prístupu, s cieľom určiť postupnosť metód, ktoré maximalizujú účinnosť počas celého procesu sanácie;
- Vykonanie laboratórnych a/alebo terénnych skúšok na zníženie neistoty v predsanačnej fáze prípravy;
- Vykonanie monitorovania v plnom rozsahu na overenie splnenia cieľov sanácie.

## POUŽITÁ LITERATÚRA

*Dokumenty sú uvádzané v abecednom poradí nasledovne: [Autor/Autori, Rok, Názov, #]*

- Agència de Residuos de Catalunya, 2014, Guía técnica para la evaluación de la problemática del subsuelo asociada a los compuestos organoclorados  
[http://residus.gencat.cat/web/.content/home/lagencia/publicacions/sols\\_contaminats/guia-tecnica-compuestos-organoclorados-ARC.pdf](http://residus.gencat.cat/web/.content/home/lagencia/publicacions/sols_contaminats/guia-tecnica-compuestos-organoclorados-ARC.pdf)
- Compuestos orgánicos tóxicos,  
[https://www.ugr.es/~fgarciac/pdf\\_color/tema11%20%5BModo%20de%20compatibilidad%5D.pdf](https://www.ugr.es/~fgarciac/pdf_color/tema11%20%5BModo%20de%20compatibilidad%5D.pdf)
- CRC CARE, 2018, Technology guide: In-situ chemical oxidation, consulted at  
[https://www.crccare.com/files/dmfile/ITechguide\\_ISCO\\_Rev0.pdf](https://www.crccare.com/files/dmfile/ITechguide_ISCO_Rev0.pdf)
- Dal Santo, M., & Prosperi, G. (2020). Application of chemical reagents as innovative remediation technologies for groundwater impacted by petroleum hydrocarbons in Italy. *Acque Sotterranee - Italian Journal of Groundwater*, 9(1). <https://doi.org/10.7343/as-2020-419>
- Discovered life project 2021, <http://en.lifediscovered.es/>
- FAO 1998, Obsolete pesticides brochure <http://www.fao.org/NEWS/1998/img/pestbroc.pdf>
- Scott G. Huling, Bruce E. Pivetz, 2006, In-Situ Chemical Oxidation
- ITRC 2005, Technical and Regulatory Guidance for In Situ Chemical Oxidation of Contaminated Soil and Groundwater, consulted at <https://www.itrcweb.org/Guidance/>
- ITRC, 2020, Optimizing Injection Strategies and in situ Remediation Performance. OIS-ISRP-1. Washington, D.C.: Interstate Technology & Regulatory Council, OIS-ISRP Team. consulted at <https://ois-isrp-1.itrcweb.org/3-amendment-dose-and-delivery-design/>
- Keita Nakamura, Mamoru Kikumoto, 2014, Modelling water–NAPL–air three-phase capillary behaviour in soils <https://doi.org/10.1016/j.sandf.2014.11.015>
- Timothy J. Pac James Baldock Brendan Brodie Jennifer Byrd Beatriz Gil Kevin A. Morris Denice Nelson Jaydeep Parikh Paulo Santos Miguel Singer Alan Thomas, In situ chemical oxidation: Lessons learned at multiple sites First published: 28 February 2019, <https://doi.org/10.1002/rem.21591>
- Regenesys 2016, Principles of chemical oxidation technology for the remediation of groundwater and soil - Design and Application Manual V.4.0, 2016, consulted at [https://regenesys.com/en/techinfo/regenox-application-manual/USEPA\\_1994](https://regenesys.com/en/techinfo/regenox-application-manual/USEPA_1994), In Situ Chemical Oxidation (ISCO) treatment technology resource guide, EPA/542-B-94-007, freely downloadable at [https://www.epa.gov/sites/production/files/2015-08/documents/ISCO\\_tt\\_res\\_guide.pdf](https://www.epa.gov/sites/production/files/2015-08/documents/ISCO_tt_res_guide.pdf)
- USEPA 1997, Analysis of Selected Enhancements for In Situ Chemical Oxidation, EPA-542-R-97-007, consulted at <https://clu-in.org/download/remed/ISCOenhmt.pdf>
- USEPA 1998, Field Applications of In Situ Remediation Technologies: Chemical Oxidation <https://www.epa.gov/sites/production/files/2015-04/documents/chemox.pdf>
- USEPA 2006, In-Situ Chemical Oxidation Engineering Issue, August 2006, EPA/600/R-06/072, consulted at <https://nepis.epa.gov/Exe/ZyPURL.cgi?Dockkey=2000ZXNC.TXT>
- USEPA 2012, [https://clu-in.org/download/Citizens/a\\_citizens\\_guide\\_to\\_in\\_situ\\_chemical\\_oxidation.pdf](https://clu-in.org/download/Citizens/a_citizens_guide_to_in_situ_chemical_oxidation.pdf)
- Muhammad Usman, Oriane Tascone, Victoria Rybnikova, Pierre Faure, Khalil Hanna, 2017, Application of chemical oxidation to remediate HCH-contaminated soil under batch and flow through conditions. DOI 10.1007/s11356-017-9083-5
- John Vijgen, Christian Egenhofer 2009, Lethal Obsolete Pesticides. A ticking time bomb and why we have to act now [https://obsoletepesticides.net/site/wp-content/uploads/resources/reference/a\\_ticking\\_time\\_bomb\\_english\\_.pdf](https://obsoletepesticides.net/site/wp-content/uploads/resources/reference/a_ticking_time_bomb_english_.pdf)



European Union Network for the Implementation  
and Enforcement of Environmental Law

# Annex 1

---

## In Situ Chemical Oxidation – Case studies

IMPEL Project no. 2020/09



## 1. Contact details - CASE STUDY: ISCO n.1

<b>1.1 Name and Surname</b>	Marcello Carboni
<b>1.2 Country/Jurisdiction</b>	Italy
<b>1.3 Organisation</b>	REGENESIS
<b>1.4 Position</b>	Regional Manager, Europe
<b>1.5 Duties</b>	Coordination of Sales and Technical teams within Europe
<b>1.6 Email address</b>	mcarboni@regenesi.com
<b>1.7 Phone number</b>	+39 335 5867213



## 2. Site background

### 2.1 History of the site: Challenges and Solution

Site located in Veneto Region, Italy

A fuel tanker truck over-turned on a small road in northern Italy, spilling over 36,000L of diesel and petrol. The fuel impacted a canal, flood defences, soils and groundwater in the immediate vicinity.

The accidental event happened the 25th August 2017.

Emergency oil spill response was carried out, with impacted soils and the road surface removed and replaced. An underground pipeline was flushed out and sorbent booms were placed in the adjacent canal to catch and remove the oil.

A site investigation was completed concurrently with the oil-spill response in order to identify the subsurface contamination, build an initial Conceptual Site Model (CSM) and develop plans for remediation. MTBE, petroleum hydrocarbons (TPH) and BTEX were found to be within the soil – concentrated within the capillary fringe.

The groundwater was also found to be impacted and requiring remediation. A remedial options appraisal was completed, considering technical feasibility, sustainability, time and cost and a combined in situ chemical oxidation (ISCO) and enhanced aerobic natural attenuation (ENA) approach was chosen.

Main challenges of the site are related to:

- Urgency to complete remediation and allow area to go back to original conditions
- Public areas, no services available,
- No presence of fences, no surveillance
- Presence of MTBE (highly mobile) in a recent pollution event poses risk for rapid formation of plume of big size
- Different matrices interested: vadose zone soil, soil in capillary fringe, groundwater

## 2.2 Geological and hydrogeological setting

- Intercalation of fine sands with silts
- Unconfined aquifer with groundwater table at 2.5 m BGL
- Bottom of the aquifer at 5-6 m BGL (clay)
- Unknown specific data on conductivity and porosity
- Hydraulic gradient approx 0.5%

NOTE		CAMPIONI			LIVELLO ACQUA	PROF. FORO	PROF. RIVEST.	ASSISTENTI	
		● SPT	○ CAMPIONI RIMANEGGIATI	■ CAMPIONI INDISTRUGIATI	DATA	M. da S.P.		R. Sacchetti, A. Pini	
					05/01/17	100m	±0,0m	±0,0m	
								OPERATORE G. Rossi	
mt.	QUOTA da P.C.	SIMBOLOGIA	CAMPIONI			DESCRIZIONE STRATIGRAFICA	PROF. (m)	TUBO (m)	PROF. (m)
			TIPO	NUM.	PROF.				
	0,20								
1									
	1,40								
2									
	2,80								
3									
	3,80								
4									
	4,70								
5									
	5,20								
6									
	8,70								
9									
	9,40								
10									
	10,00								

## 2.3 Contaminants of concern

- Soil impacted with TPH and BTEX
- Groundwater impacted with MTBE and TPH
- Targets for soils: CSC residential areas:
  - C>12: 50 mg/kg
  - C<12: 10 mg/kg
  - B: 0.1
  - T: 0.5
  - EB: 0.5
  - X: 0.5
- Targets for groundwater: CSC:
  - TPH: 350 µg/l
  - MTBE: 40 µg/l
- Exceedings in soil in table below
- Exceedings in groundwater <1 mg/l for both TPH and MTBE

Campione	DATA	IDROCARBURI PESANTI C>12	IDROCARBURI LEGGERI C<12	BENZENE	TOLUENE	ETIL BENZENE	XILENI
		mg/kg					
FS1 VASCA	29/08/2017	1564	41	< 0,01	0,03	0,23	3,05
FS2 VASCA	29/08/2017	1703	52	0,06	3	1	2
M5C3 (2-2,4m)	04/09/2017	11327	361	0,21	5,54	2,23	3,41
M4C3 (2-2,8m)	04/09/2017	5094	39	< 0,01	0,02	0,04	0,41
PZ7C (2,0-3,0)	07/09/2017	118	8	< 0,01	< 0,01	< 0,01	0,01
PZ6C (2,0-3,0)	06/09/2017	246	15	< 0,01	< 0,01	< 0,01	0,03
CSC Tab. 1 Colonna B		750	250	2	50	50	50
CSC Tab. 1 Colonna A		50	10	0,1	0,5	0,5	0,5



## 2.4 Regulatory framework

- In Italy, CSC values define potentially contaminated sites. These are table limits.
- You can run risk assessment to find CSR: risk based threshold values, which can be less stringent as CSC and define site specific goals
- In this case, due to the limited size of the site, risk assessment has not been performed. Therefore targets for the remediation equal the national wide table limits CSC, specified at point 2.3
- A remediation plan needs to be submitted to the competent local authorities.
- Once the remediation plan has been submitted, the Municipality needs to call a meeting for its discussion, together with other technical and administrative authorities.
- If the project is approved, the proponent needs to pay a guarantee and then can start the works within the timeframe defined in the approval

## 3. Laboratory-scale application in field

### 3.1 Laboratory scale application

- Laboratory testing was not required and has not been performed
- Lab testing is seldom required by clients or authorities in Italy, and they are rarely performed
- Lab testing rarely can be useful for scaling up on site, and frequently is not representative, as it is difficult to simulate site conditions on a lab scale.
- If needed, a field pilot test, of small size, can provide at approximately the same cost more reliable and representative information.





## 4. Pilot-scale application in field

### 4.1 Main treatment strategy

- No pilot activity has been performed in this site
- This is because of the limited size of the site, and also for necessity of arriving to closure as soon as possible
- Therefore the strategy, the dosing and the activities have been designed based on previous experience on similar sites.



## 5. Full-scale application

### 5.1 Main Reagent

- General strategy was the use of ISCO coupled with EAB on both fringe soil and groundwater
- The strategy was selected after a multicriterial analysis comparing different strategies, taking into account logistics, timing, efficiency, consolidation of the technique, costs.
- The selection has been made thanks to the fact that no installation of active plants was needed, which would have been difficult to install and maintain on a public area without surveillance, the ease of use and the minimization of site activities
- RegenOx<sup>®</sup> is the ISCO agent selected. It is a patented formulation with catalyzed sodium percarbonate. Main reasons for selecting this specific reagent have been: ease of use, it is less dangerous compared to other ISCO agents (accidental contact with workers does not cause major issues), it is perfectly compatible with any kind of material (doesn't cause corrosion), and has a Strong desorbing effect (which was used in this case). Is also perfectly compatible with ORC oxygen release compound, which made it possible to co-inject together.
- Two different ways of application, at a distance of few days: first a direct application into excavation: product applied inside the excavation using the excavator, and mixing with saturated soil and groundwater. This caused an immediate desorbing effect (thanks to desorbing properties of RegenOx<sup>®</sup>), and direct recovery of LNAPL. At the end ORC was directly applied to excavation.
- Total size of excavation: 70 m<sup>2</sup>. Dosage: RegenOx<sup>®</sup> Part A (based mainly on sodium percarbonate) 220 kg; RegenOx<sup>®</sup> Part B (catalyst, based on iron silicate): 110 kg. ORC (calcium peroxide) 125 kg.
- Secondly, application by direct push has been made in the areas surrounding the excavation. It has been co-applied again RegenOx<sup>®</sup> + ORC, in capillary fringe and groundwater.
- It has been applied on a regular grid with distance of 3 meters,
- Total of 16 injection points, treatment over a layer of 2 meters (from 2 to 4 m BGL)
- Dosage per single point: RegenOx<sup>®</sup> Part A: 18 kg; RegenOx<sup>®</sup> Part B: 18 kg; ORC-Advanced 25 kg.
- The RegenOx<sup>®</sup> has been dissolved in water, forming a solution of 380 litres per



point. Usual dilution factors used for this reagent is 4-8% of RegenOx<sup>®</sup> Part A mass in water. After complete dilution, RegenOx<sup>®</sup> Part B is added (it is already a liquid/gel)

- Immediately after this, ORC powder has been put in water, and mixed, forming a slurry, for a volume of 125 litres per point.
- All field works have been performed in 1 week time.

## 5.2 Additives

- RegenOx<sup>®</sup> is a bicomponent ISCO agent
- In order to make reactive the sodium percarbonate (RegenOx<sup>®</sup> Part A), it is needed to have a catalyst (RegenOx<sup>®</sup> Part B).
- Usual dosages for RegenOx<sup>®</sup> Part B range from 50% to 100% of RegenOx<sup>®</sup> Part A. In this case it has been applied 50% in the excavation and 100% in direct push
- RegenOx<sup>®</sup> Part B is a liquid/gel composed mainly by iron silicate. Once in groundwater, it creates a matrix/surface on which both the oxidizer and the contaminants are attracted. This mechanism increases the probability and the velocity of direct contact between oxidizer and contaminants

## 5.3 Injection type

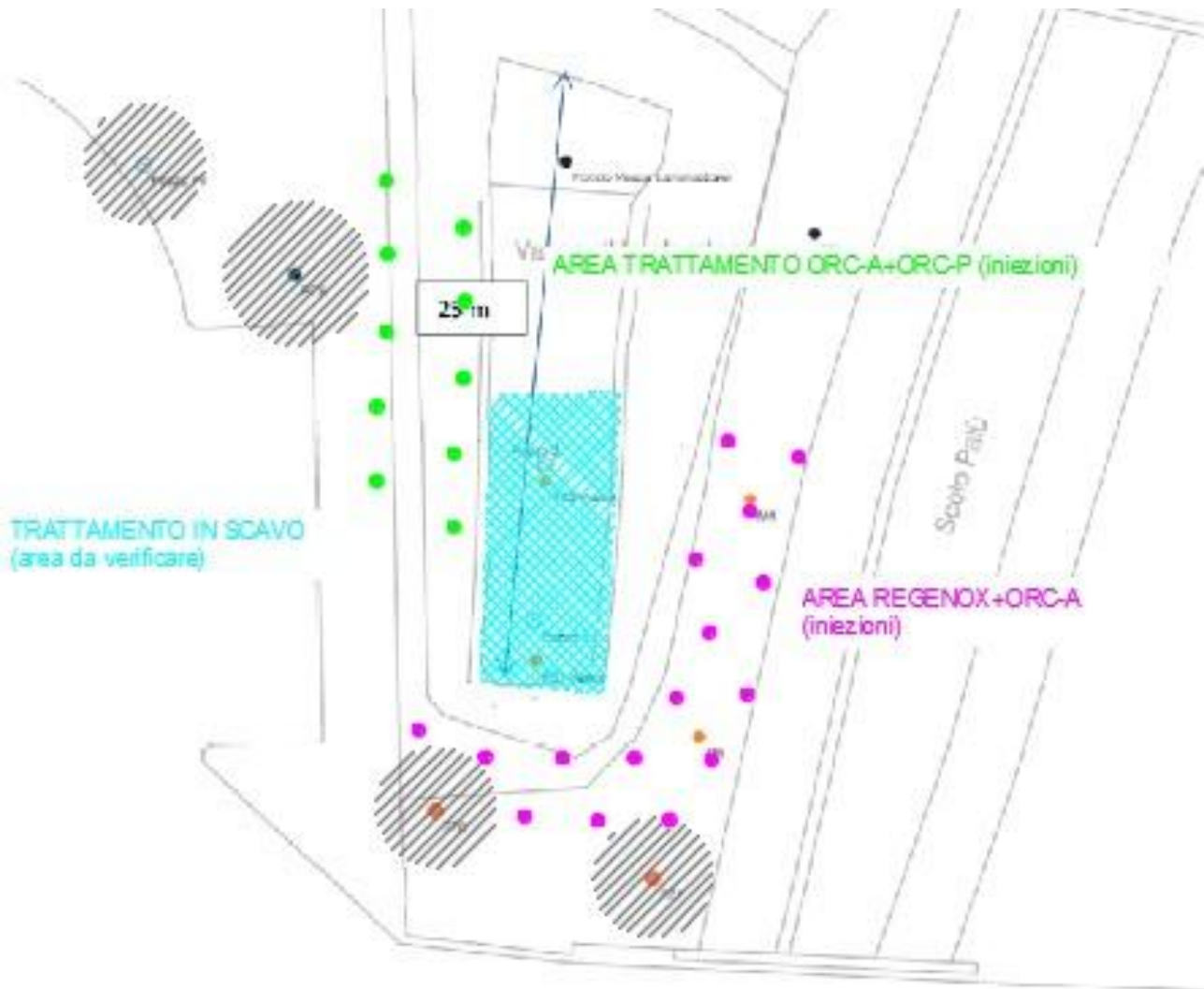

- 2 ways of application: direct application into excavation and direct push injection
- For direct push, regular grid of 3 x 3 meters distance. There was no direct verification of radius of influence, but has been selected this interdistance based on experience and observance in similar sites.
- Layer from 2 to 4 m BGL. Groundwater level is approx at 2.5 meters. So this layer covers fringe soil, periodical fluctuation zone of groundwater, and the first 1.5 meters of aquifer. Not all aquifer treated, as LNAPL tend to accumulate on first part.
- Just one single injection campaign performed. This is not very common for RegenOx®, most frequently we perform 2-3 campaigns at a distance of 1 month, to manage rebound. In this case the majority of the mass was MTBE, a hydrophilic



contaminant, which doesn't sorb that much to saturated soil, so 1 campaign has been considered sufficient.

- See previous paragraphs for dosing
- No fracturing used. Has been injected at relatively low pressure (2-4 bars). High pressure fracturing can cause formation of preferential pathways and lack of treatment in areas which ISCO agent can't access.

## 5.4 Radius of influence

- No direct measurement or calculation of radius of influence on this site
- The interdistance selected was 3 meters, estimating a ROI of approx 1.7-1.8 meters, therefore allowing for some overlapping between ROI in the treatment area
- This has been selected based on experience acquired on similar sites.
- Typical interdistances used for RegenOx<sup>®</sup> range from 3 to 4-5 meters. In this case the minimum value has been used, due to the relatively low permeability of the soil

## 5.5 Process and performance monitoring

- pH, redox, dissolved oxygen, temperature have been measured on site using multiparametric survey (field measurement)
- Parameters measured once per month for a period of 2 years, the same day as groundwater sampling for contaminants of concern
- Especially pH, redox and dissolved oxygen have been helpful in understanding the ongoing of the treatment
- Also monitoring of metals included, together with contaminants of concern. Same frequency and duration (once per month for 2 years)
- Analyzed in laboratory
- Metals searched: iron, manganese, total chromium, chromium VI. No variations have been noted that could be related to the treatment.

## 6. Post treatment and/or Long Term Monitoring

### 6.1 Post treatment and/or Long Term Monitoring

Fig. 7 MTBE monitoring results over time

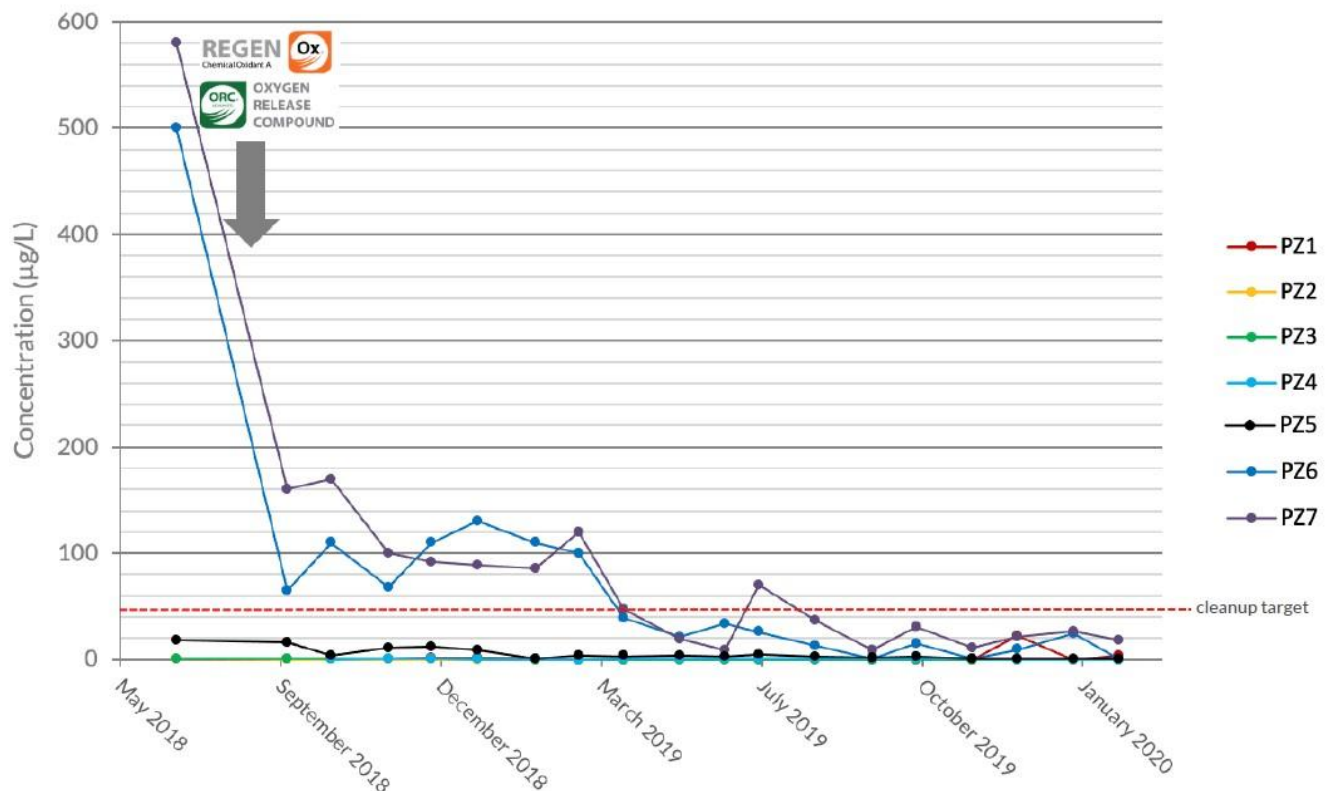

- Contaminants of concern monitored each single month for 2 years after application.
- Contaminants monitored: TPH, BTEX, MTBE, ETBE
- After the 2 years monitoring, formal compliancy of the site observed (reduction of contaminants of concern, and observance of no rebound in the following period). This was achieved in February 2020.
- After that, there is an additional post-operam monitoring period (still ongoing) of 2 year, with analysis every 3 months, to confirm that no increase of concentrations is observed.
- Also soil in capillary fringe has been tested for compliance after treatment. This has been performed through 4 soil borings, and analysis for compliancy of CSC, which was achieved in all 4 points.
- For groundwater, main contaminant was MTBE. TPH, originally present in groundwater above CSC, was already below CSC before ISCO application, probably thanks to the primary removal of source (excavation) made as emergency measurement (MISE)

- For groundwater, Pz5 Pz6 Pz7 are the wells inside the treatment area. The others are more downgradient.

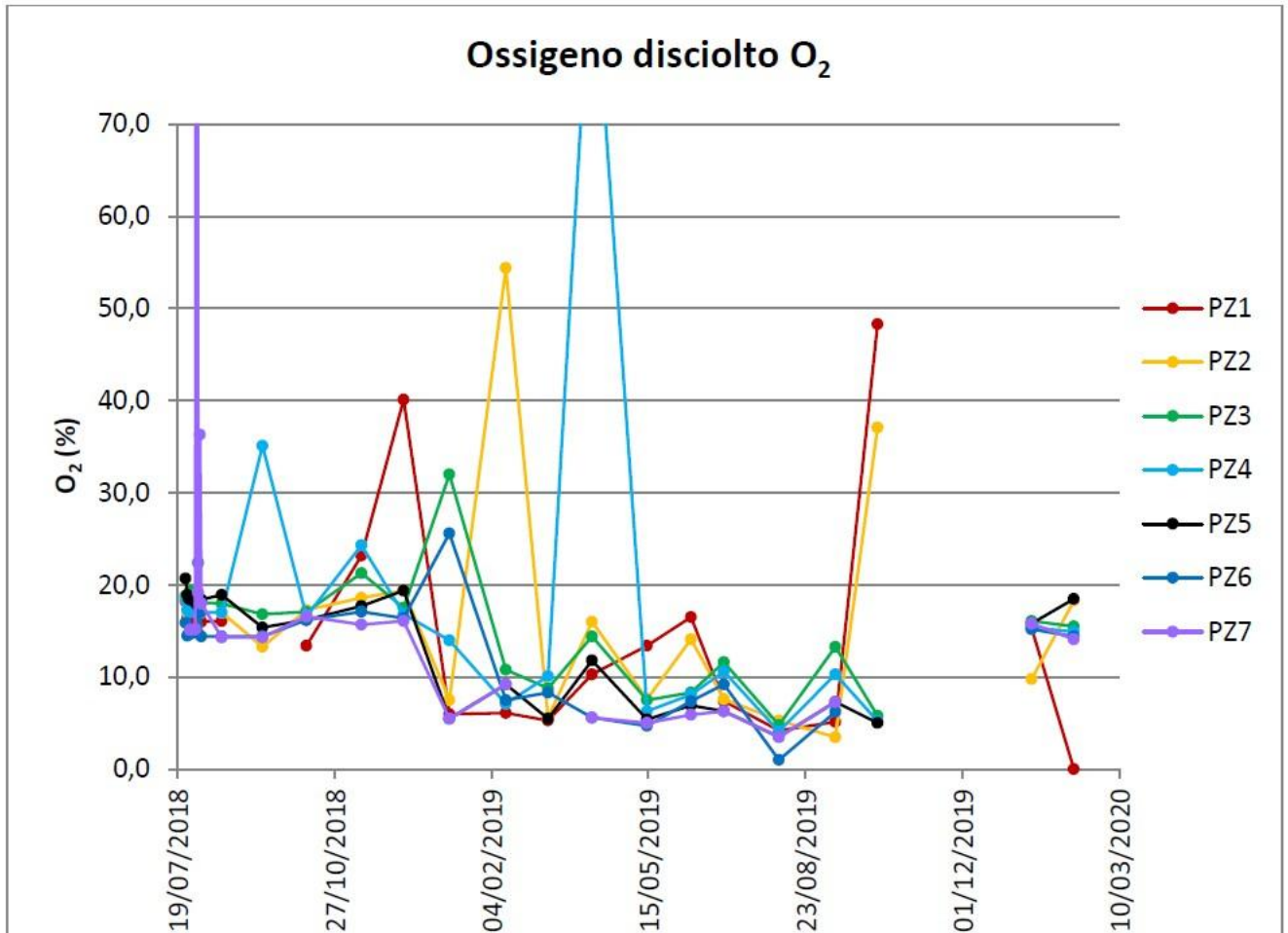

## 7. Additional information

### 7.1 Lesson learnt

- Very effective and rapid treatment. This is much faster compared to usual timing on treatment of groundwater in Italy, due to usually slow bureaucratic process
- Only 2 years between contamination event and formal achievement of compliancy of the site.
- Quick process has been achieved thanks to management of some parts in parallel (emergency activities and investigation)
- Also direct involvement and open discussion with local authorities was crucial for getting authorization on time
- Velocity of the process was crucial for not allowing formation of a bigger plume.
- Area accessibility was difficult, being present canals, tanks and private





surrounding areas. Therefore the treatment areas have been adjusted accordingly, but this hasn't affected the treatment efficiency

- No other parameters measured apart from the ones already mentioned.

## 7.2 Additional information

- Experience is very important, and is usually acquired thanks to management of many sites
- Field pilot test is highly recommended in any case, but it could be avoided for small sites like this one
- Dosing and design can't be based only on stoichiometry. Anyway, stoichiometry needs to be based on total contaminant mass (dissolved phase, sorbed phase to soil, NAPL), and not all of them are always directly known. For example in Italy saturated soil is never analyzed, and this is where the majority of the mass usually stands. This means that the mass of contaminant can be an imprecise estimation.
- Apart from stoichiometry, other factors on which to be based are distribution of the reagent, and minimum dosage required.
- Before getting in charge for an ISCO design, it needs to be evaluated if the technology is feasible. This needs to be done taking into consideration: geology, concentrations, targets, depth, accessibility of the area.
- The selection of the specific reagent can't be based only on reactivity, but needs to take into account longevity, distribution and ease of use. There are general rules and outlines, but is preferable to make these evaluations site-specific.

## 7.3 Training need

- I think the most useful thing is to get many examples of treatments done, in order to have an idea of how an average treatment should look like
- Too many times I see treatments performed using unrealistic designs, meaning interdistance between points too wide, wrong application method (i.e. gravity feeding of wells), very low quantities of amendments. In some cases there are examples of distances that could not be considered applicable in any case.
- Workshops and webinars are probably the most effective ways for training
- Visit to some sites where application is ongoing also is a very useful instrument to have a good idea of what is being done.

## 1. Contact details - CASE STUDY: ISCO n.2

<b>1.1 Name and Surname</b>	Federico Caldera
<b>1.2 Country/Jurisdiction</b>	Italy
<b>1.3 Organisation</b>	Mares S.r.l.
<b>1.4 Position</b>	Analista Sviluppo & Compliance
<b>1.5 Duties</b>	Sanitary and environmental risk assessment, innovative remediation and characterization technologies development
<b>1.6 Email address</b>	<a href="mailto:federicocaldera@maresitalia.it">federicocaldera@maresitalia.it</a>
<b>1.7 Phone number</b>	+39 3497616386

## 2. Site background

### 2.1 History of the site: Challenges and Solution

The site is a gas station, with an adjacent private property in a city of northern Italy, where at least starting from 1959, the marketing of petroleum products for motor vehicles, refuelling of motor vehicles, sale of lubricants and oil change of cars have been carried out. A contamination of TPH and BTEX affecting soil and groundwater (with also LNAPL) was found there in 2006. Thus a groundwater and unsaturated soil remediation plant was installed using MPVE technology. The project approved by the local authorities provides, where the remediation interventions through MPVE have not reached the identified remediation objectives within the set time frame, a Second Remediation Phase through the possible application of ISCO technology. So ISCO was chosen in order to remediate the presence of MTBE in groundwater outside the site.





## 2.2 Geological and hydrogeological setting

The site is located on the southern shore of Lake Maggiore, in a sub-flat area. The Quaternary deposits constituting the subsoil of the study area are characterized by fine sands and silty sands of fluvial and lake origin.

The area in question is located in an area characterized by the presence of alluvial, current fluvial and fluvio-glacial deposits with little or no surface alteration layer.

The gas station area hosts a water table with an average subsidence of 3.5 m b.g.s. and outflow facing Lake Maggiore towards the east quadrant.

## 2.3 Contaminants of concern

As anticipated the historical contamination affected both soil and groundwater, with BTEX, TPH and MTBE as CoCs.

After the first phase of the remediation the groundwater samples showed the presence of MTBE, downgradient outside the site, with concentrations historically ranking up to about 1000 micrograms per liter.

## 2.4 Regulatory framework

In Italy the environmental regulatory system is regulated by Legislative Decree No. 152/06 and for fuel stations by the Ministerial Decree No. 31/15. The target value for MTBE is set equal to 40 micrograms per liter. For the implementation of ISCO technology with subsequent injections of chemical reagents in groundwater (as well as for the implementation of any remediation plan) the approval by local authorities is needed.



## 4. Pilot-scale application in field

### 4.1 Main treatment strategy

ISCO technology is a technique that involves injecting an oxidant into the subsoil to chemically treat polluting organic compounds and transform them into harmless substances.

The execution of the field test had a dual purpose: to verify the applicability of the chemical oxidative treatment against residual contaminants present in the groundwater (MTBE) and ascertain the path of the oxidizing solution in the subsoil, in order to dimension the interventions planned for the second phase of remediation.

The solution used is composed of an oxidizing complex based on sodium persulfate activated with calcium peroxide.

The chemical reactions caused by the use of this specific compound are:

- direct chemical oxidation in the short term;
- biological degradation in the long term.

Sodium persulfate breaks down in water generating persulfate anions ( $S_2O_8^{2-}$ ), creating a strongly oxidizing alkaline environment.

The persulfate oxidation reactions involves the transfer of 2 electrons and is influenced by the concentration of anions, pH and oxygen.

In order for the contamination to degrade, the persulfate anion must be activated in order to generate the sulfate radical. The activated persulfate increases its oxidizing power, as the radicals are molecular fragments with an extremely reactive unpaired electron.

As for the biological action in the long term, the generic degradation of hydrocarbon compounds is the work of sulfur-reducing bacteria.

### 4.2 Additives

The activation energy of the persulfate is provided by calcium peroxide, which also has the function of regulating alkalinity (restoring a basic environment) and slowly releasing hydrogen peroxide and calcium hydroxide, with formation of hydrogen peroxide.

Hydrogen peroxide breaks down into oxygen and water, playing the role of a source of oxygen necessary for the decomposition of hydrocarbons.

The redox potential of sodium persulfate is 2.12 V, and it is the strongest oxidant of the peroxide family.



### 4.3 Injection type

The pilot test was performed by injecting in the subsoil an oxidizing solution, consisting of the commercial product diluted to approximately 10% with water, at 10 injection points (PI01 to PI10): 2 spaced 5 m each other near PZ12 and 8 spaced 5 m each other in a grid, compatible with the underground utilities, around PZ11 (see picture below).

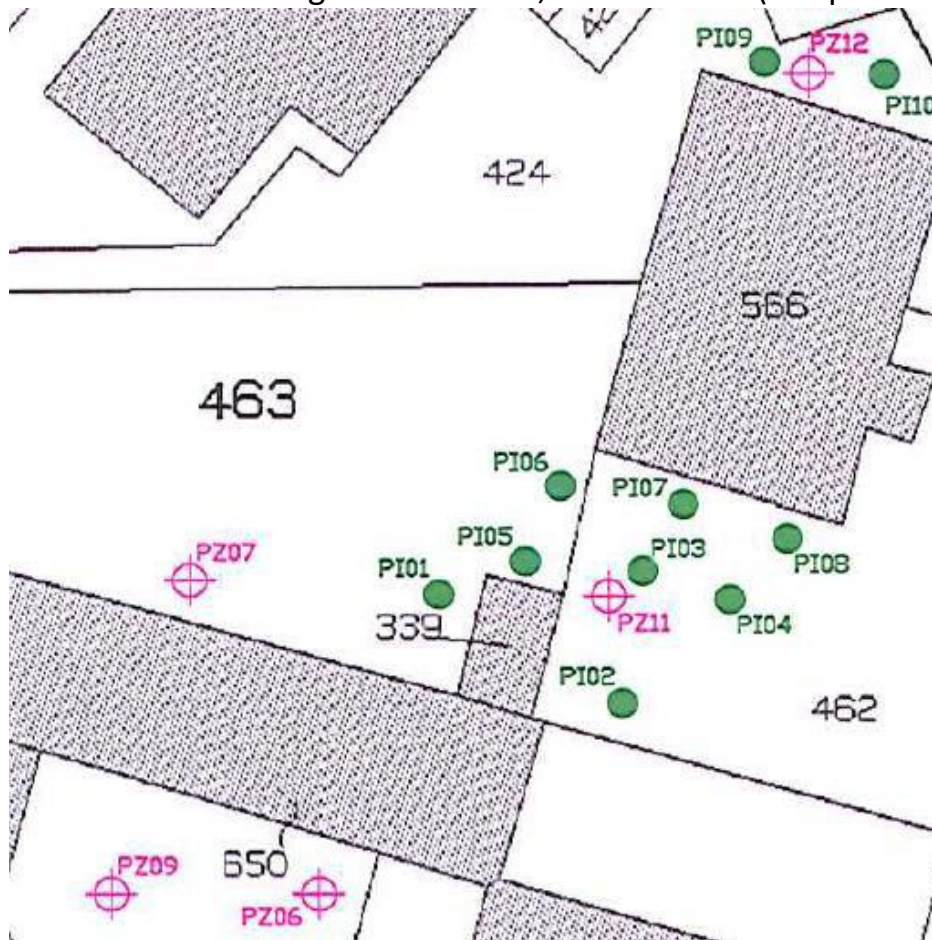

The injection took place using a direct-push technique, which involved driving a 1" hollow shaft into the subsoil, from whose terminal filter tip the oxidizing solution was injected under pressure at pre-established depths.

During the test, a solution consisting of about 2.7 m<sup>3</sup> of water mixed with 300 kg of the product was introduced into the aquifer for each of the 10 injection points.

Along the 10 verticals 7 sub-injections were carried out, proceeding in ascent from the bottom upwards in steps of 1 meter, i.e. from the bottom of the hole, located about 9 m b.g.s., up to the capillary fringe, about 3 m b.g.s.

The total quantity of oxidizing solution used at the end of the test was approximately 27 m<sup>3</sup> of water and 3 tons of the commercial product.

## 4.4 Radius of influence

The oxidant solution injected into the aquifer immediately generated positive redox potentials in all the monitoring points considered with values, gradients and longevity directly proportional to the distance between the monitoring points and the intake area, with effects observed also in PZ07 at about 10 m from the nearest injection point and in PZ06 at about 15 m from the nearest injection point (see the picture below with ORP values observed after the injection of oxidant solution). Moreover, the infiltration and drainage capacity of the oxidizing solution was not affected by the fine particle size that characterizes the subsoil in question (sandy silt and silty sand). To confirm this, in the multiple injection phase by direct-push, with a distance between the injection points of about 5 m, there were no problems of soil super saturation and it was therefore possible to inject all the quantity of oxidizing mixture expected, so such distance between the injection points was able to guarantee an overlap of ROI.

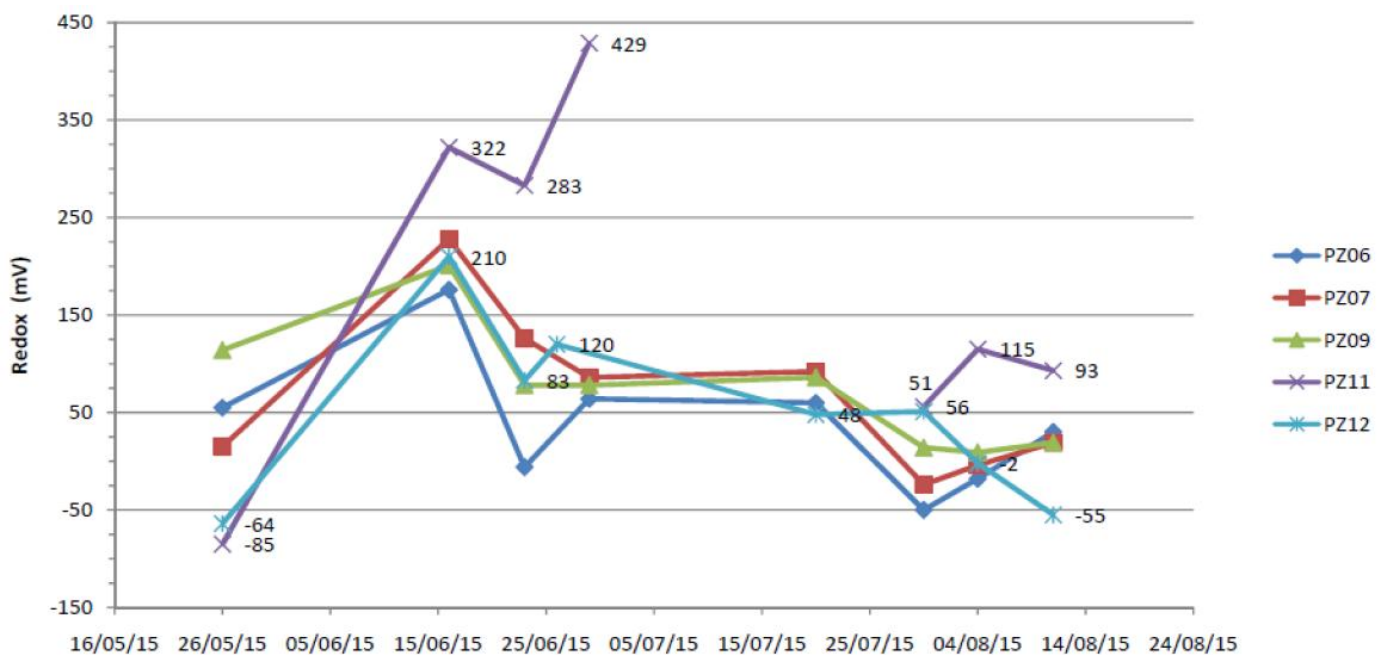



## 4.5 Control parameters

The monitoring of the chemical-physical parameters of the groundwater took place, on a network of 5 monitoring wells, with periodic frequency (approximately every 7 days), by measuring the pH and redox potential with a multiparameter probe directly in well at 3 increasing depths with respect to the free surface of the aquifer (at -1, -2 and -3 m below groundwater level), or on the ground level with field probe and flow cell for the water collected at -1 m depth compared to the free surface of the water table.

For the measurements carried out with a multi-parameter probe, it was also possible to record further parameters such as temperature, electrical conductivity, dissolved oxygen (expressed in mg/l and in %) and salinity.

It should be noted that after the injections of the oxidant solution into the aquifer it was not possible to measure the oxygen parameter dissolved in the water (mg/l and %) due to the possible aggressiveness of the product towards the measurement sensor.

The measures of chemical-physical parameters took place at the following time intervals:

- T0 baseline time (13 days prior to the first campaign),
- T1 time (4 days after the first injection),
- T2 time (11 days after the first injection),
- T3 time (17 days after the first injection),
- T4 time (38 days after the first injection),
- T5 time (48 days after the first injection),
- T6 time (53 days after the first injection),
- T7 time (60 days after the first injection).

The test included the analytical determinations on the whole piezometric network involved in the test, of the following parameters:

- Benzene, Ethylbenzene, Toluene, p-Xylene,
- Total hydrocarbons (such as n-hexane),
- MTBE,
- Lead,

in the following time intervals:

- T0 baseline time (13 days prior to the first campaign),
- T3 time (17 days after the first injection),
- T4 time (38 days after the first injection),
- T7 time (60 days after the first injection).





## 5. Full-scale application

### 5.1 Main Reagent

No changes from pilot test

### 5.2 Additives

No changes from pilot test

### 5.3 Injection type

In detail, the injection of an activator/buffer based on calcium peroxide in the hydrogeological valley area of the site was carried out by placing a solution in the subsoil, consisting of activator diluted 10% with water, at 10 injection points, named from PI01 to PI10. In the points where the injected reagent was absorbed with difficulty, in order to allow complete absorption of the same, i.e. in correspondence with points PI01, PI04 and PI10, new perforations were made as close as possible to the points of origin (i.e. PI01bis, PI04bis, PI10bis), see picture below. The injection took place using a direct-push technique which involved driving a 1" hollow rod into the subsoil, from whose terminal filter tip the solution was injected under pressure at predetermined depths.

During the activity, a solution consisting of 0.9 m<sup>3</sup> of water mixed with 100 kg of activator was introduced into the aquifer for each of the 10 injection points.

Along the 10 verticals 7 sub-injections were carried out, proceeding in ascent from the bottom upwards in steps of 1 meter, i.e. from the bottom of the hole, located about 9 m b.g.s., up to the capillary fringe, about 3 m b.g.s.

The injection of the oxidant solution with sodium persulfate in the PV area was performed by placing in the subsoil the solution, diluted to 7.5% with mains water, at 6 injection points, named by PI01 to PI06, see picture below.

The injection took place using a direct-push technique which involved driving a 1" hollow rod into the subsoil, from whose terminal filter tip the solution was injected under pressure at predetermined depths. The perforations were preceded from vacuum-digging pushed up to 1.5 m depth b.g.s. to verify the presence of any underground services.

During the activity, a solution consisting of approximately 1.7 m<sup>3</sup> of water mixed with

140 kg of sodium persulfate was introduced into the aquifer for each of the 6 injection points.

Along the 6 verticals 7 sub-injections were carried out, proceeding in ascent from the bottom upwards in steps of 1 meter, i.e. from the bottom of the hole, located about 9 m b.g.s., up to the capillary fringe, at about 3 m b.g.s.

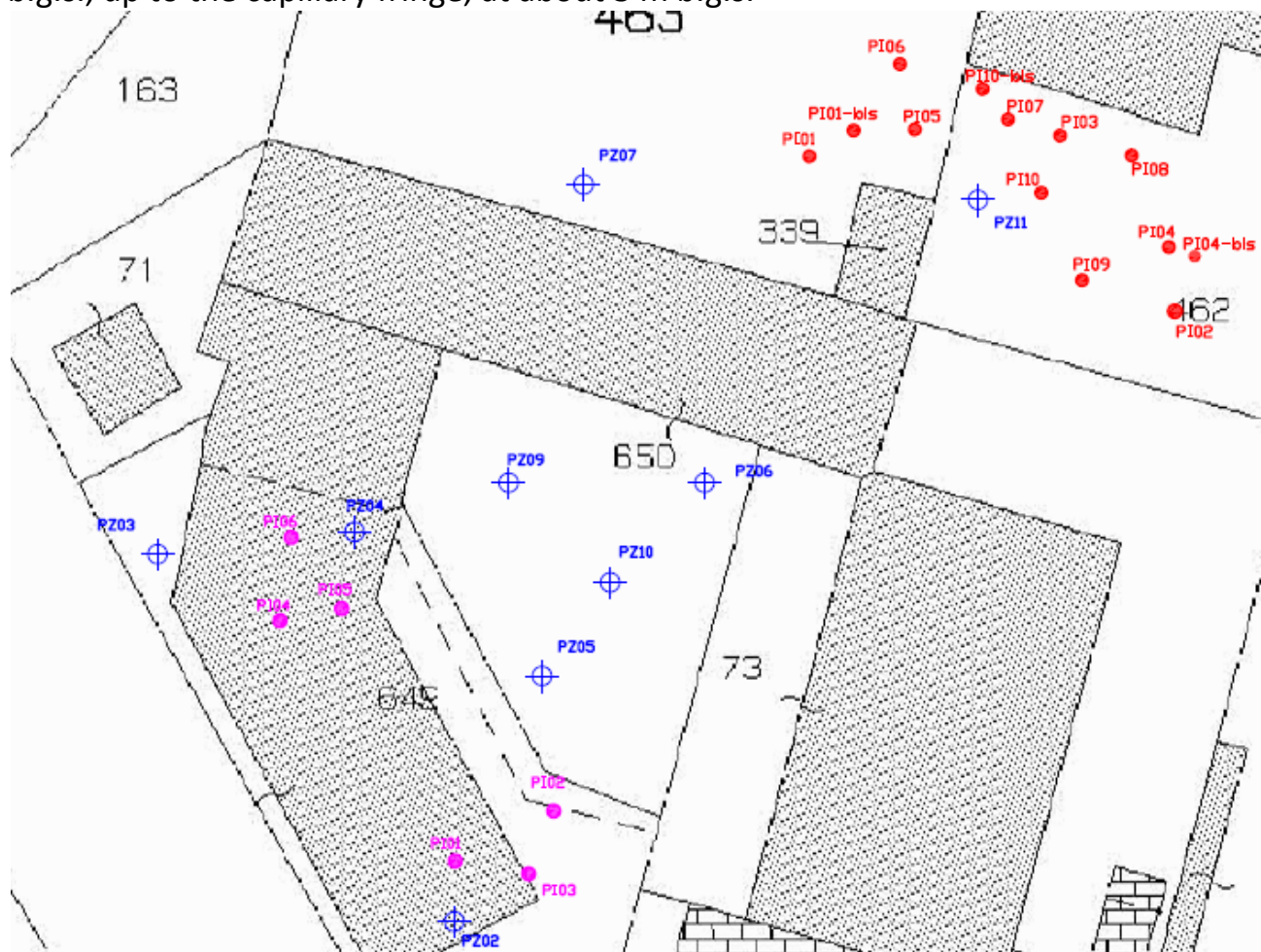

## 5.4 Radius of influence

Used the same interaxis of pilot scale.



## 5.5 Process and performance monitoring

The process monitoring of the second phase of remediation lasted more than 2 years. Here you may find the parameters, methods and frequencies.

Parameter	Method	Frequency
pH	Multiparameter probe	Twice a month for the first 2 months, then monthly
Temperature	Multiparameter probe	Twice a month for the first 2 months, then monthly
ORP	Multiparameter probe	Twice a month for the first 2 months, then monthly
DO	Multiparameter probe	Twice a month for the first 2 months, then monthly
Conductivity	Multiparameter probe	Twice a month for the first 2 months, then monthly
Groundwater level	Interface meter	Twice a month for the first 2 months, then monthly
BTEX, TPH, MTBE	Laboratory analysis	Twice a month for the first 2 months, then monthly

## 6. Post treatment and/or Long Term Monitoring

### 6.1 Post treatment and/or Long Term Monitoring

Post treatment and long term monitoring parameters are the same of the process and performance monitoring parameters. The results were periodically sent to local authorities described in technical reports. The persistence of MTBE in groundwater brought to the necessity of a third phase remediation plan.



## 7. Additional information

### 7.1 Lesson learnt

In the case study several challenges were encountered during the years. After the first phase of remediation, during which the LNAPL was recovered, the residual contamination, mainly MTBE in groundwater, was recalcitrant to the ISCO technology for several causes. Firstly, the remediation grid of injection points was located within the site property boundaries, because the surrounding private property did not allow the installation of any other remediation device. Secondly, the fine grained soil presumably in some case did not permit the reagents address properly the contamination.

### 7.2 Additional information

The keystone issue for a successful remediation is to gain a right conceptual site model, with a proper definition, in terms of extent, soil texture and presence of preferential flow pathways of the underground contamination source, in order to find adequate technology to properly address and remediate the CoCs.

### 7.3 Training need

E-learning/webinars in order to firstly understand the theoretical fundamentals of the technology (in terms of successful design and monitoring), but especially to be shown, through case studies, all the possible problems you can deal with during projecting, applying and monitoring the technology (lessons learnt by not perfect experiences).

## Glossary of Terms

<b>Term (alphabetical order)</b>	<b>Definition</b>
BTEpX	Benzene, Toluene, Ethylbenzene, p-Xylene
LNAPL	Light Non-Aqueous Phase Liquid
MPVE	Multi Phase Vacuum Extraction
MTBE	Methyl tert-butyl ether
TPH	Total Petroleum Hydrocarbon
VOC	Volatile organic compounds (VOCs)

## 1. Contact details - CASE STUDY: ISCO n.3

<b>1.1 Name and Surname</b>	Simone Biemmi
<b>1.2 Country/Jurisdiction</b>	Italy
<b>1.3 Organisation</b>	Arcadis Italia s.r.l.
<b>1.4 Position</b>	
<b>1.5 Duties</b>	
<b>1.6 Email address</b>	Simone.biemmi@arcadis.com
<b>1.7 Phone number</b>	+39 338 783 33 25



## 2. Site background

### 2.1 History of the site: Challenges and Solution

The site is a divested fuel station located in a flat area of northern Italy. The activity of the site was in the distribution of petroleum products for transport with temporary storage of the substances inside underground tanks. Site was divested and tanks removed 2 years before remediation start.

ISCO technology has been evaluated as applicable to the site due to the medium-low lithology, and the type of groundwater contamination, difficult to treat with other systems.

In this context ISCO technology could reach remediation goals faster than other technologies.

### 2.2 Geological and hydrogeological setting

Site sub-soil consists of sandy filled soil from ground level to 3 m, then sandy-silt layer from 3 to 5 m and clayey-silt from 5 to 7m b.g.l. Groundwater depth is approximately 2.5 meters below ground surface in a medium-low permeability ( $k = 1 \times 10^{-6}$  m/s) and low gradient.





## 2.3 Contaminants of concern

Groundwater samples indicated presence of Benzene (10 µg/L), Total Hydrocarbons (1,000 µg/L) and EtBE (1,000 µg/L) in internal area of the site, in tanks excavation area. Soil investigations after tank removal and excavation show no exceedance of regulatory limits, but the presence in saturated soil of ETBE (0.5 mg/Kg).

Remediation target for groundwater were defined with Sanitary and Environmental Risk Assessment. There are no remediation targets in internal area. At site boundary (POC's) is required to reach regulator limits for groundwater. In POC's PM2 and PM7 ETBE exceed the limit of 40 µg/L.

## 2.4 Regulatory framework

Remediation targets for groundwater were defined with Sanitary and Environmental Risk Assessment. There are no remediation targets in internal area. At site boundary (POC's) is required to reach regulator limits for groundwater. In POC's PM2 and PM7 ETBE exceed the limit of 40 µg/L.

The scope of remediation is to reach laws regulatory? limits in groundwater at POC's and decrease CoC concentrations in internal area in order to maintain POC's compliance.

ISCO Remediation strategy was detailed in a Remediation Design Document, approved by Regulators, that included preliminary laboratory test results.



## 3. Laboratory-scale application in field

### 3.1 Laboratory scale application

Laboratory batch tests were performed in order to evaluate:

- 1) Reagent effectiveness for ETBE concentrations decreasing
- 2) Potential for heavy metals mobilization

The test samples were prepared by mixing 100 g site soil, 500 mL groundwater with ETBE concentration of 1,000 µg/L and 1.8 g of sodium persulfate and calcium peroxide mixture. Blank samples (100 g site soil, 500 mL groundwater with ETBE concentration of 1,000 µg/L) was prepared too.

Test results shows ETBE decreasing by 28% after 3 days, 57% after 7 days and 77% after 14 days.

CrVI (not detected in blank sample) increase to 26.8 µg/L after 14 days. No potential for other metals mobilization was showed.





## 4. Pilot-scale application in field

### 4.1 Main treatment strategy

As described in literature, ISCO technology using persulfate activated by calcium peroxide is applicable at contamination detected in groundwater (at POC's ETBE, in internal area ETBE, Benzene and Hydrocarbons). Laboratory pilot test confirm good effectiveness of reagent for ETBE treatment.

Injections are compatible with the medium-low permeability (the mixture to inject is soluble) of the saturated matrix. Due to medium-low permeability it was decided to inject the reagent with tubes with valves (fixed manchette tubs) operating at high pressure.

Because the compliance of soil samples no other remediation and system was needed. Remediation strategy provides a first 6 month phase (pilot test) in internal area of site and a full-scale phase extended to POC's to be define after pilot test.

The product chosen for injection is a mixture with persulfate and an activator (calcium peroxide) that increase pH.

The mixture supports a two-fold mechanism for treating contaminants of concern. The reagent delivers one of the strongest chemical oxidants for short-term ISCO, and also provides electron acceptors (oxygen and sulphate) for longer-term biological oxidation. Persulfate is the strongest oxidant within the peroxides family, with an oxidation potential of 2.12 volts. As illustrated below, the direct oxidation half-cell reaction for persulfate involves a two-electron transfer:  $2S_2O_8^{2-} + 2H^+ + 2e^- \rightarrow 2HSO_4^-$

However in most cases, rapid destruction of the contaminant of concern requires that the persulfate be activated in order to generate sulphate radicals.

Sulphate radicals are powerful oxidizing agents, with an oxidation potential of 2.6 volts. Activated persulfate is catalyzed with the peroxide and base provide by the calcium peroxide:

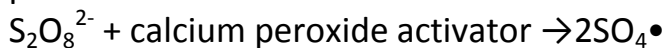

Activated persulfate can remain available in the subsurface for months providing a combination of power and stability.

The calcium peroxide provides several benefits. First, it imparts the alkalinity and peroxide needed to activate the persulfate using activation chemistry. Second, when mixed with water it provides a long-term, slow release source of hydrogen peroxide and calcium hydroxide.

The hydrogen peroxide that is slowly formed decomposes to oxygen and water, providing an extended oxygen source for subsequent bioremediation of petroleum hydrocarbons.



## 4.2 Additives

The approach used to activate the sulphate radical was elevating the pH, using calcium peroxide.

The calcium peroxide provides several benefits. First, it imparts the alkalinity and peroxide needed to activate the persulfate using activation chemistry. Second, when mixed with water it provides a long-term, slow release source of hydrogen peroxide and calcium hydroxide.

The hydrogen peroxide that is slowly formed decomposes to oxygen and water, providing an extended oxygen source for subsequent bioremediation of petroleum hydrocarbons.

## 4.3 Injection type

Injection was executed in internal area of the site in 2 tubes equipped by valves (fixed manchette tubs) between 2.5 (groundwater level) to 5 m b.g.l. in sandy-silt layer.

Injection points location was at different distance from monitoring wells (3m, 7m and 10m the nearest ones) in order to evaluate the ROI.

It was performed one injection of oxidant dosage of 175 Kg (20% water solution) for each point.

After 8 months monitoring would be start the full scale remediation.

## 4.4 Radius of influence

Radius of influence (ROI) provided for injection points: 3 meters. It was calculated on empirical methods



## 4.5 Control parameters

The measured parameters were pH, redox potential, temperature, dissolved O<sub>2</sub>, electrical conductivity (field instrumentation) BTEX, total Hydrocarbons, ETBE, metals (Cr, Cr VI, As, Cd, Fe, Mn, Hg, Ni, Pb, Cu, Zn) and Sulphates.

Monitoring frequency:

- 1st week - all points chemical-physical parameters (with field instrumentation)
- 2nd week - all points chemical-physical parameters
- after 1 month – all points groundwater analysis and chemical-physical parameters
- after 2 months - all points groundwater analysis and chemical-physical parameters
- after 4 months – all points groundwater analysis and chemical-physical parameters
- after 6 months - all points groundwater analysis and chemical-physical parameters

## 5. Full-scale application

### 5.1 Main Reagent

With respect to the pilot test it was confirmed the reagent (mixture of sodium persulfate auto activated with calcium peroxide). The dosage was confirmed in internal area and reduced by 40% near site boundaries in order to limit temporary effects of CrVI mobilization.

### 5.2 Additives

No changes from pilot to full scale application.



### 5.3 Injection type

1 injection campaign was performed in tubes equipped by valves between 2.5 (groundwater level) to 5 m b.g.l. in sandy-silt layer (like pilot test).

Basing on pilot test results full scale was performed using a triangular injection grid, with 4.5 m spacing. (21 injection points in a 450 m<sup>2</sup> area). Oxidant dosage of 175 Kg (20% water solution) for each point in internal area. Dosage was reduced by 40% for each of 6 injection point near site boundary.

### 5.4 Radius of influence

Radius of influence was calculated considering at what distance the monitoring wells were interested by injection effects during field pilot test. Pilot test ROI = 3m was confirmed.

### 5.5 Process and performance monitoring

The process monitoring is provided for 1 year.

The measured parameters are the same of pilot test: pH, redox potential, temperature, dissolved O<sub>2</sub>, electrical conductivity (field instrumentation) BTEX, total Hydrocarbons, ETBE, metals (Cr, Cr VI, As, Cd, Fe, Mn, Hg, Ni, Pb, Cu, Zn) and Sulphates.

Monitoring frequency:

- 1st week - all points chemical-physical parameters (with field instrumentation)
- 2nd week - all points chemical-physical parameters
- after 1 month – all points GW analysis and chemical-physical parameters
- after 2 months - all points GW analysis and chemical-physical parameters
- after 4 months – all points GW analysis and chemical-physical parameters
- after 6 months - all points GW analysis and chemical-physical parameters
- after 8 months – all points GW analysis and chemical-physical parameters
- after 10 months - all points GW analysis and chemical-physical parameters
- after 12 months - all points GW analysis and chemical-physical parameters



## 6. Post treatment and/or Long Term Monitoring

### 6.1 Post treatment and/or Long Term Monitoring

No long term monitoring is provided after monitoring plan described at 5.5.

## 7. Additional information

### 7.1 Lesson learnt

Monitoring of injection treatment show in field pilot test a first temporary phase (1 months) of CoC desorption from saturated soil and CrVI mobilization in groundwater (2-6 months) due to pH and redox increase. After that both CoC decrease and reach remediation goal and CrVI return to pre-injection level.

It was possible to define these effects both spatially and temporally due to the presence of a dense network of monitoring wells and frequent control campaigns.

The experience gained during pilot test was fundamental for the design of the full scale phase. Due to the precise technical information described, Regulators have approved the full-scale remediation without any prescription.

### 7.2 Additional information

The injection points and monitoring wells were drilled with continuous core drilling. It can allow to verify in the field the presence of layer with higher contamination, and for consequence is possible to evaluate increasing oxidant dosage in these levels.

## Glossary of Terms

Term (alphabetical order)	Definition
CoC	Contaminant of Concern
ROI	Radius of influence

## 1. Contact details - CASE STUDY: ISCO n.4

<b>1.1 Name and Surname</b>	Peter Freitag
<b>1.2 Country/Jurisdiction</b>	Austria
<b>1.3 Organisation</b>	Keller Grundbau Ges.mbH
<b>1.4 Position</b>	Lead of “Environmental Geotechnics” working group
<b>1.5 Duties</b>	Consulting, planning and execution of remediation projects
<b>1.6 Email address</b>	Peter.Freitag@keller.com
<b>1.7 Phone number</b>	+43 664 6144014



## 2. Site background

### 2.1 History of the site: Challenges and Solution

The site is located at the heart of Graz, Styria. From 1946 onward the area had various usages (Dyeing workshop, benzene laundry). Starting in 1958 Tetrachlorethylene was used in chemical laundry on site. For various reasons this TCE intruded into the subsoil, causing contamination on the site and neighbouring public space.

The planned remediation scheme consisted of an excavation with offsite treatment and horizontal well systems to treat contaminated groundwater in public space. After the remediation a residential building is planned.

The lateral support and the remediation of a contaminated subsoil zone below an existing building proved to be challenging. The first mainly due to constraints on available space, making the usage of larger drilling rigs for bored piles impossible. The later because excavation was not possible. HaloCrete® (HC) – an adaption of the jet grouting\*1 technique for in situ remediation – was used as a solution to both problems.

\*1 Jet grouting is a technique where a high-pressure jet – originating perpendicular from a rotating drilling rod - erodes soil material. The jet normally consists of a cement/water slurry. During retraction of the drilling rod this leads to the formation of columns in the subsoil. Working parameters are defined to securely achieve pre-defined diameters.

Normally this technique is used for underpinning or lateral support works in geotechnics.

### 2.2 Geological and hydrogeological setting

The geological situation can be described (simplified) in the following way: Manmade fills of various thickness (~3m) lie over a horizon of fine sands. Below that, the aquifer consisted of sandy, silty gravels. At approx. 7m bgl silts constitute the aquiclude.

Groundwater table can be found at around 6m bgl, with a gradient of 0,8%. Permeability was estimated to be around  $5 \times 10^{-4}$  m/s for the gravels.



## 2.3 Contaminants of concern

Tetrachlorethylene was found to be the main contaminant. Concentration data was given by the environmental planner, with highest concentrations of 14000 mg/m<sup>3</sup> found below the installation site of the washing machines.

Residual PCE in phase was deemed possible.

Most of the ISCO measures were conducted in a zone of approx. 3000 mg/m<sup>3</sup>

## 2.4 Regulatory framework

No special approval was needed.

As the ISCO operation was only a comparatively small part of the remediation no special target values were given. Lacking exact (on spot), in-situ measured concentrations it was agreed to analyse the columns for their content of TCE and compare it with estimated concentrations.

I'm not aware of the specific regulatory framework in place (federal country ("Bundesland") specific) and defined target values. These topics were taken care of by the overall planner.





## 3. Laboratory-scale application in field

### 3.1 Laboratory scale application

Due to time constraints – we've only been involved late in the project – we could only conduct batch tests together with our partners from the AIT (Austrian Institute of Technology).

We analysed for NOD of soil as well as two prospective geotechnical binders (ordinary Portland cements) needed for statical reasons. The soil samples were taken from different depth levels.

As oxidizing agents  $\text{KMnO}_4$  and  $\text{NaMnO}_4$  were tested, mainly for handling considerations (powder vs. liquid). Hereby no significant difference was observed after 24h. These tests were conducted on simulated column material, i.e. contaminated (site) soil samples + cement + oxidising agent

A target concentration of  $20\text{gKMnO}_4/\text{kg}$  column was recommended. This was based on the assumption of residual phase on site. In later discussions with the planner this value was reduced taking into considerations local variances and homogenization effects during the jet grouting process.

## 4. Pilot-scale application in field

### 4.1 Main treatment strategy

For this project no pilot-scale application was conducted. The feasibility of jet grouting had been proven in a research project ("HaloCrete" partly funded by the Austrian authorities)

HaloCrete was selected because it solved both structural (lateral support of excavation) and remediation (below buildings) challenges.  $\text{KMnO}_4$  was then selected because it can be easily introduced into the overall jet grouting process. It was added at the mixing plant for the cement slurry in granular form. From there operations were conducted as usual.

The only difference to standard applications was the accumulation of two different backflow slurries. One being from uncontaminated soil zones and the other from contaminated zones containing  $\text{KMnO}_4$ .

Works were planned to be finished after four weeks.





A picture of the site. Works are conducted below former washing machines. Backflow deeply covered purple by  $\text{KMnO}_4$

## 5.4 Radius of influence

Due to the jet grouting installation process, the radius was “pre-defined” and measured/controlled in-situ.





## 5.5 Process and performance monitoring

Apart from standard quality assurance (for jet grouting applications) no additional controls were required.

Control and monitoring of chemical parameters were not in the scope of Kellers work. The final proof of success on ISCO works was a direct TCE-concentration measurement on samples taken from core drillings at different depths.

## 7.3 Training need

This relatively new approach of using jet grouting as a means of delivery for ISCO reagents must be made more public in general.

Taking various boundary conditions into consideration it can be a feasible and economic approach for in-situ remediation.

What comes to mind are otherwise deep excavations in need of lateral support, source zones difficult to address with conventional injection techniques and synergistic effects with construction requirements. HaloCrete columns can be used statically like any other jet grouting body.

## 7.4 Additional remarks

I'm aware that this project differs widely from "ordinary" ISCO project, especially as ISCO was only part of a combined solution. Insofar I couldn't give an answer to every question in this survey as not all of them are applicable to our approach.

Nonetheless I hope that this contribution widens the perspective on techniques and possibilities already available for ISCO (or ISCR) applications.

## Glossary of Terms

Term (alphabetical order)	Definition
m bgl	m below ground level

## 1. Contact details - CASE STUDY: ISCO n.5

<b>1.1 Name and Surname</b>	Mara Dal Santo
<b>1.2 Country/Jurisdiction</b>	Italy
<b>1.3 Organisation</b>	Stantec
<b>1.4 Position</b>	Senior Technical Specialist
<b>1.5 Duties</b>	Environmental consultant
<b>1.6 Email address</b>	mara.dalsanto@stantec.com
<b>1.7 Phone number</b>	



## 2. Site background

### **2.1 History of the site: Challenges and Solution**

The site was a fuel retail site until 2015, its area is 1500 m<sup>2</sup> and it is located at 20 m above sea level in Northern Italy. Since 2015 it has been a parking area. MTBE contamination was detected during the preliminary environmental investigation carried out in order to prepare the complete demolition of the plant. It was hypothesized an oil leakage from tanks and/or from lines during the selling activities. ISCO technology was selected in order to manage the residual contamination. At first, in fact, the contamination was treated with EAB filter socks as emergency measures and with EAB product injection as per RAP. The planned RAP second injection was made with ISCO and not with EAB product, as assumed before, just to obtain a more effective contamination reduction and to close the environmental case. ISCO technology was selected in order to remediate groundwater and facing the difficulty in reaching the tight legislative target of 40 µg/l for MTBE.

## 2.2 Geological and hydrogeological setting

The site is characterized by alluvial plain sedimentation: silty-sand (see below “sabbia”) with clay-silt lenses, 0.5 to 1 m thick (see below “limo” and “argilla”). The groundwater level varies from 0.80 to 1.5 m bgl. The maximum depth reached by the drilling is 6.5 m bgl.

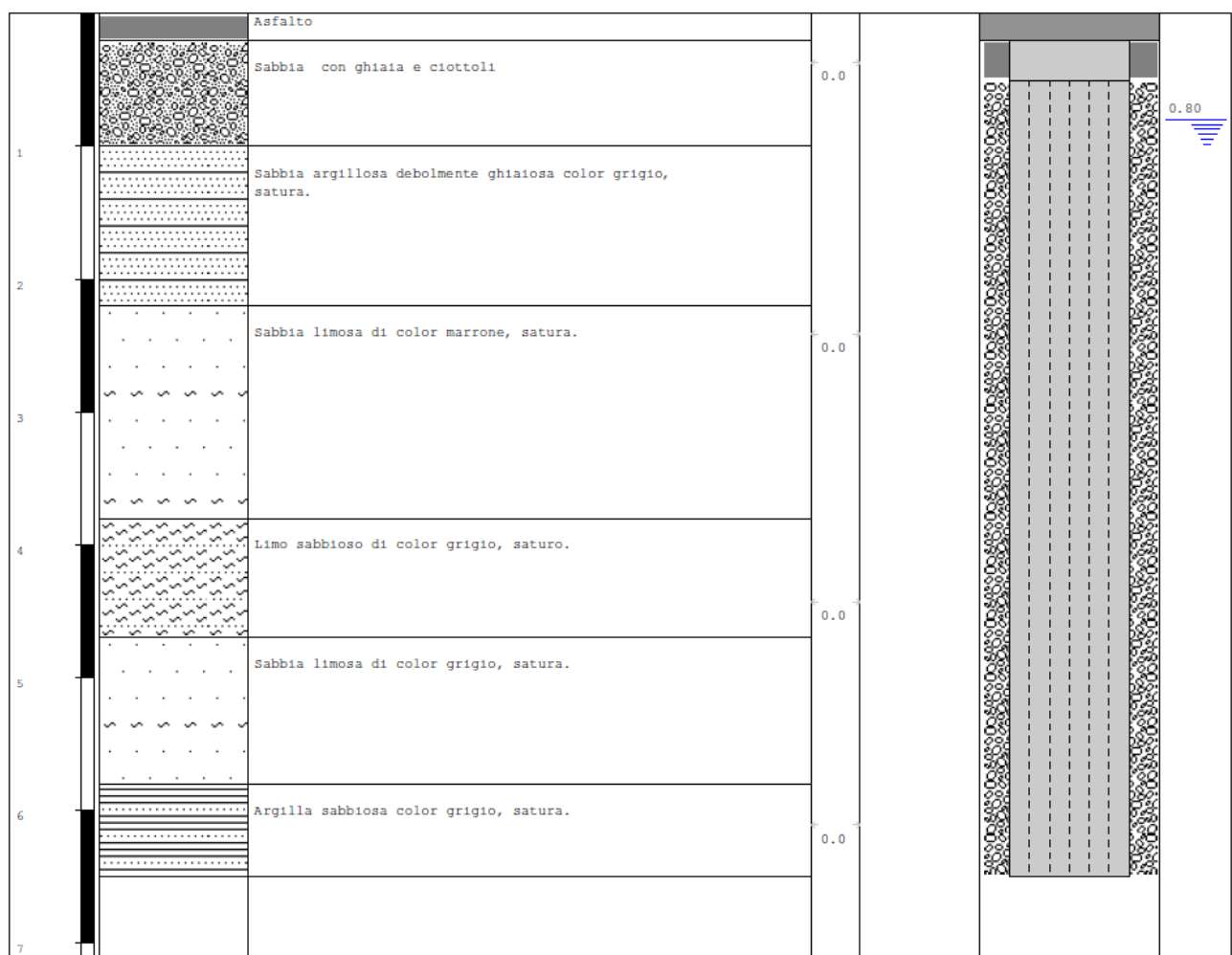

The local groundwater flow direction is W-E, the gradient 0.01, the hydraulic conductivity is medium (about  $10^{-5}$  m/s. This value is just an estimate, hydraulic tests were not performed)



## 2.3 Contaminants of concern

The maximum concentration measured during the planned monitoring for groundwater and for soil are displayed in the following table. These concentrations have been used as input parameters for the remediation design

CONTAMINANTS OF CONCERN (COCs)		
Constituent	GW (mg/L)	Soil (mg/kg)
MTBE	1.45	0.087
DRO	1	43.25

According to the historical data set, there are three monitoring wells with exceedances, all the other have total hydrocarbon and MTBE under the law limits. Here below the concentrations measured in the period from 2016 to 2017.

Denominazione		28/07/2016	14/11/2016	23/12/2016	30/01/2017	23/02/2017	06/04/2017	23/05/2017	DLgs 152/06 All 5 Tab 2
Parametro	U. M.								
Piombo	µg/L	< 0,1							0,1
COMPOSTI ORGANICI AROMATICI									
Benzene	µg/L	< 0,1	< 0,1	< 0,1	< 0,1	< 0,1	< 0,1	< 0,1	1
Etilbenzene	µg/L	< 1	< 1	< 1	< 1	< 1	< 1	< 1	50
Stirene	µg/L	< 1	< 1	< 1	< 1	< 1	< 1	< 1	25
Toluene	µg/L	< 1	< 1	< 1	< 1	< 1	< 1	< 1	15
p-Xilene	µg/L	< 1	< 1	< 1	94	< 1	< 1	< 1	10
ALTRE SOSTANZE									
Idrocarburi totali (n-esano)	µg/L	171	101	39	1068	30	43	42	350
MTBE (Metilterzbutiletere)	µg/L	172	52,5	159	154	72,7	73,6	83,6	40*
ETBE (Etilterzbutiletere)	µg/L	-	8,1	6	13,3	3,8	8,7	5,9	40*
Piombo tetraetile	µg/L	< 0,01	< 0,01	< 0,01	< 0,01	< 0,01	< 0,01	< 0,01	0,1*

Denominazione		05/08/2016	14/11/2016	23/12/2016	30/01/2017	23/02/2017	06/04/2017	23/05/2017
Parametro	U. M.							
Piombo	µg/L							
COMPOSTI ORGANICI AROMATICI								
Benzene	µg/L	< 0,1	< 0,1	< 0,1	< 0,1	< 0,1	< 0,1	< 0,1
Etilbenzene	µg/L	< 1	< 1	< 1	< 1	< 1	< 1	< 1
Stirene	µg/L	< 1	< 1	< 1	< 1	< 1	< 1	< 1
Toluene	µg/L	< 1	< 1	< 1	< 1	< 1	< 1	< 1
p-Xilene	µg/L	< 1	< 1	< 1	< 1	< 1	< 1	< 1
ALTRE SOSTANZE								
Idrocarburi totali (n-esano)	µg/L	< 30	43	45	< 30	< 30	< 30	< 30
MTBE (Metilterzbutiletere)	µg/L	1057	375	516	294	1310	33	1195
ETBE (Etilterzbutiletere)	µg/L	-	9,6	9,2	14	31,1	10,5	13,1
Piombo tetraetile	µg/L	< 0,01	< 0,01	< 0,01	< 0,01	< 0,01	< 0,01	< 0,01





Denominazione		28/07/2016	14/11/2016	23/12/2016	30/01/2017	23/02/2017	06/04/2017	23/05/2017
<b>Parametro</b>	<b>U. M.</b>							
Piombo	µg/L	< 0.1						
<b>COMPOSTI ORGANICI AROMATICI</b>								
Benzene	µg/L	< 0,1	< 0,1	< 0,1	< 0,1	< 0,1	< 0,1	< 0,1
Etilbenzene	µg/L	< 1	< 1	< 1	< 1	< 1	< 1	< 1
Stirene	µg/L	< 1	< 1	< 1	< 1	< 1	< 1	< 1
Toluene	µg/L	< 1	< 1	< 1	< 1	< 1	< 1	< 1
p-Xilene	µg/L	< 1	< 1	< 1	< 1	< 1	< 1	< 1
<b>ALTRE SOSTANZE</b>								
Idrocarburi totali (n-esano)	µg/L	< 30	< 30	50	< 30	< 30	< 30	< 30
MTBE (Metilterzbutiletere)	µg/L	<b>80.6</b>	<b>48.8</b>	18.4	< 0,5	< 0,5	32.1	<b>80.7</b>
ETBE (Etilterzbutiletere)	µg/L	-	4.9	1.5	3.5	2.6	2.6	6.6
Piombo tetraetile	µg/L	< 0,01	< 0,01	< 0,01	< 0,01	< 0,01	< 0,01	< 0,01

The clean-up goals are 40 µg/l for MTBE and 350 µg/l for total hydrocarbon expressed as n-hexane into groundwater.

## 2.4 Regulatory framework

In Italy, according to the D.Lgs 152/06 and DM 31/15, when a potential contamination is assumed or detected the site becomes a contaminated site and the owner or the “involved subject” has to inform the public authorities. The site must be characterized in order to define the conceptual model of the contamination. Then a risk analysis could be carried out in order to define site specific concentration limits. If the concentrations are above the concentration limits, defined by law or by site specific analyses, the site has to undergo a remediation.

In order to apply a chemical product in the ground the Public Authorities have to approve the Remedial Action Plan. In the case shown here the Authorities also allow to put filter socks as “emergency plan” stage and not as RAP, is it not common in all the Italian territories. Most regions allow the use of chemical compounds only under a RAP approval.

Here below the site history of the site related to the regulatory framework.

- May, 2015: execution of the preliminary investigation for the decommissioning of the fuel retail station
- June, 2015: transmission of the notification according to D.Lgs.152/06 and D.M. 31/15;
- July, 2015: decommissioning of the plant and starting of emergency activities (removal of the portion of soil surrounding the removed tanks, purging of water from the excavation and soil sampling from the walls and bottom of the



excavations);

- November, 2016: installation of socks for EAB
- April, 2017: replacement of socks for EAB
- July, 2017: RAP transmission
- December, 2017: PA approval of RAP.
- April, 2018: EAB product injection
- April, 2019: ISCO injection
- January, 2020: first of 4 planned quarterly groundwater sampling tested with PA in order to define the groundwater not contaminated
- June, 2020: groundwater sampling tested with PA
- September, 2020: groundwater sampling tested with PA
- November, 2020: groundwater sampling tested with PA
- December, 2020: execution of soil testing surveys in order to define the soil as not contaminated soil for all the site.

### 3. Laboratory-scale application in field

#### 3.1 Laboratory scale application

No laboratory scale application was done. The oxidant demand was calculated from site condition parameters such as lithology, contaminant concentrations, fraction of organic carbon, hydraulic conductivity, volumes of groundwater and soil to be treated. The calculation was made with a stoichiometric approach.

### 4. Pilot-scale application in field

#### 4.1 Main treatment strategy

The RAP considered two injection campaigns: the first was carried out with EAB product, the second with ISCO product. No pilot test was conducted onsite considering the very small area of the contaminated site (1500 m<sup>2</sup>). The second injection was sized based on the result of the first injection activity.



## 5. Full-scale application

### 5.1 Main Reagent

- The first treatment application started in April 2018 and consisted of the injection of EAB product through 8 direct push points. The selected product is a specially formulated time-released grade of calcium peroxide designed to assist in the aerobic bioremediation in soil and groundwater. A volume of 600 liter of slurry, prepared with water in a concentration of 25%, was injected into the subsurface through each direct push point. Totally, 1200 kg of dry powder of product were used.
- The second treatment application started in July 2019 and consisted of the injection of ISCO product through 8 direct push points. The selected product is a single, formulated product consisting of high pH-activated persulfate and calcium peroxide. A volume of 600 liter of slurry, prepared with water in a concentration of 25% was injected in the subsurface through each direct push point. Totally, 1800 kg of dry powder of the selected product were used.
- The amount of applied reagent was calculated based on a stoichiometric approach

### 5.2 Additives

The ISCO selected product is formulated to provide a self-activated persulfate oxidation system, therefore no additives were used beside the main reagent.

### 5.3 Injection type

Eight direct-push injection points to treat from 1 to 6 m bgl. The injection was done from top to down for each 0.5 m interval. In some intervals, it was difficult to inject all the reagent as planned, so the string was shifted to just below the interval in order to complete the injection.

## 5.4 Radius of influence

The radius of influence was estimated to be not less than 2 m, based on lithologies and injection method.

## 5.5 Process and performance monitoring

- Monthly monitoring for the first 3 months: MTBE (lab analysis) and chemical-physical parameters (measured onsite);
- Quarterly monitoring with extended analytical set: Total hydrocarbons, Benzene, Ethylbenzene, Toluene, Xylenes, MTBE, ETBE (lab analysis) and chemical-physical parameters (measured onsite).
- In the graph below there are the evolution of MTBE concentration during time. The two red arrows indicate the first EAB injection carried out on April 2018 and the second ISCO injection carried out on July 2019

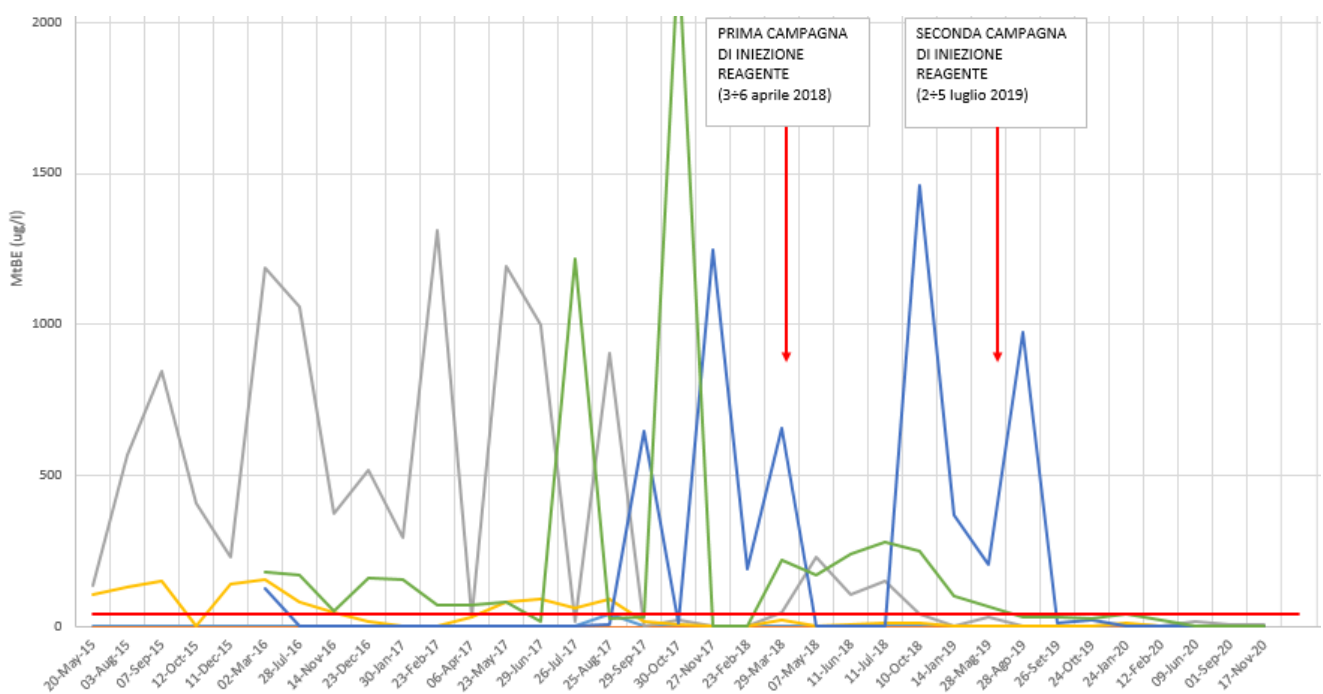



## 6. Post treatment and/or Long Term Monitoring

### 6.1 Post treatment and/or Long Term Monitoring

After 1 year from the ISCO injection job: quarterly monitoring with extended analytical set: Total hydrocarbons, Benzene, Ethylbenzene, Toluene, Xylenes, MTBE, ETBE (lab analysis) and chemical-physical parameters (measured onsite). After 4 monitoring campaigns without exceedances it will be possible to close the environmental case. (these conditions are case-specific and defined by the PA)

## 7. Additional information

### 7.1 Lesson learnt

The case study can be defined as a case of success since the goal of reducing the contamination below the threshold limits has been achieved and it will soon be possible to request closure of the environmental case. However, it is possible to make some considerations. The sending of the RAP to the authorities could have been done more quickly but, above all, the choice of an ISCO+EAB products since the first injection would have potentially allowed compliance to be achieved more quickly. This hypothesis could have been verified by laboratory or field tests.

### 7.2 Additional information

Given the modest size of the site and the concentrations of contaminants, the choice to implement the remediation by injection of reagents has been successfully performed in a relatively short time and has been shown to be relatively sustainable.

### 7.3 Training need

- It would be useful to have an e-learning training on these aspects: proper design of the remediation; use of laboratory and field tests and use of indicators to verify the progress of the remediation (taking into account not only chemical analysis).
- In addition, it may be useful to analyze and discuss case studies through workshops.



- It would be useful if this training were not provided only by reagent producers, even though they have produced a great deal of research and studies in the field, but rather by a synergic team containing various interests: the need to improve remediation products, to remediate effectively and quickly, and to be able to propose remediation that is effectively and well accepted by the PA.

## 7.4 Additional remarks

Really consider reagent injections remediation technology as a robust alternative to remediation plant technologies.

## Glossary of Terms

<b>Term (alphabetical order)</b>	<b>Definition</b>
EAB	Enhanced Aerobic Bioremediation
PA	Public Authority
RAP	Remedial Action Plan according to the Italian law "Progetto Operativo di Bonifica - POB"

## 1. Contact details - CASE STUDY: ISCO n.6

<b>1.1 Name and Surname</b>	<sup>1</sup> Gordon H. Bures <sup>2</sup> Alberto Leombruni <sup>3</sup> Mike Mueller
<b>1.2 Country/Jurisdiction</b>	<sup>1</sup> Germany <sup>2</sup> Italy <sup>3</sup> Austria
<b>1.3 Organisation</b>	<sup>1</sup> Sensatec GmbH <sup>2</sup> Evonik <sup>3</sup> Evonik
<b>1.4 Position</b>	<sup>1</sup> Technical lead – environmental fracturing <sup>2</sup> Authorized technical representative Italy and Spain <sup>3</sup> Business Development Manager EMEA
<b>1.5 Duties</b>	<sup>1</sup> Project engineer for the design and implementation of innovative, <i>in situ</i> remediation techniques and enhancement technologies <sup>2</sup> Responsible for high-level collaboration with environmental consultants, engineers, impacted site owners, regulators and the academic community <sup>3</sup> Manager of the Soil & Groundwater Remediation Technologies department as Business Development Manager (EMEA) at Evonik Active Oxygens. Based in Austria, responsible for high-level collaboration with environmental consultants, engineers, site owners, regulators and the academic community.
<b>1.6 Email address</b>	<a href="mailto:g.bures@sensatec.de">g.bures@sensatec.de</a> alberto.leombruni @dgextern.com mike.mueller@evonik.com
<b>1.7 Phone number</b>	<sup>1</sup> +49 (0)176 1389 0095 <sup>2</sup> +39 3895121600 <sup>3</sup> +43 6641803060



## 2. Site background

### 2.1 History of the site: Challenges and Solution

The subject site is situated near Frankfurt am Main, Germany on the grounds of a former chemical manufacturing facility which produced solvents for metalwork, cleaning chemicals, and specialty oils. Other facilities of environmental concern on the property included a former oils and chemicals storage building, as well as an underground storage tank and pipeline for the storage of industrial solvents.

The plant was in operation from the mid- 1960s until a fire destroyed it, causing the plant to cease operations in 1974. It is suspected that the fire and resulting explosion was a major factor in the release of contaminants to the subsurface environment. The property was subsequently acquired in 1985 by new owners who used the site for manufacture of industrial presses until 2014. Since then, the property is used for general warehouse storage, parking lot, and auto mechanic shop.



Site of former chemical manufacturing facility in Hessen, Germany

Significant challenges to the implementation of remedial measures at the site were the massive impacts of co-mingled contaminants of concern to underlying soils and groundwater including

- Chlorinated aliphatic hydrocarbons, primarily cis-Dichloroethylene (cDCE)
- Aromatic petroleum hydrocarbons (BTEX), including trimethylbenzene (TMB)
- Aliphatic total petroleum hydrocarbons (TPH)
- Trace amounts of polycyclic aromatic hydrocarbons (PAHs)
- Free- phase oil at one location

Other challenges at the site included:





- Deep contaminant impacts
- Site constraints: nearby plant buildings; underground tank and pipeline facilities; small stream downgradient of contamination (within 50 m)
- Unfavourable geology for conventional in situ remedial technologies
- Need for developing feasible site- specific remediation criteria
- Negotiated allocation of clean up costs among responsible parties
- Remedial costs

A technology was sought by the site owner and environmental consultant which could cost-effectively mitigate subsurface contamination within the site- specific constraints and limitations mentioned herein.

## **2.2 Geological and hydrogeological setting**

The area of investigation consists of a surface layer of concrete which is underlain by gravel and sand fill to a depth of 1,3 m below the ground surface (bgs). Underlying the fill soils are quarternary deposits of gravel and sand colluvium of variable thickness, interbedded with sand and clay layers. Silty clays are encountered below the colluviums between depths of 3,6 to 8,3 m bgs which forms a hydraulic boundary between the overlying quarternary colluvial aquifer and an underlying tertiary (drinking water) aquifer comprising fine to medium sands. The depth to groundwater ranges from 2 to 3 m bgs.

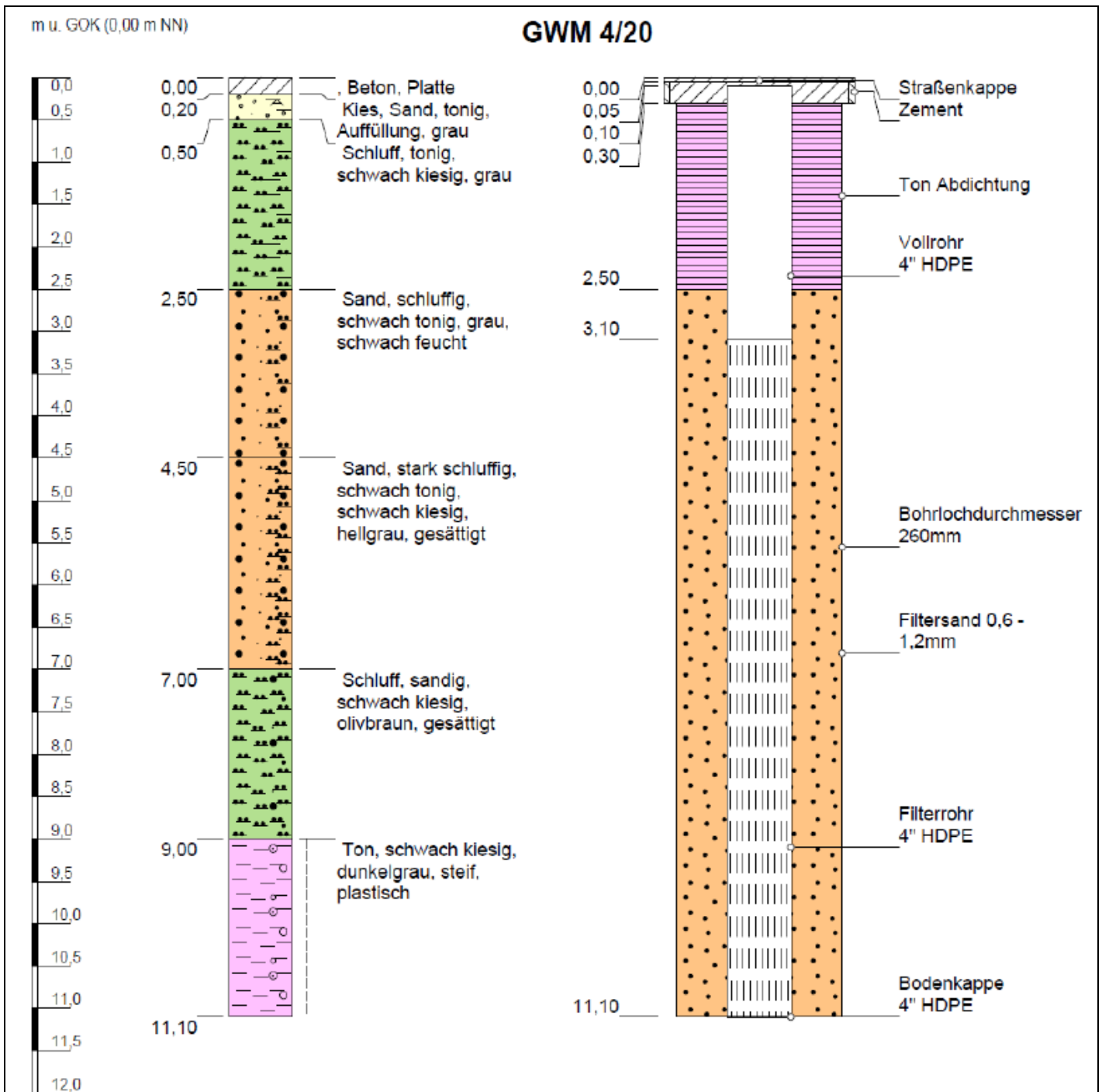

The results of pump testing conducted over 72 hours in the upper aquifer sediments determined an average hydraulic conductivity of  $1.3 \times 10^{-6}$  m/s indicating an aquifer of marginal yield (2L/min), due to the presence of significant silt and clay fines within the aquifer matrix. The direction of groundwater flow is to the south-southwest with a hydraulic gradient of approximately 5%.

## 2.3 Contaminants of concern



### Legende

Direct Push-Sondierung (DP)

- EC- und GW-Sondierung
- GW-Sondierung

n.n. nicht nachweisbar  
 -- keine Probenahme möglich

Gehalte LHKW in µg/l

- 0 - 100
- 101 - 500
- 501 - 1.000
- 1.001 - 10.000
- > 10.000



Distribution of CHC concentrations in Groundwater



A total of 6 subsurface investigations were conducted between 1999 and 2017 in an effort to delineate and quantify the distribution of contaminants underlying the site. The results of these investigations determined that petroleum hydrocarbon contamination (TPH and BTEX impacts) were largely confined within soils in the unsaturated zone with contaminant concentrations upwards to 5,000 mg/kg and 344 mg/kg respectively. Dissolved- phase contaminant impacts to groundwater within the quaternary aquifer consisted primarily of total chlorinated aliphatic hydrocarbons (CHCs) of upwards to 44,300 µg/L, followed by TPH (2,000 µg/L) and BTEX (1,800 µg/L).

The major component of CHC contamination was cis-1,2 DCE (54%), followed by tetrachlorethylene ("PCE" 28%), and trichloroethylene ("TCE" 16%). The major component of BTEX contamination was trimethylbenzene (TMB >76%) followed by xylenes.

Free-phase oil product was detected at one monitoring well location with an apparent thickness of a few cm.

Calculations to estimate the mass of contaminants present within the quaternary aquifer indicated a total of approximately 3.7 kg of dissolved phase CHCs and 8.7 kg of sorbed phase CHCs respectively. The estimated total of BTEX and TPH contaminants (dissolved and sorbed) was approximately 2.5 kg. Applicable groundwater regulatory limits for contaminants of concern found in groundwater at the site are summarized below:

- CHCs: 20 µg/L
- VC: 0.5 µg/L
- BTEX: 20 µg/L
- TMB: 1 µg/L
- TPHs: 100 µg/L

The delineation of the various contaminants of concern was achieved using a combination of soil probe borings, drilling and sampling of groundwater monitoring wells, and through the use of innovative Direct Push technologies using Geoprobe® drilling equipment and specialized sampling technology such as Membrane Interface Probe (MIP), Screen Point groundwater sampling, and Electrical Conductivity (EC) downhole tools.



## 2.4 Regulatory framework

Based upon the results of subsurface contamination quantified at the site, the regional environmental regulatory authority ordered that soil and groundwater remediation efforts be implemented at the site to mitigate contaminant impacts on potential environmental receptors. The specific goal of the regulatory clean up order was to “prevent the danger of contaminant exposure to receptors and prevent the long term spreading of contaminants”. In order to achieve this goal, the regulation requires that “applicable remedial measures be applied to minimize or remove contaminants (i.e decontamination) and to prevent or minimize the spread of contaminants i.e. (containment)”.

A Remediation Action Plan was subsequently requested by the authority to comply with the above mentioned regulatory requirements. The remedial plan submitted to the authority proposed remediation of the heavily impacted unsaturated zone soils by excavation and disposal, resulting in the removal of approximately 300 m<sup>3</sup> of contaminated soil to a depth of 2 m to 3m bgs. This remedial measure was implemented concurrently with the decommissioning and removal of the existing oil and chemical storage building on the property. There were no specific contaminant clean up criteria for soil quality required for the excavation of impacted surface soils.

For the remediation of dissolved phase contaminants in the unsaturated zone, a feasibility study for the implementation of in situ chemical oxidation (ISCO) and in situ bioremediation (ISBR) was proposed as possible cost-effective and sustainable remediation alternatives to conventional excavation/disposal and large diameter soil replacement borings that were being considered. The results of the study determined that ISCO was a viable approach, although its effectiveness for practical purposes could be severely limited based upon the low hydraulic conductivity of the saturated zone sediments. To overcome this limitation, the authority approved the application of “environmental fracturing” using Targeted Solids Emplacement (TSE<sup>®</sup>) technology by Sensatec GmbH as the preferred means of distributing solid-phase oxidants as slurry into the impacted aquifer sediments.

Risk-based remediation criteria were developed for CHC contaminants at the site whereby a reduction of total CHC concentrations (i.e for PCE, TCE, DCE and VC) of 95% over 3 consecutive monitoring events in source area monitoring wells was required.



## 3. Laboratory-scale application in field

### 3.1 Laboratory scale application

A laboratory feasibility study was conducted by Sensatec GmbH at its facilities in Kiel, Germany, to compare the efficacy of ISCO and aerobic/anaerobic ISBR to degrade concentrations of total CHC and BTEX contaminants in soil and groundwater samples obtained from the site.

The scope of the laboratory work consisted of:

ISCO:

- Characterization of ISCO relevant parameters TIC, TOC, metals, pH and EC;
- Determination of Soil Oxidant Demand;
- Determination of reaction kinetics and oxidant demand;

ISBR:

- Determination of site-specific micro-biological nutrient deficiencies and requirements (N,P,K,S,C);
- Conducting substrate induction tests to identify cosubstrate utilization profiles for various carbon based substrates at differing concentrations;
- Contaminant degradation testing using 5 varieties of substrates to enhance anaerobic and aerobic attenuation rates.

The results of laboratory analyses for ISCO determined that the impacted sediments contained very little natural organic matter ( $foc = < 0,001$ ) compared to inorganic carbon ( $0,0038$  g/g) due to high levels of oxidizable iron. The corresponding soil oxidant demand was determined by 96 hour batch testing to be  $14$  g oxidant/kg soil matrix which is classified as low oxidant demand (Oppermann, 2013), thereby indicating that ISCO was a viable remedial option for the site.

Of the three candidate oxidants considered in the laboratory feasibility analysis, potassium permanganate and activated persulfate oxidants showed the greatest destruction efficiency (contaminant mass removal/oxidant consumption) of CHC and BTEX contaminants compared to Fentons reagent, which exhibited the greatest oxidant consumption and shortest longevity (94% reduction within 48 hrs). The results demonstrated that Fentons Reagent was a less efficient oxidant compared to permanganate or persulfate (comparitive efficiency of 25%) due to its non-selective oxidation of metals and NOM, and fast kinetics, which result in the rapid depletion of oxidation potential and short remedial duration. Fentons reagent also exhibited the largest decrease in pH over the course of the test (from 7,1 to 2,7), whereas potassium permanganate exhibited the slightest decline (from 7,1 to 6,6) and returned to its pre-

test value after 96 hours.

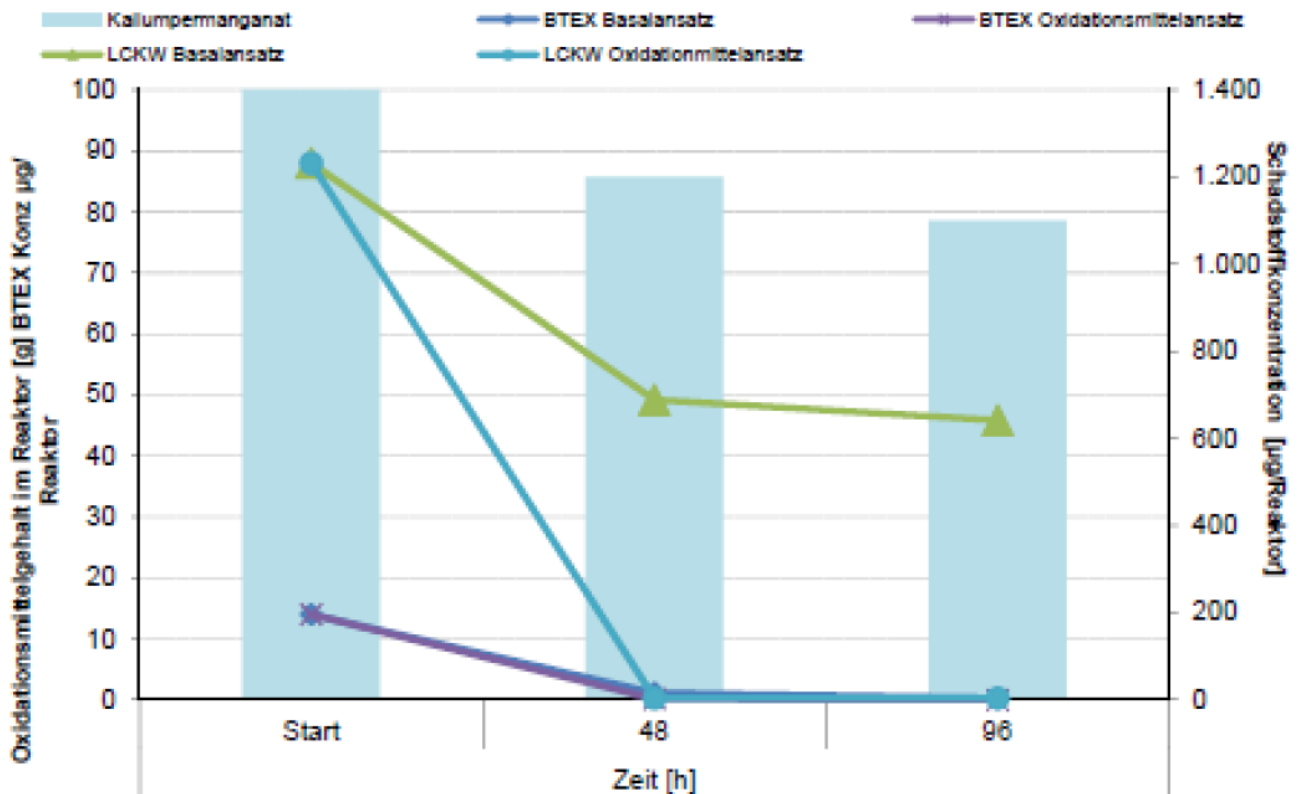

Oxidant consumption ( $\text{KMnO}_4$ ) and contaminant reduction (CHC and BTEX) during 96 hr reactor test

The results of laboratory analyses for ISBR determined that nutrient addition to site groundwater samples did not appreciably increase aerobic respiration rates, thereby indicating that there were no deficiencies of ambient NPKS nutrient concentrations existent at the site for aerobic biodegradation to take place. Investigations into the efficacy of aerobic and anaerobic cosubstrates (“cosubstrate screening”) were conducted to determine oxygen consumption and redox potential, respectively. This was done to assess the performance of 4 candidate aerobic cosubstrate and 5 anaerobic cosubstrates being considered. The results of cosubstrate screening indicated that two anaerobic substrates (molasses, vegetable oil) two aerobic substrates (hydrogen peroxide, methanol), and an untreated reference standard, be selected for further testing on contaminants to determine bioremediation performance over a period of 55 days. In addition, qPCR gene testing was carried out on the anaerobic substrates to assess whether the gene copy count of dehalogenase *bvcA* and dehalogenase *bvrA* enzymes increased in the presence of the substrate or not. The testing was carried out to investigate the relative biodegradation potential of each of the substrates for mitigating both total CHC concentrations and BTEX concentrations, the results of which are indicated in the graphics below.



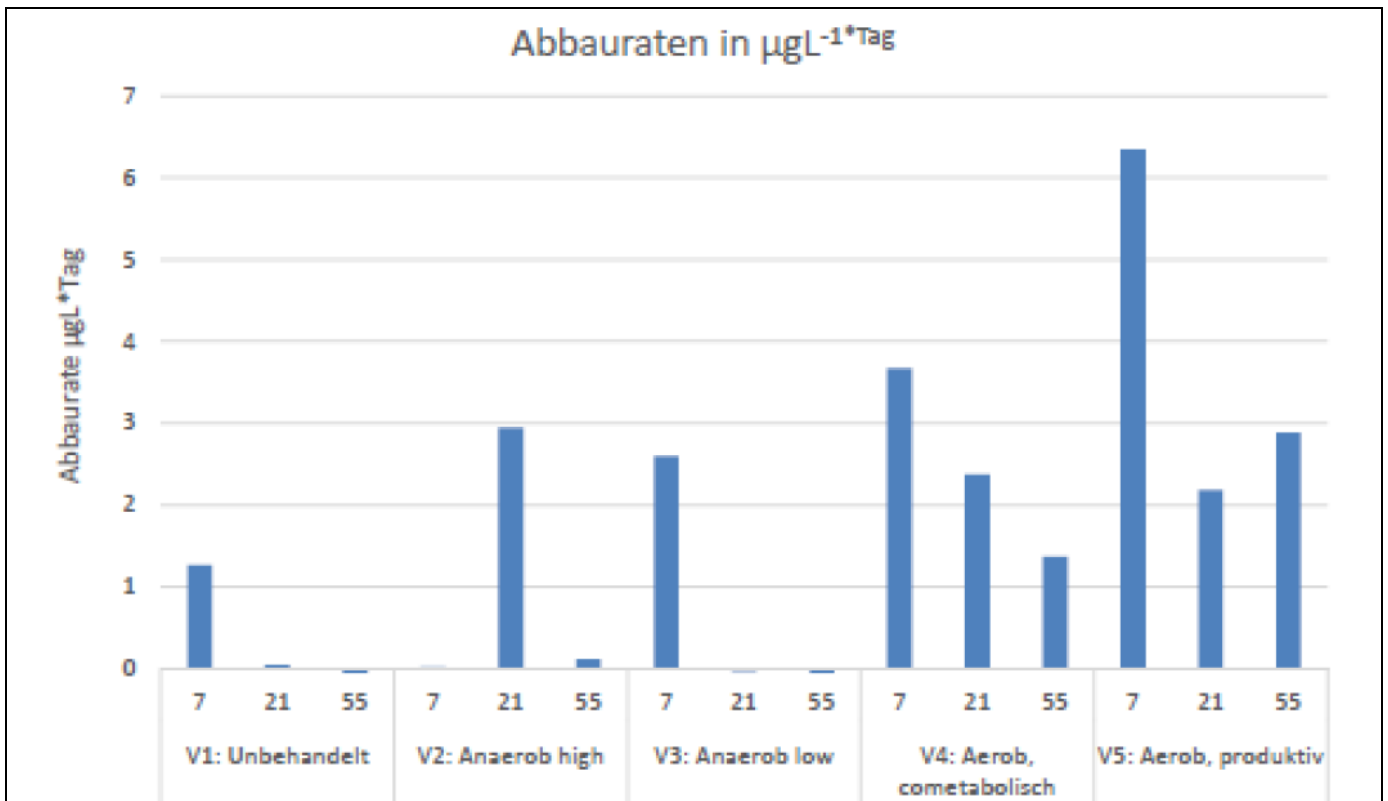

Degradation rates for total chlorinated aliphatic hydrocarbons (CHCs) using anaerobic and aerobic substrates

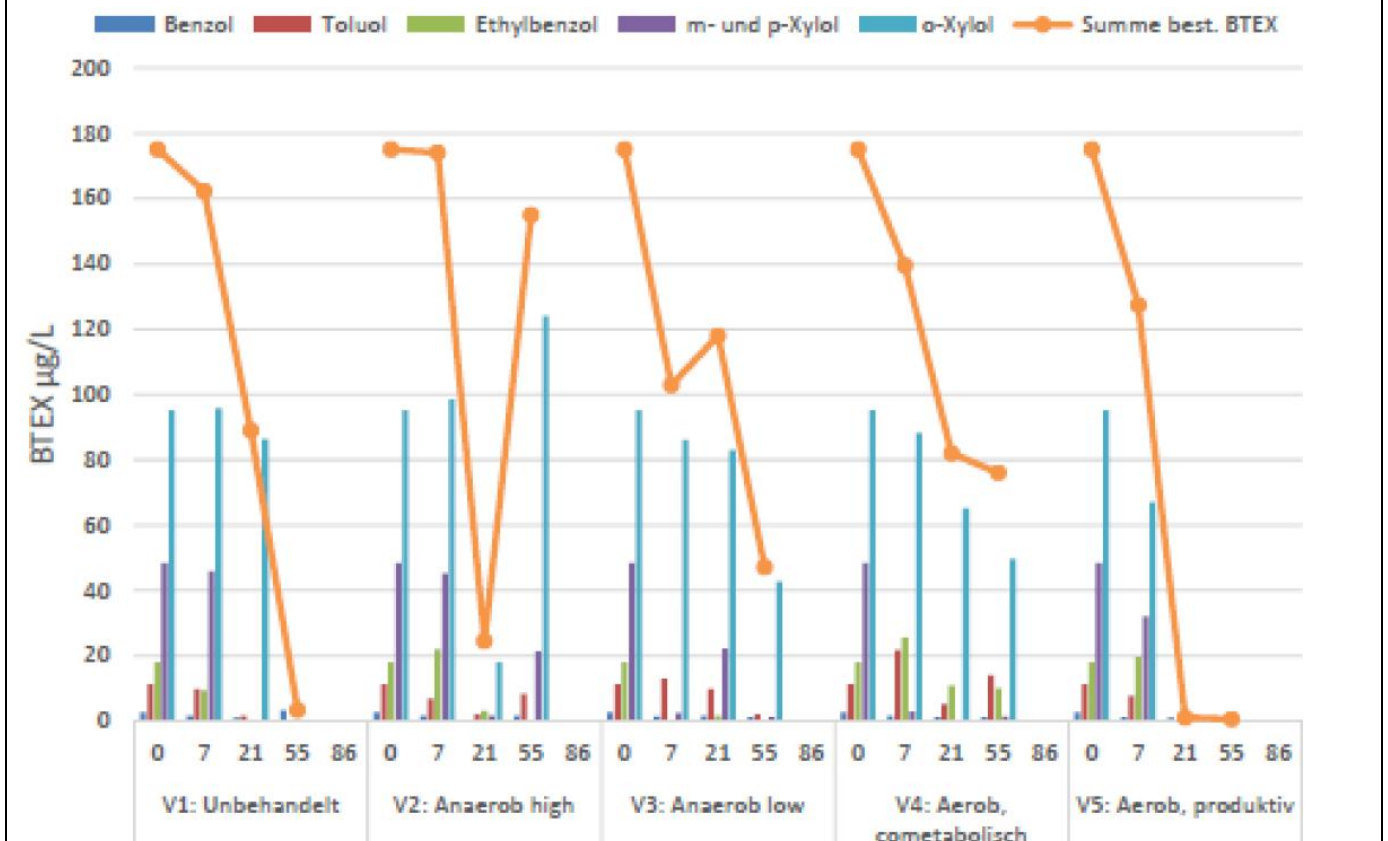





## Degradation rates for aromatic petroleum hydrocarbons (BTEX) using anaerobic and aerobic substrates

The conclusions derived from the laboratory feasibility study are summarized as follows:

- Elevated background respiration rate of 7 mg/L/day O<sub>2</sub> within aquifer samples are indicative of strongly aerobic conditions.
- The most effective cosubstrates for degrading CHCs and BTEX contaminants were molasses (anaerobic cosubstrate) and methanol (aerobic substrate) at a concentration of 1000 mg/L respectively.
- Low concentrations of dehalogenase enzymes ( $< 2 \times 10^3$ ) as measured by qPCR analysis suggests that ambient populations of dehalococcoidis within the aquifer may be inadequate to stimulate anaerobic dechlorination without additional bioaugmentation.
- The greatest biodegradation observed for CHCs and BTEX was by the aerobic process through the addition of oxygen (for this study, hydrogen peroxide).
- ISCO was recommended for the full scale remediation of the site for CHCs and BTEX



## 4. Pilot-scale application in field

### 4.1 Main treatment strategy

Based on the results of a comprehensive site-specific laboratory feasibility study to assess the efficacy of various in situ approaches (see previous section 3), and their demonstrated, long term experience in advanced ISCO applications in the field, neither the regulatory authority, environmental consultant, nor site owner expressed a need or desire for conducting a field pilot study.

## 5. Full-scale application

### 5.1 Main Reagent

The primary remediation strategy for the site-specific conditions (i.e. geology, contaminant situation, and hydrogeology) was to first conduct an ISCO treatment comprising:

- Targeted emplacement of an activated, dual- phase oxidant solids with significant treatment longevity (potassium persulfate activated by calcium peroxide);
- Construction of oxidant emplacement boreholes as injection wells;
- Monthly then quarterly groundwater sampling and analysis (“iterative feedback loop”);

“Secondary Treatment”, once indications that the primary oxidants were exhausted:

- Optimized reinjection of solution oxidants (sodium permanganate) into injection wells exhibiting contaminant rebound
- Continued groundwater monitoring (“iterative feedback loop”)

“Tertiary Treatment” follows in those remaining areas where contaminants persist:

- Enhanced aerobic bioremediation through slow release oxygen and nutrients

ISCO technology using solid phase oxidants emplaced by environmental fracturing (Targeted Solids Emplacement, “TSE<sup>®</sup>”) was selected due to its cost-effectiveness for treating multiple contaminants (chlorinated and petroleum hydrocarbons) present in low- permeability soils (silty sands and clay), its relatively non-disruptive implementation (direct push drilling) compared to ex situ methods considered, and due to its environmental sustainability (contaminant destruction vs. transfer).

Potassium persulfate was chosen as the primary oxidant due to its ability to form sulfate

radicals by alkaline activation through the addition of calcium peroxide (aktivator and secondary oxidant). The potassium form of persulfate also provides greater oxidant longevity due to its relatively low solubility. Calcium peroxide, in addition to activating persulfate, ensures a steady supply of slow-release oxygen into groundwater even after the persulfate oxidant has been exhausted.

The ISCO approach implemented at the site was designed to oxidize primarily CHCs with secondary consideration to BTEX contaminants, as these had been largely removed in a limited excavation of surface soils at the site. Persulfate is effective in oxidizing these contaminants and is less sensitive to SOD than other oxidants considered, and less hazardous to handle on site.

Environmental fracturing using Targeted Solids Emplacement (TSE®) coupled with Direct Push drilling was used as the preferred emplacement technology to ensure the distribution of high-solids oxidant slurry at selected depth intervals within contaminated soil zones of at least 6 m radius from injection boreholes. A total of 15 injection boreholes were used to emplace over 10.000 kg of persulfate-peroxide oxidants (dry mass) to depths of 10,5 m below ground surface (bgs). The mixing and fracture-emplacement of oxidants took place over 2 weeks followed by 3 weeks of injection well drilling, construction, and well development.



High pressure injection/fracturing/ and mixing equipment used for fracture-emplacement of persulfate-peroxide oxidant slurry into subsoils through direct push drill holes

## 5.2 Additives

The ISCO approach implemented at the site required that high- concentration oxidant slurry comprising low-solubility, solid based oxidants be emplaced into low permeability subsoils. This method of oxidant emplacement differs fundamentally from a simple injection of a solution based oxidant at low concentration which is normally the case (e.g. 4% potassium permanganate solution).

In order to ensure that solid based oxidants stay suspended in a water based slurry during pumping, and to avoid oxidants being “screened out” by fine grained aquifer sediments during emplacement into subsoils, a food-grade organic polymer gel was used to thicken the slurry to the required viscosity to ensure its placement at a concentration of upwards to 40% oxidant solids throughout its radius of distribution..

## 5.3 Injection type

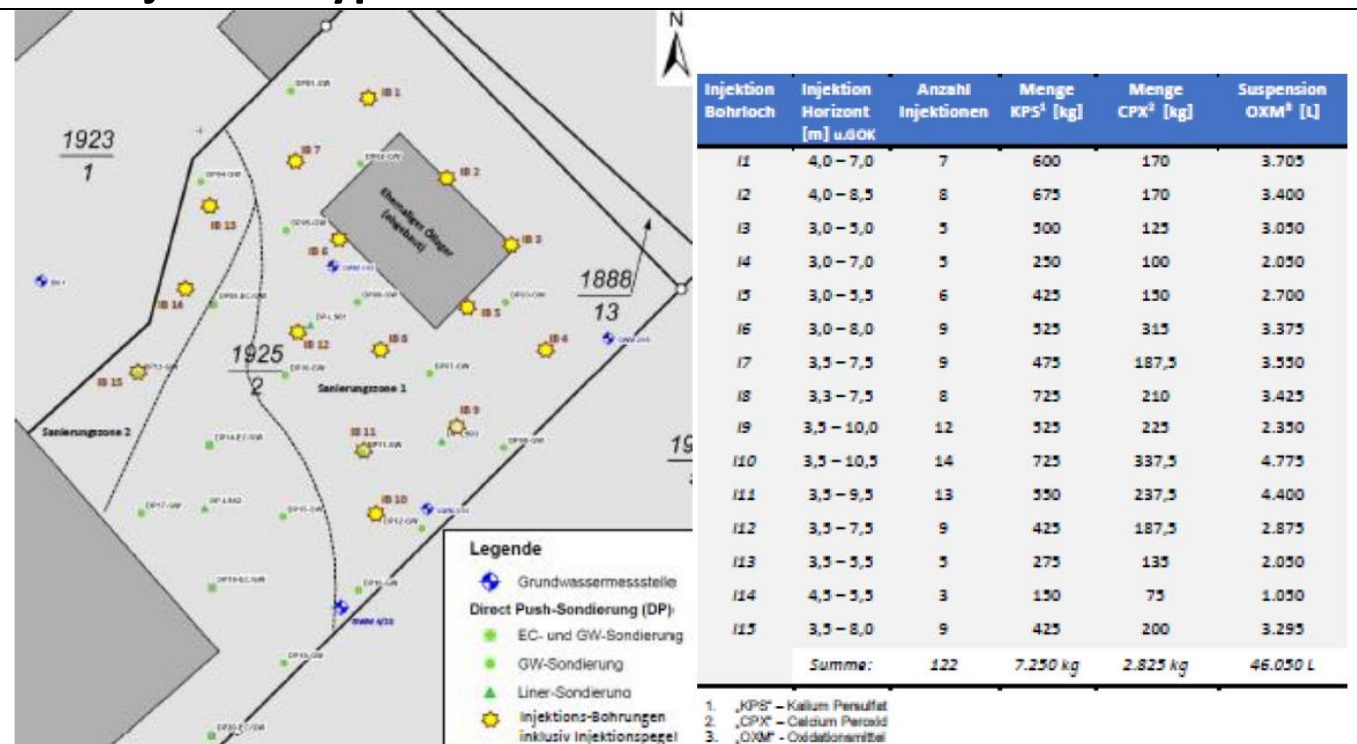

The fracture-emplacement of oxidant slurry using TSE® technology was achieved by advancing drill rods using Direct Push drilling equipment into subsoils to predetermined depths, followed by injection of slurry under hydraulic pressure using specialized high-pressure injection assemblies, and pumping and mixing equipment. The injections were conducted in a “top-down” approach, at 0,5 m depth intervals to the maximum depth of



impacts at each location. A total of 122 injections at 15 pre-determined locations within the contaminant plume was thus achieved (see site plan and table above).

Two of the injection boreholes were initiated in previous MIP investigation borings in order to minimize coring of the concrete surface. The spacing between borings was approximately 7 to 8 m which ensured overlapping oxidant distribution between injection points. All of the 15 injection boreholes were subsequently completed as 2" diameter (50 mm) injection wells for follow-up solution oxidant/biosubstrate treatment (where required), and for monitoring and sampling purposes.

All operational parameters were recorded during fracture-emplacement of oxidants (fracture and propagation pressures, flow rates, volume) including operational losses due to short-circuiting to ground surface (approx. 1% of the total volume injected). A typical injection profile is shown below.

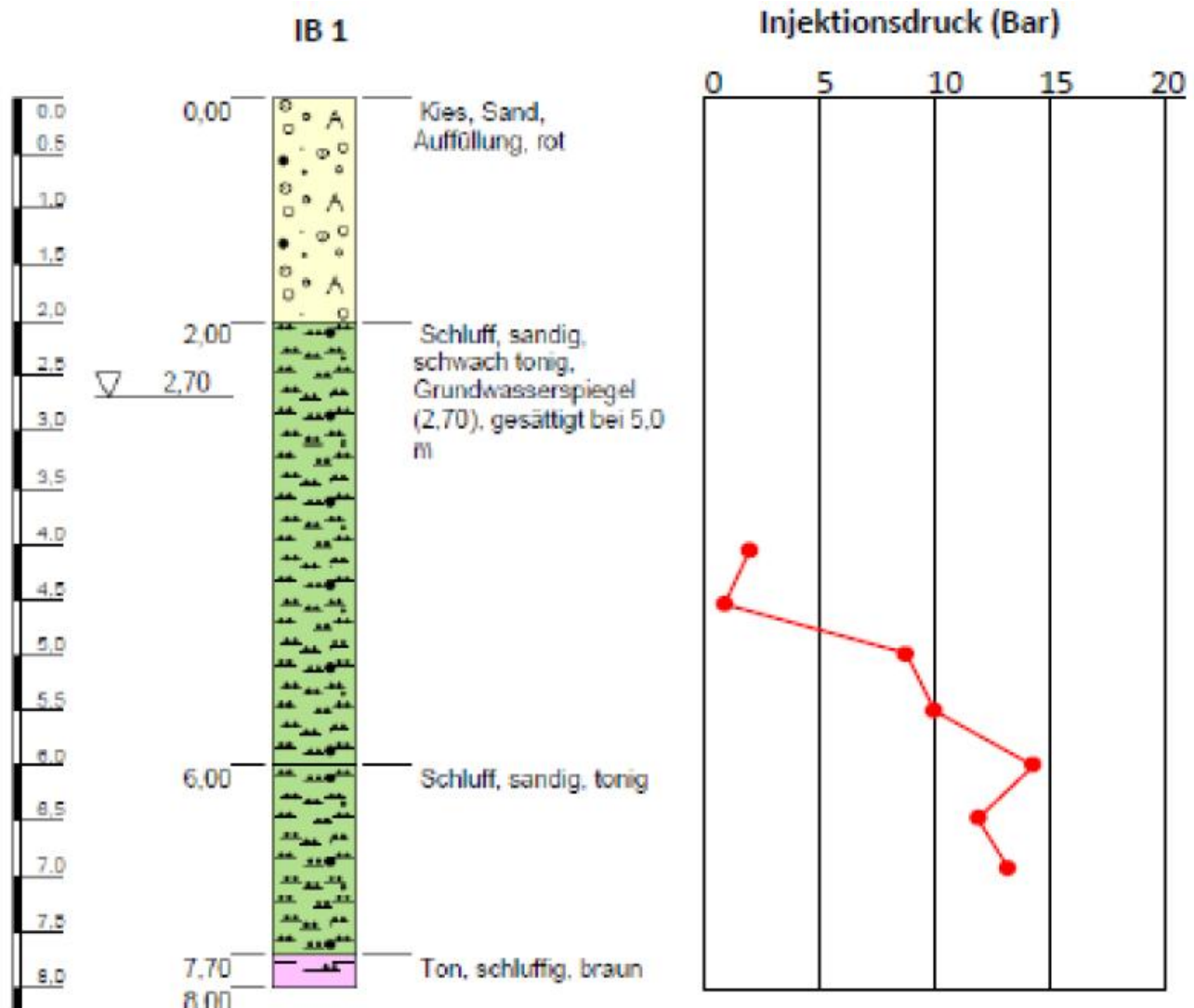

In this manner a total of 10,125 kg of oxidant (dry) mass was hydraulically emplaced throughout contaminated sediments as a slurry with total volume (including flush volumes) of approximately 46 m<sup>3</sup>.



## 5.4 Radius of influence

The determination of a “radius of influence” for the introduction of fluids into subsurface soils is seldom more than a theoretical calculation, as the actual “radius” of distribution is highly variable, even within a single injection point, as it is governed by soil heterogeneities (variable porosity, permeability, fines content), hydrogeological pressure gradients, and geotechnical/geotechnical properties of the subsurface (soil density, cohesion, plasticity, structure and fabric, and in situ stress conditions) see discussion in Section 7.2

In the case of the subject site, a theoretical radius of oxidant distribution of 3,5 m was used for the injection work at the site, although field observations indicated that the extent of oxidant distribution was upwards to 6 m at some locations.

## 5.5 Process and performance monitoring

Performance monitoring of control parameters to assess the effectiveness of ISCO remediation need to be tailored to the specific chemical characteristics of oxidants being applied, and the physical, geochemical, and microbiological parameters in groundwater. Important field parameters that were included in the post application monitoring comprised pH, electrical conductivity, redox potential, temperature and dissolved oxygen. Monitoring of pH is especially important in order to assess the buffering capacity of the soils and the potential of metals mobilization. Oxidant specific parameters included sulfate, dissolved and potassium (indicators of the primary oxidant, dissolved oxygen, potassium persulfate), as well as calcium, alkalinity, and dissolved oxygen (indicators of the secondary oxidant, calcium peroxide). Monitoring of the component cations in groundwater serve as an indicator as to the extent of distribution and relative concentration of oxidants present within the groundwater contaminant plume. Monitoring of contaminants included BTEX, CHCs (PCE, TCE, DCE, VC) was conducted, as were reaction products methane and carbon dioxide. Also included were analyses of metals.

Groundwater monitoring campaigns were carried out on a monthly basis for the first three months after oxidant emplacement and bi-monthly thereafter. Monitoring data and groundwater laboratory analytical have been collected over a span of 10 months so far.

## 6. Post treatment and/or Long Term Monitoring

### 6.1 Post treatment and/or Long Term Monitoring

Initial field parameter measurements taken within a month of oxidant emplacement within the contaminant plume area showed strong evidence of oxidation taking place, as indicated by elevated redox (electron activity) conditions ranging from 250 to > 600 mv, and dissolved oxygen levels ranging from 10 to > 40 mg/l

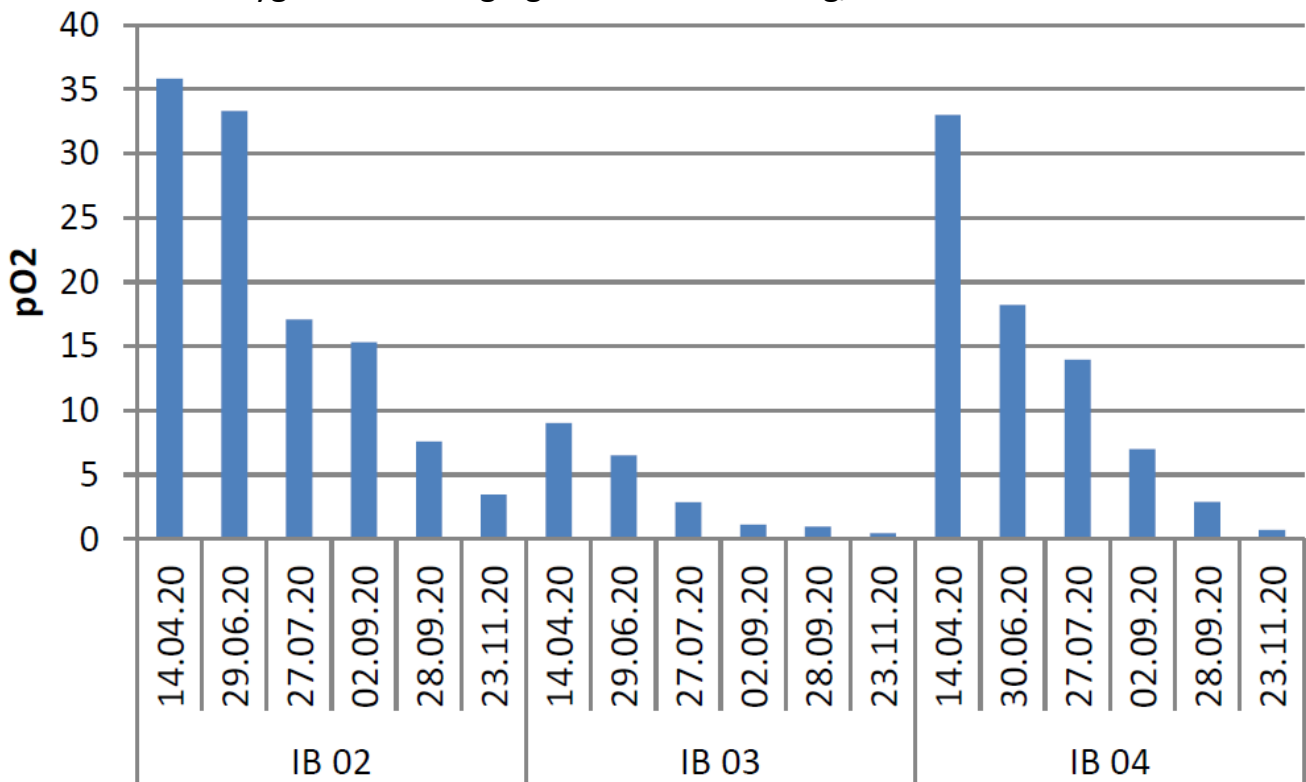

Typical oxygen depletion profile in plume area wells after injection

An assessment of oxidant longevity and contaminant persistence was made based on the decreasing concentrations of BTEX and CHCs in groundwater and the relative magnitude of contaminant rebound (where present) in the injection and monitoring wells over the monitoring period (10 months). The results indicated that of the 15 wells completed within the contaminant plume area:

- 1 well showed no contaminant rebound
- 6 wells showed moderate rebound effects (< 25 % of pre-treatment concentrations)
- 8 wells showed strong rebound effects (> 50 % of pre-treatment concentrations)

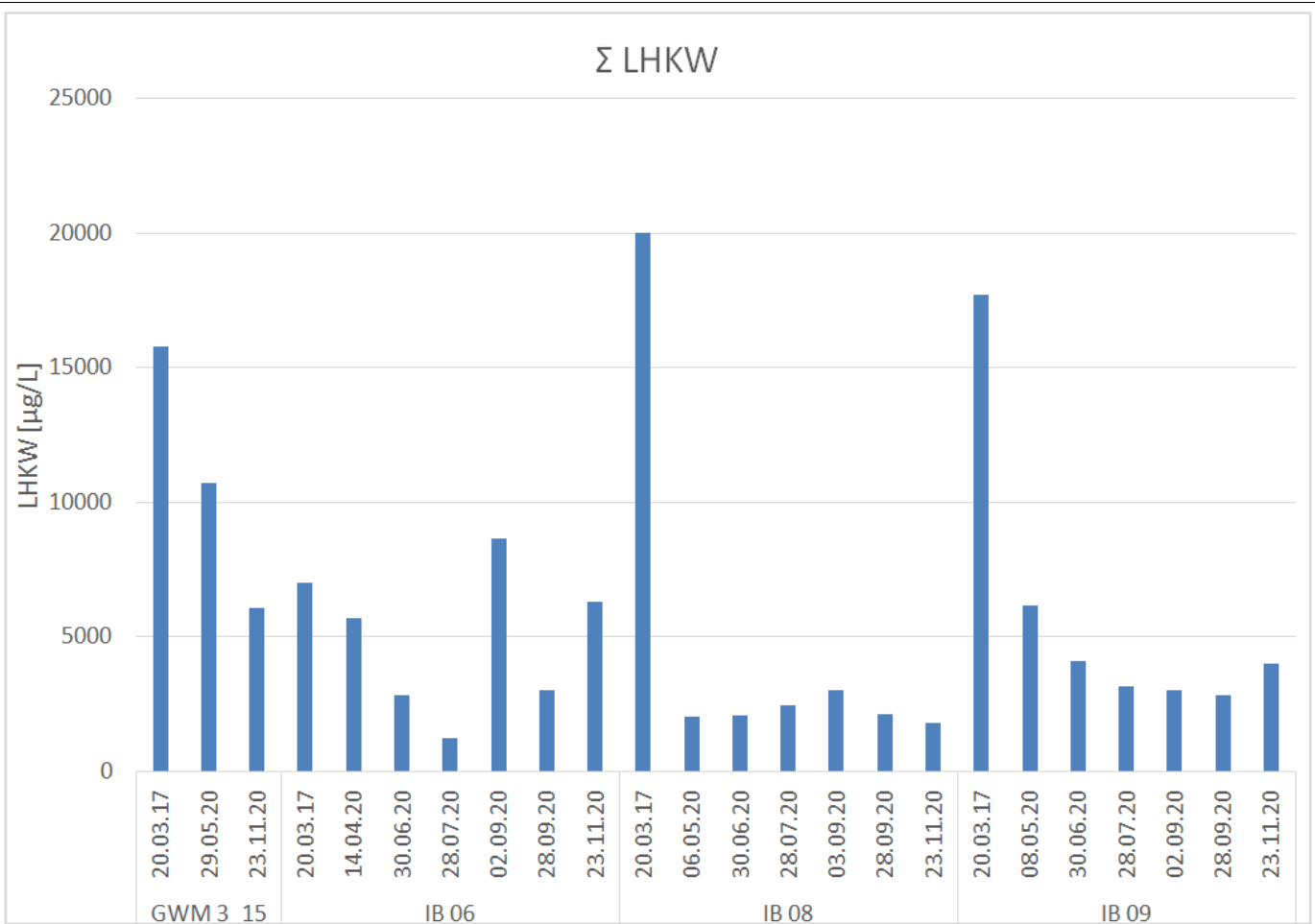

Typical CHC concentration profiles for: perimeter groundwater monitoring well GWM3\_15; plume area wells IB05 (with rebound); plume area well IB07 (no rebound) after oxidant injection.

The collective assessment of field parameters such as redox and dissolved oxygen with geochemical parameters (e.g. sulfate) and contaminant concentration over time suggests that a longevity of approximately 4 to 5 months was achieved with the primary oxidant (persulfate), and a continuation of milder direct oxidation processes with oxygen (slow-release peroxide) from the secondary oxidant for a few months longer.

Based on this initial phase of performance monitoring in the “iterative feedback loop” approach, a second round of oxidant injection is planned in 2021 for those wells exhibiting rebound effects. This process is continued until concentrations have reached a low enough concentration whereby microbial amendments can be effectively applied to “polish” the remaining residual and trace concentrations of contaminants to reach remedial goals.





## 7. Additional information

### 7.1 Lesson learnt

The subject site presented many challenges to an effective ISCO strategy, due to:

- Uncertainty as to origin of some contaminants (possibly off-site?)
- Extremely high concentrations of co-mingled and mixed chlorinated and petroleum hydrocarbon contaminants
- Low permeability of aquifer sediments
- Enforcement order to remediate
- Cost sensitivity
- Need for decommissioning of former building and shallow excavation of contaminants prior to in situ remedial work
- Presence of underground facilities (storage tank, pipeline)
- Nearby stream adjoining property
- Active business operations on property

Before an ISCO plan was even considered, the property was subject to high resolution characterization (Direct Push MIP and EC investigation) in order to better delineate the lateral and vertical extent of contaminants to allow a better estimation of contaminant mass in the subsurface. This was done in conjunction with pump testing and soil vapour extraction trials which determined that pump and treat and vacuum extraction were not feasible remedial methods for the site geology.

These data formed the basis of a laboratory feasibility study to assess applicable in situ oxidation and bioremediation options, which determined that ISCO was the preferable option in the initial stage of treatment.

The key to an effective ISCO treatment was to determine:

- Effective oxidation product(s) for treating both CHC and BTEX contaminants;
- Oxidant dosing rates which could be applied in the field for the various magnitude of contamination present across the site;
- Likely Mode of Distribution of oxidants (soil permeation or fractures) and best suitable drilling method for injection (auger, sonic, Direct Push, manchette wells with packer, open hole packers, etc)
- Optimization techniques in the field to minimize loss of oxidants to the ground surface through existing boreholes, underground structures, and backfilled soils
- Applicable monitoring parameters and frequency of monitoring/sampling
- Determination of plan and timing for follow-up injection treatment

Despite careful planning of the design based on the above criteria, problems arose in the field related to short circuiting (loss of oxidant slurry) to surface through backfilled soils



after recent excavation activities, and though old investigative boreholes not adequately sealed.

Attempts were made at an operational level to mitigate such losses by increasing fluid viscosity, and oxidant slurry density, while reducing total injection volumes to mitigate the surfacing of oxidants at certain injection locations. Oxidant slurry coming to surface was collected and stored in IBCs for subsequent injection at other borehole depths or locations.

Fracture-emplacment was the dominant mode of distribution of dual stage oxidants (slurrified potassium persulfate and calcium peroxide, supplied by *PeroxyChem*) which proved effective over a period of at least 5 to 6 months. “Iterative Feedback Loop” monitoring of post-injection groundwater quality was effective in determining those locations within the contaminant plume where, and to what extent, follow up injections (oxidants or bioamendments) are required. This example of a staged, treatment train approach to in situ remediation optimizes the resources (time and material costs) related to achieving site-specific remedial objectives at site without disruption to ongoing business operations.

## 7.2 Additional information

The determination of a “radius of influence” for the introduction of fluids into subsurface soils is seldom more than a theoretical calculation, as the actual “radius” of distribution is highly variable, even within a single injection point, as it is governed by soil heterogeneities (variable porosity, permeability, fines content), hydrogeological pressure gradients, and geotechnical/geomechanical properties of the subsurface (soil density, cohesion, plasticity, structure and fabric, and in situ stress conditions).

In fact the “radius” of distribution for liquid and solid treatment amendments is in most cases not a radius at all, rather a measure of the general extent of oxidant distribution from the point of injection. The distribution can be elliptical, off-center, or asymmetrical for example. This is due to the fact that distribution is a function of the inherent properties of injected amendments (viscosity, temperature, pH, polarity, particle size, ionic properties, precipitation, etc.) as it relates to soil properties. Therefore, a fundamental consideration in the estimation of the effective lateral Extent of Amendment Distribution (EAD) to a site is an assessment of the likely Mode of Distribution that is to be expected, based on the physical and chemical characteristics of the treatment amendment to be injected in relation to the soil characteristics (primarily porosity and permeability) being injected into. This is extremely important, as it is the mode of amendment distribution which will govern the actual extent of subsurface distribution for any given amendment



into soil or even bedrock, and can vary significantly. Therefore, the likely mode of distribution must be recognized in any remedial design involving the introduction of treatment amendments into subsoils.

Empirical evidence for the Mode of Distribution of liquid and solid phase chemical and biological treatment amendments in various geology over two decades of project work at sites across North America, Europe, and Asia was summarized by Bures (2009) as follows:

## Injection of Amendments: Mode of Distribution is important!

Infiltration if:  $D_p < \sqrt{K_f/7}$     or ...    Induced Pathways (FRAC) if:  $D_p > \sqrt{K_f/7}$   
Harris and Odem, 1982 (Dp: Particle Diameter in microns, Kf in millidarcys)

COMMON AMENDMENTS EMPLACED	MODE OF AMENDMENT EMPLACEMENT INTO SOILS AND BEDROCK (with respect to Hydraulic Conductivity)									
	>10 <sup>-3</sup> m/s	10 <sup>-3</sup>	to	10 <sup>-5</sup>	<10 <sup>-5</sup>	<10 <sup>-6</sup>	<10 <sup>-7</sup>	<10 <sup>-8</sup>	<10 <sup>-8</sup>	<10 <sup>-6</sup> m/s
	Gravel	coarse Sand	medium	fine	silty Sand	Silt	silty Clay	Clay	Competent Bedrock	Fractured Bedrock
Silica Sand (Proppant)	INF	FRAC	FRAC	FRAC	FRAC	FRAC	FRAC	FRAC	FRAC	FRAC
Coarse Zero Valent Iron	INF	FRAC	FRAC	FRAC	FRAC	FRAC	FRAC	FRAC	FRAC	FRAC
Micro- Iron	INF	INF	INF/FRAC	INF/FRAC	FRAC	FRAC	FRAC	FRAC	FRAC	INF/FRAC
Oxidant Solids (as slurry)	INF	INF	INF	INF/FRAC	FRAC	FRAC	FRAC	FRAC	FRAC	INF/FRAC
Oxidant Liquids (In solution)	INF	INF	INF	INF	INF	INF/FRAC	FRAC	FRAC	FRAC	INF
Solution Bio-Amendments (Lactates, Vegetable Oils)	INF	INF	INF	INF	INF	INF/FRAC	FRAC	FRAC	FRAC	INF
Viscous Bio-Amendments (Molasses, Whey, etc.)	INF	INF	INF	INF	INF/FRAC	FRAC	FRAC	FRAC	FRAC	INF
Solid Bio-Amendments (Cellulose, Chitin)	INF	INF/FRAC	FRAC	FRAC	FRAC	FRAC	FRAC	FRAC	FRAC	INF/FRAC

INF = Infiltration and permeation through pore space is the primary mode of amendment emplacement.

FRAC = Targeted Solids Emplacement (creation of a network of permeable treatment Pathways) is the primary mode of amendment emplacement.

In general, the mode of distribution of a liquid or solid treatment amendment in subsoils and bedrock can be estimated by a comparison of the particle size of the material to be injected to the pore throat diameter of the receiving geology, which can be defined as the square root of: formation permeability, Kf, divided by seven (Harris and Odem, 1982). For treatment amendments where the particle size is smaller than the pore throat diameter, the mode of amendment distribution is by pore space permeation (blue area above). If



the amendment particle size is smaller than the available pore throat diameter, then the mode of distribution is through the formation of a fracture, defined by its thickness, width, length, orientation, and inclination to the ground surface (green area above).

Even for liquid amendments where the receiving geology has tiny pore space measured in angstroms, (e.g. clays), the mode of amendment distribution will trend towards a fracture, since even moderate injection rates cannot be accommodated by low effective porosity soils, resulting in a tensile failure of the soil and the creation of a fracture.

There can also be instances where the amendment being emplaced into the subsurface exhibits characteristics of both infiltration through pore space by permeation and the formation of a fracture. These are so called “hybrid” fractures, that is, fractures with significant “leak off” into surrounding soil pores.

Why is this important? Because the mode of emplacement has a significant bearing on the radius of influence and the transport processes for contaminant distribution via injection techniques in subsoils. For example, even the injection of solution based, liquid amendments (oxidants or bioamendments) will result in the formation of fractures or hybrid fractures in soils with hydraulic conductivities of  $< 1 \times 10^{-6}$  m/s. For any given volume of solution amendment injected, therefore, the observed “radius of influence” will appear to be much greater than what would normally be expected if this calculation were based on the assumption of permeation. A volume of 1000 L of liquid amendment injected into a soil with an effective porosity of 10 % will correspond to a theoretical radius of influence of roughly 1,8 m per m of well screen if permeation through pore space were assumed, but the same volume would result in an theoretical fracture radius of 8 m (!!) if soil permeability is insufficient to allow radial porous flow. Therefore it would be prudent to know what the predominant mode of distribution to be expected at a site is, before implementing a full scale remedial design using “radius of influence” calculations, and hence injection well spacing, that are possibly based on faulty premises.

An equally important consideration in the importance of understanding the mode of distribution is the contact mechanism of injected amendments with respect to contaminants. Injection by radial permeation through the pore space in soils with relatively high permeability results in advective and dispersive mixing with dissolved phase contaminants. In contrast, the mechanism of contaminant treatment via emplacement of treatment amendments by fracturing, which by implication means in fine grained soils, is primarily through pressure induced penetration into soils at the fracture face, chemical gradient, and diffusion of oxidants from fractures into soil mass between individual fractures (see below).



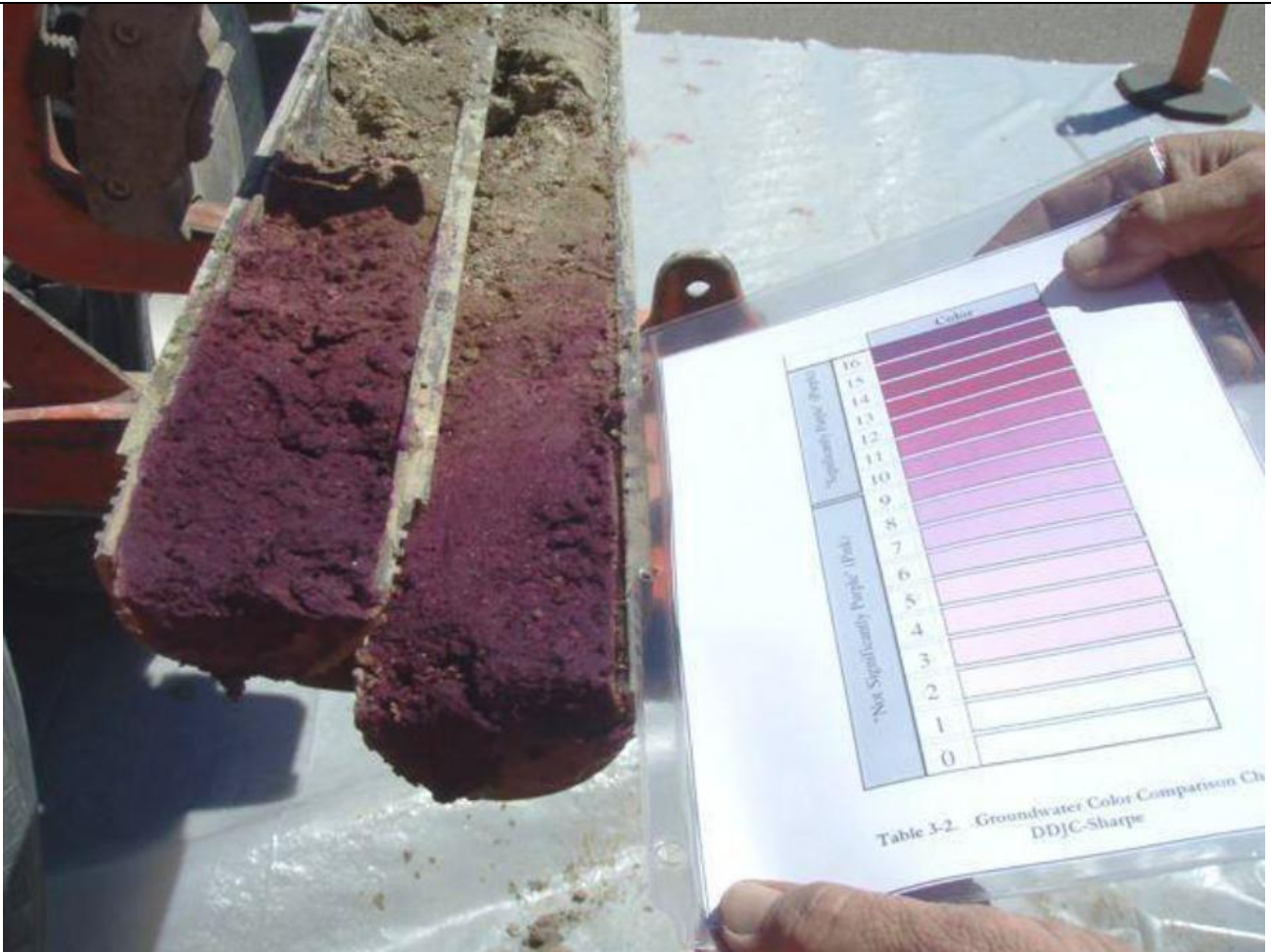

Example of oxidant diffusion profiling in silt soil cores 90 days after fracture-emplacment of potassium permanganate oxidant slurry (bottom of core) Photo courtesy of URS, 2006 – Bures archive

### 7.3 Training need

Effective in situ remediation using oxidants requires a multi-disciplinary approach across a wide spectrum of scientific and engineering know-how. The end effect means that remedial design, and particularly the practical application of ISCO can be complicated, as it requires specialized knowledge in:

- Geology
- Groundwater hydraulics
- Organic and inorganic chemistry
- Biochemistry
- Polymer chemistry
- Fluid mechanics



- Soil / Rock mechanics
- Drilling technology
- Injection technology
- Mixing and pumping technology
- Tracer and geophysical mapping technology
- Risk assessment
- Knowledge of regulatory requirements

It become obvious that based on the comprehensive suite of expertise required above, that the effective application of ISCO is very much a team effort. Although much of the expertise listed above are standard fields of study at universities or technical colleges, there is simply no substitute for experience gathered on actual project applications. Therefore, academic and industry workshops, conferences, technology specific webinars, and shared practical experience are of significant importance for anyone wishing to be a competent practitioner in this field.

## 7.4 Additional remarks

Any meaningful discussion of in situ chemical oxidation (ISCO) is incomplete without an understanding of the Mode of Distribution of oxidants being introduced into the subsurface environment and Contact Optimization with contaminants residing there. These considerations are essential elements for achieving remedial success using an ISCO approach, yet tend to be poorly understood by many working in this field. Fortunately, there exist a variety of innovative remedial enhancement and remedial performance monitoring technologies to rectify these shortcomings, among others:

- Dual– or multiple component oxidant formulations with a variety of activation mechanisms to achieve the highest oxidation potentials for oxidizing even mixed or co-mingled subsurface contaminants (e.g. CHCs and TPH) over long periods
- Incorporation of environmentally benign surfactant technology into the ISCO process to improve the performance oxidants by improving contaminant availability and oxidant penetration into pore spaces
- Specialized mixing, pumping, and rapid delivery technologies that enable precise and targeted emplacement of high concentration oxidant solids (as slurry) into permeable as well as impermeable sediments, including bedrock (e.g. TSE<sup>®</sup> technology with Direct Push drilling), or the emplacement of permeable pathways (e.g. sand fractures) in low permeability soils which can then be repeatedly injected with oxidant solutions.
- Employing the use of non-intrusive and robust geophysical techniques to map

subsurface distribution of liquid or solid oxidants from their point of delivery either as radial permeation, fracture propagation, or hybrid distribution in subsurface sediments (e.g. SensaTrax® tiltmeter geophysics):

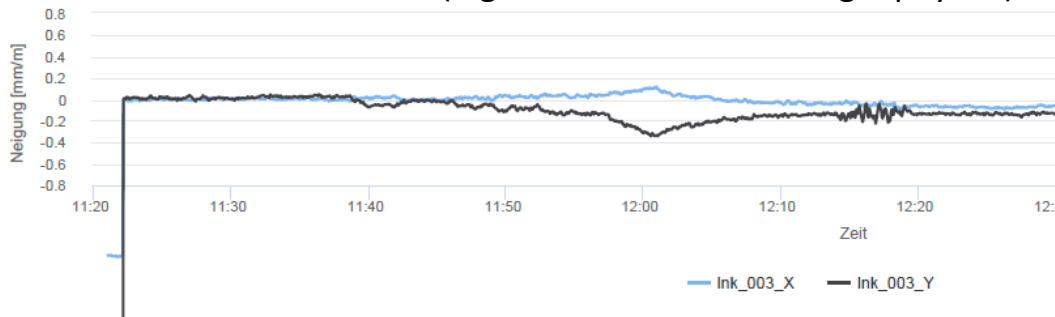

Furthermore, ISCO as a remedial application should not necessarily be viewed as the sole approach to site remediation, as by itself it rarely achieves every remedial target goals for every contaminant at every site. Rather it should be seen as part of a Treatment Train approach whereby oxidation can, at an appropriate point in the remedial process, be transitioned into a more passive bioremediation approach (aerobic or anaerobic Engineered Natural Attenuation, “ENA”) to mitigate remaining contaminants to their remedial endpoints.

## Glossary of Terms

Term (alphabetical order)	Definition
BTEX	Benzene, Toluene, Ethylbenzene, Xylenes
CHC	Chlorinated aliphatic hydrocarbons
TPH	Total petroleum hydrocarbons
DCE	Dichlorethylene
EAD	Lateral, effective Extent of Amendment Distribution
ENA	Engineered natural attenuation
IFL	Iterative Feedback Loop
ISCO	In situ chemical oxidation
ISBR	In situ biological remediation
MIP	Membrane interface probe (high resolution characterization of contaminants)
PAH	Polycyclic aromatic hydrocarbons
PCE	Tetrachlorethylene
SOD	Soil Oxidant Demand
TCE	Trichloroethylene
TMB	Trimethylbenzene
TSE®	Targeted Solids Emplacement (by Sensatec GmbH)
VC	Vinyl chloride



## 1. Contact details - CASE STUDY: ISCO n.7

<b>1.1 Name and Surname</b>	Hadas Sharon
<b>1.2 Country/Jurisdiction</b>	Israel
<b>1.3 Organisation</b>	Ludan environmental technologies
<b>1.4 Position</b>	Environmental engineer
<b>1.5 Duties</b>	Project manager
<b>1.6 Email address</b>	<a href="mailto:hsharon@ludan.co.il">hsharon@ludan.co.il</a>
<b>1.7 Phone number</b>	+972 52-511-2139



## 2. Site background

### 2.1 History of the site: Challenges and Solution

- Background- In an industrial area in Israel contamination from solvents was found in groundwater from the site. Apparently due to the industrial activity of some factories from the 1950s.
- The remediation was performed as part of a change in the site designation from industrial activity to commercial activity.
- Characteristics of the contamination - In investigations performed on the site over the years, high concentrations of chlorinated solvents were found, the main one was trichloroethylene (TCE).
- The goal- reduction of the concentrations of chlorinated carbon in the groundwater, in a total area of about 300 square meters. The reduction was examined by comparing the target values as agreed with the Water Authority.
- The selected rehabilitation technology- An alternative survey was prepared for the remediation of the site. Following its findings, it was decided to treat the groundwater by injecting a chemical oxygen (potassium permanganate  $\text{KMnO}_4$ ).
- The main challenge in performing the remediation - during the remediation period, construction work was performed to establish a new tower and an underground parking in the site, therefore safety measures had to be taken so that the combination of installing the foundations of the tower during the remediation period would be possible.

### 2.2 Geological and hydrogeological setting

- The soil at the site is sandy.
- The depth of the groundwater at the site, approximately 20 m below the ground.

### 2.3 Contaminants of concern

The results of the groundwater sampling show that the contaminants whose concentration exceeded the threshold values are trichloroethylene, manganese and chromium.



## 2.4 Regulatory framework

- In Israel, water remediation is in the responsibility of a government ministry - the Water Authority.
- The remediation plan and remediation reports are reviewed and approved by this authority.
- The following is a list of the target values of the contaminants, as approved by the Water Authority:
  1. Tetrachlorethylene - 187 µg/L
  2. Trichloroethylene - 374 µg/L
  3. 1,1-dichloroethylene - 187 µg/L
  4. cis-1,2-dichloroethylene - 935 µg/L
  5. trans1,2-dichloroethylene - 935 µg/L
  6. Vinyl Chloride - 9 µg/L

## 3. Laboratory-scale application in field

### 3.1 Laboratory scale application

Performing preliminary actions included:

- TOD test - as part of the installation of the injection wells, soil samples were taken to perform tests for the "natural oxygen demand" of the soil. Based on the results, precise calculations of the amount of oxygen and solution volumes required for the treatment of the contaminant on the site were performed.
- Pilot test - This test included injecting water in small volumes in order to examine injection rates, pressures and flow rates in the various wells before performing the oxidizing injections.



## 4. Pilot-scale application in field

### 4.1 Main treatment strategy

- The work includes three main stages:
  - **Stage A** - performing a preliminary pilot - checking flow rates and pressures
  - performing tests in the field and in the laboratory to determine the injection parameters.
  - **Stage B** - Perform the complete remediation by performing the injection.
  - **Stage C** - Concluding monitoring of groundwater to examine compliance with remediation, in accordance with target values of the contaminants.
- This remediation technology was chosen after examining all the remediation options.
- Considering the characteristics of the site and the fact that during the remediation period construction on the site was being carried out at the same time, it was decided to apply this technology.
- The challenge in this project was to enable the construction work and the construction of the underground parking at the same time as the groundwater treatment at the site.
- The oxidation injection was performed through 8 double injection wells to a depth:
  - Shallow: 0–3 m below groundwater level. Deep: 3.5–8 m below groundwater level.
  - The injections were performed for 3 days during which approximately 93,300 liters of permanganate solution were injected at concentrations of 0.5% to 2%, which included 1,025 kg of potassium permanganate.
  - At the end of the injections, air was injected for about three weeks to disperse the oxidants in the horizontal dimension so as to increase the distribution of oxygen in the aquifer.
- In order to monitor the remediation process, every six months groundwater monitoring and sampling was carried out for laboratory analysis of contaminants and geochemical parameters.



### 4.3 Injection type

- The layout of the wells at the center was designed according to the treatment area, the depth of contaminant concentration, the oxidizing properties and the soil properties.
- The permanganate solution, similar to the TCE substance, has a higher density than water and therefore, by its nature, "sinks" downwards. Therefore, the layout of the wells in the vertical axis was designed so that the effect of the treatment by the injected solution would cover the entire incision, up to a depth of 8 meters below groundwater level.
- The injections were performed for 3 days during which, approximately 93,300 liters of permanganate solution were injected at concentrations of 0.5% to 2%, which included 1,025 kg of potassium permanganate.

### 4.4 Radius of influence

- The radius of impact was defined as 4m in the horizontal dimension in accordance with experience from other sites with similar characteristics and in accordance with preliminary tests that included injecting water in limited volumes to test injection rates, pressures and flow rates in the various wells before performing the oxidation injections.



## 4.5 Control parameters

Field monitoring and sampling program that will adequately monitor both the dispersion of the oxidant and the effectiveness of the treatment in three dimensions are required. Usually measurements concerning oxidant dispersion are conducted more frequently than COC analysis and are completely different if the oxidant is in liquid or gas form.

- Below is the sampling frequency of the monitoring wells:
  - Before the injection
  - A month and a half after the injection
  - Three months after injection
  - Nine months after the date of injection
  - One year after the date of injection
- The following are the parameters tested in the groundwater sampling:
  - VOC
  - TDS
  - Metals
  - Alkalinity
  - Bicarbonate
  - Nitrite
  - Main ions
- The following are the field findings examined in the groundwater sampling:
  - ORP
  - EC
  - pH
  - OD



## 5. Full-scale application

### 5.1 Main Reagent

- Potassium Magnet ( $\text{KMnO}_4$ ) - Permanganate in aqueous solution exists in the form of anion ( $\text{MnO}_4^-$ ), as an oxidizer with high oxidizing power to organic hydrocarbons in general and chlorinated hydrocarbons in particular.
- The solution was applied in a concentration of 0.5% to 2%.
- There was no change compared to the pilot test.

### 5.3 Injection type

- The injection was performed through eight new double injection wells, which were installed as part of the Remediation project:
- Shallow strainer from 0 (water surface) to 3 meters deep.
- Deep strainer - from 3.5 meters to 8 meters deep.
- At the end of the injections, air was injected for about three weeks to disperse the oxidants in the horizontal dimension.
- The injection wells were placed as a rounded mesh cluster, 4 m apart.

### 5.4 Radius of influence

With no change from the pilot, as described in section 4.4





## 5.5 Process and performance monitoring

The injections included:

- Mixing the chemicals and preparing the injection solution in an outdoor facility.
- Transferring the injection solution to the site with the help of a dedicated tanker.
- Positioning the tanker on an elevated ramp at the site (20 m above the wellheads) and flowing the solution to the heads to the control and manifold.
- The control and monitoring manifold included a main faucet and a pressure gauge which allowed control of the injection flow to the wells and a system of faucets for controlling the flow of the solution to each faucet separately.
- A safety surface, made of flexible and thick HDPE (high density polyethylene) plastic, is spread out under the working point and the pipe branch, to prevent leakage outside the activity area in case of emergency.



## 6. Post treatment and/or Long Term Monitoring

### 6.1 Post treatment and/or Long Term Monitoring

A VOC analysis should be performed to detect chlorinated carbon concentrations as a result of the "rebound" effect.

## 7. Additional information

### 7.1 Lesson learnt

Injecting the oxygen at high pressure may cause it to leak from the surface of the soil. It should be injected at an adjusted pressure that will not cause leakage.

### 7.3 Training need

Training through workshops, preferably by the Ministry of Environmental Protection in order for the remediation processes to comply with the regulator's guidelines.

## 1. Contact details - CASE STUDY: ISCO n.8

<b>1.1 Name and Surname</b>	LORANT Camille (Site Manager) DEVIC-BASSAGET Boris (Technical Director)
<b>1.2 Country/Jurisdiction</b>	FRANCE: SUEZ RR IWS REMEDIATION FRANCE 17 rue du Périgord, 69330 Meyzieu (France) SPAIN: SUEZ RR IWS IBERICA, Camí Can Bros, 6 08760 Martorell (Barcelona)
<b>1.3 Organisation</b>	SUEZ RR IWS REMEDIATION FRANCE for SUEZ RR IWS IBERICA
<b>1.4 Position</b>	
<b>1.5 Duties</b>	International remediation team
<b>1.6 Email address</b>	<a href="mailto:Camille.lorant@suez.com">Camille.lorant@suez.com</a> <a href="mailto:boris.devic-bassaget@suez.com">boris.devic-bassaget@suez.com</a> <a href="mailto:contact.remediation.europe@suez.com">contact.remediation.europe@suez.com</a> <a href="mailto:Juan.Marti@suez.com">Juan Marti@suez.com</a>
<b>1.7 Phone number</b>	+33(4)72450222



## 2. Site background

### 2.1 History of the site: Challenges and Solution

The site is located in the Salberdin industrial area within the town of Zarautz. Outside its boundaries are urban residential areas formed by collective housing. The Zarautz Railway Station is located in the northeast. The sea is present 500 m north of the site.

### 2.2 Geological and hydrogeological setting

Geological description (below topsoil, asphalt or concrete)

- 0 - 0.5 / 2 m: filling
- 0.5 / 2 - 2 / 3.8 m: clay
- 2 / 3.8 m - 2.2 / 4 m: clay silt
- 2.2 / 4 m -?: Sand

Presence of groundwater in the sand, direction of flow oriented towards the north, with an old channel.

## 2.3 Contaminants of concern

The site presents a contamination of the groundwater for chlorinated compounds in concentrations that exceed the normative reference values (max 23,000  $\mu\text{g/l}$  in cis-DCE and 2100 in vinyl chloride (VC)). A chlorinated plume extends to the west (S28, S6, S8)

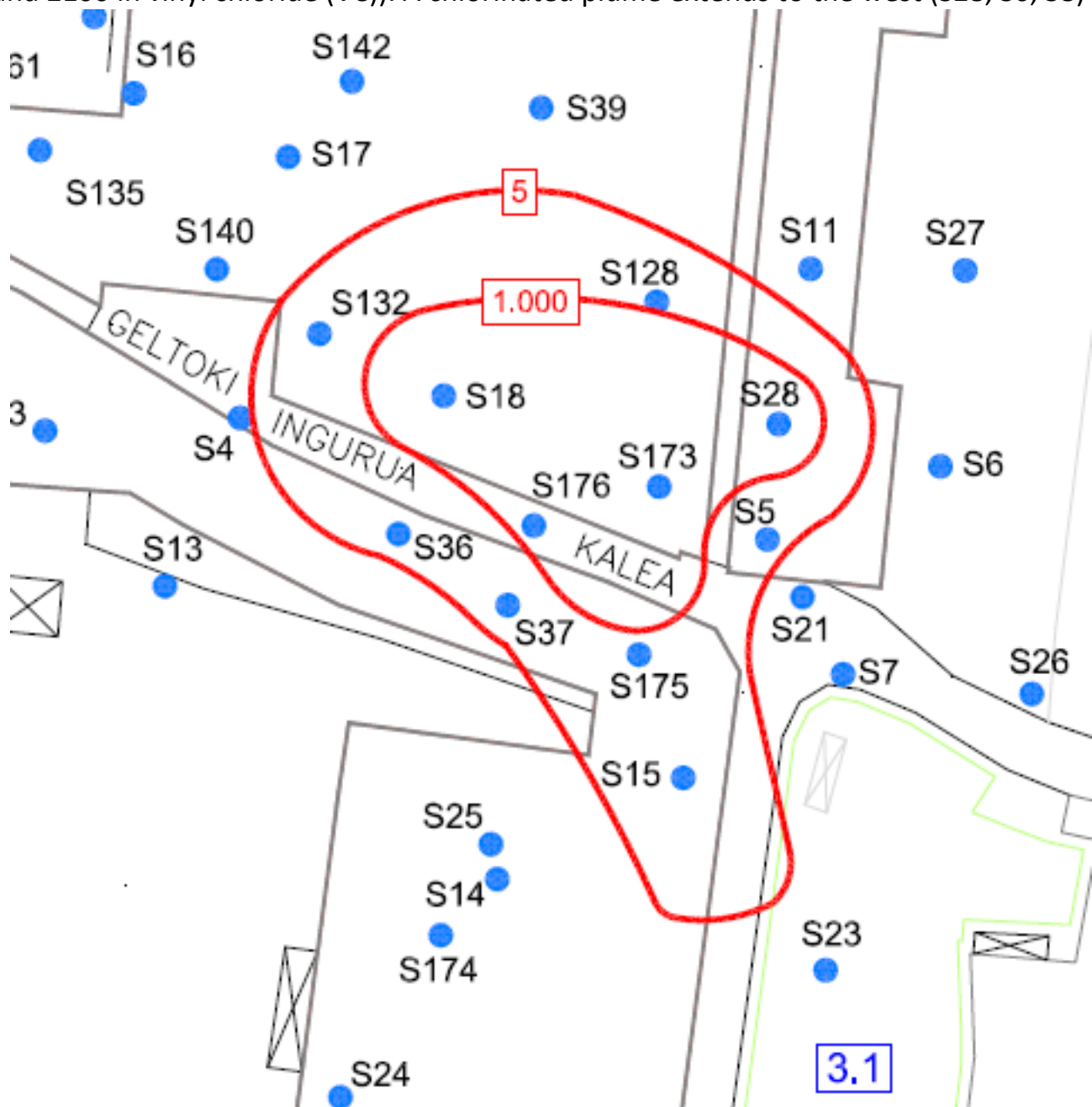

Vinyl chloride plume ( $\mu\text{g/l}$ )

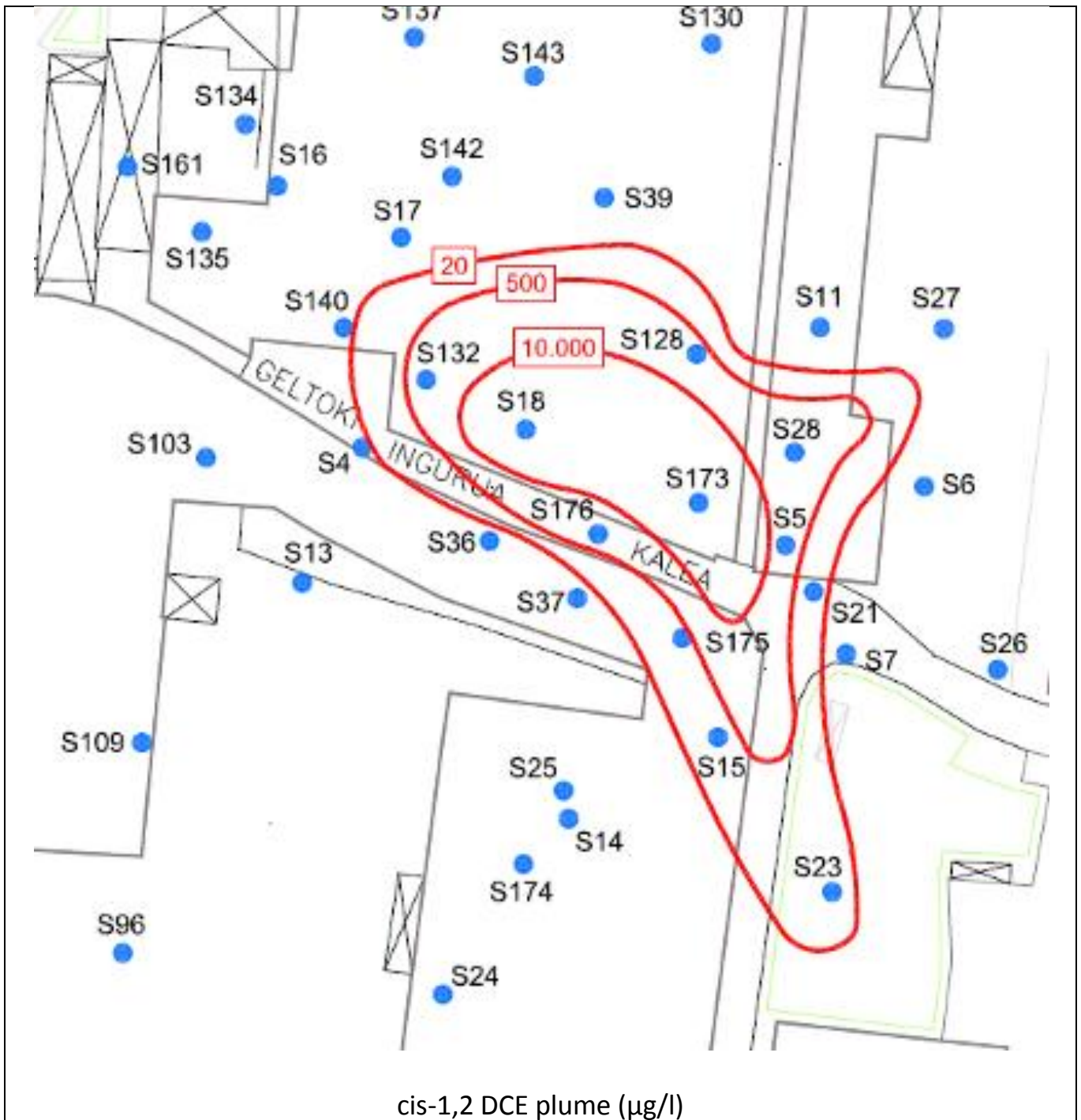



## 2.4 Regulatory framework

The aim of the treatment is to reduce the contaminating mass present in the groundwater and thus reduce or eliminate the potential health risks for the people living around it.

The treatment area corresponds to the right of way of the 88 injectors over a thickness of 10 m of aquifer.

The proposed target values for the impacted groundwater are presented in the table below:

Target values for groundwater ( $\mu\text{g/l}$ )

Interest compound	Target value ( $\mu\text{g/l}$ )
Vinyl Chloride	45
cis-1,2 Dichlorethylene	800
TPH AlifaticsC12-C16	30

Target values for groundwater ( $\mu\text{g/l}$ )

In addition, to evaluate the effectiveness of the treatment, SUEZ Remediation proposes the following reception criteria:

- 80% reduction in the average chlorinated solvent content,
- Minimum reduction of 50% on each individual piezometer,
- No abatement calculation for low concentrations  $<100 \mu\text{g/l}$ .

## 3. Laboratory-scale application in field

We did not carry out a pilot sizing test prior to the implementation of the ISCO treatment.





## 5. Full scale application

### 5.1 Main treatment strategy

The network of injection points consists of 88 points (I1 to I88), by means of a zoning in 3 areas with the following characteristics:

- Concentrated area, with a narrow network of structures of 31 injection points.
- Intermediate area, with a narrow network of structures with 27 injection points.
- Diffuse area, with a narrow network of structures with 30 injection points.

In each of the points, the injection of the reagent is carried out directly on the area where the aquifer develops, that is, on the basal stretch of sand located below the clayey silt and up to 10/12 m deep.

The injections were made with a system of 7 injection plates composed of

A system of non-return valves, a 3.5 bar pressure limiter, and a filter at the water inlet, A sodium permanganate IBC, connected to a dosing pump that allows to dilute the oxidant in line at 1 or 2%

3 lines with 1m<sup>3</sup>/h float flow meters, shut-off valves, to perform injections at each point.

NB: it is possible to connect the injection point directly to the system output to increase the flow rate to 3m<sup>3</sup>/h.

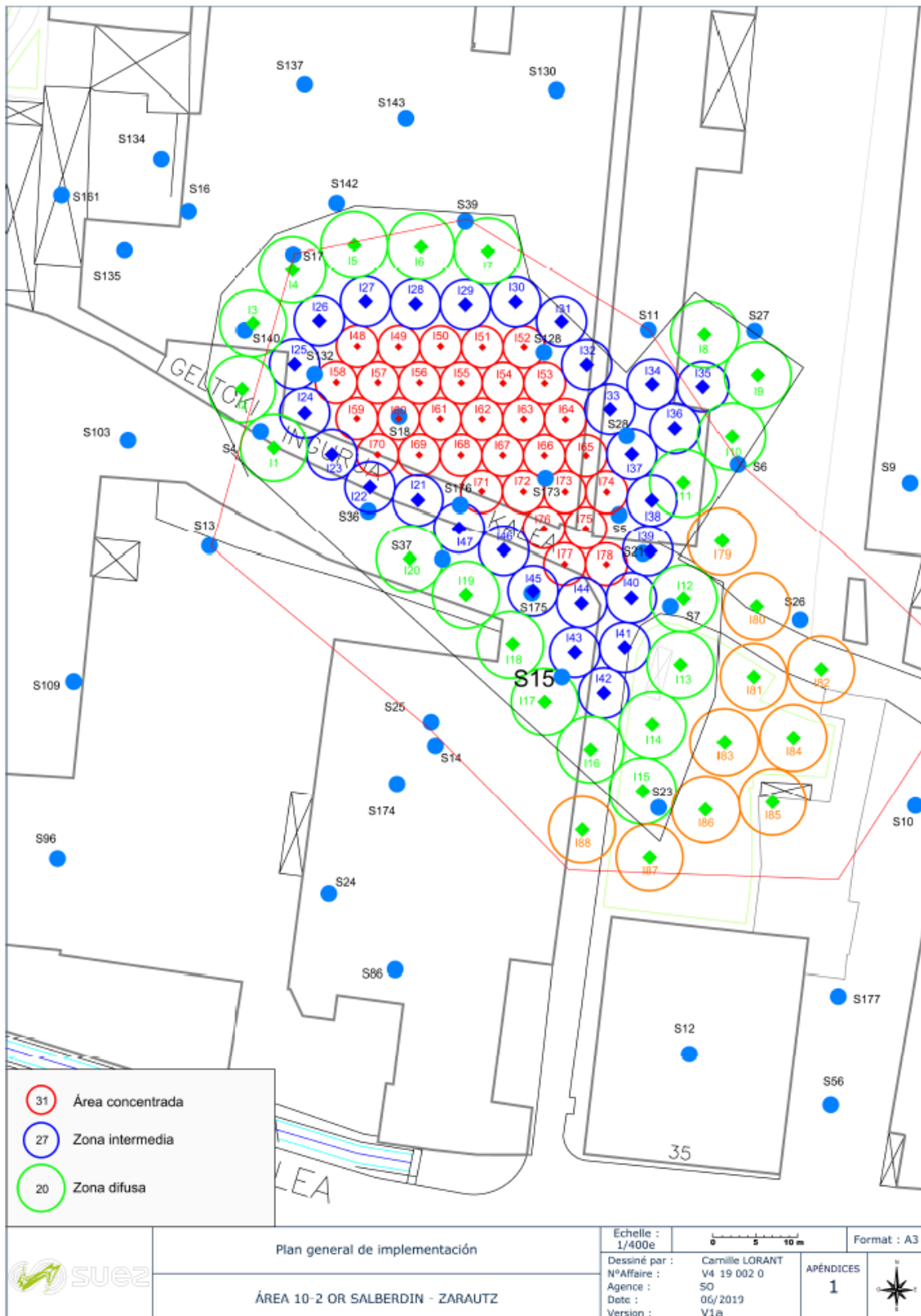









## 5.4 Radius of influence

The theoretical amount of reagent to be injected is based on

- the amount of pollutant present in the aquifer
- the void volume in the aquifer (taking into account the hydraulic parameters of the aquifer in this sector and the important porosity)

The sodium permanganate reagent with a solution dosed at 1 or 2%, is implemented according to several successive campaigns, separated in periods of 3 months.

Oxidant dosage in each of the injection campaigns

ISCO Campaign	Injection point number	Injected volume (m <sup>3</sup> )	Quantity of 40% Permanganate (Tons)
1st campaign	88	1 385,5	19,5
2 <sup>nd</sup> campaign	24, recalcitrant points and/or with rebound effect	751	15: (9 + 5) In order to increase treatment performance according to SUEZ IBERICA and its client, 5 T of additional permanganate were injected during the second campaign

During the first injection campaign, SUEZ Remediation followed the theoretical dimensioning, namely

- Injection in each injector (88)
- Amount of permanganate solution at 40% (I): 16 m<sup>3</sup>
- Average dilution: 1.24%.
- Total volume of injected solution: 1385.46 m<sup>3</sup>
- Injection flow rate: 0.86 m<sup>3</sup>/h

For the second injection campaign, SUEZ Remediation has injected into the injectors where the VOCs were higher than the reference values.

In addition, Suez Remediation increased the dilution % and the injection flows (validated by a field test) to increase the diffusion of permanganate in the groundwater. The parameters are:

- Injection in each injector (24)
- Amount of permanganate solution at 40% (I): 12 m<sup>3</sup>
- average dilution: 1.65%
- Total volume of injected solution: 751.3 m<sup>3</sup>

Injection flow rate: 5.66 m<sup>3</sup>/h



## 5.5 Process and performance monitoring

In order to verify whether the water recovery targets are met and to define the evolution of the targets, the baseline situation will be determined and regular monitoring will be carried out to assess the progress of recovery.

During remediation, all wells and piezometers that present severe affection and values above the quality objectives, will be connected to the remediation system or for monitoring.

Likewise, periodic controls of the unaffected points were carried out to guarantee that the area of dispersion of the affection is not in expansion.

At the end of the treatment, after two injection campaigns, the results are:

For Cis1,2-Dichloroethylene,

- 87 out of 88 injectors have concentrations below the reference values, i.e. 99%
- the average reduction in concentrations between the initial state and the final state is 91%.

For vinyl chloride,

- 81 out of 88 injectors have concentrations below the reference values, i.e. 92%
- the average reduction in concentrations between the initial state and the final state is 91%.

## 1. Contact details - CASE STUDY: ISCO n.9

<b>1.1 Name and Surname</b>	Laura Valeriani, Federica De Giorgi
<b>1.2 Country/Jurisdiction</b>	Italy
<b>1.3 Organisation</b>	Golder Associates S.r.l.
<b>1.4 Position</b>	Engineering consulting firm – Environmental engineers
<b>1.5 Duties</b>	Italian Environmental Law (D.Lgs. 152/06, DM31/15)
<b>1.6 Email address</b>	lvaleriani@golder.it fdegiorgi@golder.it
<b>1.7 Phone number</b>	+39 340 88 95 457





## 2. Site background

### 2.1 History of the site: Challenges and Solution

The Site is a petroleum service station, with fuel storage in underground tanks, located in central Italy.

In 2005, the station was refurbished which included the replacement of the old underground tanks with new ones, which were installed in a different area of the Site. During the excavation for the removal of the old tanks, evidence of contamination was detected in the soil located below the tanks, therefore different environmental investigations were carried out over the year (in 2005, 2013, 2015 and 2017) on various environmental matrices (soil, groundwater and soil gas).

The results of the investigations showed the presence of two potential secondary sources of contamination, with exceedances of the Italian threshold limits (CSC D.Lgs. 152/06 and limits DM31/15):

- unsaturated deep soil (depth > 1m below ground surface (bgs)), with benzene, ethylbenzene, toluene, xylenes, light C<sub>≤12</sub> and heavy C > 12 hydrocarbons and MtBE. The maximum detected concentrations were:

benzene	163	mg/kg SS
ethylbenzene	502	mg/kg SS
toluene	648	mg/kg SS
xylenes	1,472	mg/kg SS
light hydrocarbons C <sub>≤12</sub>	19,509	mg/kg SS
heavy hydrocarbons C > 12	5,742	mg/kg SS
MtBE	736	mg/kg SS

- groundwater, with benzene, toluene, xylenes, total petroleum hydrocarbons and MtBE. The maximum concentrations were

benzene	163	µg/l
toluene	648	µg/l
p-Xylene	1,472	µg/l
Total hydrocarbons (as n-hexane)	19,509	µg/l
MtBE	736	µg/l

A human health risk assessment was developed for the Site, as required by Law. The assessment showed that the human health risk was acceptable but the Italian Law requires that groundwater contaminant concentration, at the wells located at the Site downgradient boundary, must meet with Italian threshold limits (CSC D.Lgs. 152/06 ). Some exceedance were detected in those wells and therefore groundwater remediation was deemed necessary for the site.

A screening of applicable remedial technologies was undertaken, using the screening matrix provided by ISPRA, showing that the best remediation technology for the Site is a combination of ISCO and bioremediation.

ISCO resulted more suitable for the area in which the old tanks were located, because of higher contaminant concentration. Bioremediation, i.e. the delivery of oxygen release compounds in the subsoil to stimulate hydrocarbons aerobic degradation, resulted more suitable at the Site boundary where the concentration of contaminants was lower.

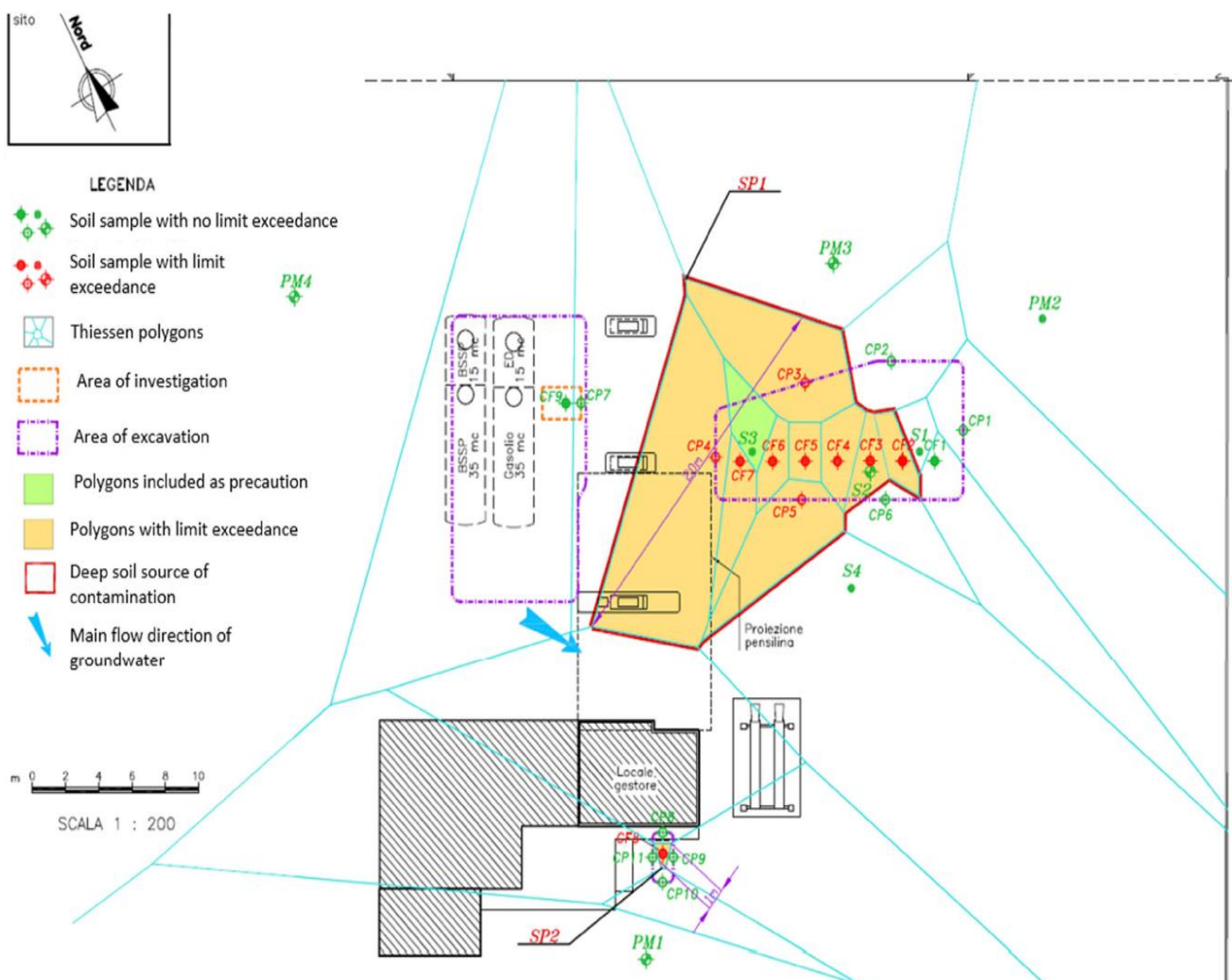

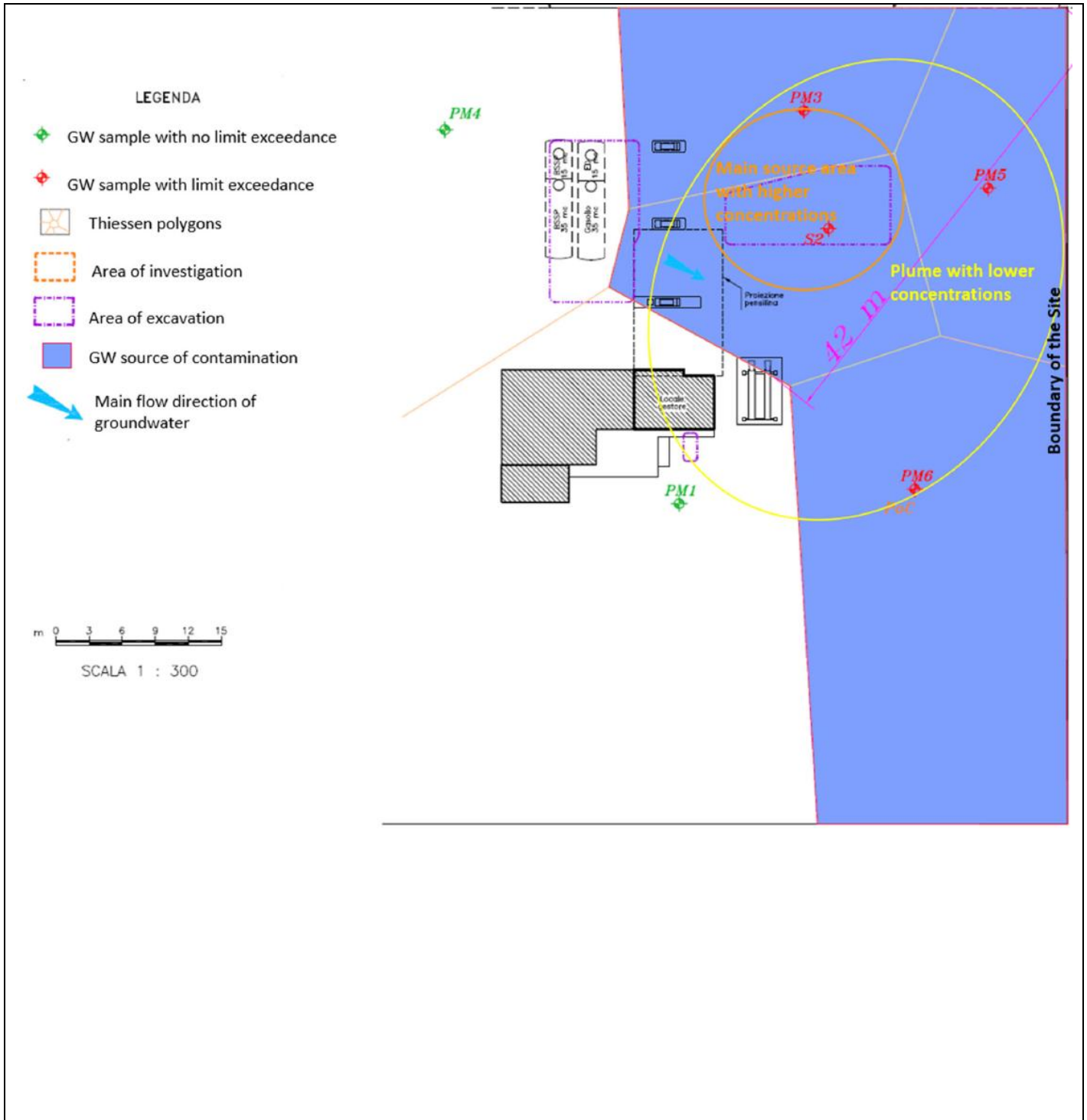



## 2.2 Geological and hydrogeological setting

Site soil consists of fill material up to a depth of 0.8 m bgs, followed by sandy silt or silty clayey sand up to 4.2 m bgs (sandy loam). Below the latter fine to medium-fine sand is found up to the maximum investigated depth equal to 10 m from bgs (loamy sand).



The depth to groundwater is approximately 11 m bgs, with flow direction mainly south-southeast and 0.5% of hydraulic gradient.

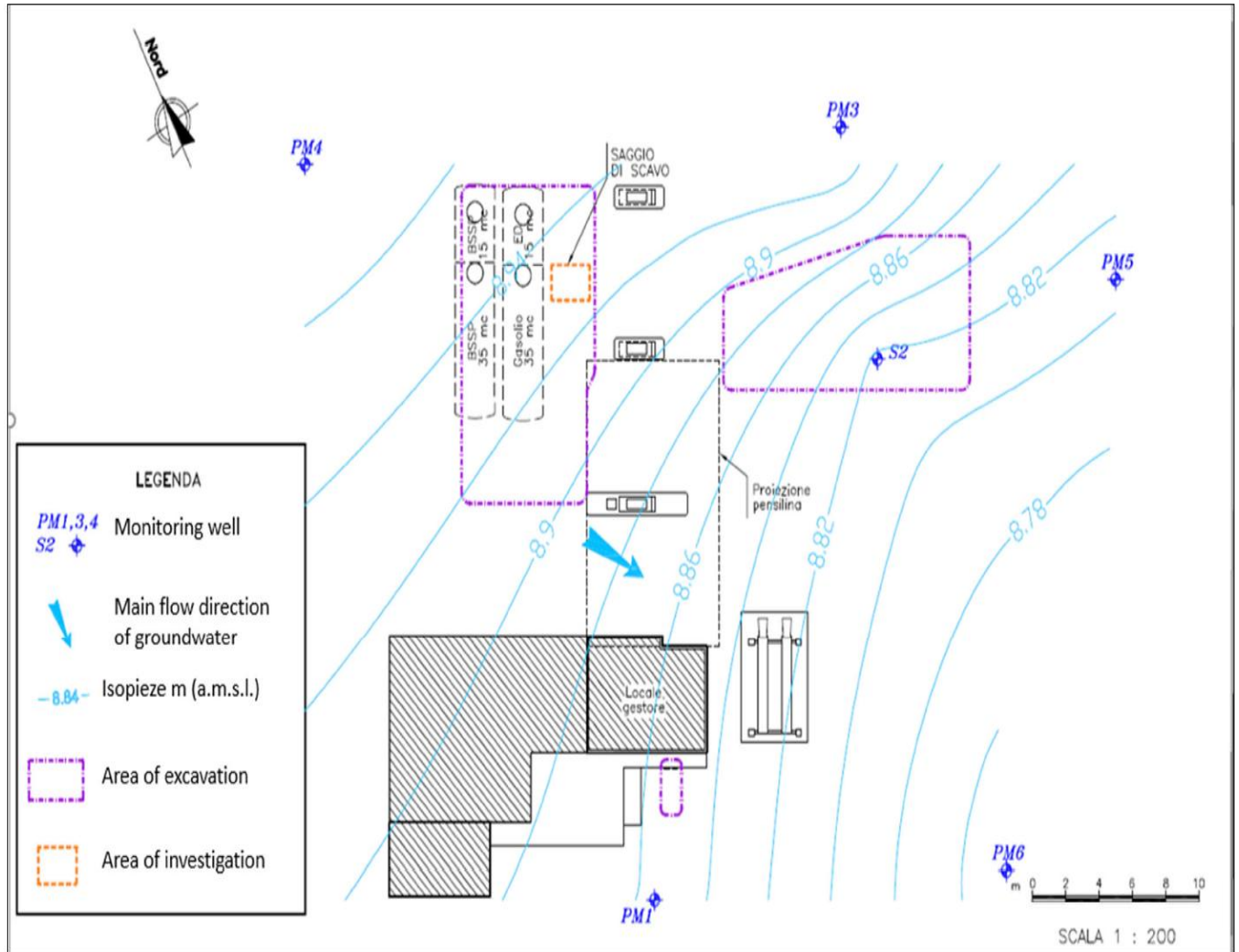



## 2.3 Contaminants of concern

The results of the environmental investigations showed the presence of two secondary potential sources of contamination, with exceedances of Italian threshold values (CSC D.Lgs. 152/06 and limits DM31/15):

- the deep soil (exceedance for benzene, ethylbenzene, toluene, xylenes, light hydrocarbons C<sub>≤12</sub>, heavy hydrocarbons C<sub>>12</sub>, MtBE);
- groundwater (exceedance for benzene, toluene, p-xylene, total petroleum hydrocarbons, MtBE);
- No LNAPL was detected on Site.

A human health risk assessment was developed for the Site, as required by Law. The assessment showed that the human health risk was acceptable but the Italian Law requires that groundwater contaminants concentration, at the wells located at the Site downgradient boundary, must meet with Italian threshold limits (CSC D.Lgs. 152/06 ). Some exceedance were detected in those wells, due to the plume generated from the main source area where the former tanks were located, and therefore a groundwater remediation was deemed for the Site. The tables below shows the results of the comparison of the maximum detected concentration and the risk-based site-specific threshold limits (CSR), which are the remediation targets:

- unsaturated deep soil (depth > 1m bgs), no remediation is needed.

Contaminant	Max conc. on Site	Remediation targets	Unit
benzene	163	163	mg/kg SS
ethylbenzene	502	502	mg/kg SS
toluene	648	648	mg/kg SS
xylenes	1,472	1,472	mg/kg SS
light hydrocarbons C <sub>≤12</sub>	19,509	19,509	mg/kg SS
heavy hydrocarbons C <sub>&gt;12</sub>	5,742	5,742	mg/kg SS
MtBE	736	736	mg/kg SS

No remediation is needed

- groundwater within the site, no remediation is needed.

Contaminant	Max conc. on Site	Remediation targets	Unit
benzene	46	46	µg/l
toluene	3800	3800	µg/l
p-xylene	2619	2619	µg/l
total hydrocarbons (as n-hexane)	13000	13000	µg/l
MtBE	230	230	µg/l

- groundwater at the boundary of the site remediation is needed

Contaminant	Max conc. on Site	Remediation targets	Unit
benzene	3.2	1	µg/l
toluene	<0,13	15	µg/l
p-xylene	<0,16	10	µg/l
total hydrocarbons (as n-hexane)	220	350	µg/l
MtBE	230	40	µg/l





## 2.4 Regulatory framework

The main environmental law in Italy is the Legislative Decree no. 152/2006 (D.Lgs. 152/06) that in Part four, fifth title sets specific rules for remediation of contaminated sites.

Moreover, a specific decree exists for petroleum service stations, Ministerial Decree no. 31/15 (DM31/15), which sets specific simplifications and procedures for those sites. There is no specific legislation for the application of ISCO technology.

The reference legislation establishes some threshold values (CSC D.Lgs. 152/06 and limits DM31/15) for the main contaminants both in soil and groundwater, if during the characterization there are one or more exceedance of threshold values, the site is defined as "potentially contaminated", and a human health risk assessment can be developed to estimate the risks deriving from the potential sources of contamination detected on site (defined by the samples with exceedance) and to calculate risk-based site-specific threshold limits (CSR). The legislature also states which values are of acceptable risk for the assessment.

If the estimated risks are lower than acceptable values, the site is defined as "not contaminated", and no remediation is needed. If the estimated risks are higher than acceptable values, the site is defined "contaminated", and remediation is needed. The risk based site-specific threshold limits (CSR) are the remediation targets.

For the wells located down-gradient site boundary, the Italian Law sets the CSC as targets, and if exceedances are detected, a remediation is required.

## 5. Full-scale application

### 5.1 Main Reagent

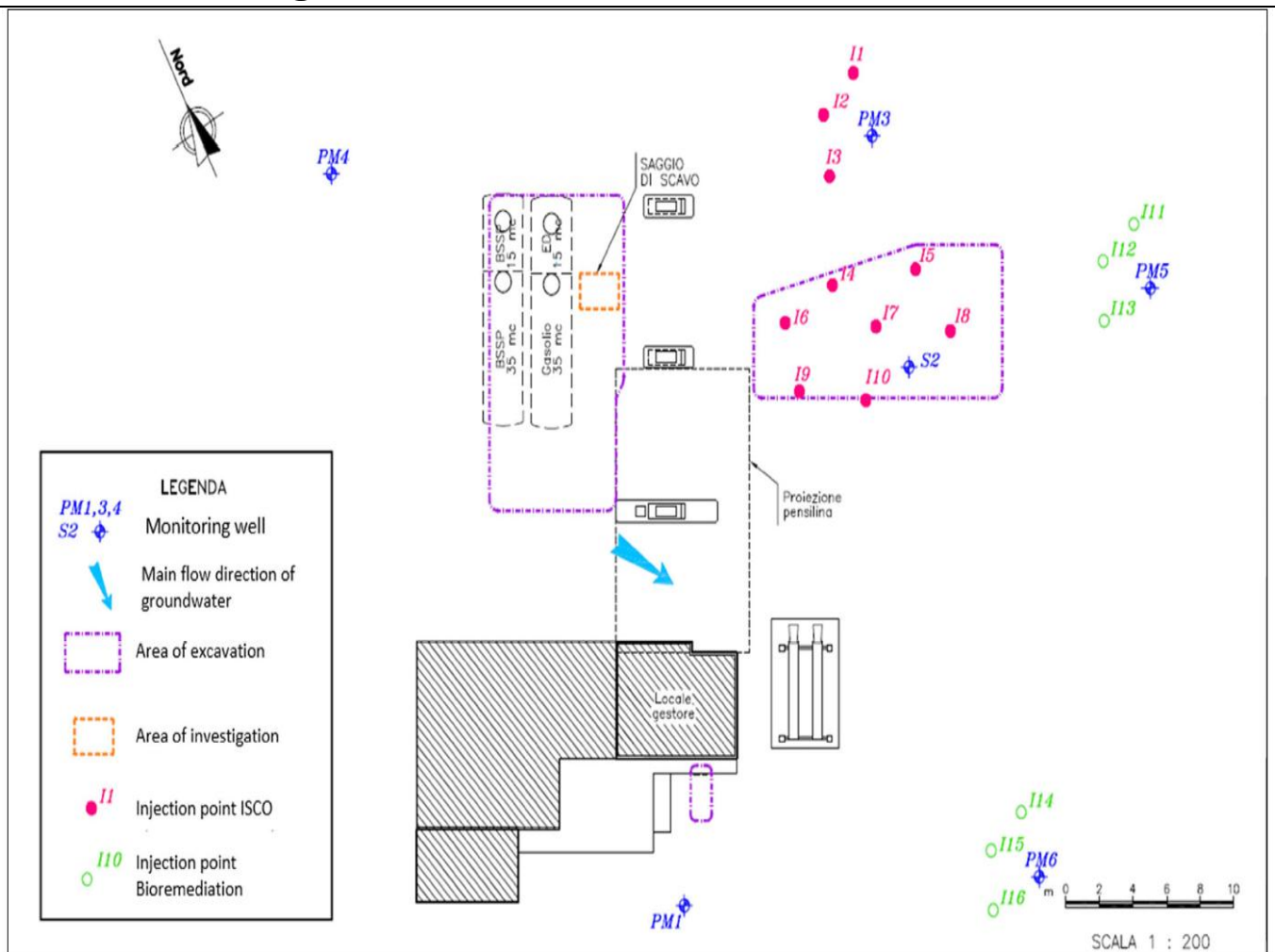

The selected reagent was sodium persulfate ( $\text{Na}_2\text{S}_2\text{O}_8$ ), that needs to be activated to release the persulfate anion and radicals ( $\text{S}_2\text{O}_8^{2-}$ ) in water, which are strong oxidizing agents, successfully applied in similar contexts.

The activation can be performed by several means, in this case study the choice was alkaline activation by adding sodium hydroxide ( $\text{NaOH}$ ).

To accelerate the reduction of the contamination in the boundary wells, it was also chosen to inject an oxygen releasing compound, specifically the calcium peroxide ( $\text{CaO}_2$ ), to enhance bioremediation.

The groundwater remediation was thus conducted by a combination of two technologies:

- ISCO in the main source area (below the old replaced tanks, identified as the



primary source), characterized by higher concentration of contaminants and which generated the plume that extended to the Site boundary. The chosen oxidant was sodium persulfate ( $\text{Na}_2\text{S}_2\text{O}_8$ ), activated by creating an alkaline environment in the groundwater with the addition of sodium hydroxide ( $\text{NaOH}$ ). The oxidant was applied in no. 10 injection points located in the main source area.

- Bioremediation in the area near the Site boundary, invested by the plume generated by the main source and characterized by lower concentration of contaminants. The chosen compound was calcium peroxide ( $\text{CaO}_2$ ). The compound was applied in no. 6 injection points located near the boundary wells that showed exceedance.

The treatment comprised of one single injection event and eventually, after 12 months of groundwater monitoring, a second injection event, to be assessed based on the results of the monitoring campaigns.

The injection points were drilled between March 13 and April 6, 2018, by installation of “manchette tubes” (see paragraph 5.3 for detailed information), while the injection activities took place between May 7 and May 11, 2018, applying the following dosages:

- Main source area, ISCO treatment (injection points I1÷I10): a solution of sodium persulfate, water and sodium hydroxide (as activator) was injected with the following dosages:

Thickness of injection	5	m
Dose of sodium persulfate per point	150	Kg
Slurry of sodium persulfate per point (diluted 15%)	1000	L
Sodium hydroxide diluted 25% per point (as activator)	288	L

- Wells near the boundary, Bioremediation treatment (injection points I11÷I16): a solution of calcium peroxide and water was injected with the following dosages:

Thickness of injection	5	m
Dose of sodium persulfate per point	53	Kg
Slurry of sodium persulfate per point (diluted 20%)	265	L



## 5.2 Additives

Sodium persulfate ( $\text{Na}_2\text{S}_2\text{O}_8$ ), the selected oxidant for ISCO remediation in the main source area, needs an activator that allows its decomposition in persulfate anions and radicals ( $\text{S}_2\text{O}_8^{2-}$ ), which are strong oxidizing agents. The chosen activator was sodium hydroxide (NaOH) at 25% concentration, able to create an alkaline environment in groundwater.

Sodium persulfate activated with alkaline environment was applied successfully in similar contexts.

## 5.3 Injection type

To perform the injection no. 16 new injection points were introduced on site, by drilling and installing no. 16 manchette tubes, with valves located every 50 cm between 10 and 15 m bgs, which is the saturated zone to be treated.

In the main source area no. 10 injection points were installed following an orthogonal grid to the main direction of flow separated by a distance between 3 and 5 m.

While in the area near the Site boundary no. 3 injection points with interdistance between of the injection of approximately 3 m were installed upstream each of the two impacted well (n. 6 points in total). As mentioned before the treatment comprised one single injection event and eventually, after 12 months of groundwater monitoring, a second injection event, to be assessed based on the results of the monitoring campaigns.

The injection points were drilled between March 13 and April 6, 2018, by the installation of “manchette tubes”, while the injection activities took place between May 7 and May 11, 2018.

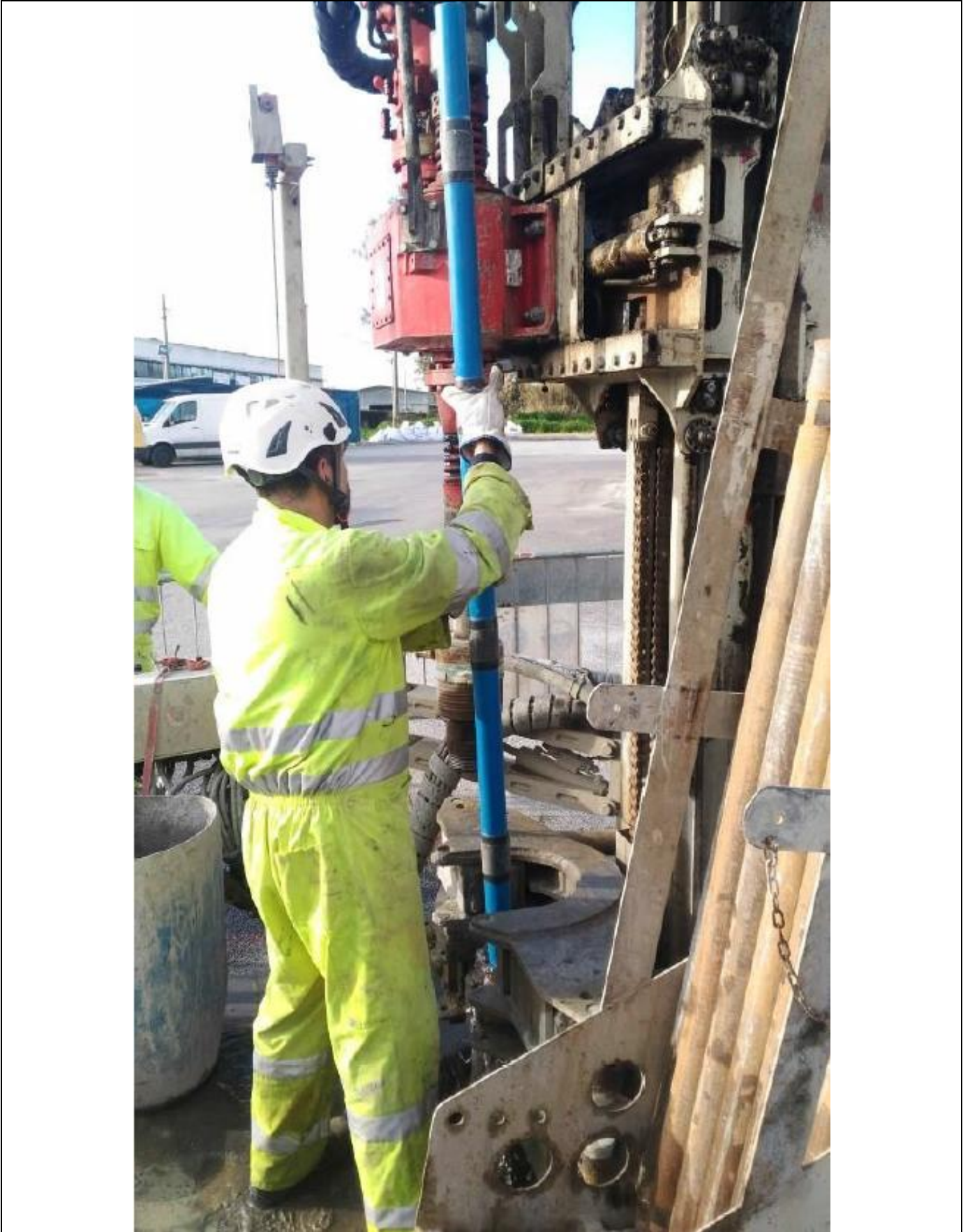





## 5.4 Radius of influence

Radius of influence estimated for the geology found on Site (medium-fine sands) is about 3 m.

## 5.5 Process and performance monitoring

The monitoring of the remediation lasted one year following the schedule below:

- Before the injection (December, 2017):
  - first monitoring campaign, with groundwater sampling and measurement of physic-chemical parameters in all monitoring wells, to be used as an initial value (t0) to verify the progress of the treatment;
- Injection as illustrated in paragraphs 5.1 and 5.3 (May, 2018);
- During the first three months after the injection (June, July and August, 2018):
  - monthly monitoring of all monitoring wells, with sampling of groundwater and measurement of chemical-physical parameters;
- From the fourth to the twelfth month after the injection (November, 2018, February and May, 2019):
  - quarterly monitoring of all monitoring wells, with sampling of groundwater and measurement of physic-chemical parameters;

The physic-chemical parameters measured using a multiparameter portable probe were the following:

- temperature;
- redox potential;
- pH;
- electrical conductivity;
- dissolved oxygen.

The samples collected from the wells were chemically analyzed to determine the concentration of the following parameters:

Parameter	Method
BTEX+S	EPA 5030C 2003 + EPA 8260D 2018
total hydrocarbons (as n-hexane)	ISPRA Man 123 2015 - Metodo A+B
MtBE	EPA 5030C 2003 + EPA 8260D 2018
Sulphates	UNI EN ISO 10304-1:2009
Nitrates	UNI EN ISO 10304-1:2009

The last monitoring campaign was supervised by the local authorities who sampled the wells located at the boundary, validating the results obtained.

The remediation was completed successfully in the estimated time and one single injection event.

Based on the results the second injection events was not undertaken. Since both the Authority's and project manager results met remediation targets, the remediation process was certified as being concluded.

In the charts below is shown the contamination reduction obtained in S2, located in the main source area and in PM5 and PM6, both located at the boundary:

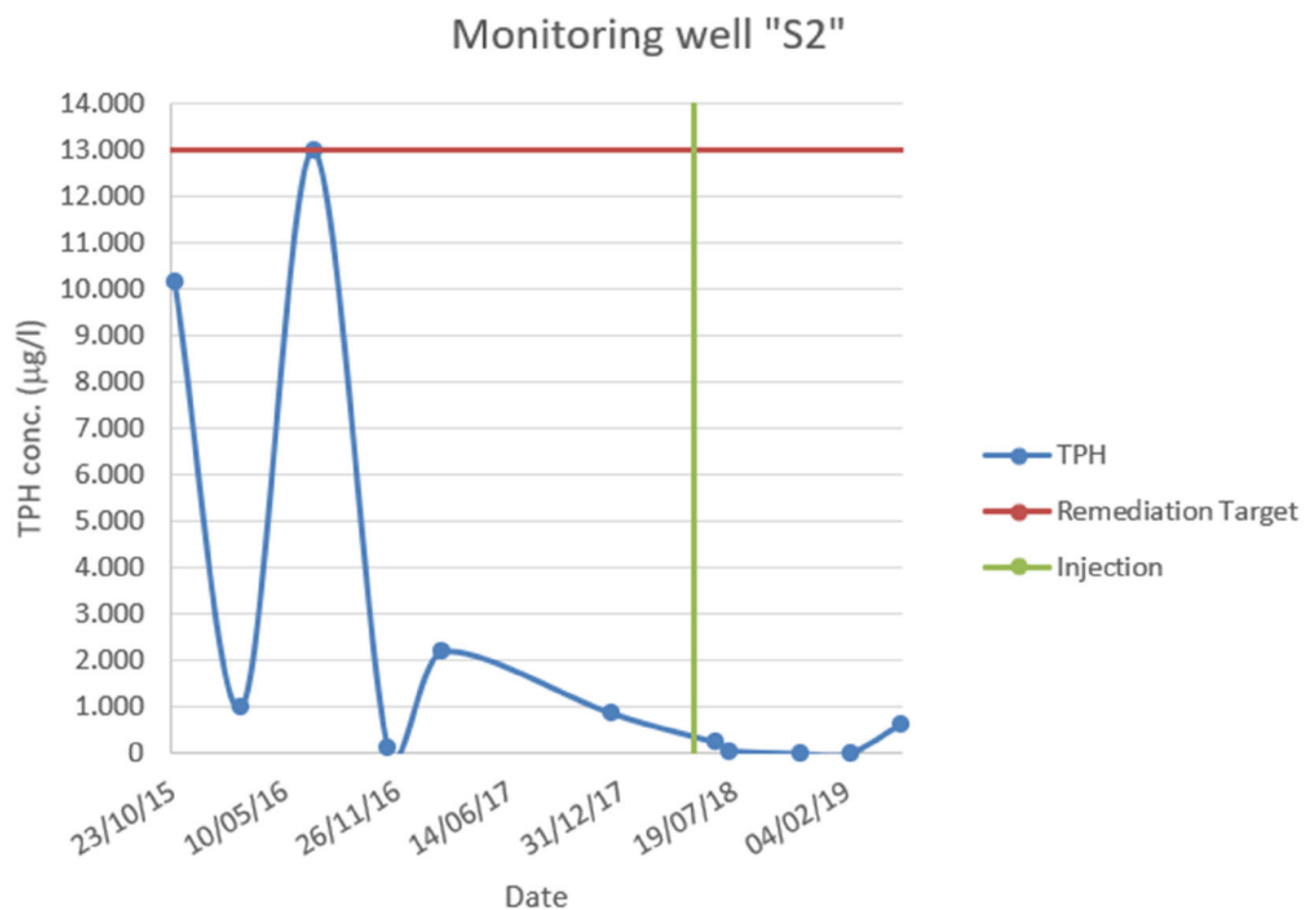



Monitoring well "S2"

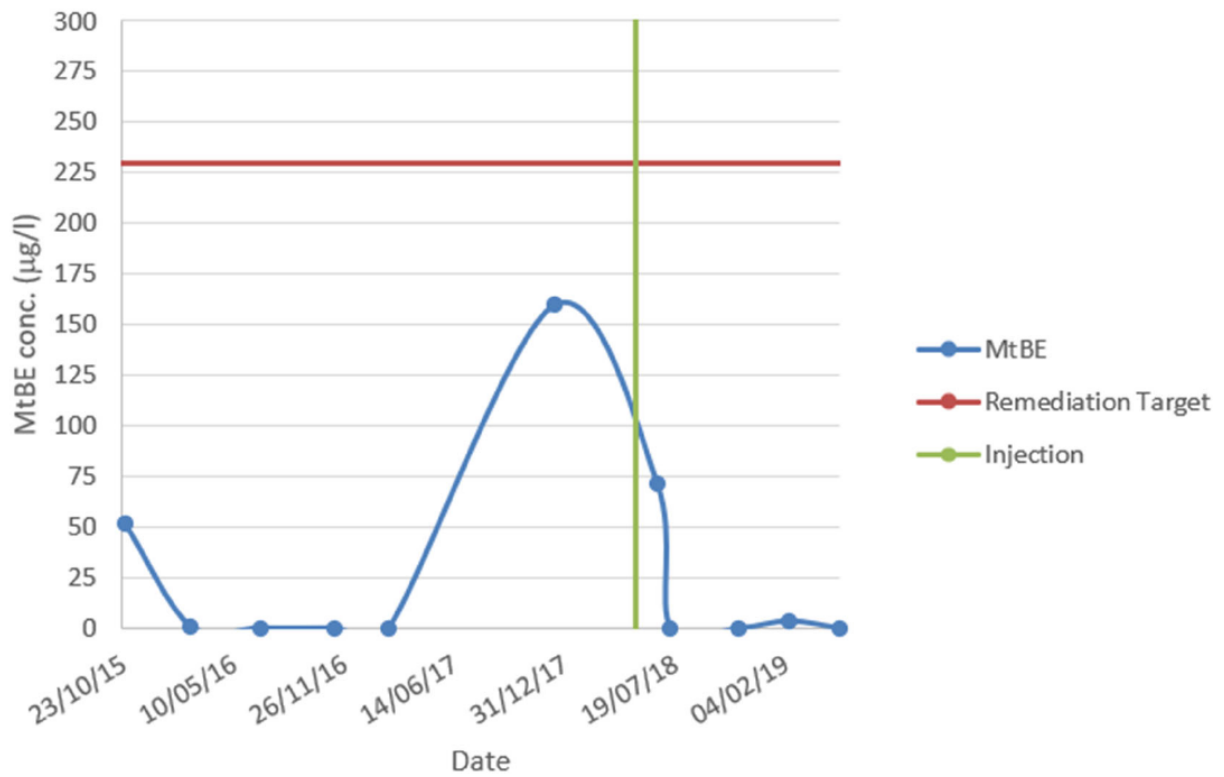

Monitoring well "PM5"

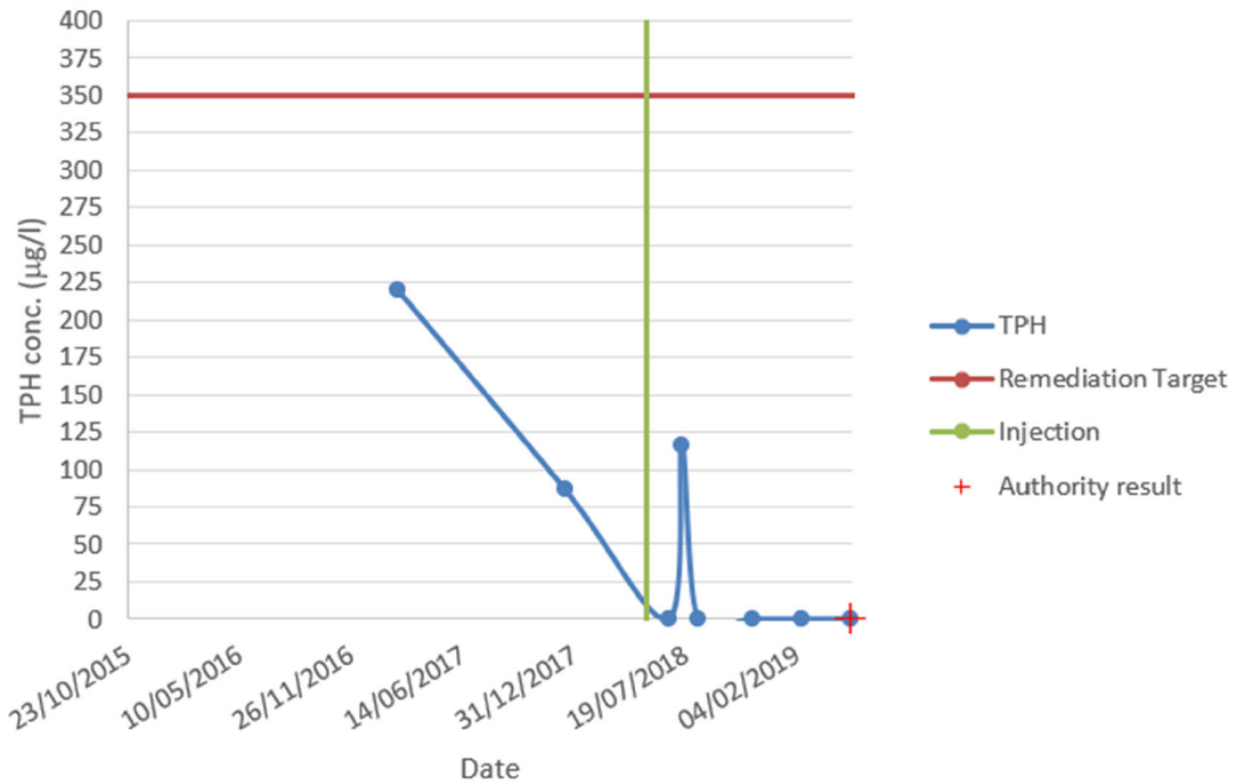

Monitoring well "PM5"

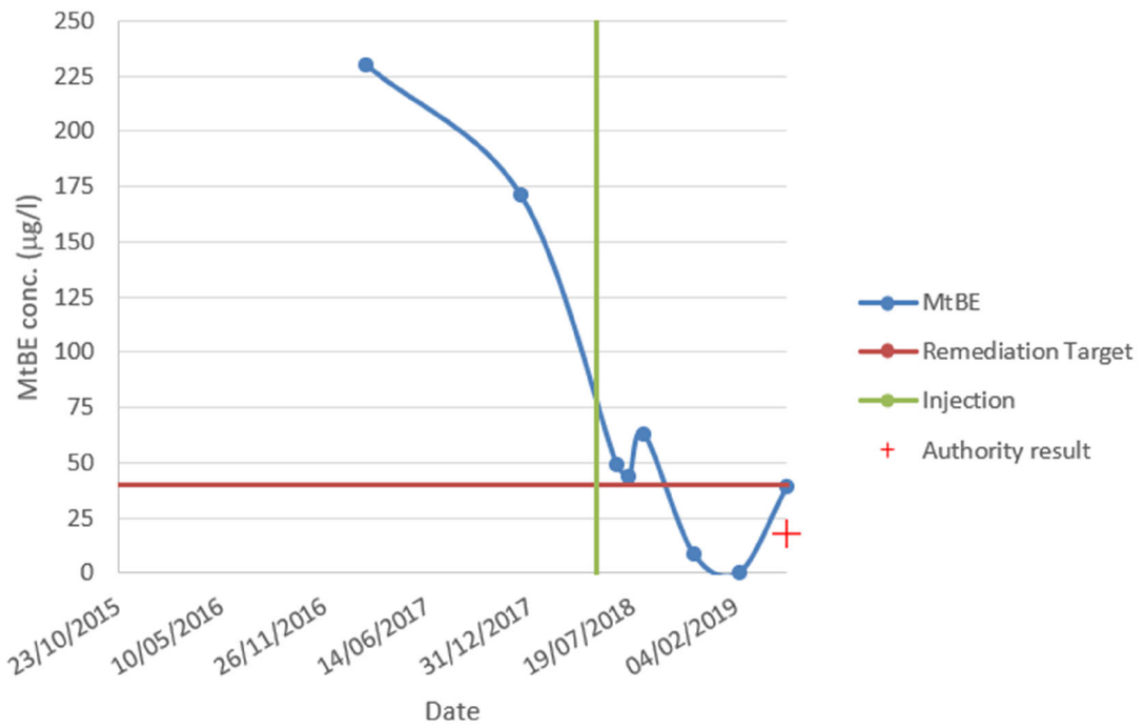

Monitoring well "PM6"

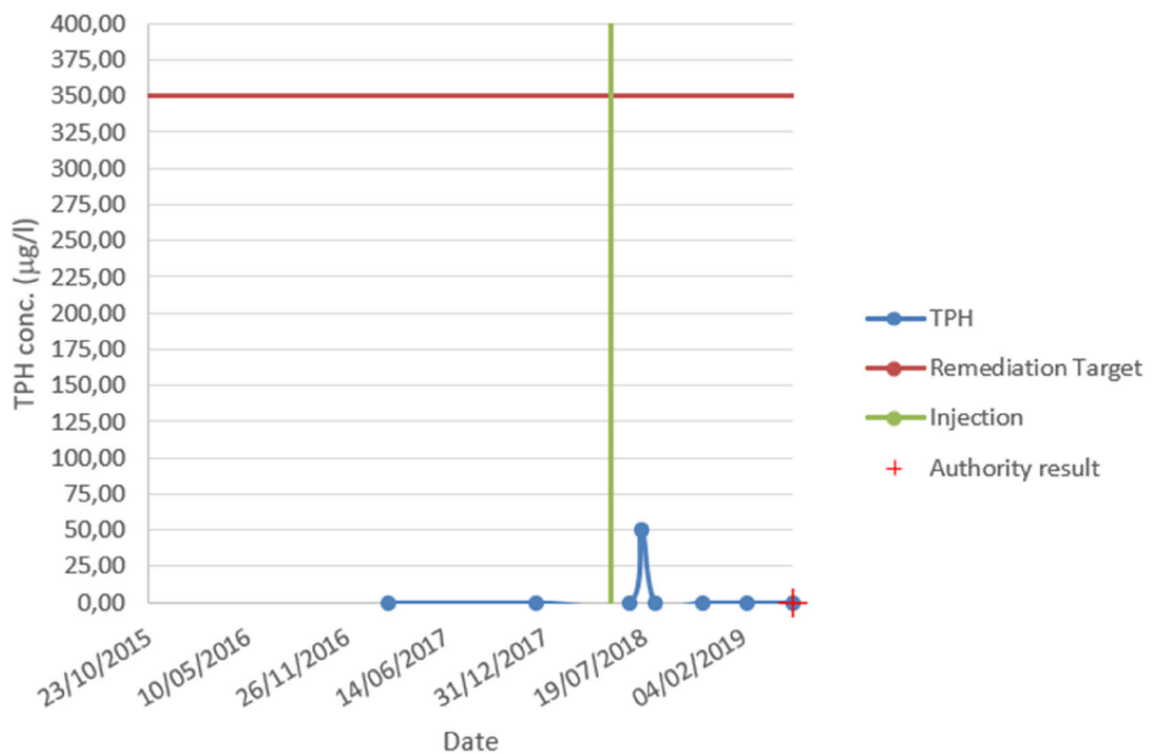

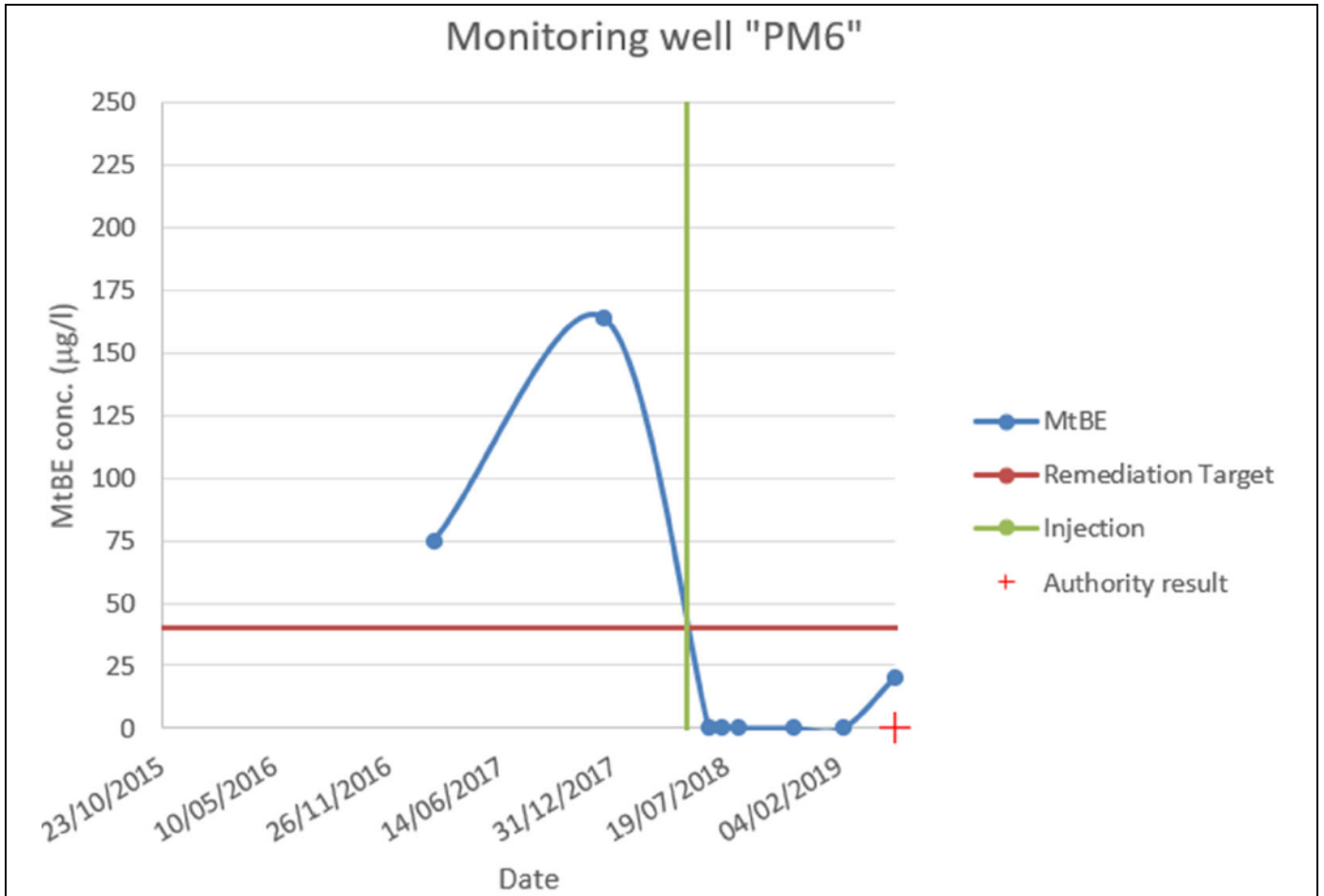

## 1. Contact details - CASE STUDY: ISCO n.10

<b>1.1 Name and Surname</b>	Christelle Tarchalski
<b>1.2 Country/Jurisdiction</b>	France
<b>1.3 Organisation</b>	ARTELIA
<b>1.4 Position</b>	Hydrogeology team manager / Project Manager
<b>1.5 Duties</b>	Contaminated land (from the desk study phase all the way to the reception of the rehabilitation works) & hydrogeology (water resource management and geothermal studies)
<b>1.6 Email address</b>	Christelle.tarchalski@arteliagroup.com
<b>1.7 Phone number</b>	+33 6 27 70 70 94



## 2. Site background

### 2.1 History of the site: Challenges and Solution

- Former petrol station which had been dismantled and is in the process of ceasing activities
- Impact of soil and groundwater due to an incident – release of hydrocarbons
- Preliminary remediation works on the unsaturated zone using digging techniques and on-site treatment with biopile and landfarming
- Identification of residual impacts around the groundwater table which were not accessible using excavation techniques (close to site boundaries / Soil stability)
- Implementation of laboratory testing to identify the best solution and design of the solution based on ISCO technique.
- Implementation of the ISCO technique (one campaign) at the site and reception of the treatment based on soil results after 1 year and monitoring of groundwater and soil gas quality over 2 years after the injection.

### 2.2 Geological and hydrogeological setting

Geology: 0 to 0.2m – pavement or topsoil; 0.2 to 0.8m – made ground; 0.8 to 5m – clayey silt; 5 to 6m – marl limestone

Groundwater encountered at around 4.15 to 4.50m below ground level

Very low permeability of the clayey silt



## 2.3 Contaminants of concern

Contaminants of concerns:

- Total petroleum hydrocarbons and BTEX

Concentrations in the soil:

- TPH C5-C10: 250 up to 1,500 mg/kg
- BTEX: 80 up to 820 mg/kg
- And to a lesser extend: TPH C10-C40: 120 up to 3 100 mg/kg (mainly C12 to C21)

Maximum concentrations in the groundwater:

- TPH C5-C10: 52 000 up to 48500 µg/l
- BTEX: 43,000 up to 96980 µg/l
- And to a lesser extend: TPH C10-C40: 780 up to 7920 µg/l

No free-phase products.

No clean up goals –the aim was to improve the quality of the soil regarding residual concentrations of hydrocarbons

Treatment to be focussed on the soil around the groundwater table as the residual impacts are located in this area.

## 2.4 Regulatory framework

Site into the process of ceasing activities (ICPE)

Guideline for contaminated site of 2017 – remediation of source area: The April 19th 2017 ministerial Note.

Remediation targets for former motorway petrol station were used but there were no regulatory remediation targets as such – these values are defined during a study conducted by a group of petrochemical companies, motorway operators and consultants in order to harmonise practises: “Approche méthodologique harmonisée pour la gestion de stations-services autoroutières – Guide de mise en oeuvre – Décembre 2005 – A37808/C”



## 3. Laboratory-scale application in field

### 3.1 Laboratory scale application

Phase 1 – test with different oxidant during 48h

Tests on soil mixed with groundwater samples collected at the site:

- Potassium permanganate
- Sodium persulfate:
  - Activated in alkaline conditions
  - Activated with hydrogen peroxide
- Fenton (hydrogen peroxide catalysed with iron under 3 different forms)
- Concentrations of oxidizing agent selected based on a stoichiometric approach and a SOD test

Total of 6 tests + 1 test as a reference

Following the phase 1, results indicated that the potassium permanganate was the most efficient and therefore selected for the phase 2.

Phase 2 – assessment of the concentrations and the dosage of the oxidizing agent :

- Total of 4 tests: 2 doses x 2 concentrations during 48h

Results indicated that a high dose and a high concentration were optimal, especially on BTEX and C5-C10.

In phase 1 and 2, monitoring was conducted before and after the test – each jar was analysed for TPH C5-C10, TPH C10-C40 and BTEX.

In phase 2 colorimetric tests were also conducted at the end of the test.





## 4. Pilot-scale application in field

No pilot scale application in the field due the small size of the area to be treated

## 5. Full-scale application

### 5.1 Main Reagent

The oxidizing agent was injected into the ground between 3.5 and 8m bgl using direct push technique (Geoprobe).

The injection was conducted in 2 successive phase:

- Phase 1: injection across all the impacted area: each injection point was around 1 apart (the radius of influence was estimated around 1m due to the low permeability of the soil – this hypothesis was checked and confirmed at the beginning of the injection)
- Phase 2: injection in-between the injection points of the Phase 1 in the most contaminated area

The works for conducted over a period of 3 weeks.

Total of 83 injection points (over around 200m<sup>2</sup>) and of approximately 25m<sup>3</sup> of sodium permanganate at 20%.

Injection points were placed using a grid on a plan and in a staggered arrangement.

The injection pressure was at the maximum of around 2 to 4 bars.

### 5.5 Process and performance monitoring

- Soil boring was conducted regularly to confirm the radius of influence of the injection points and that the oxidizing agent was diffusing homogeneously over the length of the injection (between around 4 and 8m bgl) – controls were done visually as the permanganate has a violet colour.
- Groundwater in the piezometer at and around the treated area were also controlled – visual control as the permanganate has a violet colour and in the laboratory to measure the percentage of remaining oxidizing agent and to analyse TPH and BTEX.



## 6. Post treatment and/or Long Term Monitoring

### 6.1 Post treatment and/or Long Term Monitoring

Monitoring of groundwater and soil gas over 2 years after the injection.

As soon as the colouration had disappeared, groundwater samples were tested for TPH C5-C10, TPH C10-C40

After 12 months, soil samples were taken from the treated area – results indicated a real improvement in soil quality. Soil results were used as an indicator for defining the success of the treatment.

Results indicated a reduction of 65% of the mass of the contaminants of concern.

## 7. Additional information

### 7.1 Lesson learnt

- In soil of low permeability, the colour may be retained for a longer period of time in the ground, however, often at very low percentage – colorimetric tests are a very simple and good approach.
- In low permeability soil, the time for the ground/groundwater to find a new equilibrium after the injection can be very long (up to 24 months)

### 7.2 Additional information

- Chemical processes / molecules are relatively well-known.
- A key success factor is the understanding of geological and hydrogeological conditions at the site and to some extent the geochemical conditions. This is the first things to consider when thinking about techniques to use and coming up with the best strategy for treating the impacted area.
- You have to control the volume/quantity of oxidizing agent that you are storing on the site during the treatment – storing too much oxidizing agent may demand that you obtain a permit for doing so.

### 7.3 Training need



- Workshops are a good approach to exchange experiences and get the basic knowledge and tools to be able to face real situation
- On the job training to allow people to be confronted to real situation – as there is a gap between the theory (what we can read in books and hear from others) and what is really happening in the field.

## Glossary of Terms

<b>Term (alphabetical order)</b>	<b>Definition</b>
BTEX	Benzene, toluene, ethylbenzene and xylenes
TPH	Total petroleum hydrocarbons
M bgl	Meter below ground level

## 1. Contact details - CASE STUDY: ISCO n.11

<b>1.1 Name and Surname</b>	Harald Opdam
<b>1.2 Country/Jurisdiction</b>	The Netherlands
<b>1.3 Organisation</b>	Heijmans Infra BV
<b>1.4 Position</b>	Lead Engineer
<b>1.5 Duties</b>	
<b>1.6 Email address</b>	<a href="mailto:hopdam@heijmans.nl">hopdam@heijmans.nl</a>
<b>1.7 Phone number</b>	+31 (0)73 543 59 00

## 2. Site background

### 2.1 History of the site: Challenges and Solution

For several years, a manufacturing facility was in operation at a location near the city center of Uden, Netherlands. As a result of business activities at the site, soil and groundwater have been impacted with chlorinated hydrocarbons. Following demolition of the buildings in 2005, site investigations revealed high levels of contamination. In the groundwater aquifer, concentrations of more than 16,000  $\mu\text{g/l}$  of trichloroethylene (TRI) were measured, indicating the presence of a source zone (SZ). The impacted SZ is 270  $\text{m}^2$  and contaminated in the saturated zone from 3.0 to 7.0 meters below ground level. For the planned redevelopment of the site into a residential area, the local regulatory authorities mandated remediation of the contaminations to stringent clean-up target levels.



Site overview and location source zone

Following detailed Site Investigations (SI), as per standard operating procedures the first step was excavation of contaminated soils to the top of the groundwater level, and then backfilling the area with certificated clean soils. In view that the envisioned end-use by a real estate developer following the land transaction was construction of residential housing, rapid remedial results were required. As elements of the Remedial Options Appraisal (ROA) process, selection of a technological solution required high reliability, cost-effective implementation and quick results as key objectives. The engineering consultants conducted the SI and were involved with results verification, whereas the lead contractor was responsible for overall project management including technology selection, remediation design and implementation.



## 2.2 Geological and hydrogeological setting

The site is located in between two geological shear zones (Peelrandbreuk en Raambreuk) which mark the transition from the higher Peelhorst area (+20 meter above sea level) tot the lower Roerdalslenk area (+10 meter above sea level).

The surface level at the location is about +16.5 meter above sea level (masl). The groundwater table is located at 3.0 meters below surface (mbs). The groundwater flow is in south-west direction with a hydraulic gradient of 0,002 m/m.



Drill core borehole (sonic drill)

Below the groundwater table until a depth of 16 mbs the site consists of medium fine to coarse sand. Locally some gravel layers and silty clay are present. The fraction organic carbon (Foc) is less than 0.5 %. The hydraulic conductivity varies between 2 and 20 m/day and the effective porosity is about 27.5%.

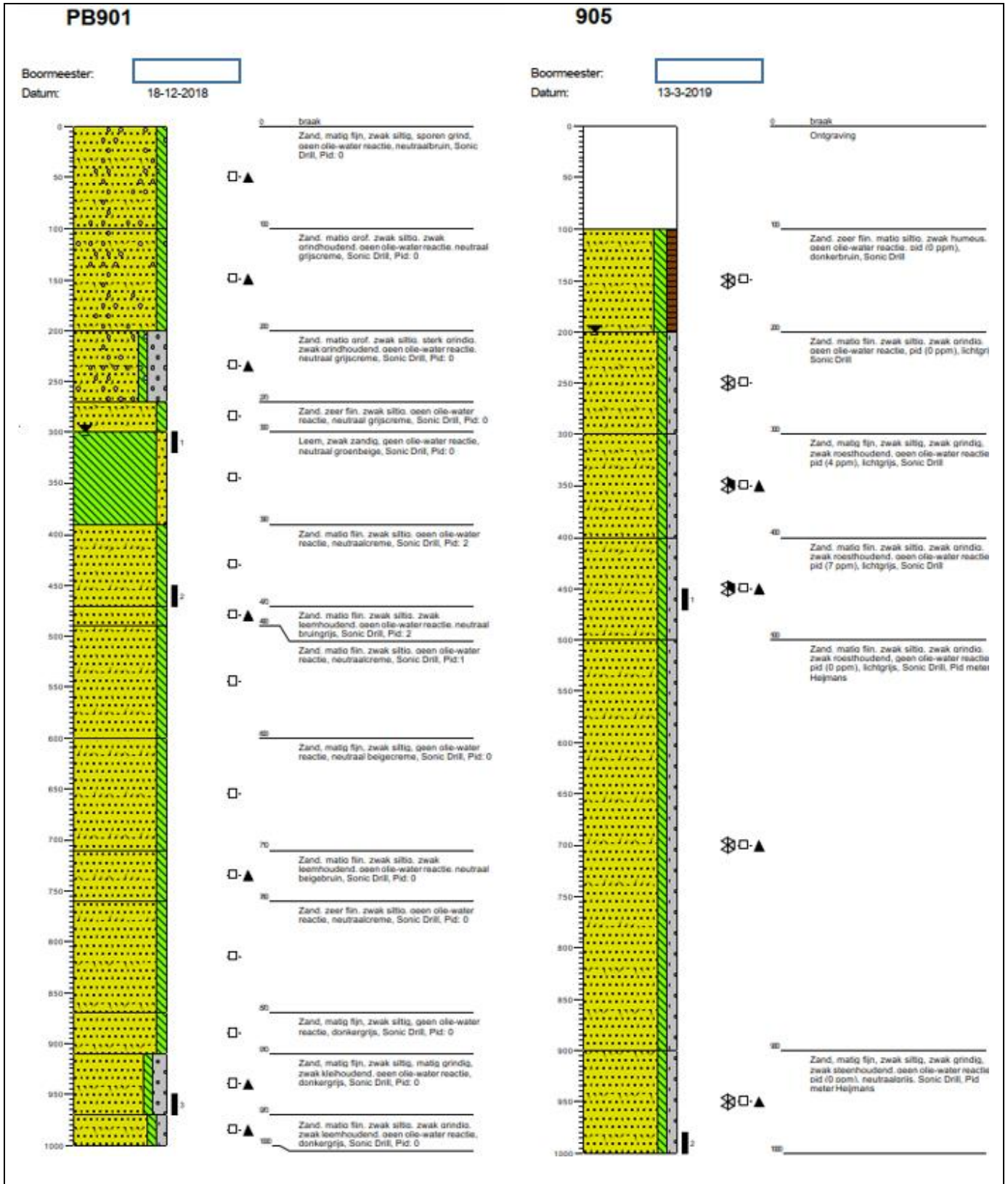



## 2.3 Contaminants of concern

The contaminants of concern are chlorinated solvents, especially trichloroethylene (TRI). Concentrations of more than 16,000  $\mu\text{g/l}$  of trichloroethylene (TRI) were measured in the saturated zone.

In the unsaturated zone more than 16,000 mg/kg of TRI was present.

A NAPL is not demonstrated and the soil contamination in the saturated zone is negligible.





## 2.4 Regulatory framework

The quality of the top 1 meter has to meet the standards for Maximale waarde Wonen (MWW). In the subsurface there should be a substantial removal of contamination in order to create a stable groundwater plume. Therefore the remediation goal for the saturated source zone is as follows:

Contaminant	Target value [mg/kg]	Target value [ µg/l]
TRI	0,5	2500
CIS	-	1000
VC	-	450

## 3. Laboratory-scale application in field

### 3.1 Laboratory scale application

The ISCO-remediation design was based on expert judgement. There was no time available to perform a batch test.

The Foc was assumed to be less than 0.5%.

The soil oxidant demand was assumed to be 3.0 g Persulfate/kg soil. Together with the amount of oxidant needed for the pollution, this resulted in an amount of 9,225 kg Persulfate (Klozur One) for the total source zone (safety factor 1.5).

## 4. Pilot-scale application in field

### 4.1 Main treatment strategy

The Klozur® One ISCO technology was selected primarily because it met all ROA objectives. The blend of sodium persulfate with built-in activation chemistry provided powerful oxidation capacity as a “ready to use” product suitable for this highly contaminated treatment area. A total of 9,225 Kg was required, delivered in 25 kg bags from a nearby warehouse, helping to keep the logistics carbon footprint low. As persulfate requires careful handling, the contractor took all necessary safety measures for storage and handling. Factors such as fire safety and unpredictable summer weather also played a role. From the storage facility the product was transported to an onsite mixing facility. There the bags were opened under controlled conditions, ensuring little physical contact between field technicians and the sodium persulfate. Special attention was focused on reducing the production of any dust particles.

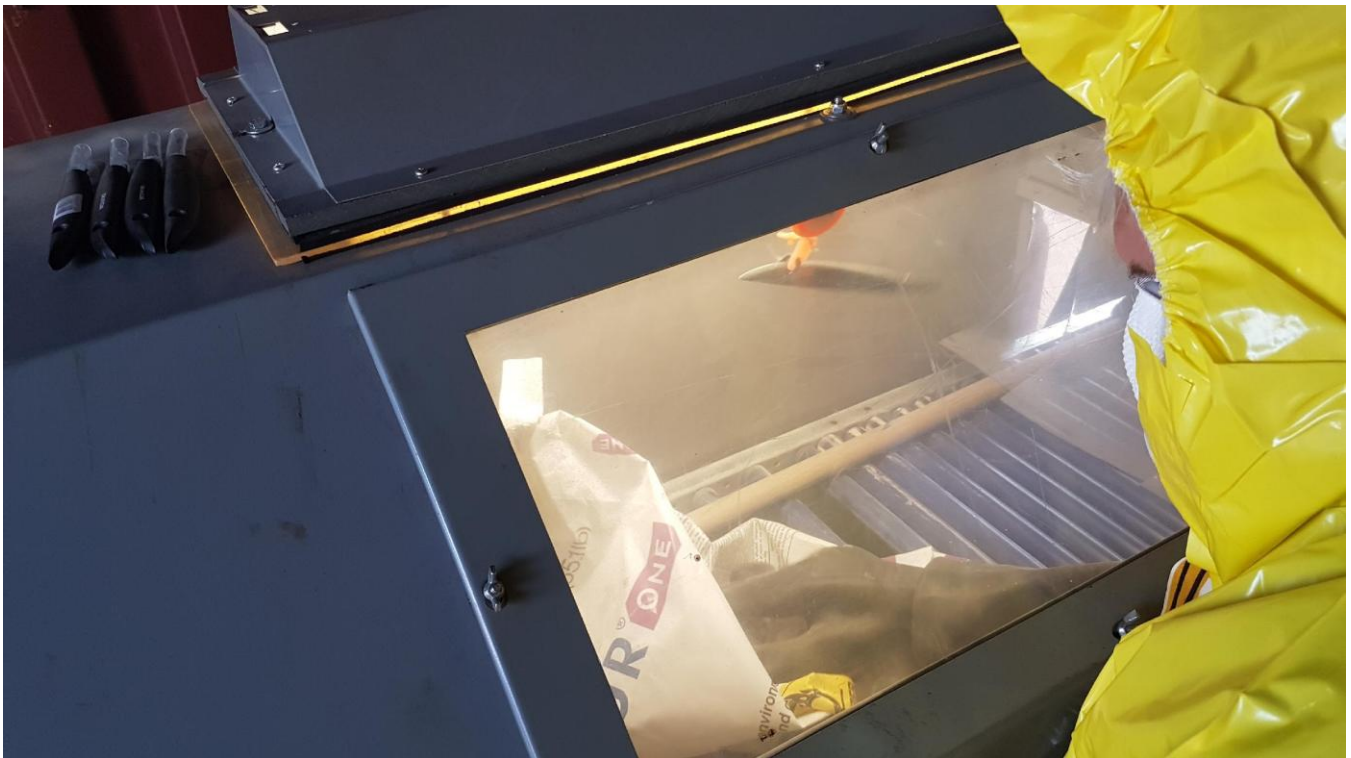

The injections were made per batch, and in the injection plan there are several different concentration batches provided. A typical batch contained 4 m<sup>3</sup> of clean water into which a specified amount of Klozur One was added. From the mixing unit, the proper solution of Klozur One is transferred into the injection tank.



Volgorde aanmaak	Batch Volume [Liter]	Batch Aantal [n]	Klozure-One [kg/batch]	Aantal zakken [25 kg]	Batch conc. [g/l]	Volume per Filter [Liter]	Filters
1	3700	3,00	350	14	94,6	2775	D1, D2, D3, D4
2	4500	4,80	200	8	44,4	3600	M1, M3, M7, M10, M11, M15
3	4500	4,00	200	8	44,4	3600	M2, M4, M8, M13, M14
4	4500	6,00	200	8	44,4	4500	O1, O3, O7, O10, O14, O16
5	4500	6,00	200	8	44,4	4500	O2, O4, O6, O11, O13, O15
6	3600	4,00	350	14	97,2	3600	M5, M6, M9, M12
7	4500	4,00	425	17	94,4	4500	O5, O8, O9, O12
8	4000	4,50	200	8	50,0	3600	M16, M17, M18, M19, M20

### Klozur One batching scheme

As each batch of injectable solution is mixed together, it is then applied to the subsurface through existing injection wells. In total, the contractor used 40 injection points at three different subsurface levels, in a grid pattern with a center-to-center distance of 5 meters (ROI of 2.5 meter)

With this grid, it was possible to engineer contact across the entire source area. At spots with higher concentrations of contaminant, more solution was applied with a higher concentration of persulfate. At each injection points between 2,775 and 4,500 liters of solution were applied. Through use of a manifold system, 4 to 6 wells were worked simultaneously, using a little overpressure to prevent blow-out at the surface. The sequence of the injections was performed from outside to inside located filters. In total, the field works lasted nine days to inject 155 m<sup>3</sup> injection fluid of sodium persulfate.



Overview injection filters in source zone



Detail injection well manifold



## Results

Before the initiation of the injections there was an investigation of the TRI concentrations onsite. Monitoring activities during and after the injections including measurements of pH, oxygen, redox and electrical conductivity. Following the injections with sodium persulfate, there was a notable decrease in pH and increase in electrical conductivity visible. The contractor used Klozur Field Test Kits to determine an indication of the amount of active sodium persulfate still available.



Klozur Field test kits

The parameters were monitored weekly. After four weeks most of the active sodium persulfate was consumed, allowing the monitoring wells to be used for groundwater quality. In total, monitoring was conducted through 10 wells and in all of them the TRI concentration was decreased to below remediation targets. Four weeks later, an independent verification by the engineering consultants confirmed the positive results. They also concluded that there was no active sodium persulfate left and that the trichloroethylene was sufficiently removed.

Monitoring well 2 depth: 4,5 m below ground level	Parameter		06-09-2019	24-09-2019	21-10-2019	21-11-2019
	PER	µg/l	<50	<1	<1	<1
TRI	µg/l	14.000	2,4	<1	<1	<1
CIS	µg/l	<50	1,4	1,4	1,4	1,4
VC	µg/l	<100	<2	<2	<2	<2
Sodium	mg/l	13	n.a.	3.900	2.600	2.600
Sulfate	mg/l	30	n.a.	1.300	1.400	1.400

Analysis overview of MW2 as representative data

In total the chemical oxidation removed 99.6% of the TRI pollution. With this good result we were able to close the active remediation phase.

### 4.3 Injection type

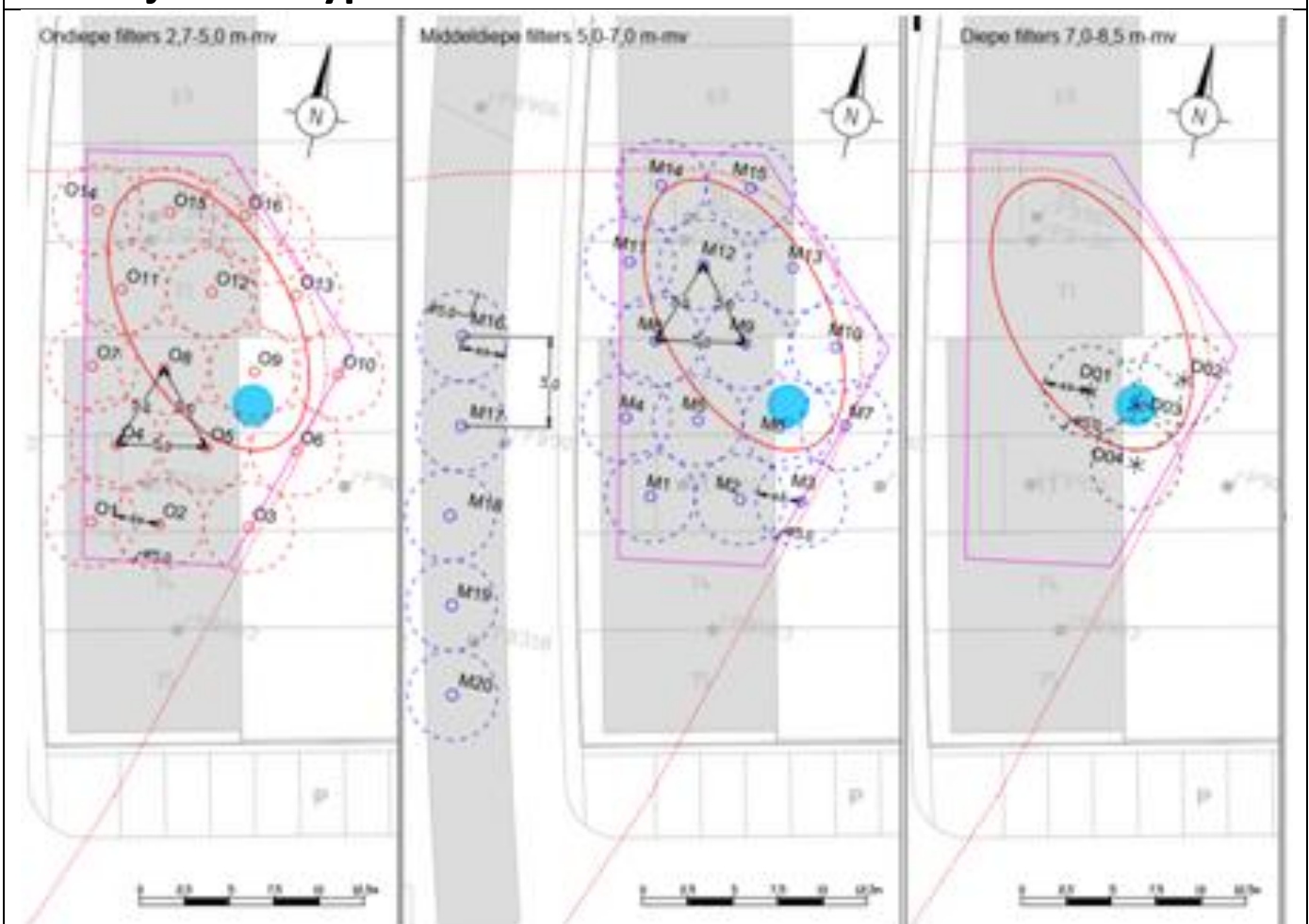

Within the source zone area of 270 m<sup>2</sup> a total of 35 injection wells were installed. The



injection wells in the source zone were spaced in grid formation with a distance of 5.0 meter. Downstream the source zone another 5 injection wells were installed in barrier formation. For the injection we installed new fixed injection wells with a diameter of  $\varnothing 50$  and a screened length of 2 meter.

The injection wells were installed with a screened interval 2.7-5.0 mbs, 5.0-7.0 mbs and 7.0-8.5 mbs. In order to prevent preferential flow or blow-outs every injection filter had a fixed clay-stop was grouted with cement/bentonite up to the surface.



With this grid, it was possible to engineer contact across the entire source area. At spots with higher concentrations of contaminant, more solution was applied with a higher concentration of persulfate. At each injection points between 2,775 and 4,500 liters of solution were applied. Through use of a manifold system, 4 to 6 wells were worked simultaneously, using a little overpressure to prevent blow-out at the surface. The sequence of the injections was performed from outside to inside located filters. In total, the field works lasted nine days to inject  $155 \text{ m}^3$  injection fluid of sodium persulfate.

## 4.4 Radius of influence

The radius of influence (ROI) was based on expert judgement. The actual injection radius of influence is monitored during the first injections. In this way, the ROI and the amount of injection volume for each injection filter was validated in the field.

<b>7. Injection design</b>		
	Lengte	22 m
	Breedte	12,5 m
	Permeability	5 m/day
	Vw	0,91 m/month
	Interval	1 month
		0,91 m
	h.o.h.	5 m
	Design ROI	2,5 m
	Injection ROI	2,05 m
	Design AOI	19,63 m <sup>2</sup>
	Injection ROI	13,14 m <sup>2</sup>
	overlap	15%



## 4.5 Control parameters

Before injection we monitored the natural field conditions in control monitoring wells:

- pH, temperature, dissolved O<sub>2</sub>, redox potential, electrical conductivity, Sodium, Sulfate, Chemicals of concern

During injection we monitored the dispersion in the field in monitoring filters:

- pH, temperature, dissolved O<sub>2</sub>, redox potential and electrical conductivity,
- injection pressure was monitored on each injection well

After injection we monitored the dispersion and contaminant in monitoring filters:

- pH, temperature, dissolved O<sub>2</sub>, redox potential and electrical conductivity,
- Klozur Field Test Kits were used to determine an indication of the amount of active sodium persulfate still available.

The parameters were monitored weekly. After four weeks most of the active sodium persulfate was consumed, allowing the monitoring wells to be used for groundwater quality. In total, monitoring was conducted through 10 wells and in all of them the TRI concentration was decreased to below remediation targets. Four weeks later, an independent verification by the engineering consultants confirmed the positive results.

## 5. Full-scale application

### 5.1 Main Reagent

The first injection round of injecting 9,225 kg of activated persulfate Klozur One (155 m<sup>3</sup> of solution) proved to be enough to reach the target values. No rebound occurred.

## 7. Additional information

### 7.1 Lesson learnt

We had limited time to reach our target values (2 months). As we had a low % of organic matter, we chose to perform a full-scale pilot instead of a laboratory batch test. This way we determined the amount of oxidant needed in the field (first injection round).



Eventually we would have had time to inject a second time, but this wasn't necessary anymore as we reached the target values after the first injection.  
This way we have saved time and money.

### **7.3 Training need**

The human safety regulations and creating a safe working process for the operating personnel have to be taken into account when applying this technique.  
This includes the whole cycle of storage of the oxidant, handling, dust control, mixing and finally controlled injection.

## 1. Contact details - CASE STUDY: ISCO n.12

<b>1.1 Name and Surname</b>	Valentina Sammartino Calabrese
<b>1.2 Country/Jurisdiction</b>	Italy
<b>1.3 Organisation</b>	ARPA Campania
<b>1.4 Position</b>	Public servant - expert in site remediation
<b>1.5 Duties</b>	
<b>1.6 Email address</b>	<a href="mailto:v.sammartino@arpacampania.it">v.sammartino@arpacampania.it</a>
<b>1.7 Phone number</b>	+39 081 2301957

## 2. Site background

### 2.1 History of the site: Challenges and Solution

- The site is located in an area of medium population density and of important naturalistic / archaeological value.
- It is part of a former SIN
- The company operates and produces in the defence, aerospace and security sectors.







## 2.2 Geological and hydrogeological setting

In particular in the north-eastern portion of the site, where the ISCO technology was applied, the surface geological structure can be described by the following scheme:

- 0 - 0.60 m: ground floor including the underlying substrate composed of mixed inert material;
- 0.60 - 1.50 m: fill material composed of inert material mixed with a high permeability silty sand matrix;
- 1.50 - 4 m: fine sands, slightly clayey, of fluvio-lacustrine origin, high permeability;
- 4 - 9 m: coarse pumice and gray sands.

The water table has a depth ranging from about 1.5m to about 2 m from the ground level and is located in the alluvial lake deposits.

## 2.3 Contaminants of concern

- Soils:
  - Hydrocarbons: 3500 mg / Kg
- Groundwater
  - Benzo(a)anthracene: 7.6 µg / L
  - Pyrene: 29 µg / L
  - Benzo(b)fluoranthene: 4.2 µg / L
  - Benzo(g,h,i)perylene: 2.2 µg / L
  - Polycyclic Aromatic Hydrocarbon (PAH sum): 10 µg / L
  - Tetrachlorethylene: 50 µg / L
  - Trichloroethylene: 5.4 µg / L
  - Vinyl chloride: 4.1 µg / L
  - Benzene: 27 µg / L
  - Xylene: 133 µg / L
  - Toluene: 22 µg / L

## 2.4 Regulatory framework

National Regulations (D.Lgs. 152/2006)



## 3. Laboratory-scale application in field

### 3.1 Laboratory scale application

Scope of lab test:

- determine the amount of oxidizing reagent (SOD), for the two different oxidizing compounds tested (sodium permanganate or percarbonate), necessary for the oxidation of organic and inorganic pollutants present in the solid, liquid phase and in the saturated biphasic mixture.
- verify the reduction of pollutant concentrations using different stoichiometric ratios with respect to the SOD determined for each of the two oxidizers analyzed.

#### 2. Lab scale test description:

The SOD determination tests were performed by preparing, for each reagent tested, 5 test tubes each containing an aliquot of 10 g of soil, kept stirred at 120 rpm at room temperature. The reagent solutions were added to the test tubes at three different concentrations. In order to verify reproducibility, the tests were performed in duplicate for each sample.

Reagent quantities for each test tube were calculated on the basis of samples TOC content and of similar experiences reported in the literature.

In total 6 tests were performed in duplicate at different stoichiometric ratios. The liquid / solid ratio used, based on literature reference data, was 3: 5.

During each test, lasting 8 days, the residual oxidant content was determined on a daily basis: for permanganate by means of a spectrophotometric absorption method at 520 nm, whereas for percarbonate by titration with permanganate. To evaluate the influence of the contamination on SOD, the determination of SOD was also carried out on a clean soil sample with the same procedure. Subsequent to the determination of the SOD, ISCO tests were carried out on soil saturated with groundwater using three different concentrations of oxidant in stoichiometric relation with respect to the SOD (ratios of 1: 1, 1: 3 and 1: 5) for two different times (24h and 72h). Consequently, 4 series of tests were carried out, one of which without the addition of oxidant, to check the quantities of pollutant volatilized in different test conditions.

At the end of these tests, the oxidant residual quantity was determined, and in particular metals, C<sub>>12</sub> and PAHs were determined in the solid phase, whereas metals and chlorinated solvents were determined in the liquid phase.

The results of the tests conducted showed:

- In regards to the solid fraction: a marked reduction in total hydrocarbons C<sub>>12</sub>, in



the case of using permanganate, even with a low stoichiometric ratio (1:1). The same efficiency was not achieved by percarbonate. A significant reduction in PAHs in the case of using permanganate with stoichiometric dosages greater than 1:3; the use of permanganate in a stoichiometric ratio 1:1 and percarbonate had instead shown unsatisfactory results.

- With respect to the liquid fraction, the analytical results show: CrVI below the instrumental detection limit after 72h of testing or at the end of the reaction control period, either in the slurry where permanganate was used, and in those where percarbonate has been used; complete oxidation of TCE and PCE when using sodium permanganate.

On the basis of the tests carried out in the laboratory, it has been highlighted the necessity to provide a dosage of reactive, to reduce the pollutants present, much higher than the pure stoichiometric ratio between the moles of oxidant and those of pollutant.

## 4. Pilot-scale application in field

### 4.1 Main treatment strategy

The laboratory tests showed that, due to the type of pollutants present, the most performing oxidant is permanganate, with percentages of pollutant reduction ranging from 40-50% up to about 90%.

The test consisted in the controlled injection of a solution consisting of:

- 2000 litres of industrial water
- 207.2 kg of sodium permanganate solution with a 40% concentration, corresponding to approximately 85 kg of permanganate.

The injection of the solution was carried on at a flow rate of about 15 l/min (0.9 m<sup>3</sup>/h) in order to minimize disturbance to the aquifer and avoid displacement of the contaminated water.



### 4.3 Injection type

To improve monitoring of the possible reagent downstream by migration, an additional control piezometer and a well (PE) were installed to recover any residual permanganate. Before the pilot scale application, in order to evaluate the migration routes of the injected solution, a test with fluorescein was performed. The test involved the controlled injection of a known volume and concentration solution (4000 liters of groundwater and about 0.4g of fluorescein), followed by monitoring of its propagation on a regular daily basis.

This test showed that despite the significant flow rates, the quantities of fluorescein recovered were equal just to approximately 30% of those injected, thus indicating minimal "migration" of the tracer.

The thickness of the saturated soil involved in the test was approximately 6.5m, from 1.5m up to approximately 8m below ground level. The pilot field consisted of: 1 injection well, 5 wells placed radially around the injection well, at a distance of 3, 5, 7 and 15m (internal control piezometers), and 6 external control piezometers/wells.

### 4.4 Radius of influence

The observation of the water colour in the piezometers adjacent to the injection point made it feasible to verify the solution distribution in the soil. The distinctive purple colour of the injected oxidant was found in the injection well alone, indicating that the reagent reacted completely before it could migrate downstream. Thus the reaction rate is higher than the rate of oxidant dispersion.

Field tests conducted by injecting an amount of sodium permanganate equal to 86 kg showed a radius of influence of less than 2 m, with a total consumption of the injected reagent over a few days.



## 4.5 Control parameters

During field monitoring the following measurements were carried out:

- A check of the groundwater colour in all points of the cell for 3 days (72 hours);
- groundwater sampling in all the cell points for analysis of metals (Fe, Mn, Cr (III) and Cr (IV), As), chlorinated solvents, IPA, total hydrocarbons, BTEX and COD, CO<sub>2</sub>. During the sampling operations, the chemical-physical parameters were also measured after 1 day (T1), 10 days (T2), and 30 days (T3) from the injection.

The physic-chemical data collected during the sampling phases showed significant variations in the redox potential.

The chemical results showed an average percentage concentration reduction after 24 hours equal to 83%. In the following surveys (carried out after 8 days and after 1 month) the concentrations increased, but did not reach the values measured before the pilot test.

## 5. Full-scale application

### 5.1 Main Reagent

The laboratory tests and the pilot test highlighted the requirement for a higher dosage of permanganate than the dosage corresponding to the simple stoichiometric ratio, calculated with reference to SOD.

With permanganate, both the laboratory tests and the pilot field test showed a percentages of pollutant reduction of ranging from 40-50% up to about 90%.

### 5.3 Injection type

Considering the strong anisotropies, the most suitable and least impacting approach for the activities of the site involved injecting the oxidant mixture through a system of micro-perforations at different depths. In order to prevent reagent migration to the hydraulic barrier, wells had been created a few meters upstream of barrier itself, activated in the case of detection of unreacted permanganate (change of groundwater colour).

Considering the high consumption of oxidizer and the low radius of influence (less than 2m), in order to minimize the injection volumes per single point, 48 perforations were carried out (diameter of 127mm and a maximum depth of 7m) for the injection of the oxidizing compound. The drilling took place with continuous dry core drilling. In every perforation, two 1" PVC pipes were installed at different depths. The perforations were arranged along a regular 4 m side mesh with a thickening in the most impacted area, the distance between two injection points is about 2.5 m. A total of 48 injection clusters were created.

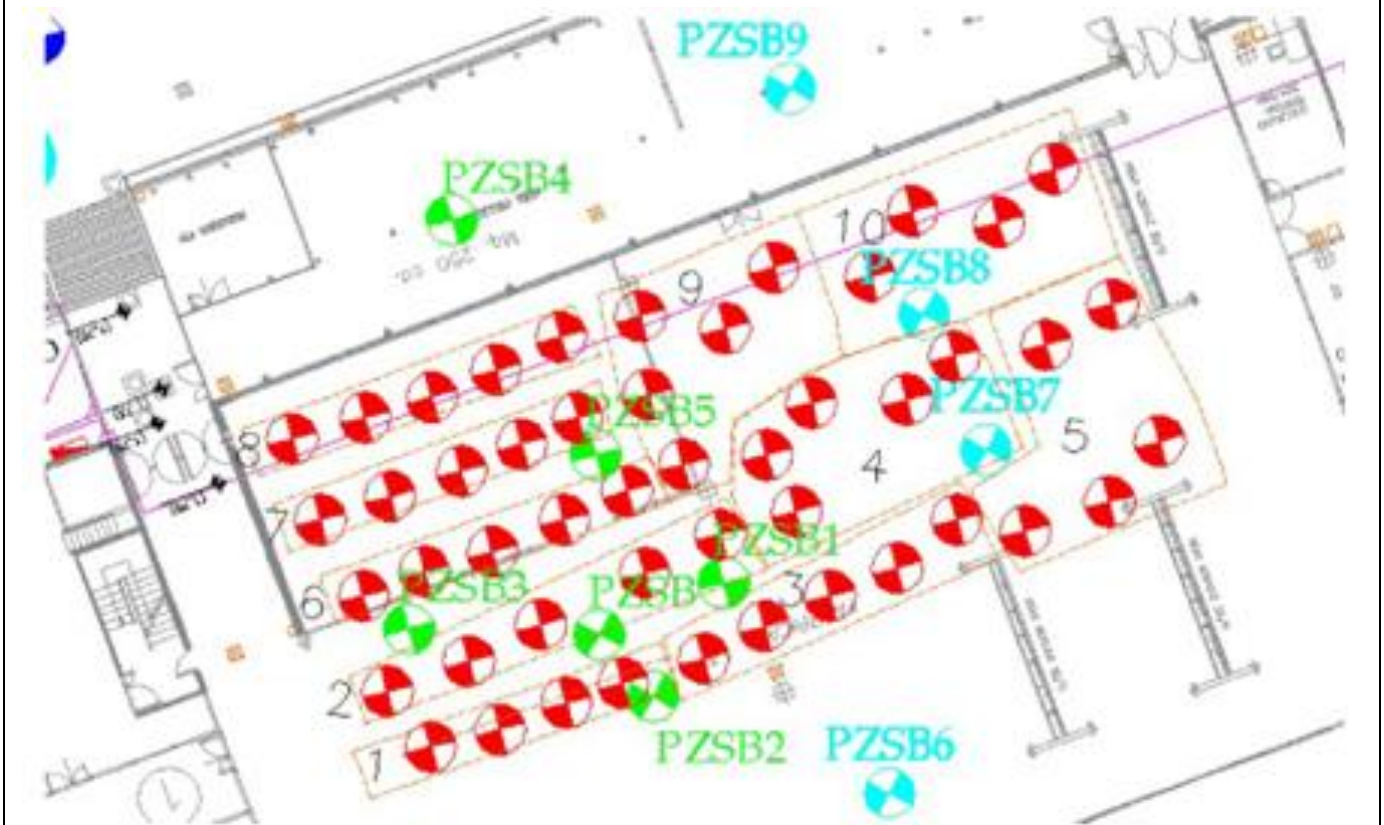



## 5.4 Radius of influence

Field tests enabled the estimation of a radius of influence of 2m or less with a total consumption of the injected reagent in few days as shown by water colour variation in the injection point.

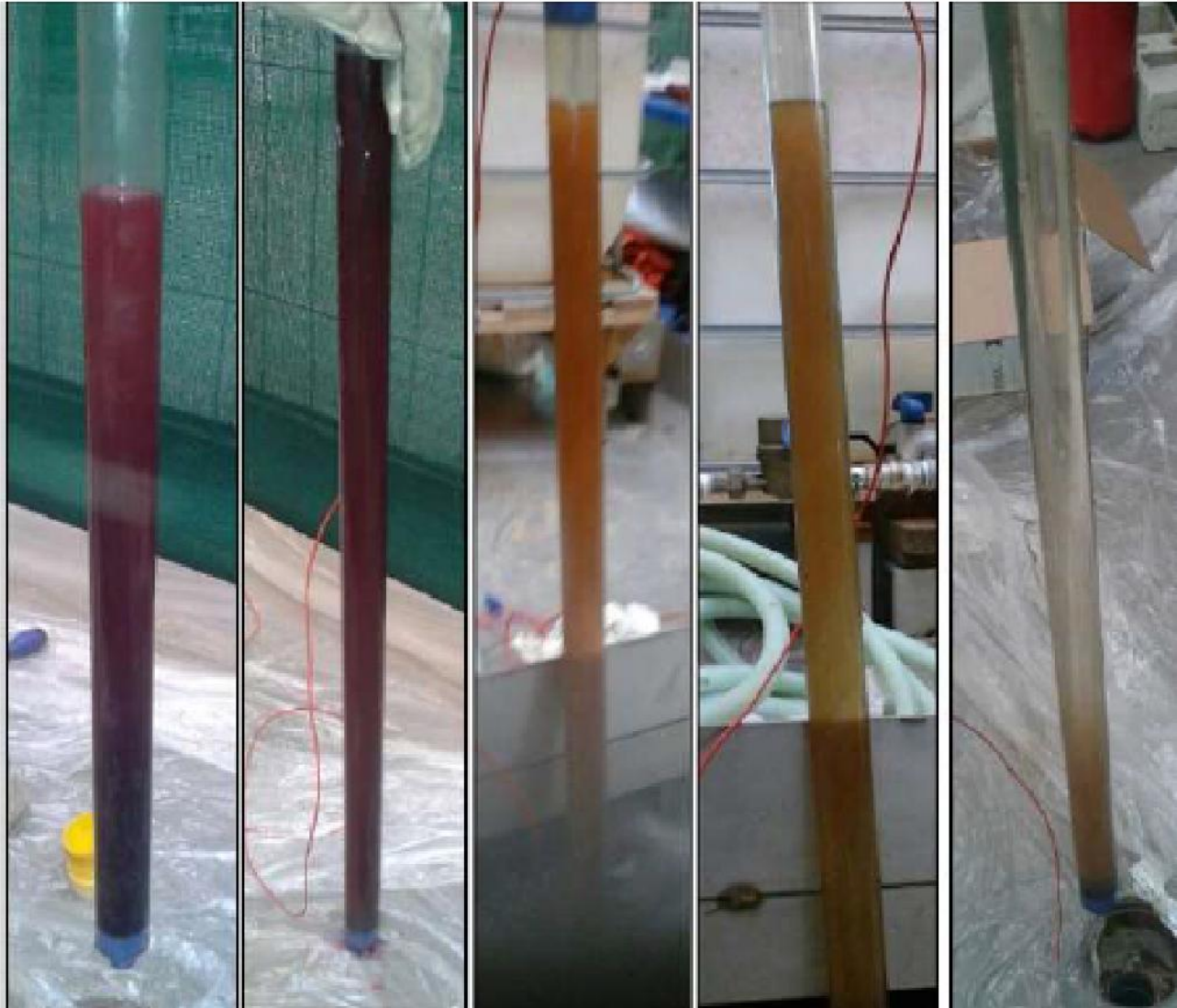



## 5.5 Process and performance monitoring

In addition to the 5 monitoring points of the pilot project phase, further 4 control points were installed.

- Before injections, in all the existing piezometers, the following parameters were measured at different depth using a multiparametric probe: temperature, dissolved oxygen, pH, conductivity, redox potential and salinity;
- During the injection phase all the piezometers were monitored in order to assess the propagation of the oxidation conditions;
- After the injections, all piezometers were monitored on a daily basis for the first 3 days in order to assess the propagation of the oxidation conditions following the injections.

## 6. Post treatment and/or Long Term Monitoring

### 6.1 Post treatment and/or Long Term Monitoring

After ISCO application all piezometers were monitored on a daily basis for the first 5 days, verifying oxidant traces and pollutants concentrations.

Then sampling surveys were carried out once a week for 1 month to check the content of: manganese, chlorinated solvents and polycyclic aromatic hydrocarbons

A long term monitoring was carried out to verify the fulfilment of remediation goals: Bi-annual monitoring of piezometers at quarterly frequency for the first year and then every six months.

The parameters analyzed during the biannual monitoring are: PAH, chlorinated solvents, BTEX, total hydrocarbons, Metals (Mn, Cr (VI), Cr (total)).

## 7. Additional information

### 7.1 Lesson learnt

Presence of buildings or underground services was a limiting factor for the application of this remediation technique.



## 7.3 Training need

Training course on transport models in groundwater.

## Glossary of Terms

<b>Term (alphabetical order)</b>	<b>Definition</b>
PRB	Permeable Reactive Barrier
SOD	Soil Oxidant Demand
SIN	Sito di Interesse Nazionale (National Interest Megasite)

## 1. Contact details - CASE STUDY: ISCO n.13

<b>1.1 Name and Surname</b>	Puricelli Sara, Marin Rosa Angela, Ricci Diego, Confalonieri Massimiliano
<b>1.2 Country/Jurisdiction</b>	Italia
<b>1.3 Organisation</b>	ARPA Lombardia
<b>1.4 Position</b>	
<b>1.5 Duties</b>	
<b>1.6 Email address</b>	<a href="mailto:s.puricelli@arpalombardia.it">s.puricelli@arpalombardia.it</a> ; <a href="mailto:m.confalonieri@arpalombardia.it">m.confalonieri@arpalombardia.it</a>
<b>1.7 Phone number</b>	+39 031 2743913

## 2. Site background

### 2.1 History of the site: Challenges and Solution

The industrial site in question is located in Northern Italy within an area subject to archaeological and hydrogeological constraints, in the vicinity of an important surface water body (which passes 250 m downstream of the site). The site occupies an area of approximately 63,000 m<sup>2</sup>, of which approximately 50% is occupied by buildings (currently for non-productive use, but intended for the provision of services) and the remaining part used for parking and green areas.

The characterization highlighted a significant contamination by organohalogen solvents for the groundwater in the southern area of the site. This site corresponds to the area used for the storage of waste containing chlorinated solvents - used in degreasing and painting laboratories - on which degraded barrels are also located.





There are no specific protocols for the management of this site, but the control and technical evaluation activities in support of the Municipality (proceeding administration appointed by the Region for the management of contaminated sites) are carried out by ARPA. ARPA is the Environmental Protection Agency established in 1999 that deals with the prevention and protection of the environment, supporting regional and local institutions in multiple activities including:

- atmospheric pollution;
- noise pollution;
- water protection for surface water and ground water
- monitoring electromagnetic fields
- investigations on soil contamination and remediation processes.

The remediation activities through injection were carried out in the period between the 4th till 21st September 2012.

## 2.2 Geological and hydrogeological setting

The investigations carried out at the site revealed the presence of a semi-confined aquifer with a silty clay substrate (with low permeability at about 30-32 m from ground level and groundwater level at -6m. In the source of contamination area, which was subjected to ISCO, the saturated matrix had a thickness from -12m to -37m.

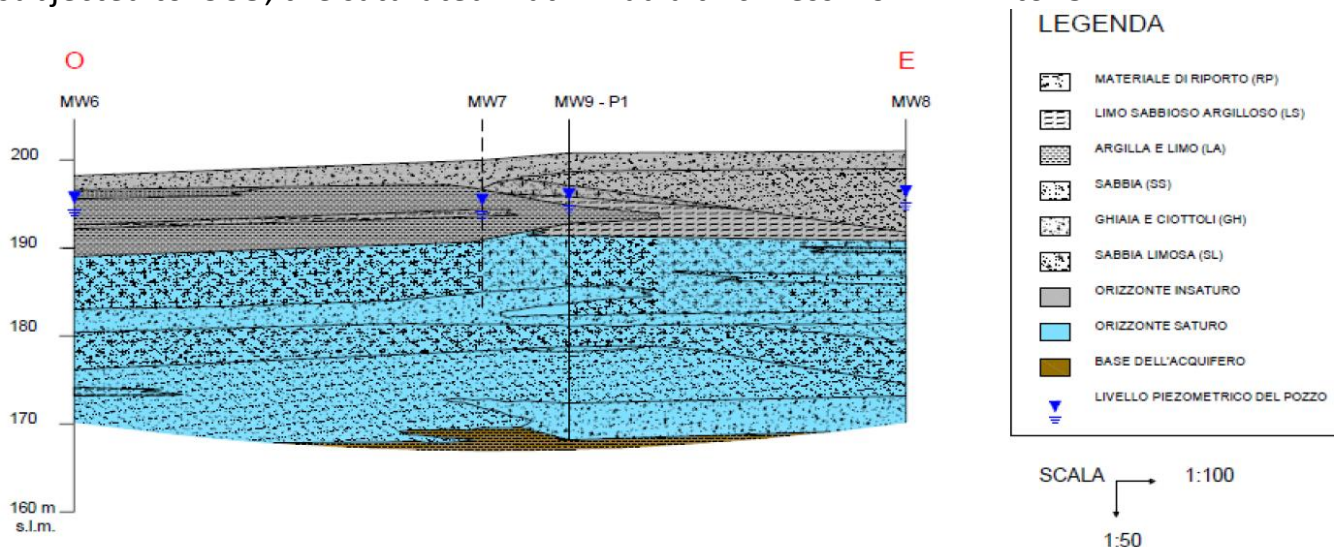

The local outflow of the aquifer is E-W in the portion of the site involved in the intervention. The average hydraulic gradient is equal to 0.5% and the permeability varies from  $4.4 \times 10^{-5}$  m/sec to  $5.5 \times 10^{-5}$  m/sec, the flow rate of the groundwater has been calculated equal to about 40 m/year.





In order to acquire more detailed information for the preparation of the remediation project, regarding the extent of contamination, an investigation was carried out using MIP (Membrane Interface Probe) consisting of 10 drilling points pushed to a depth of 35 m below ground surface thus being able to evaluate an area of about 175 m<sup>2</sup> around the MW8 piezometer.

## **2.3 Contaminants of concern**

The environmental characterisation study was performed in 2001, from which, chlorinated solvents with concentrations in groundwater equal to approximately 3,000 µg/L were identified. The main contaminants detected were, in the order of concentrations found, PCE and, alternatively, TCE, 1,1 dichloroethylene. There was no evidence of the presence of the free product (DNAPL for chlorinated products) which is denser than the water to be sought at the base of monitoring piezometers.

Unsaturated soils in the same area did not show contaminant values higher than the CMA (Maximum Permissible Concentrations) established by the then current Ministerial Decree 471/99, also because it had been the subject of an EVS intervention.



## 2.4 Regulatory framework

The proceeding was conducted according to Ministerial Decree 471/99 as the proceeding was initiated in 2001, before the entry into force of Legislative Decree 152/2006.

Following the finding of values higher than the CMA, the preliminary remediation Project was presented to define all the suitable and economic sustainable remediation methodologies useful for the site. The EVS intervention was selected for the unsaturated and a direct oxidation technology in situ (ISCO) with  $\text{KMnO}_4$  for the saturated. This also involved the execution of appropriate laboratory tests and a pilot test in situ.

An emergency safety intervention was also carried out on the aquifer, through the construction of a hydraulic barrier to avoid the migration of contaminants downstream.

The ISCO treatment was performed in accordance with the technical indications provided in Protocol No. 28220 of 20/07/2005 prepared by APAT (now ISPRA) for the application of chemical oxidation in situ.



## 3. Laboratory-scale application in field

### 3.1 Laboratory scale application

The purpose of the tests was to evaluate the PNOD (Permanganate Natural Oxygen Demand) parameter which represents the natural oxidant requirement for permanganate; i.e. the amount of permanganate necessary for the oxidation of organic and inorganic compounds naturally present in the soil.

Four soil samples and two groundwater samples were taken from the source area, for the batch tests carried out independently by the operator. PNOD was found to vary between 1 and 7 kg  $\text{KMnO}_4/\text{m}^3$  soil as a function of the depth of the soil.

For the design, an average concentration of organohalogen compounds equal to 2 mg/l was considered; the stoichiometric  $\text{KMnO}_4$ /contaminated ratio of 3.



## 4. Pilot-scale application in field

### 4.1 Main treatment strategy

In choosing the remediation technology, due consideration was placed for the presence of low permeability horizons that made more traditional techniques, such as Air Sparging, unfeasible.

Pharmaceutical grade Potassium permanganate ( $\text{KMnO}_4$ ) was used in a 3% solution, with a maximum content of impurities such as to allow the injection of a solution that complies with the quality requirements of the Ministerial Decree 471/99 with the obvious exception of the manganese parameter.

For permanganate (sodium or potassium), the half-reaction of reduction in the typical conditions of the subsoil with pH between 3.5 and 12 is as follows:

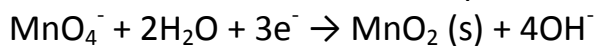

The manganese dioxide  $\text{MnO}_2$  that is formed is an insoluble solid that is even used as a filter medium for the reduction of manganese concentrations from groundwater, therefore non-toxic and already known in remediation procedures. Manganese dioxide precipitates as a particle or as a colloid. As a result, the application of permanganate, at the end of the oxidation reactions, does not result in an increase in the concentrations of dissolved manganese.

Below are the oxidation reactions of the two main contaminants found in the groundwater:

*Perchloroethylene (PCE):*



*Trichloroethylene (TCE):*



Before the injection, a zero-time monitoring campaign was carried out, at T0, to be considered as a reference before carrying out the ISCO injections.

### 4.3 Injection type

The 2004 field pilot test was conducted with injection wells to allow greater flexibility during injections and sampling.

Three PVC injection wells with a diameter of 3" (IW1-A, IW1-B and IW1-C) made *ad hoc*, located at the vertices of a triangle, slotted respectively (slot 1 mm) in the following intervals: 25 -30m, 18-25m, 12-18m. In addition, three monitoring wells (MP2-A, MP2-B and MP2-C) were made with slits in the same intervals as those of injection. A plan of the pilot plant is shown in the figure below.

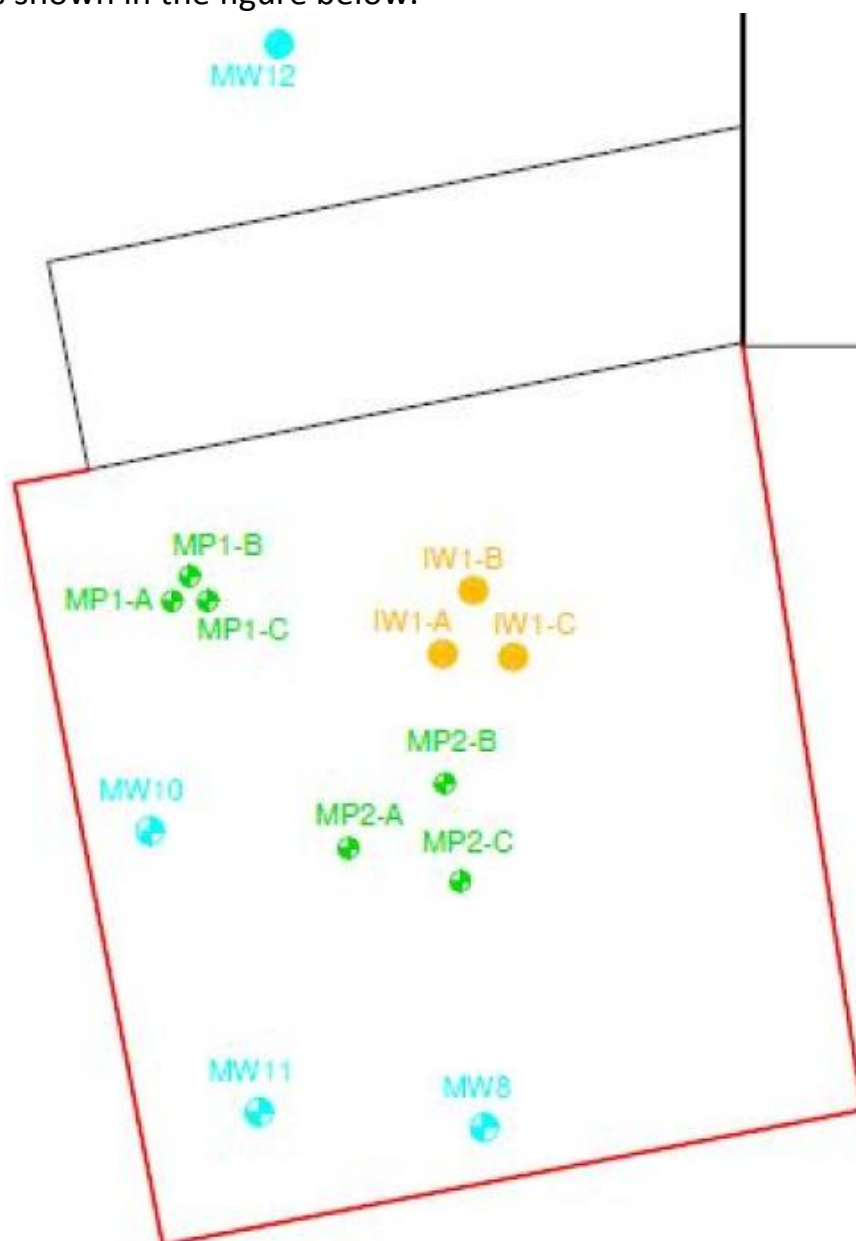

350 kg of permanganate were injected on the deep and intermediate intervals and 375 kg on the surface, in a single campaign, using the structures outlined below.

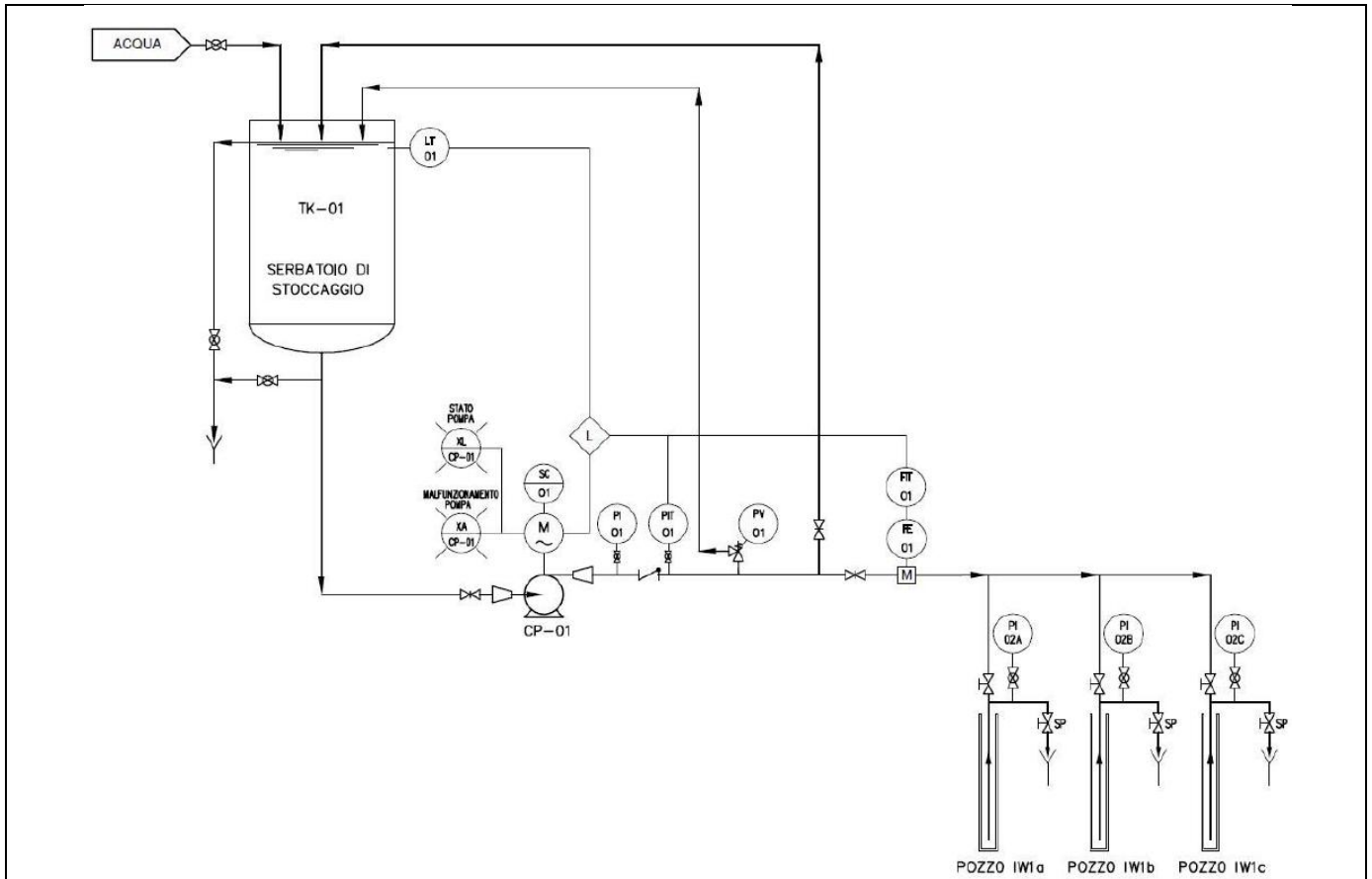

Finally, a photograph of the pilot plant is shown in order to demonstrate the scarcity of impact, compatible with an activity in operation.







## 4.5 Control parameters

The control parameters concerned the monitoring of the compounds of interest of any oxidation by-products and the recording of physical parameters with a multiparametric probe, with particular attention to the redox potential and conductivity.

In general, the concentrations of organohalogen compounds rapidly decreased, even below the detection limit, and then sometimes increased again, usually to much lower values than the initial starting concentration, in the latest monitoring campaigns. This phenomenon can be explained by the spatial and temporal limitation of the intervention which had evidently not completely eliminated the secondary source of contamination in the soil (as confirmed by the preliminary MIP investigations). The most relevant PCE concentrations remained confined to downstream-flow control piezometers.

Concentrations of TCE generally decreased, albeit to a lesser extent than PCE.

In the triplet of injection piezometers, the redox potential remained stabilized around 500 mV. The conductivity values initially increased at all points, with values of the order of  $10^3 \mu\text{S}/\text{cm}$  at the injection points.

During the pilot test, no accumulations of organohalogen compounds with a low number of chlorine atoms (dichlorethylene and vinyl chloride monomer) or of other secondary organohalogen compounds were observed. This indicated that the oxidation of the organohalogen compounds was complete and that there was no risk of accumulation of compounds with a lower number of chlorine atoms.

## 5. Full-scale application

### 5.1 Main Reagent

$\text{NaMnO}_4$  was used as an alternative to the  $\text{KMnO}_4$  used during the pilot scale test for operational needs, as it is more cost-effective, more soluble and with the advantage of using smaller injection volumes.

The reactivity of the two species is identical as the active ion is always the permanganate ion, with the only change being the dosage for the different molar weights.

The criteria for selection between the two salts was based on the greater ease of using a liquid instead of a solid and on the difference in cost. It should also be noted that the use of a solution presents fewer health and safety problems as the handling takes place entirely in the liquid phase without the emission of dust.

Below is a diagram of the injection systems of the oxidizing reagents which highlights the greater simplicity of management of sodium permanganate.

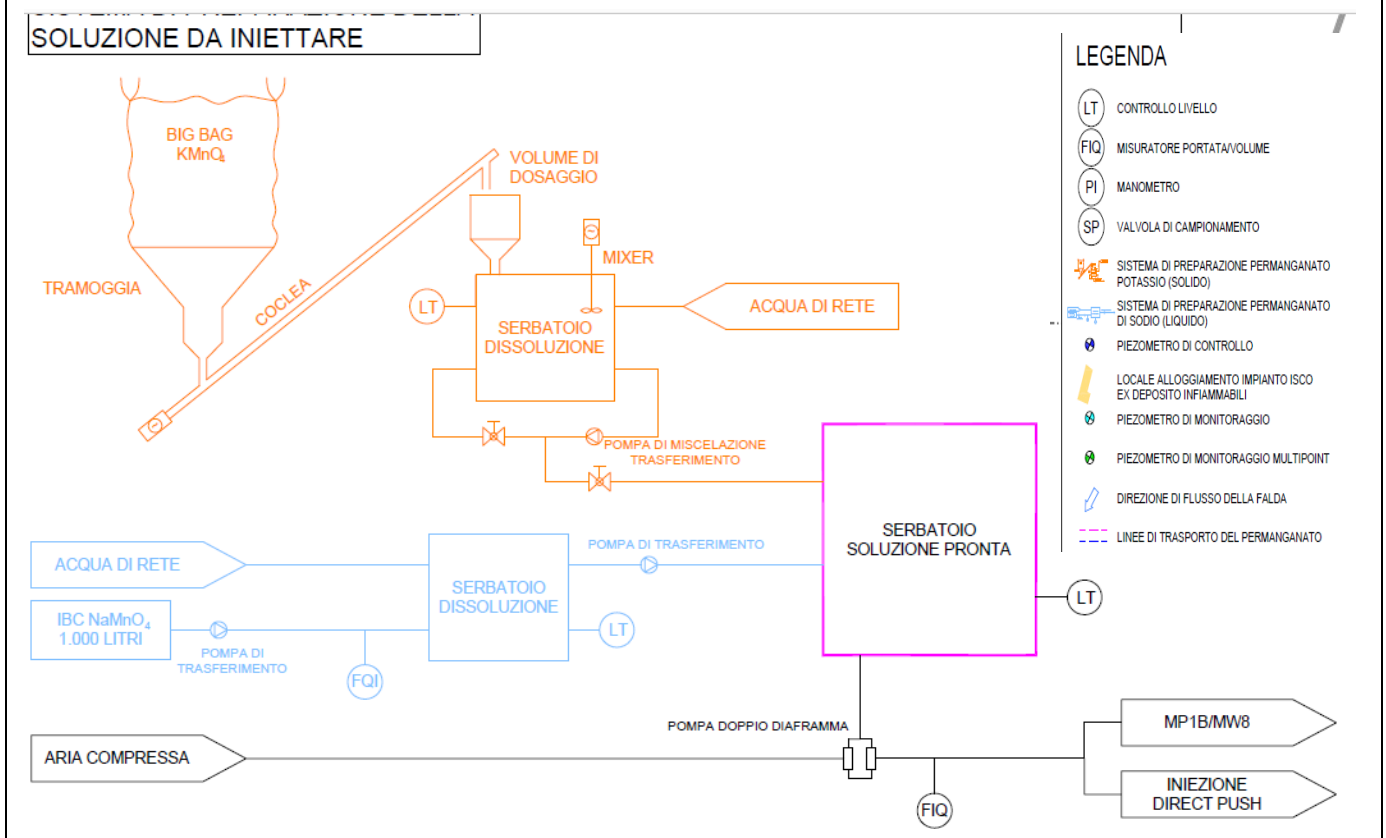

## 5.3 Injection type

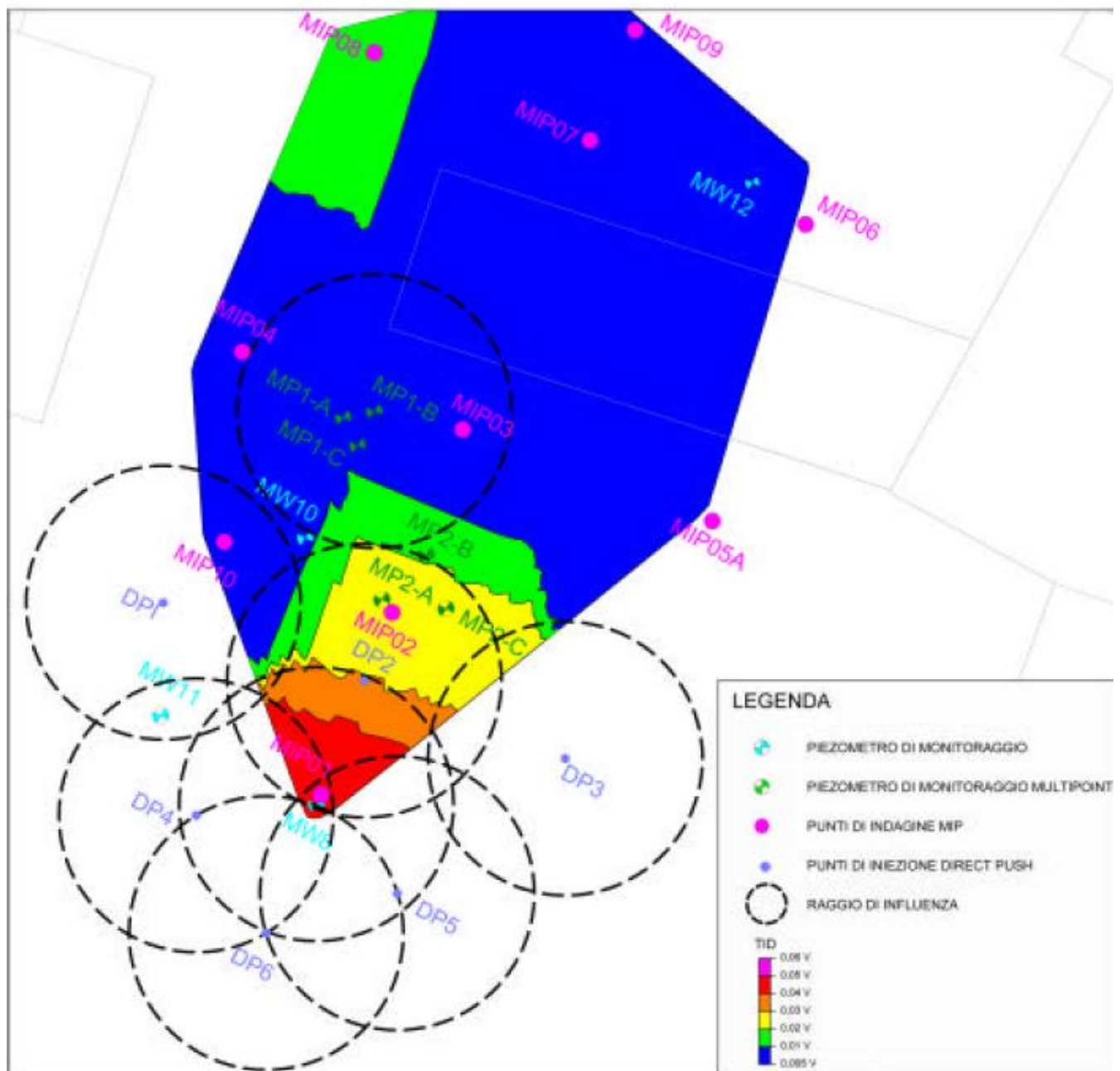

Injection points

The treatment, from the Reclamation Plan (PdB) included:

- The construction of 6 injection points in the area with the greatest contamination (around MW8), identified by the initials DP1 ÷ DP6, with permanganate injection with direct-push technology, at depths between 12 m and 37 m below ground surface;



- direct injection of permanganate into existing MW8 and MP1b piezometers;
- construction of an ad hoc monitoring piezometer (MW13) located downstream of the area subjected to reclamation, equipped with a barrier well, in compliance with the indications of the APAT 2005 Protocol, to be activated in the event of the presence of unreacted permanganate, with re-entry of the same in the MW12 piezometer located upstream of the treated area, creating a closed circuit that also acted as a barrier.

A continuous monitoring system was installed on this piezometer, consisting of a parametric probe aimed at determining the redox potential, associated with an alarm system that would allow, in the event of an anomaly or a potential leakage of the oxidizing agent, the immediate activation of the pumping activity.

Considering the need to inject at different depths, on considerable thicknesses with volumes of complex geometry, the "direct push" methodology was used, which allowed better dosing of the reagents using closer injection points with lower costs than those of injection wells.

A Geoprobe type probe was used, through injections in the 3 intervals -12-16 m; -16-25 m; -25-37m from p.c., also monitoring of the volumes injected was carried out.

The volume of land to be treated, at the design level, was estimated to be 4,648 m<sup>3</sup>, equivalent to approximately 7900 t, for which a quantity of KMnO<sub>4</sub> equal to 17973 kg was used, considering all the organic substances present in the soil on the basis of laboratory tests.

In addition to the piezometers from the PdB, an additional injection point (DP7) was also created for the injection of permanganate and the MW10 piezometer was also used, due to the poor filtering capacity of the piezometers which tended to disperse the reagent very slowly, slowing down injection operations.

We proceeded with a first dose of 20207 kg of NaMnO<sub>4</sub> equal to 9000 kg of permanganate (50% of the requirement), reserving the right to integrate this requirement later; being in solution at 40% by weight, this mass corresponded to an overall volume to be injected equal to 128 m<sup>3</sup> of solution.

Compared to the design data, the volumes of injected permanganate have been modified, mainly due to the lithological nature, represented by very compact silt in the deeper horizons.

The injection pressure was always lower than 6 bar, thus avoiding macro-fracturing of the aquifer.







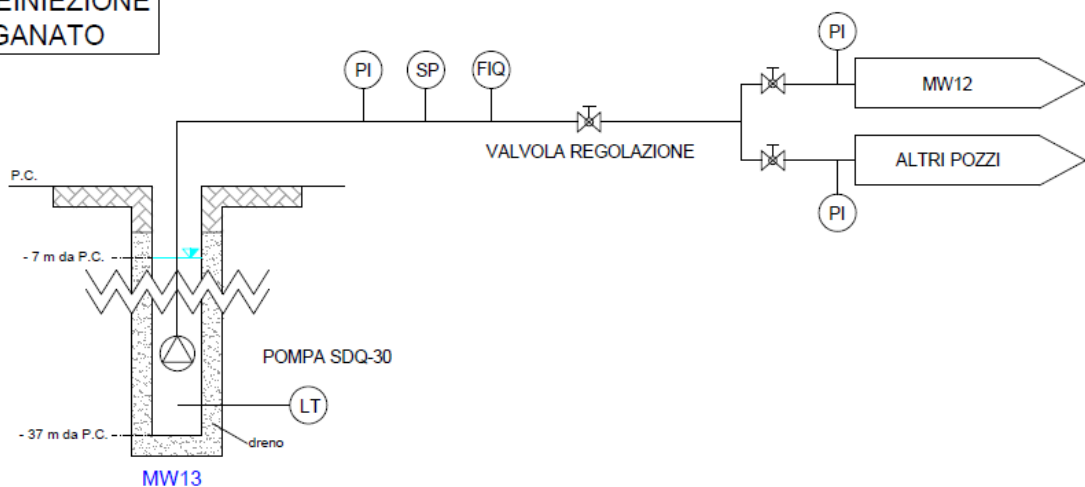





In order to control the possible migration of groundwater containing unreacted permanganate downstream from the hydrogeological area of the intervention area, a

control piezometer (MW13) was created which was pumped when the water present in the piezometer itself showed a violet colour (index of the presence of unreacted permanganate); the extraction was interrupted when the presence of permanganate was no longer visually detected and in any case before the test was carried out. The water extracted from MW13 was re-injected into the monitoring wells present inside the intervention area (in MW12 upstream of MW13) in order to fully exploit the extracted reagent and to create a dynamic treatment cell improving the distribution of oxidant, according to the system specified below.

### SISTEMA DI REINIEZIONE DEL PERMANGANATO



### LEGENDA

-  CONTROLLO LIVELLO
-  MISURATORE PORTATA/VOLUME
-  MANOMETRO
-  VALVOLA DI CAMPIONAMENTO
-  SISTEMA DI PREPARAZIONE PERMANGANATO POTASSIO (SOLIDO)
-  SISTEMA DI PREPARAZIONE PERMANGANATO DI SODIO (LIQUIDO)
-  PIEZOMETRO DI CONTROLLO
-  LOCALE ALLOGGIAMENTO IMPIANTO ISCO EX DEPOSITO INFIAMMABILI
-  PIEZOMETRO DI MONITORAGGIO
-  PIEZOMETRO DI MONITORAGGIO MULTIPOINT
-  DIREZIONE DI FLUSSO DELLA FALDA
-  LINEE DI TRASPORTO DEL PERMANGANATO



## 5.4 Radius of influence

A range of influence of 3.5 m was defined on the basis of the pilot test.

## 5.5 Process and performance monitoring

The monitoring consisted during the ISCO injection in the measurement of physical parameters with a multiparametric probe, namely: redox potential, dissolved oxygen, conductivity, pH and temperature twice a day. In particular, in the MW13 control piezometer, the continuous measurement of conductivity was provided to evaluate any permanganate leakage.

The first check in terms of chemical analysis of the compounds of interest was performed one week after the end of the injections.

Below is a summary of the monitoring carried out:

Deadline	MW13 (colour and redox)	pH, redox, conductivity, DO, T°, colour	Chemical analyses
Before the injection	NO	YES (a)	YES (a)
End of injection T0	YES	YES (b)	NO
1 week from T0	YES + analysis	YES (b)	NO
2 weeks from T0	YES	YES (b)	NO
3 weeks from T0	YES	YES (b)	NO
1 month from T0	YES + analysis	YES (b)	YES (b) + MW1
6 weeks from T0	YES	YES (b)	NO
2 months from T0	YES + analysis	YES (b)	YES (b) + MW1
3 months from T0	YES + analysis	YES (b)	YES (b) + MW1
4 months from T0- TESTING	YES	YES (a)	YES (a)

(a) Complete piezometric network: MW1, MW2, MW3, MW4, MW5, MW6, MW7, MW8, MW9, MW10, MW11, MP1-B, MP1-C, P1, EW1

(b) Reduced piezometric network: MW7, MW8, MW10, MW11, MW12, MP1-B, MP1-C and P1

The groundwater samples taken during the monitoring were subjected to the determination of organochlorine solvents, manganese and the following metals: Cd, Cr





VI, Fe, Cu, Pb, Zn. For the MW13 piezometer alone, the permanganate ion concentration was also determined.

The monitoring plan provided that, if the project objectives were achieved four months after the remediation intervention, post-operam monitoring would be activated; alternatively a second injection session would have been performed maintaining the same monitoring protocol as above, which was not necessary.

Due to an "anomalous" PCE value found on the expected date of testing on the MW4 piezometer upstream of the intervention area as well as the persistence of the purple colour inside the source area, testing was postponed to the next sampling, but also in this circumstance it was ascertained the persistence of the violet colour on the MW8 and MW11 piezometers inside the source area.

In the subsequent monitoring campaigns this criticality no longer emerged and the achievement of the remediation objectives for the organohalogen solvents for all the monitored points was verified.



## 6. Post treatment and/or Long Term Monitoring

### 6.1 Post treatment and/or Long Term Monitoring

From the end of the testing, post-construction monitoring was carried out for six years, starting from May 2013, according to the specifications shown in the table.

	Sampling	Frequency	Follow up actions
1st year	Complete piezometric network	quarterly	If compliant with the Italian threshold limits (CSC-CSR): shutdown of P1 (barrier well)
2nd year	Complete piezometric network	quarterly	
3rd year	Complete piezometric network	half-yearly	
4th year	Complete piezometric network	half-yearly	
5th year	Complete piezometric network	half-yearly	
6th year	Complete piezometric network	half-yearly	

The groundwater samples taken during post-construction monitoring involved the determination of organochlorine solvents and metals (Mg, Cd, Cr VI, Fe, Cu, Pb and Zn) only.

The last campaign carried out showed significant reductions in Mn, indicating that the permanganate had completely reacted in all the monitoring piezometers.

Barrier well P1 was shut down in July 2016.



## 7. Additional information

### 7.1 Lesson learnt

In general, ISCO offers the following advantages:

- ability to quickly treat a wide range of organic contaminants;
- allows you to set up temporary construction sites of limited size;
- It is particularly suitable for aliphatic compounds that chlorinate in not excessively fine horizons, to avoid the risk of rebound.

As a case-specific criticality, the presence of unreacted permanganate in the injection area was highlighted and therefore the barrier well was kept in operation until the injected permanganate was used up, as well as the maintenance of CSCs at the point of compliance. On the basis of the pilot test performed on site, however, the consumption of the injected product had occurred completely.

The lithological nature of the area subjected to injection, represented by very compact silt in the deeper horizons, has presumably influenced the distribution of permanganate, greatly slowing down its degradation. On the other hand, the failure to detect permanganate in the MW13 spy piezometer, located immediately downstream of the injection area, confirmed the poor mobility of the product due to the low permeability of the soil.

It is also noted that, from the analysis of the results of the post-operam monitoring, it is observed that with the exception of the MW8 piezometer, in which it is possible to appreciate the effectiveness of the intervention with total abatement of organohalogen solvents, for the other monitored points located in the area source (MW10, MP1B, MP1C) the concentrations of some halogenated solvents after total abatement in the first 4 months from injection gradually increased, settling on values around 15-20 ppm. This result is difficult to explain, especially if associated with the presence of unreacted product in the same points.

In relation to the monitoring of metals, the analysis of the analytical data showed a significant increase in the concentrations of Mn and lower increase of Fe in the piezometers located in the source area. No significant variations in the concentrations of metals before and after the intervention (therefore correlable to ISCO) for the other monitored piezometers were noted.

## 7.2 Additional information

The remediation objectives consisted of achieving concentration values below the Italian risk threshold (CSRs) for all the piezometers inside the site, defined by applying the site-specific risk analysis and coinciding with the contamination threshold concentrations (CSCs), i.e. the table limits conformity verification) for the MW7 piezometer placed at the site boundary, in the hydrogeological valley position, as specified in the table:

Parameter	CSR ( $\mu\text{g/L}$ ) for all piezometers inside the site, from Risk Assessment evaluation with reference to the "inhalation" path	CSR = CSC ( $\mu\text{g/L}$ )  For MW7 or site compliance point
PCE tetrachlorethylene	97	1.1
Trichloroethylene TCE	440	1.5
1,1 dichlorethylene	6.8	0.05
Cis-1,2 dichlorethylene	16000	60
1,2 dichloropropane	87	0.15
1,1,2 trichloroethane	220	0.2
Vinyl chloride	38	0.5

## 7.4 Additional remarks

With regard to the main limitations of this technology, it should be noted that:

- There is a need to ensure a physical or hydraulic barrier / margin protection system downstream of the treatment, in order to evaluate any leakage of the oxidizing agent outside the site or to avoid any migration phenomena of the reaction by-products towards sensitive targets (also in compliance with the 2005 APAT protocol mentioned above);
- Very strong oxidants can be corrosive and potentially explosive therefore particular attention must be paid to health & safety consideration ;
- The effectiveness of the process is influenced by the presence of heterogeneity of



the subsoil or by the poor mixing of the reagent in the groundwater;

- In certain cases, in areas difficult to access to the reagent, such as fine materials, the occurrence of rebound phenomena is noted. Consequently it is necessary to proceed with further injection cycles;
- Some reactants can be consumed by other oxidizable substrates present in the subsoil, thus limiting the effectiveness of the treatment;
- The use of permanganate could cause temporary increases in manganese concentrations and the precipitation of manganese oxides.

## Glossary of Terms

<b>Term (alphabetical order)</b>	<b>Definition</b>
CMA	Maximum Permissible Concentrations
CSC	contamination threshold concentrations
CSR	Risk Threshold Concentrations
D.Lgs.	Legislative decree
D.M.	Ministerial decree
MIP	Membrane Interface Probe
PdB	Remediation Plan
PNOD	Permanganate Natural Oxygen Demand
SVE	Soil vapour extraction

## 1. Contact details - CASE STUDY: ISCO n.14

<b>1.1 Name and Surname</b>	Uwe Dannwolf
<b>1.2 Country/Jurisdiction</b>	Germany
<b>1.3 Organisation</b>	RiskCom GmbH
<b>1.4 Position</b>	Managing Director
<b>1.5 Duties</b>	Project Manager
<b>1.6 Email address</b>	<a href="mailto:uwe.dannwolf@riskcom.de">uwe.dannwolf@riskcom.de</a>
<b>1.7 Phone number</b>	+49 8851 8969 480



## 2. Site background

### 2.1 History of the site: Challenges and Solution

From 1945 through 1983 “processing” of used chlorinated hydrocarbons took place on the subject area (former garage shop). Initial site investigations started in 1984. A six-year-long pump & treat remediation ceased in 2006.

Due to continuously high groundwater concentrations of PCE/TCE of up to 200,000 µg/L remediation was necessary.



Because parts of the subsurface contamination are located below a main road (see picture below) with services including a sewer, gas pipeline, telecommunications only in-situ remediation technologies were deemed feasible for remediation of this specific sub area. A variety of methods were evaluated including thermal but from a cost-benefit viewpoint was ISCO using hydraulic fracturing as the preferred method.

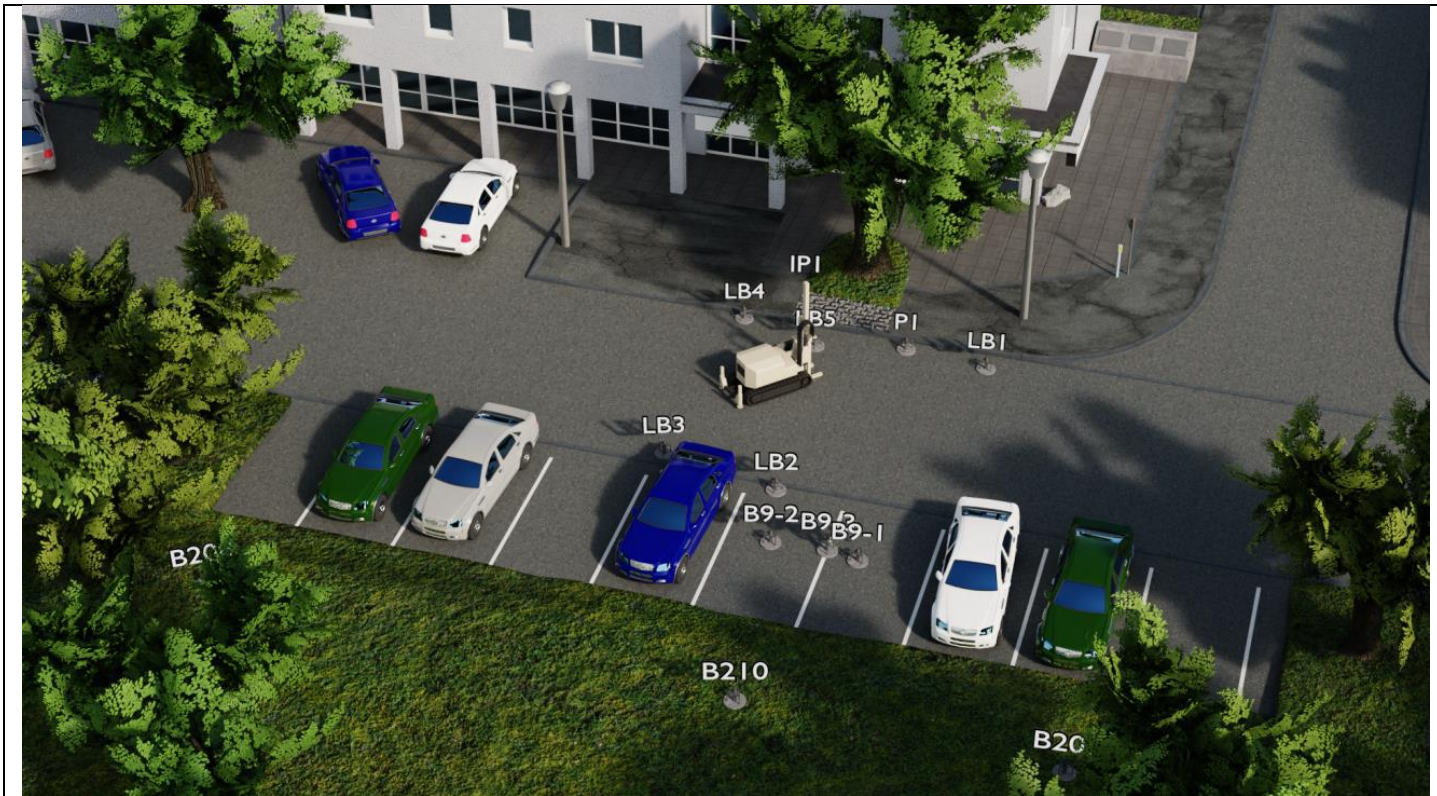

## 2.2 Geological and hydrogeological setting

The site is underlain by fill and Quaternary loess to a depth of 4 m below ground surface (bgs), which is overlaying a clayey silt layer followed by some silty clay layer of weathered marlstone to a depth of 7.5 m containing some perched water which is followed by the more competent, naturally fissured marlstone (Lias  $\beta$ ). The marlstone reaches down to at least 12 m bgs and serves as a confined low permeability dual porosity „aquifer“ with a groundwater flow of only 5 m / month mainly occurring in the fissures. The permeability of the weathered marlstone clay is  $7 \times 10^{-9}$  m/sec and marlstone exhibits a permeability of about  $5 \times 10^{-7}$  m/sec.

A redox boundary formed at a depth of around 6 m bgs (see picture below).



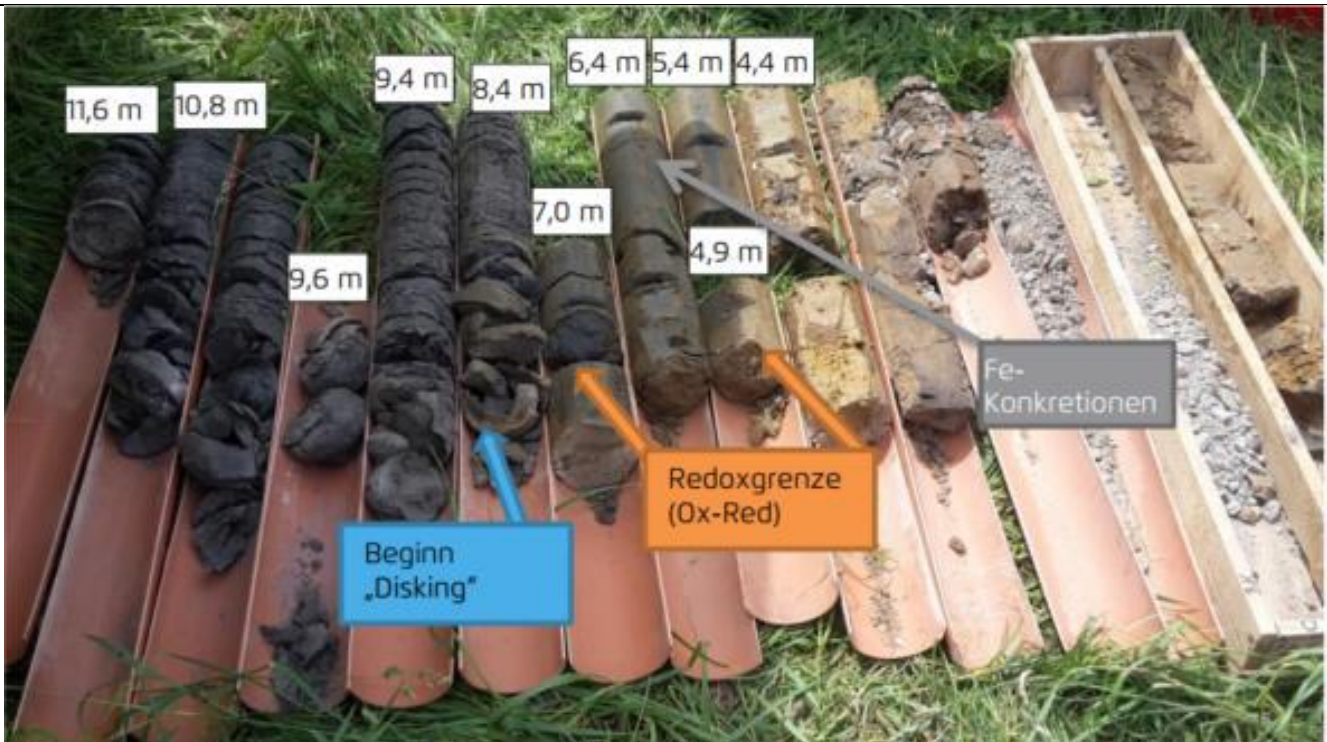

During the investigation phase, it was noted that the soil exhibited spots of high concentrations with neighbouring spots of low concentrations. The only interpretation at the time concluded that the subsurface is heterogeneous.

As a consequence, it was conducted research into the depositional environment followed by statistical analysis of the soil data including the type of clays. It could be shown that the natural heterogeneity based on TOC; Fe, Mn, Al, and NOD analyses had only a variation of  $\pm 20\%$ . This was much lower than the contaminant data variation which exceeded  $\pm 140\%$ . It was found that secondary diking structures were formed post-depositional and as a result of Tertiary and Quaternary overburden weathering. Post deposition and thereafter a vertical fracture network developed (as shown today in the marlstone) which subsequently partially healed as shown in the overlying tight weathered silty clays. This narrow spaced natural fracture network (fracture distance 0.2 m to about 1 m) was the pathway for contaminants to enter the subsurface to a depth of at least 10 m bgs. Vertical analytical transport modelling using a spreadsheet software proved this hypothesis.

From the CPTU data it was concluded that the soil contained some perched water to a depth of 4 m bgs. Below that depth the soil exhibited a pore water suction potential between -0.04 to -0.09 MPa to a depth of 12 m bgs. This fact had the potential of limiting the ISCO application significantly. Further research showed that for the reported suction potential enough water is present for sufficient diffusion of the oxidative front emanating from the permanganate and persulfate agents.



## 2.3 Contaminants of concern

Results of investigations in 2006 identified CVOC soil concentrations of the weathered clay of up to 75 mg/kg. Subsequent MIP-and CPTU investigations (pre RiskCom's involvement) including liner sampling provided a more detailed picture of the contamination and provided relevant geotechnical data in order to reliably plan the injection using hydraulic fracturing. Significantly higher CVOC soil concentrations of > 6,000 mg/kg were analysed during this campaign.

Groundwater samples indicated extreme concentrations of up to 447,000 µg/L total CVOC (on average about 150,000 µg/L) and up to 6,200 µg/L BTEX.

## 2.4 Regulatory framework

Due to continuously high groundwater concentrations of PCE/TCE of up to 200,000 µg/L, a remedial order was instigated.

The remediation plan focused on achieving a reasonable groundwater quality. Hence, a maximum CVOC discharge rate (i.e. mass flux) was prescribed. The prescribed goal is to reduce the contaminant mass with proportional means to such an extent that the long term total CVOC emission via the groundwater path is below 1 kg/a. An initial remediation target value for soil was 100 mg/kg total CVOC.

The competent Authorities were well satisfied with the method of hydraulic stimulation and the injection of 6 tons of permanganate and persulfate as solids was approved for the pilot test.



## 3. Laboratory-scale application in field

### 3.1 Laboratory scale application

Several lab tests for determination of a stoichiometric oxidant demand were conducted.

- SOD1 test on four samples with permanganate, and persulfate
- SOD2 batch tests on four soil samples before the injection with ground and intact soil samples from the clayey silt layer and the weathered marlstone for a period of 28 days
- SOD2 batch tests on ten soil samples from liner bores of the clayey silt layer and the weathered marlstone after the injection.

TIC and TOC as well as Fe and Mn were determined. With that data we were able to determine the oxidation state of the organic matter (OC) to +2.1 on average. With this evaluation the stoichiometric demand could be determined much better than using the standard methodology.

From the test results before the injection and after the injection the effectiveness of the oxidation was determined for the fraction of organic carbon and the CVOCs. It was determined that the clayey silt layer had a permanganate oxidant demand of 59 g/kg and the weathered marlstone had a permanganate oxidant demand of 78 g/kg. The SOD fast portion consisting of mainly Fe and OC required about 54% of the total SOD.

It could be shown from a detailed evaluation of the CPTU data that the suction potential is still in a range where saturated diffusion occurs. Henceforth, further kinetic parameters from the SOD2 tests were derived and initially an analytical kinetic diffusion model was developed and run. Later a numerical diffusion model ("quasi 2D") was run using CVOC input concentrations between 100 mg/kg to 2,000 mg/kg. It could be shown that PCE and TCE are faster oxidised than the SOD fast. SOD slow was much slower than the SOD fast which resulted in a 5 cm diffusion front for permanganate even for the 2,000 mg/kg CVOC concentration.

Consequently, the vertical distance between the hydraulically emplaced and permanganate laden fractures had to be in a 10 cm distance for a complete oxidation of the soil profile.

This distance of 10 cm was smaller than the distance originally chosen in the pilot test. Nevertheless, the result indicated that a complete remediation can be achieved if the full-scale application is conducted.

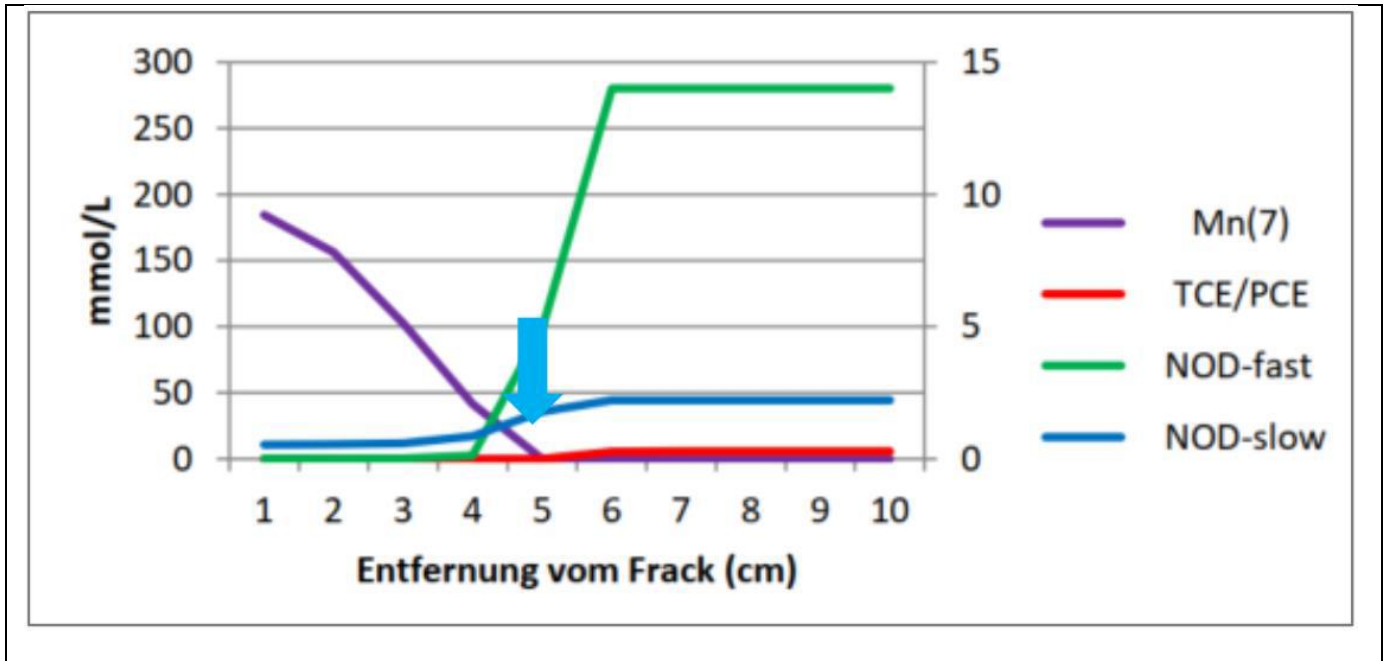

## 4. Pilot-scale application in field

### 4.1 Main treatment strategy

Due to the low permeability soil at the site hydraulic fracturing as injection technique was selected for the subsurface contamination below the main road, which was the pre-selected location for the pilot test. For the pilot test only one injection borehole was drilled. Remediation reagents were injected in the main contaminated area between 6.2 m and 10.5 m depth in a vertical distance of mainly 0.15 m.

Due to the low permeability clay and marlstone and the limited advective groundwater flow in the saturated zone as well as the dry conditions in the unsaturated zone, the injection of a combination of potassium permanganate ( $\text{KMnO}_4$ ) and sodium persulfate ( $\text{Na}_2\text{S}_2\text{O}_8$ ) was planned for the pilot test.

$\text{KMnO}_4$  was selected due to its fast reaction kinetics for the CHCs, its high diffusion coefficient, and its lack of interference with hydrogen carbonate ions.  $\text{Na}_2\text{S}_2\text{O}_8$  was selected due to its low solubility and the long persistence as well as its reported (e.g. Siegrist et al., 2011) lower tendency to oxidize the NOM (natural organic matter). It was intended to inject a 50%-mix of the reagents.

After the injection of each 1.6 t  $\text{KMnO}_4$  and  $\text{Na}_2\text{S}_2\text{O}_8$  between 6.2 m and 7.55 m a slight uplift of the road and a slight widening of an existing crack in the road were observed. It was concluded that the heave was attributable to a spontaneous gas formation. The gas



formation was generated through the addition of  $\text{Na}_2\text{S}_2\text{O}_8$  and the addition of 10% NaOH as activator. A post evaluation of the reaction kinetics showed that the amount of bivalent iron available in the soil would have been sufficient for the activation of  $\text{Na}_2\text{S}_2\text{O}_8$ . In this case the alkaline activation was excessive and unnecessary. As a consequence of the crack widening, the injection of  $\text{Na}_2\text{S}_2\text{O}_8$  was immediately ceased. The subsequent injection was carried out with  $\text{KMnO}_4$  only. At a depth of 8.8 m  $\text{Na}_2\text{S}_2\text{O}_8$  was again injected, however without the addition of NaOH. The uplift of the road and the widening of the crack stopped and declined immediately after the amended reagent formula was applied. Originally it was planned to inject 5.3 t of oxidising agents including the gelling agent and activators. Due to the amended reagent formula as a result of the gas formation only 3.4 t of reagents were injected. The schedule for the fieldwork was extremely tight since the injection borehole was located in the middle of a main road which was blocked for bus and public traffic for only two weeks.

## 4.2 Additives

Guar Gum was selected as a gelling agent and viscosifier.  
10% NaOH was added as activator.

## 4.3 Injection type

Remediation reagents were injected under pressure (hydraulic fracturing) in the main contaminated area between 6.2 m and 10.5 m depth via one injection borehole using the direct push system in one campaign. A total of 2.53 t of solid reagents ( $\text{Na}_2\text{S}_2\text{O}_8$ , "PS" and  $\text{KMnO}_4$ , "PM") without additives were injected.



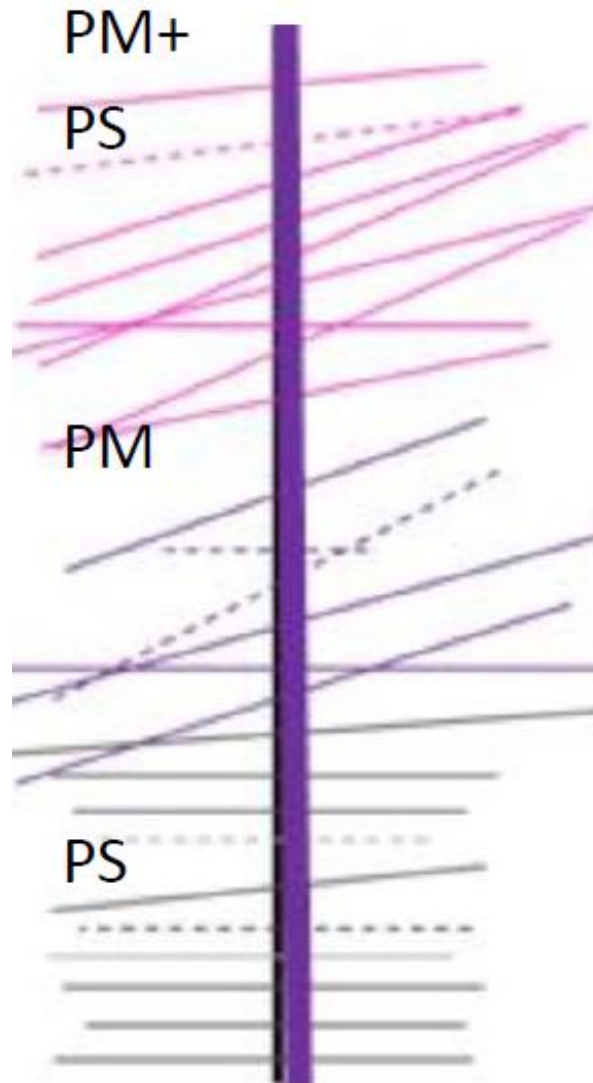

From 6 m bgs to 7.5 m bgs a mixture of solid permanganate and persulfate was injected. This was probably the first time when both agents were injected simultaneously. Thereafter, only solid permanganate was injected. The loading ranged from 150 to 250 kg per frac. From 9 m depth onwards only persulfate solution (50% concentration) was injected.

Our evaluation concluded that the reaction kinetics of persulfate and permanganate reached similar oxidation effects. However, the necessity of persulfate activation and its presumably lower diffusivity added additional complexity.

Mainly horizontal injection layers were generated in a vertical distance of mainly 0.15 m (see picture). Spatial monitoring of the artificially generated fractures was done using tiltmeters which were placed on the road's surface. A live evaluation of generated tiltmeter data allowed the on-site determination of each fracture with respect to its dip and strike. Later evaluation allowed the determination of the fracture thickness and lateral extent.

Measurements of the groundwater potential at three groundwater monitoring wells located around the injection borehole, indicated that existing fissures were (re)activated and thereby filled with reagents. This was also proven from real-time monitoring of the injection pressure data.

It could also be shown, that the generation of the 25 fractures increased the permeability at the area affected by the pilot test, which means that the groundwater flow locally (horizontally and vertically) became faster, which in turn positively influenced the distribution of the emplaced reagent afterwards.

It could be analytically proven that 25% of the injected  $\text{KMnO}_4$  was still available in the subsoil two months after the injection. After nearly two years of monitoring it could be shown that a one-time injection of the remedial agents was enough to reach the remediation goals in the pilot test area.

## 4.4 Radius of influence

The following calculations are based on the evaluation of the tiltmeter data (also see next section):

Over the entire depth of injection approximately 70% of the fractures show dip angles of less than  $20^\circ$  and only 30% of the fractures dip  $< 45^\circ$ .

The average thickness of the fractures was estimated to about 12 mm. The aspect ratio is  $\frac{3}{4}$  indicating that in line with the acting geotechnical stresses, ellipses instead of circles were formed. Compared to the radius of influence projected (5 m radius meaning 10 m in diameter) the calculated radii of influence for the  $\text{Na}_2\text{S}_2\text{O}_8$  at depth is below the radii of influence of the permanganate application due to its soluble state and larger leak-off into the surrounding soils during injection. The permanganate only injection and the mixture of permanganate and persulfate reached about a 4.5 m extent in one direction. The calculated radius of influence was proven by the results of the sampling of the liner bores (see picture below), which were spatially placed at the tip of the planned injection coverage.



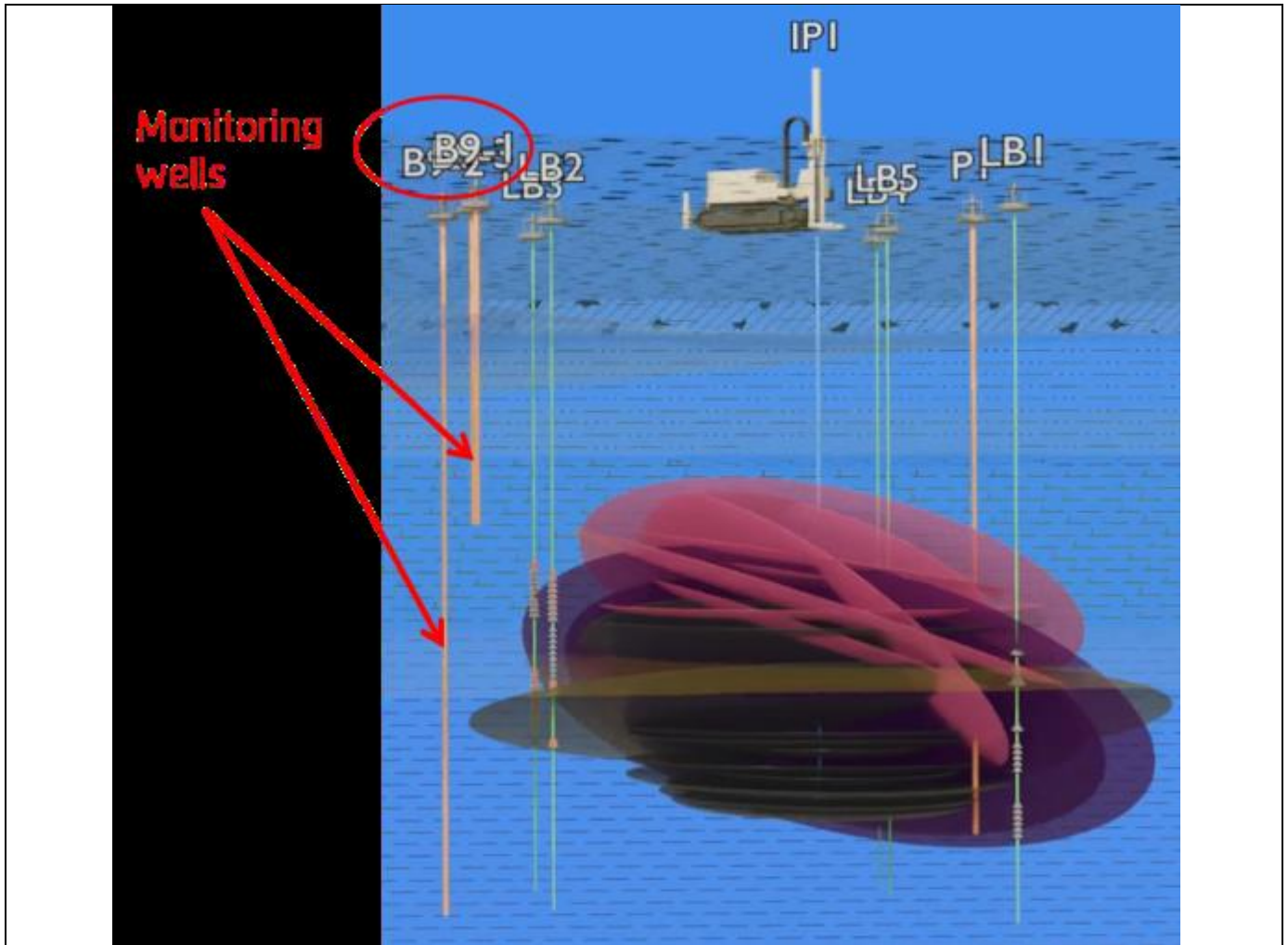

Furthermore, we were able to observe reagents in two groundwater monitoring wells screened in either the clayey silt layer and the weathered marlstone, which are located 7 m away from the injection bore aligned with the smaller axis of the ellipsoids (see picture left).



## 4.5 Control parameters

We recommend analysing for:

Soils (also from leachates as needed):

- CVOCs; here:
- Tetrachloroethane, Trichloroethane, cis-1,2-Dichloroethene, trans-1,2-Dichloroethene, Vinyl chloride, 1,1 Dichloroethane, 1,2 Dichloroethane, 1,1,1 Trichloroethane,
- dissolved iron, dissolved manganate, aluminium,
- Sodium, potassium, sulfate
- pH
- TC, TIC, TOC
- SOD.

Groundwater:

- CVOCs; here:
- Tetrachloroethene, Trichloroethene, cis-1,2-Dichloroethene, trans-1,2-Dichloroethene, Vinyl chloride, 1,1 Dichloroethane, 1,2 Dichloroethane, 1,1,1 Trichloroethane,
- CVOC Isotopes (C12/C13)
- anions, cations dissolved iron, dissolved manganate
- heavy metals
- chloride, and carbonate hardness.

## 5. Full-scale application

### 5.1 Main Reagent

Currently only a pilot scale application was performed. However, the results showed that there is no need for a full scale application for the achieved radius of influence in the pilot test area.

## 6. Post treatment and/or Long Term Monitoring

### 6.1 Post treatment and/or Long Term Monitoring

Two months after the injection of the reagents verification liner borings at five locations within the radius of influence were drilled. The liner borings (LB) showed the locations of most of the fractures via visual prove of pink (permanganate) and white (persulfate) discolouration.



Comparisons of CVOC concentrations in soil samples before the reagents were injected with CVOC concentrations in soil samples after the injection showed concentration reductions and concentration increases in various depths. We attribute these





discrepancies to the heterogeneity of the CVOC concentrations and the distance to the borehole where the baseline samples were taken from.

Interestingly, the analytical results of Na, SO<sub>4</sub>, and K show a clear correlation of the increased concentrations at the depth ranges where persulfate and permanganate were injected.

For monitoring and evaluation purposes of the remediation success groundwater samples were also taken from three groundwater monitoring wells around the injection bore immediately before the injection starts and within 18 months after injection on a bimonthly basis. The following parameters were analysed: Tetrachloroethene, Trichloroethene, cis-1,2-Dichloroethene, trans-1,2-Dichloroethene, Vinyl chloride, 1,1 Dichloroethane, 1,2 Dichloroethane, 1,1,1 Trichloroethane, Isotopes (C12/C13), dissolved iron, dissolved manganese, chloride, heavy metals, anions, cations and carbonate hardness.

Analytical results more than 18 months after injection showed an average 92% decrease of CVOC concentrations in the groundwater at all three monitoring wells with individual reductions between 80 % and 98% compared to the concentrations before the injection of the reagents.

The ratio between groundwater flux and mass reduction showed that the groundwater mass flux reduction is at least twice as high compared to the mass reduction in the soil after the injection of 3.4 t of oxidising reagents nearly two years ago.

## 7. Additional information

### 7.1 Lesson learnt

The presumed heterogeneity of the soils beneath the site is limited to about 20% variance. The presumed heterogeneity was caused by the presence of a natural fissure system, which could be proven by contaminant transport modelling. As a consequence, the previously existing conceptual site model was significantly enhanced, paving the way for a successful pilot test.

SOD analyses revealed that a high natural soil oxygen demand prevails at the site, which would in most cases have meant that ISCO would not be applicable as a remedy for the site. However, intensively evaluated data analyses also for kinetic parameters have led to a 2D numerical diffusion model (see Section 3.1) which showed that ISCO is a feasible remedy that can achieve remediation targets. A 10 cm fracture distance can achieve complete oxidation of the contaminants between the fractures. Consequently, verification bores should be placed not earlier than 4 months after the injection was completed.





Stringent injection data analyses were able to demonstrate not only the 3D-position of the fractures in the subsurface, but also the filling of the natural fissure system with the oxidative agents.

Mass-flux-reduction/mass-removal behaviour is a key indicator for sites with high groundwater concentrations and the existence of the natural fissure system as the mass-transfer process is rate limited. We were able to demonstrate that at the site there is no 1:1 ratio between mass-flux-reduction and mass-removal; instead we found a 2:1 ratio. This means that a significant mass flux reduction can be achieved by partial removal of contaminant mass from presumed DNAPL sources.

The ISCO pilot test using hydraulic fracturing as an emplacement method showed that a 50% reduction in contaminant mass achieved a 92% groundwater mass flux reduction.

A further outcome of the pilot test was that at the site persulfate activation is barely controllable for both the combination of permanganate and persulfate, and persulfate only. Uncontrolled persulfate activation in low permeability site coupled with the use of viscosifiers can lead to rapid gas development. The escape route of the produced gas can be limited by the low permeability of the soils.

Specific activation guides for persulfate are absent which would enable a safer handling of persulfate in high concentrations in low permeability environments coupled with a variety of metal oxides in the subsurface.

For a successful emplacement of oxidisers by means of hydraulic fracturing the diffusion coefficient plays a crucial role. The diffusion coefficient permanganate appears to be three orders of magnitude larger than the one for persulfate. Therefore, for the full scale application it was recommended to inject permanganate only.

## 7.2 Additional information

- The utmost importance for the successful completion of this pilot test was the fact that the client was convinced that a sound investigation phase and a proper and detailed evaluation period is a key factor. Without the applied scientific approach, both from the client and its consultant, this project would have been buried two months after injection, when the results of the liner bores first came to light and the CVOC reductions were well below the expectations.

Other factors were:

- There is a large difference between stoichiometry and kinetics especially for sites where very high concentrations (30-80%) of oxidisers are emplaced. This process should not be overlooked. Using kinetic information can lead to a remediation of site with very high SOD.



- Ambiguity exists for diffusion coefficients of persulfate especially when the activation energy is taken into account. Excess activation and oxidizable matter can lead to rapid gas development, which in low permeability environments must be controlled.

## 7.4 Additional remarks

Apply science and do not rely on gut-based comments from practitioners. Perform in-depth analyses for every process – even the ones you haven't specifically targeted for or were not on the radar screen.

Most tools are already available, for specific questions one might have to go the extra mile. It pays off in the end.

## 1. Contact details - CASE STUDY: ISCO n.15

<b>1.1 Name and Surname</b>	Edel, Hans-Georg
<b>1.2 Country/Jurisdiction</b>	Germany
<b>1.3 Organisation</b>	Züblin Umwelttechnik GmbH
<b>1.4 Position</b>	Manager R&D
<b>1.5 Duties</b>	In-situ remediation technologies, PFAS remediation, others
<b>1.6 Email address</b>	<a href="mailto:hans-georg.edel@zueblin.de">hans-georg.edel@zueblin.de</a>
<b>1.7 Phone number</b>	+49 7145 9324-249

## 2. Site background

### 2.1 History of the site: Challenges and Solution



Drilling work for the remediation wells in front of building 25/1

The project site, which has been in industrial use for some 90 years, exhibited massive contamination of the groundwater in the Keuper gypsum. The CVOC concentrations, whose origin could not be identified despite extensive investigation, peaked at 50 mg/l. Remediation was required in order to avoid further spreading of the contamination and minimize the hazard to the lower groundwater horizons. A number of different site-specific factors – e.g. the complex hydrogeological conditions and the continued use of the contaminated area as a customer centre – had to be taken into account.

Within the framework of a feasibility study on groundwater remediation various methods were examined in detail. They had to satisfy the following site-specific factors:

- Deep-lying fissured aquifer



- Extensive spread of the contamination plume through built-over area
- Consideration for the use of the affected works area as a customer centre with some
- 600 customers every working day
- Risk of so far undetected old explosive devices in the subsurface resulting from several bombardments of the works site and the former airfield during World War II.
- Multiple branched network of supply lines and sewer conduits

The feasibility study examined a number of innovative remediation. As a result of the study, in situ chemical oxidation was recommended as the method that can be most effectively implemented in compliance with the given site-specific factors. Apart from the site-specific reasons, it was decisive for the selection of this method that the high contaminant concentrations in the groundwater could potentially be effectively reduced within a relatively short period of time, thus decreasing the existing contaminant and hazard potential.

## 2.2 Geological and hydrogeological setting

### Geological subsurface conditions

The area of investigation lies in the northeast to southwest valley plain of two watercourses.

These two brooks were rerouted in the 1970s and partly buried in underground conduits. The natural subsurface is composed of Quaternary valley deposits, interlocking in some areas with mud. The Quaternary deposits consist of a very variably structured sequence of clay, silt, sand, and fine gravel, interspersed with 0.5-3.0 m thick layers of peat, as well as of mixed-grain mud fractions. The thickness of the Quaternary deposits ranges from approx. 3.5 m to 15.0 m.

The figure below is a schematic cross-section in west-east direction through the investigation area, also showing the depression. Further down lies the stratigraphic sequence of the Keuper gypsum, encompassing the units dark red marl, Bochsinger horizon, and gypsum bottom layers. The dark red marls are mostly reddish-brown, clayey silt soils with individual leached gypsum residues and friable, layered silty claystones.



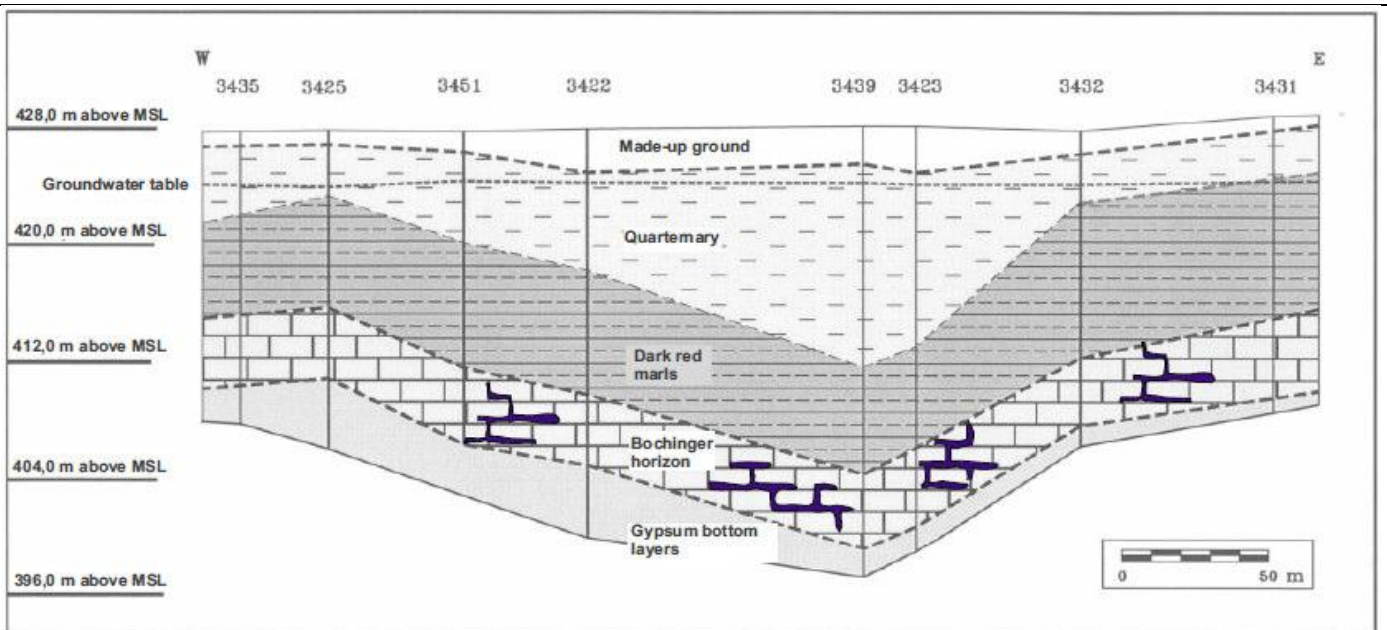

Geological cross-section in west-east direction, schematic

The layers of the underlying Bochliger horizon are composed primarily of claystones and silty claystones with leached gypsum residues and dolomitic beds. In the boreholes the thickness of the Bochliger horizon is between 4.6 m and 5.8 m. Further down the Bochliger horizon is succeeded by extensively leached gypsum bottom layers consisting of silty claystones incorporating numerous leached gypsum residues as well as residual silts and marly beds.

Towards the east and southeast there are also thicker gypsum layers. Gypsum leaching can produce cavities which are reproduced by the overlying layers. In the area of the contamination centre a doline-type structure with its lowest point near monitoring points GWM 3423 and GWM 3439 was encountered.

### Hydrogeological conditions

The investigation area shows two groundwater storey formations across the subsurface range explored by drilling. The upper groundwater horizon lies in the Quaternary valley deposits of the two brooks. Because of the interstratified subsurface structure with cohesive, peaty and sandy gravelly soils, the permeability conditions vary greatly, as ascertained by short pumping tests.

The Keuper gypsum layers generally show a layered and fissured aquifer system where the groundwater circulates in individual zones of increased permeability. In the investigation area, the groundwater within the Keuper gypsum sequence is carried mainly in the Bochliger horizon which has been accessed through the groundwater monitoring points installed.

The Bochliger horizon is characterized by a relatively high permeability ( $k_f$  value  $10^{-4}$  m/s)





and a high yield. The groundwater circulating there is hydraulically confined. The top edge of the Bochinger horizon was encountered at depths between 12.6 m and 23.6 m below ground level; the piezometric groundwater surface lies between approx. 3.5 m and 4.5 m below ground level.

In general, the direction of groundwater flow in the eastern section of the works site runs from east to west and then turns southwest to the south of the investigation area.

However, locally one must expect differing flow directions and a highly variable flow pattern.

## 2.3 Contaminants of concern

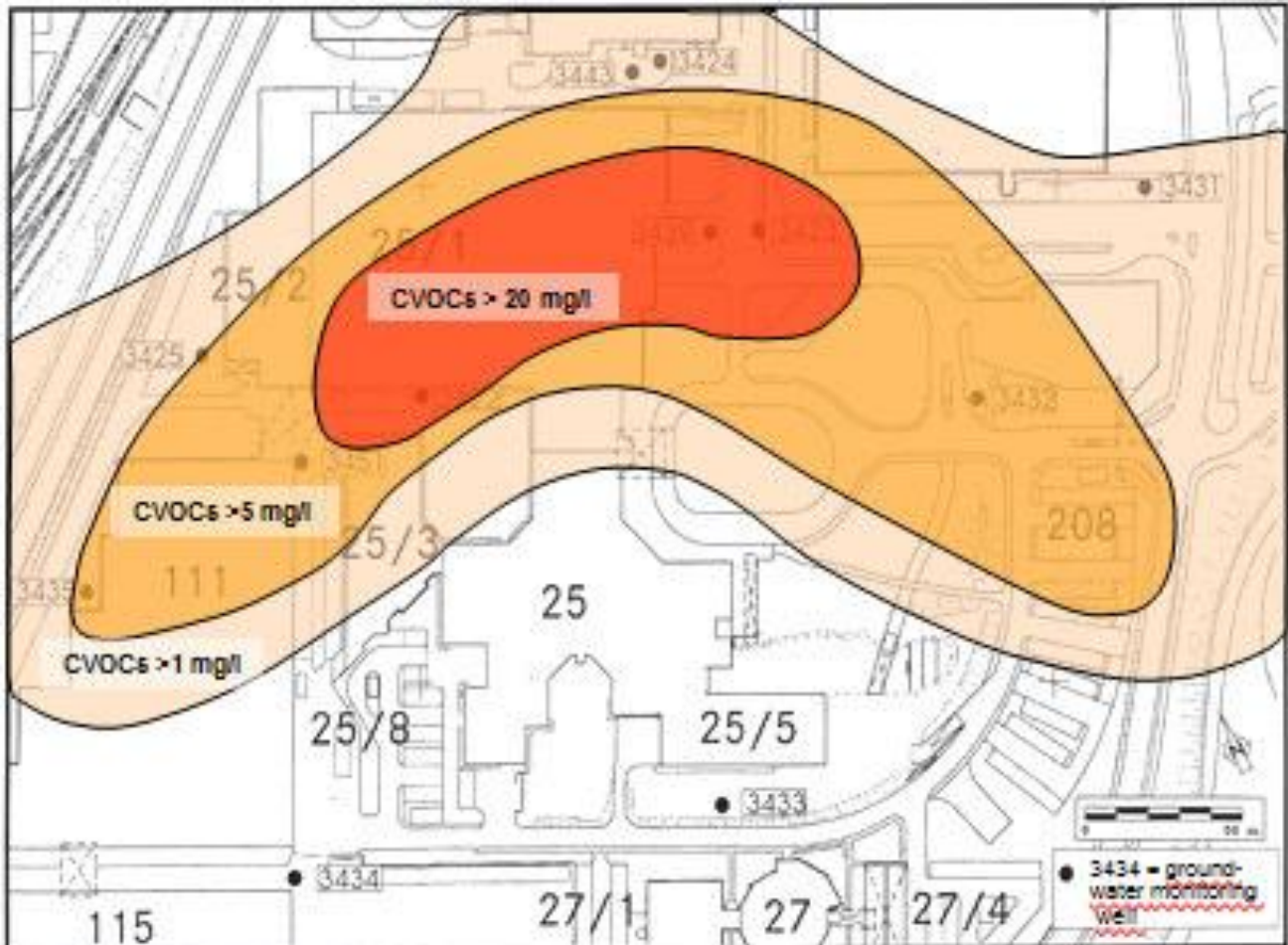

Contaminant distribution based on groundwater modelling before the start of remediation work in 2005

### Contaminant distribution in the groundwater

On the basis of the drillings and investigations performed, it was possible to largely delimit the lateral contaminant distribution, which extends in the contamination centre over an area of approx. 5,000 m<sup>2</sup>. The groundwater showed a clear CVOC maximum with concentrations from 30 to 50 mg/l in the region of monitoring points 3423 and 3439 on the eastern side of building 25. The contaminant spectrum was dominated by PCE which makes up approx. 80-90% of the CVOC total. Ranking secondary were TCE and cDCE as well as 1,1-dichloroethylene (1,1-DCE) and VC.

The drilling results from the actual investigation area, the works premises and the surroundings supplied the data for developing a groundwater model of the Keuper



gypsum aquifer at the Sindelfingen site. This model served to simulate the contaminant distribution in the investigation area using analytical findings from fixed-schedule sampling. The modelling result showed a contamination plume extending from east to west and turning southwest underneath building complex. In the downgradient flow further southwest, the contaminant concentrations were found to be reduced to 2-5 mg/l CVOCs.

With the isotope analyses it was established that the TCE and cDCE components found in the investigation area were direct by-products of the reductive dechlorination of tetrachlorethylene and not separately introduced contaminant components.



## 2.4 Regulatory framework

### Remediation permit and other legal aspects

With innovative remediation schemes in particular – here the full-scale application of the in situ chemical oxidation (ISCO) method for the first time in Germany – it is advisable to negotiate a public law contract, making it possible to regulate complex matters within the framework of a cooperation agreement. The preamble expressed the will of the contractual parties to undertake the required remediation, and thus defined a starting point for potential contract interpretations or changes at a later date. The contract also laid down the procedure, the cleanup implementation, the monitoring measures, and the contract adaptation or termination in specific cases. In addition, the contract covered steps for a possible change concerning the method, special control mechanisms, and the establishment of a project group. Because of the novelty associated with the chosen remediation method, it was contractually agreed to publish the procedure and provide a special documentation. The water resources permit was granted taking into account all aspects for the withdrawal of groundwater and the introduction of the oxidant. It was further contractually stipulated that the fundamental effectiveness of the method should be checked on site by corresponding laboratory and field tests, and that the applicable criteria for the dosing of the oxidant should be determined with a view to the soil properties in the aquifer. The mode of action of the ISCO method was to be checked by means of a remediation test, and the required peripheral conditions with respect to occupational health & safety, well location density and oxidant injection modalities were to be optimized. Due to the positive results obtained, a permit was granted for the remediation of the Keuper gypsum aquifer.

<i>Year</i>	<i>Measure</i>
<i>May 2003</i>	<i>Laboratory test</i>
<i>Sept. 2003</i>	<i>Injection test</i>
<i>Oct. 2003</i>	<i>Pilot-scale test</i>
<i>May 2004</i>	<i>Remediation test</i>
<i>Sept. 2005 – May 2008</i>	<i>Source remediation</i>
<i>Since June 2008</i>	<i>Monitoring programme</i>

Before being able to commence with the groundwater cleanup activities at the site, using the in-situ chemical oxidation method, it was necessary to carry out a step-by-step check of the suitability of the ISCO method under site-specific conditions. Ever since the conclusion of the source remediation in May 2008, a monitoring programme has been in place.

### 3. Laboratory-scale application in field

#### 3.1 Laboratory scale application

Chemical laboratory analyses of groundwater samples from the highly contaminated monitoring point GWM 3423 were performed in preparation for a field test.

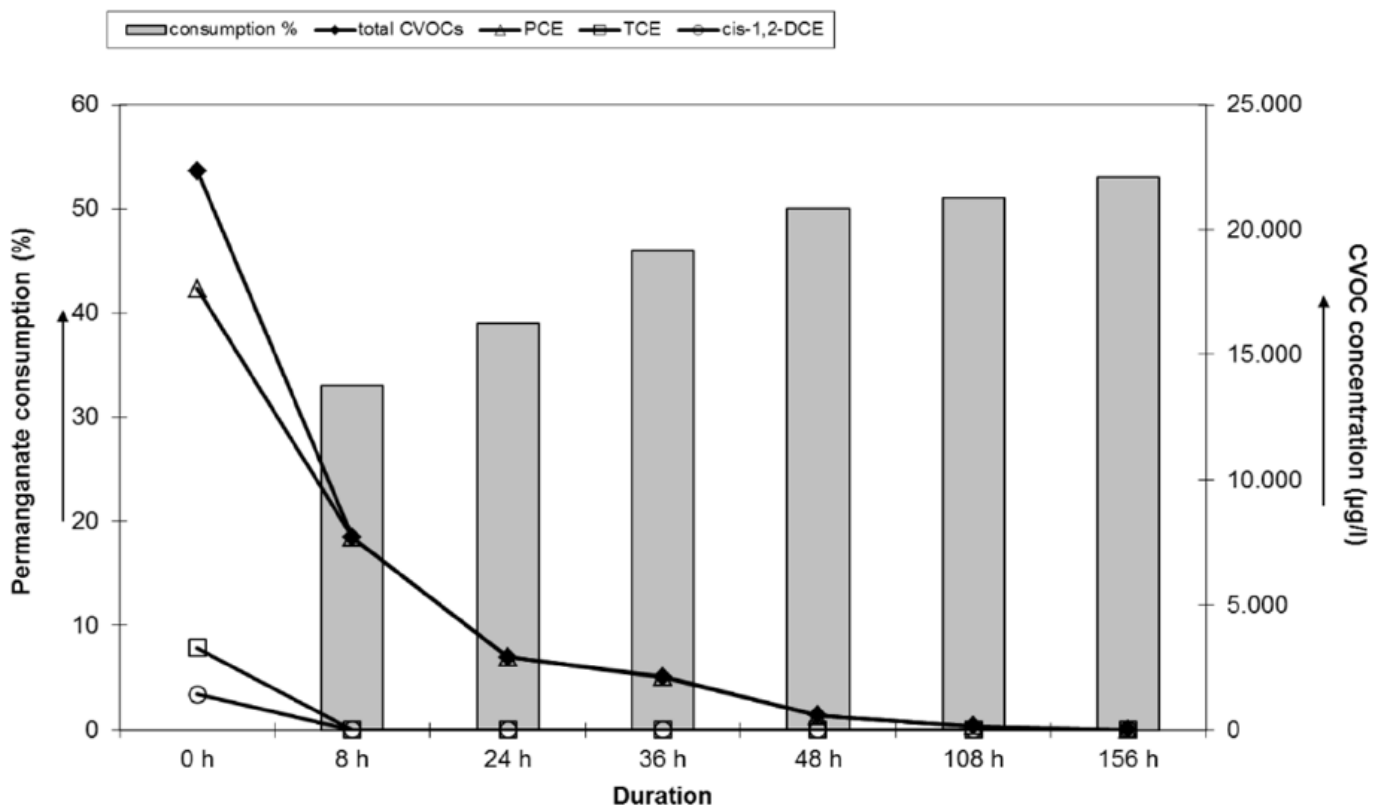

Laboratory test, oxidation of CVOC contaminated groundwater from monitoring point GWM 3423 using permanganate

The figure represents an example of a concentration curve of a measurement series with a permanganate concentration of 80 mg/l.

After only 8 hours the original CVOC content was degraded by almost 70%. The last measurement after 156 hours merely showed a concentration of 6.5 µg/l CVOC. Accordingly, the chlorinated ethylenes (PCE, TCE, cDCE, VC) were almost completely oxidized; this was however not the case with the chlorinated ethanes (1,1-dichloroethane and 1,1,1-trichloroethane) which were only present in low concentrations. In agreement with the literature (ITRC, 2006), the results show that low-chlorinated ethylenes are oxidized faster than higher chlorinated ones. The fast degradation was also promoted by a very low organic content of 2.0 to 3.5 mg/l TOC in the groundwater sample.



## 4. Pilot-scale application in field

### 4.1 Main treatment strategy

#### Pilot scale test

After the positive laboratory findings, the next step consisted of a pilot-scale test in the investigation area as a preparation for the ISCO cleanup of the groundwater using permanganate. It involved an injection test at monitoring point GWM 3424 and the actual pilot scale test with permanganate injections at monitoring points GWM 3423 and GWM 3424 as well as a four-week pumping measure at groundwater monitoring points 3422 and 3425 simultaneously.

The injection test showed that the groundwater level in the well rose in the case of permanganate injection compared to injection with ordinary water. The cause may possibly be that oxidation reactions in the filtration area already occurred during injection, so that reaction products hampered the outflow of the infiltrate. Moreover, the greater viscosity of the injection solution, compared with water, may also have been a reason for the rise in the water level.

The objective of the pilot-scale test was initially to test the method's basic mode of action at the site. Furthermore, it was to be checked to what extent the permanganate injected at monitoring points 3423 and 3424 could be distributed underneath building 25 by means of pumping measures in the downgradient monitoring points 3422 and 3425, in order to remediate the building area not directly accessible through drilling.

During the five-week pilot-scale test a total of approx. 1,390 kg  $\text{MnO}_4^-$  – in the form of sodium permanganate – was introduced into the contamination centre via the two monitoring points 3424 and 3423. To prevent uncontrolled drifting of the permanganate, approx. 7.5 m<sup>3</sup>/h of groundwater was abstracted in the downgradient flow at the two wells GWM 3425 and GWM 3422. The water was then cleaned in a mobile stripping plant down to CVOCs < 10 µg/l and discharged into the sewer system.

Accompanying the tests was an extensive monitoring programme carried out at a total of eight wells. The parameters CVOC,  $\text{Mn}^{2+}$ ,  $\text{Na}^+$ ,  $\text{Cl}^-$ , pH value, temperature, conductivity, and redox potential were measured at regular intervals at monitoring point 3439, which lies closest to the injection monitoring points, and at the two extraction wells. The other monitoring points were sampled before the start and after the end of the test phase, in order to assess the impact on the further surroundings.

It was found that the CVOC concentrations fluctuated. After injection of permanganate the contaminant levels were at first clearly reduced, only to increase later. The increase is most likely due to the subsequent inflow of contaminants into this area. In general, the results were inconclusive and could not be fully interpreted because of the rather large



test area.

### Remediation test

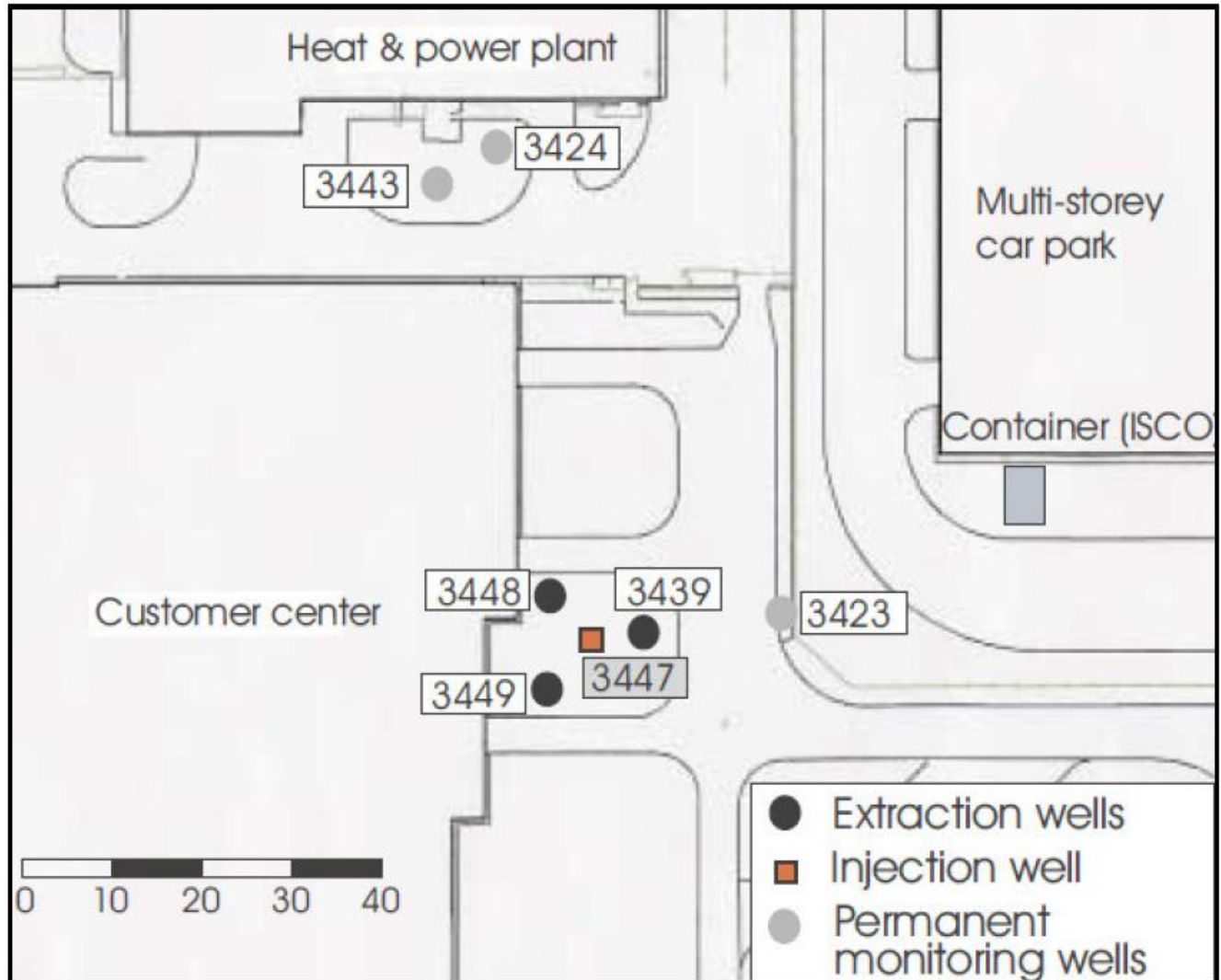

Layout plan of the test site with location of groundwater monitoring points

While the pilot-scale test in autumn 2003 covered a large area, the remediation test was carried out in a relatively small green area directly adjacent to building 25/1. The objective of the remediation test was to gain further insights with a view to the technical application of the ISCO method at this particular site. Firstly, significant oxidative destruction of CVOCs was to be proved; secondly, it was to be investigated how an optimum distribution and dosing of the oxidant in the subsurface could be implemented. Furthermore, it was to be tested to what extent the technical measures (drilling, pipe laying, etc.) would be acceptable in the area of the customer centre without undue disturbance.

The test concept envisaged the provision of a closed circulation system where the groundwater would be pumped off, enriched with permanganate and then reinfiltreated. The remediation test was also studied within the framework of a diploma thesis.

The test site comprised a small area of some 400 m<sup>2</sup> with the central groundwater monitoring point GWM 3447 used as an injection well and the three groundwater monitoring points GWM 3439, 3448 and 3449, which form a star pattern, serving as extraction wells. This arrangement and mode of operation were intended to ensure that the permanganate is distributed across the area without uncontrolled migration. The average circulation rate of the groundwater amounted to approx. 2.8 m<sup>3</sup>/h. In total, about 1.4 t of permanganate with a concentration of approx. 500-1,000 mg/l was injected and about 3,800 m<sup>3</sup> of groundwater was recirculated in the aquifer of the test site. The permanganate was injected over a period of six weeks. After termination of the permanganate injection the test facility was run for another three weeks. Before, during and after the test, groundwater samples were analysed for CVOCs, and on-site measurements were performed with regard to the pH value, temperature, conductivity, and redox potential. Manganese, sodium and chloride were analysed as additional parameters. Furthermore, samples were taken regularly and examined photometrically in the laboratory for their permanganate content. The table presents a comparison of the CVOC total concentrations at the start of the test compared to two and fourteen weeks after the end of the test.

Time period t[d]	CVOC total concentrations [mg/l] percentage (%)			
	GWM 3439 extraction	GWM 3448 extraction	GWM 3449 extraction	GWM 3447 injection
t = 0 d	37.3 (100%)	34.2 (100%)	34.3 (100%)	35.1 (100%)
t = 77 d	22.5 (60.3%)	22.8 (66.6%)	17.6 (51.3%)	15.5 (44.2%)
t = 162 d	20.7 (55.5%)	16.1 (47.0%)	19.9 (58.0%)	2.71 (7.7%)

Contaminant concentrations at the groundwater monitoring points of the remediation test during the period t = 0 d to t = 162 d

The contaminant reductions achieved within only five months are quite remarkable. However, without further remedial measures the contaminant concentrations would presumably have risen again due to the inflow of groundwater with higher pollution levels.

The parameters pH value and redox potential (Eh), which were measured on site, showed a clear reaction directly after the injection of permanganate and proved to be suitable indicators for the CVOC oxidation processes occurring in the subsurface. By contrast, the



measurements of conductivity and temperature did not find any significant changes. In tandem, a sample from GWM 3439 was examined for possible by-products by means of LC-MS screening (U.S. DOE., 2000). Initially, the findings showed glyoxylic acid with 0.12 mg/l, hydroxyacetic acid with 0.04 mg/l and oxalic acid with 0.46 mg/l. This screening was repeated 4 months later using another sample from the same monitoring point, in order to be able to assess the potential long-term accumulation of these acids. Here, the concentrations were below the respective determination limit of 0.05 mg/l for glyoxylic acid as well as 0.1 mg/l for hydroxyacetic acid and oxalic acid. With the exception of the existing CVOCs, chlorinated organic compounds, such as trichloroacetic acid, were not detected.

### 4.3 Injection type

- Existing groundwater monitoring wells (GWM) were used for injection of permanganate and for establishing a groundwater circulation (cf. chapter 4.1 Main treatment strategy, Remediation test).
- The distance between injection and extraction wells was about 10 m.
- Permanganate solution was injected into the Bochinger horizon in a depth of about 15-25 m bgl.
- The permanganate was injected continuously over a period of six weeks. After termination of the permanganate injection the test facility was run for another three weeks.
- Sodium permanganate was used as ISCO agent. In total 1.4 t  $\text{MnO}_4^-$  with a concentration of approx. 500-1,000 mg/l were injected.

### 4.4 Radius of influence

The distance between the injection and extraction wells was about 10 m. The establishing of a circulation system was verified by tracer tests using the rising conductivity caused by injection of sodium permanganate.

The radius of influence is regarded higher than 10 m since there are another 10 m radius of influence around the extraction wells.



## 4.5 Control parameters

Before, during and after the test, groundwater samples were analysed monthly for CVOCs, and on-site measurements were performed weekly with regard to the pH value, temperature, conductivity, and redox potential. Manganese, sodium and chloride were analysed as additional parameters twice. Furthermore, samples were taken regularly and examined photometrically in the laboratory for their permanganate content. In tandem, a sample from GWM 3439 was examined for possible by-products by means of LC-MS screening (U.S. DOE., 2000). Initially, the findings showed glyoxylic acid with 0.12 mg/l, hydroxyacetic acid with 0.04 mg/l and oxalic acid with 0.46 mg/l. This screening was repeated 4 months later using another sample from the same monitoring point, in order to be able to assess the potential long-term accumulation of these acids. Here, the concentrations were below the respective determination limit of 0.05 mg/l for glyoxylic acid as well as 0.1 mg/l for hydroxyacetic acid and oxalic acid. With the exception of the existing CVOCs, chlorinated organic compounds, such as trichloroacetic acid, were not detected.



## 5. Full-scale application

### 5.1 Main Reagent

#### Remediation

Due to the positive test results coupled with the cost and time advantages compared with a pump and treat scheme, the cleanup of the contamination centre was implemented using the ISCO method with permanganate. The relevant public authorities deliberately refrained from laying down a specific cleanup target. However, the objective was to employ the ISCO method in order to reduce the contaminant contents by about 80-90% within 2-3 years. The entire contamination zone extends over an area of approx. 20,000 m<sup>2</sup>, with some 5,000 m<sup>2</sup> thereof involving the contaminant source. Due to this large size and the limiting site conditions it was not possible to implement the method, as successfully tested, on a 1:1 basis across the entire contamination zone. The ISCO remediation was therefore restricted to the contamination centre located east of the customer centre, so as to achieve an effective contaminant reduction within a short time period and stop the further spreading of contaminants into the downgradient flow, as well as counter the hazard of migration into deeper groundwater horizons. In order to prevent uncontrolled movement of contaminants and permanganate, a pump-and-treat plant was installed as a hydraulic protection measure. This also served to distribute the oxidant over a large area underneath the building. The ISCO remediation in the Keuper gypsum aquifer proceeded in four successive phases. Initially, the cleanup took place in the area of the contamination source directly in front of the customer centre. Over a period of 15 months sodium permanganate was injected, as a dilution, into the upgradient groundwater wells; it was then transported westwards with the natural groundwater gradient. The transport and distribution of the oxidant were supported by groundwater extraction in the downgradient wells located in front of building 25/1. The extracted groundwater was cleaned and used as process water for diluting the 40% NaMnO<sub>4</sub> solution. Phase 2 The subsequent work, carried out over a period of 15 months, focussed on the contamination area underneath building 25/1. Here, a sodium permanganate dilution was injected through the groundwater monitoring points directly in front of building 25/1, and groundwater was extracted from the downgradient flow southwest behind the building. Phase 3 After termination of the phases 1 and 2, permanganate was once more injected through the wells directly in front of building 25/1, in order to create an oxidant pool for the destruction of the remaining CVOC content. Phase 4 In May 2008 the active measures of the ISCO cleanup project were concluded. Since that time a long-term monitoring programme has been running at the



site. If follow-up monitoring should indicate a rebound at individual wells, this will be dealt with by systematic permanganate injections. The groundwater in the downgradient area now contains only comparatively low CVOC concentrations of < 1 mg/l and is being cleaned via a conventional pump-and-treat system. The wells for downgradient protection are sampled at monthly intervals, all the other groundwater monitoring points at the site are sampled every six months and analysed for CVOCs, Mn<sup>2+</sup> and Cl<sup>-</sup>. It is also planned to repeat the LC-MS screening for by-products.

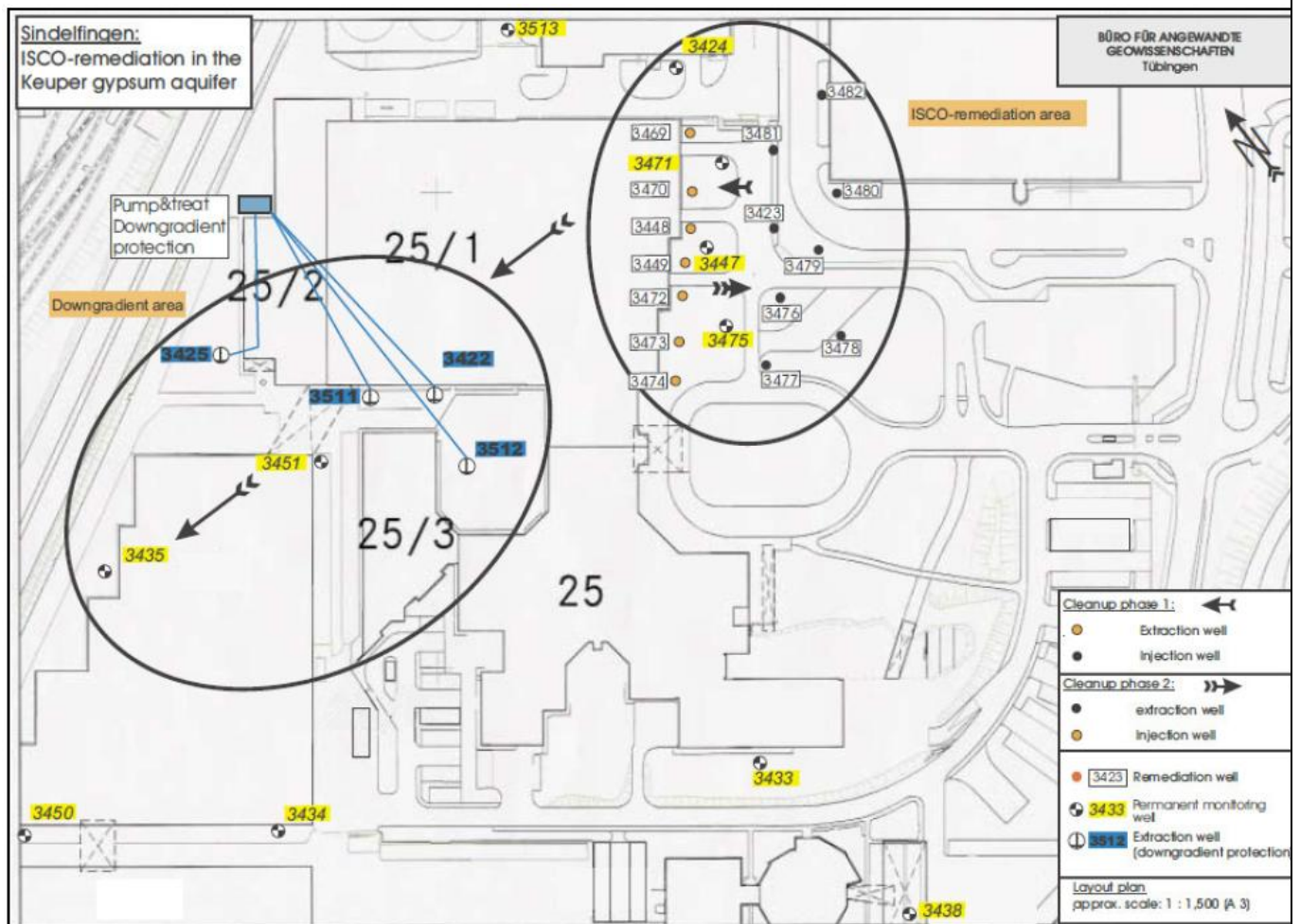

ISCO remediation of the Keuper gypsum aquifer. Layout plan with ISCO cleanup area and downgradient area

## Results

In the period from September 2005 to May 2008, a total of 30 tonnes of oxidant was injected, corresponding to the destruction of about 7,500-10,000 kg of CVOCs. This calculation is due to results of the field tests which indicated a specific oxidant demand of approx. 3-4 kg permanganate per kg CVOCs. The figure below depicts the ISCO plant



technology including a dosing station for sodium permanganate.



ISCO plant technology



ISCO dosing station

The project achieved a reduction in the CVOC concentrations at the contamination centre down to approx. 0.1-1.9 mg/l, which equals a mean decrease of around 90-95%. As another positive result it should be noted that, with the exception of one well, there has been no significant rebound of the contaminant concentrations. Reduced permeability in the Keuper gypsum aquifer due to  $MnO_2$  precipitation could not be detected.

The ISCO measure at the contamination centre has also had a positive effect on the downgradient flow. Currently (status 12/2020) the CVOC concentrations in the downgradient wells lie below 0.5 mg/l and have thus been reduced by approx. 85-90%. Consequently, in-situ chemical oxidation also offered economic advantages compared with the conventional pump-and-treat method.

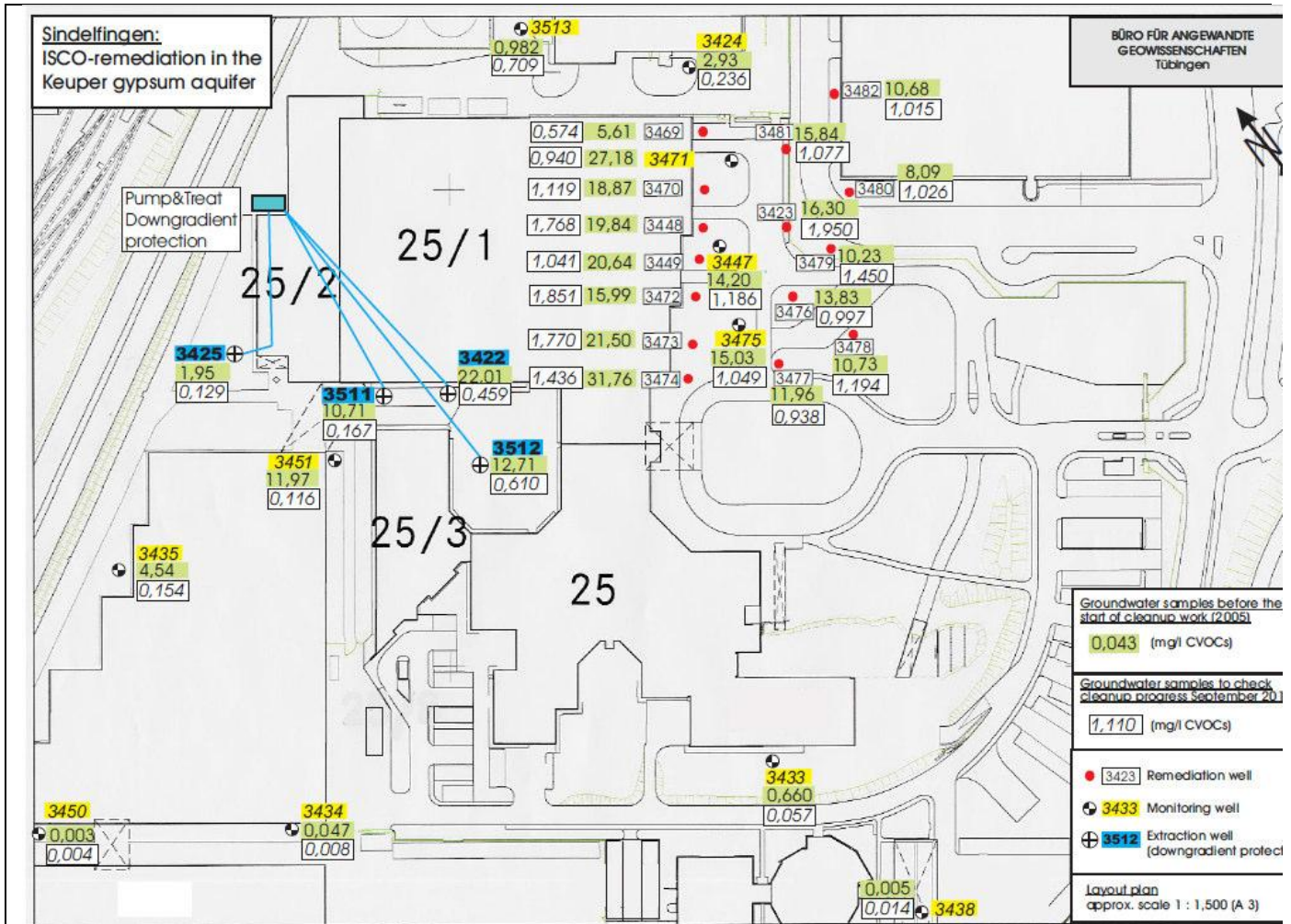

Contaminant concentrations before the start and after conclusion of active ISCO remediation in the Keuper gypsum aquifer (status December 2019)



### 5.3 Injection type

- Existing wells were used and new injection wells in front of building 25/1 were drilled.
- In phase 2 of the remediation works the new wells were used for ISCO treatment of the contamination area underneath building 25/1.
- Permanganate was injected continuously over a period of 15 months in phase 1 and in phase 2. After termination of the phases 1 and 2, permanganate was once more injected through the wells directly in front of building 25/1, in order to create an oxidant pool for the destruction of the remaining CVOC content. A total of 30 tonnes of oxidant with a concentration of 500 –mg/L  $MnO_4$  was injected in the period from September 2005 to May 2008.

### 5.4 Radius of influence

The transport and distribution of the oxidant were supported by groundwater extraction downstream. The distance of influence was 50 – 100 m verified by monitoring.

### 5.5 Process and performance monitoring

The wells for downgradient protection are sampled at monthly intervals, all the other groundwater monitoring points at the site are sampled every six months and analysed for CVOCs,  $Mn^{2+}$  and  $Cl^-$ . On-site measurements were performed weekly to monthly with regard to the pH value, temperature, conductivity, and redox potential.





## 6. Post treatment and/or Long Term Monitoring

### 6.1 Post treatment and/or Long Term Monitoring

Since termination of the active remediation all wells and are sampled twice per year and analysed for CVOCs.

## 7. Additional information

### 7.1 Lesson learnt

#### **Difficulties and weaknesses, successes and strengths, keystones, shortcomings and rooms for improvement**

The project achieved a reduction in the CVOC concentrations at the contamination centre down to approx. 0.1-1.9 mg/l (status 12/2020), which equals a mean decrease of around 90-95%. As another positive result it should be noted that, with the exception of one well, there has been no significant rebound of the contaminant concentrations. Reduced permeability in the Keuper gypsum aquifer due to  $MnO_2$  precipitation could not be detected. The ISCO measure at the contamination centre has also had a positive effect on the downgradient flow. Currently (status 12/2020) the CVOC concentrations in the downgradient wells lie below 0.5 mg/l and have thus been reduced by approx. 85-90%. Consequently, in-situ chemical oxidation also offered economic advantages compared with the conventional pump-and-treat method.

#### **Outlook**

In-situ chemical oxidation is an established and very promising groundwater remediation technology suitable for a wide range of organic contaminants. Among the various in-situ methods, ISCO occupies a prominent market position in Germany and is also increasingly being applied in other European countries. The projects of Züblin Umwelttechnik GmbH implemented so far at more than 40 different contaminated sites have shown that the ISCO method enables a fast reduction of high contamination levels in groundwater. Additionally, the method is also very well suited for minimizing the existing contamination potentials underneath buildings. The direct contact of pollutants and oxidants is the essential prerequisite for a successful application of the ISCO technique. ISCO in a low permeable underground is a challenge but can be realized successfully using specific injection technology (e.g. fixed manchette tubes). However, the ISCO method cannot be applied for all types of contamination involving CVOCs or organic pollutants. Large pools of DNAPL and LNAPL phase cannot be remediated using ISCO. For economic reasons, the method is less suitable for the remediation of extensive



contamination plumes or soils with a very high content of organic substances. The successful application of the ISCO method requires detailed knowledge of the subsurface conditions and the spatial distribution of the contaminants, as well as broad practical experience. Field tests for checking the cleaning efficiency in the aquifer are strongly recommended in case of complex hydrogeological situation.

### **7.3 Training need**

Workshops, training on-the job, webinars, e-learning could be an effective training tool



## 1. Contact details - CASE STUDY: ISCO n.16

<b>1.1 Name and Surname</b>	Federica Danesin
<b>1.2 Country/Jurisdiction</b>	Italy
<b>1.3 Organisation</b>	ARPAV – Agenzia Regionale per la Prevenzione e la Protezione Ambientale del Veneto
<b>1.4 Position</b>	Professional Technical Collaborator
<b>1.5 Duties</b>	
<b>1.6 Email address</b>	federica.danesin@arpa.veneto.it
<b>1.7 Phone number</b>	+39 041 544 5642

## 2. Site background

### 2.1 History of the site: Challenges and Solution

The area subjected to the remediation is into the Porto Marghera Site of National Interest - Venice – Italy

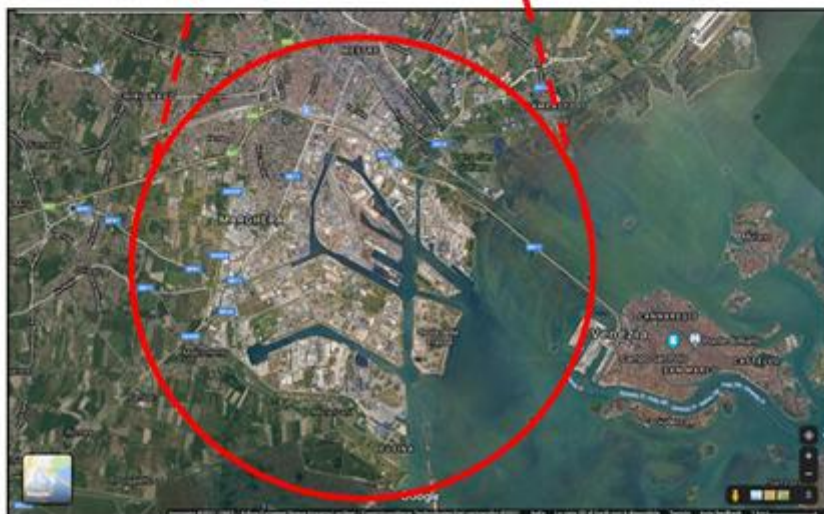



## 2.2 Geological and hydrogeological setting

- The area subjected by the remediation has a flat surface, at an approximate altitude of 3 meters above the average sea level.
- The surface morphology of the area is the result of the lagoon landscaping carried out in the past to enlarge the industrial area, with the creation of the peninsula now called “Nuovo Petrolchimico”. The sales pitch was aimed at raising and levelling the area to enlarge the industrial area, and is made up of material of a heterogeneous nature, often residues of industrial processing. Within this backfilled material, saturated areas impregnated with water are observed, commonly defined as “groundwater in the backfill” or “backfill impregnation waters”. The absolute altitude of the groundwater level is quite variable and cannot be correlated with each other, making it impossible to identify a real direction of groundwater flow.
- From the ground level to a depth of about 3 meters: heterogeneous fill layer, consisting of coarse material (gravel, tout-venant) in fine matrix (sands, silty sands, silts), used in the past for the raising of the ground level and for the localized filling of the most depressed areas, in order to create the new industrial zone.
- Up to a depth of about 5 meters from the ground level: fill made up of red bauxitic mud or blackish mud. Materials of pasty consistency, compact, of variable thickness within the site, used in the past for the artificial filling of the lagoon sandstone area and the raising of the countryside floor, in order to create the new industrial area.
- Depth of the aquifer of the backfill from the ground level 1.2 m



## 2.3 Contaminants of concern

Given the nature of the fill and the relative “suspended” aquifer characteristic of the Porto Marghera area, the qualitative state of the environmental matrices is not homogeneous within the site. The characteristics of the very limited area, identified by the LEV06 survey, on which the In Situ Chemical Oxidation (ISCO) technology has been applied, are reported.

The area actually affected by the reclamation intervention is equal to 450 m<sup>2</sup>.

The integrative characterization, carried out in January 2016, also showed exceedances in the S2 and S5 surveys which confirmed the presence of heavy hydrocarbons C> 12 and some polycyclic aromatic hydrocarbons (PAHs). The overall portion of contaminated land is between 3 m and 5 m from the ground level

The contamination was detected between 4 m and 4.6 m deep and it is due to the presence of heavy hydrocarbons C>12, detected in a concentration equal to 837 mg/kg and some PAHs (benzo(a)anthracene 16, 1 mg/kg, benzo(b)fluoranthene 22.5 mg/kg, benzo(a)pyrene 15.3 mg/kg and indeno(1,2,3-cd)pyrene 10.3 mg/kg).

There is no NAPL (Non-Aqueous Phase Liquids)

Qualitative status of the groundwater in the LEV06 piezometer, located near the intervention lot with ISCO:

- Al: 146 µg/l
- As: 44.6 µg/l
- Mn: 42.4 µg/l
- Benzene: 1.38 µg/l
- Vinyl chloride monomer (VCM): 2.47 µg/l
- 1,1-dichloroethylene: 0.00914 µg/l
- Sulphates: 6.63 µg/l

## 2.4 Regulatory framework

- Italian Legislative Decree 152/2006
- Italian Ministerial Decree 31/2015
- “Accordo di Programma per la Bonifica e la Riquilificazione Ambientale del Sito di Interesse Nazionale di Venezia – Porto Marghera e Aree Limitrofe”



### 3. Laboratory-scale application in field

#### 3.1 Laboratory scale application

Due to the deep location of the contamination and the heterogeneity of the backfill, no laboratory tests were performed as they were considered not significant.

### 4. Full-scale application

#### 4.1 Main Reagent

ISCO technology was chosen for the depth to which the contaminated layer was located and for the ability of oxidizing substances to degrade hydrocarbons into simpler compounds that are generally not critical for the environment.

For the case under examination, two oxidizing compounds produced by Regenesis were chosen.

For the first cycle, it has been chosen the compound Regenox™, which is a compound designed to treat areas characterized by elevated concentrations of organic contaminants. The main characteristics of the product can be summarized as follows:

- It allows rapid and effective oxidation of a wide range of compounds, such as hydrocarbons (aromatic, aliphatic, polyaromatic, chlorinated);
- It consists of two parts:
  - Part A: it is the oxidizing complex consisting of a mixture of sodium percarbonate ( $2\text{Na}_2\text{CO}_3 \cdot 3\text{H}_2\text{O}_2$ ), sodium carbonate ( $\text{Na}_2\text{CO}_3$ ), sodium silicate and silica gel. The oxidizing complex appears as a fine white powder.
  - Part B: it is the activator complex consisting of a mixture of sodium silicate, silica gel and ferrous sulphate. It looks like a liquid gel. It has a rather limited longevity and acts only on the desorbed phase.

For the second cycle, it was planned to use an oxidizing product with a greater capacity to permeate the subsoil such as Sodium Persulfate ( $\text{Na}_2\text{S}_2\text{O}_8$ ). In fact, together with a high oxidation potential, Sodium Persulfate has characteristics of high solubility and medium persistence in the subsoil. With a solubility limit equal to 40% w/w it is therefore possible to apply, for the same volume of injected solution, a greater quantity of oxidant. The reagent, suitably activated (thermally or chemically) produces the release of free radicals with high oxidation potential ( $\text{SO}_4^{\cdot-}$ ,  $\text{OH}^{\cdot}$ ,  $\text{O}_2^{\cdot-}$ ) allowing the degradation of a broad spectrum of contaminants including organic compounds such as PAHs.



In consideration of the characteristics of the subsoil and the contaminants to be treated it is provided the use of a solution of 15% Sodium Persulfate, together with an activator based on caustic soda in 25% solution.

The criticalities found in the case in question are due to the low permeability of the soil and the recalcitrant nature of the PAHs

### **Reactive dosage**

The theoretical dosage of RegenOx provides for an oxidant / hydrocarbon weight ratio equal to

10: 1. In this case, the theoretical dosage requires the use of 140 kg of oxidant.

In the case of injections in saturated soils, the yields for this type of intervention vary from 40% to 95% depending on the site specifics and contaminant characteristics. To ensure an adequate safety margin, it was chosen for a double dosage of oxidant, equal to a total of 300 kg. A similar quantity will be provided for the activator Part B.

According to the supplier's instructions, in order to obtain an 8% aqueous solution of oxidant, it was necessary add a quantity of water equal to about 10 liters per kilogram of oxidizer and activating agent. Therefore, for the procedure it was necessary to use a volume of water equal to approximately 3 m<sup>3</sup>.

Since it was planned to apply the oxidizer through multiple injection points, the preparation of the solution was carried out by dividing the quantities on the basis of the number of injection points.

As for the Sodium Persulfate, 400 liters of reagent were injected into the soil at each input point., resulting from the mixing of sodium persulfate at 15% and caustic soda at 25% according to the following proportions:

- 50 kg of Sodium Persulfate (Na<sub>2</sub>S<sub>2</sub>O<sub>8</sub>) at 15% in 350 l of water;
- 15 kg of Caustic Soda (NaOH) at 25% in 50 l of water.

### **Application system**

#### **First course of treatment**

The injection of the solution containing the RegenOx™ in deep soil was carried out by direct injection, with direct push machines like Geoprobe® in order to improve the oxidant distribution and homogenization in the aquifer. Due to the limited soil thickness to be treated, direct injection has been done in bottom-up mode. The injection probe, the final element of the drill rod system, is brought to the maximum depth to be treated. This probe was equipped with a nozzle opening-closing system controlled by surface, integral with the probe or disposable. This probe was equipped with a nozzle opening-closing system controlled by surface, integral with the probe or disposable. Once the desired depth is reached, the rod system was connected to the injection pump, which in turn was connected to the tank containing the oxidizing solution. At this



point the injection nozzle was opened, and then the pumping of the solution started. The pumping was continued during the rods system rise, until this reached the minimum depth of treatment. The injection system must have a volumetric counter, to allow dosing of the correct volume of solution per unit of vertical length. To guarantee a safety margin, the injection will be carried out between the depths of 3.8 m and 4.8 m from the ground level. Once the upper end of the injection interval has been reached, the same injection system will be used for the injection of a bentonite mixture during the ascent of the rod system to the surface.

The first injections cycle were performed on 30, 31 May and 1 June 2016, the second one on 11, 12 and 13 July 2016. Overall, during the two campaigns, 27 injections positioned around the polluted points of investigation LEV06, S2 and S5 were performed, where the contamination by heavy hydrocarbons C<sub>>12</sub> and PAH was found. Specifically, around each point 9 injections were done according to the configuration below:

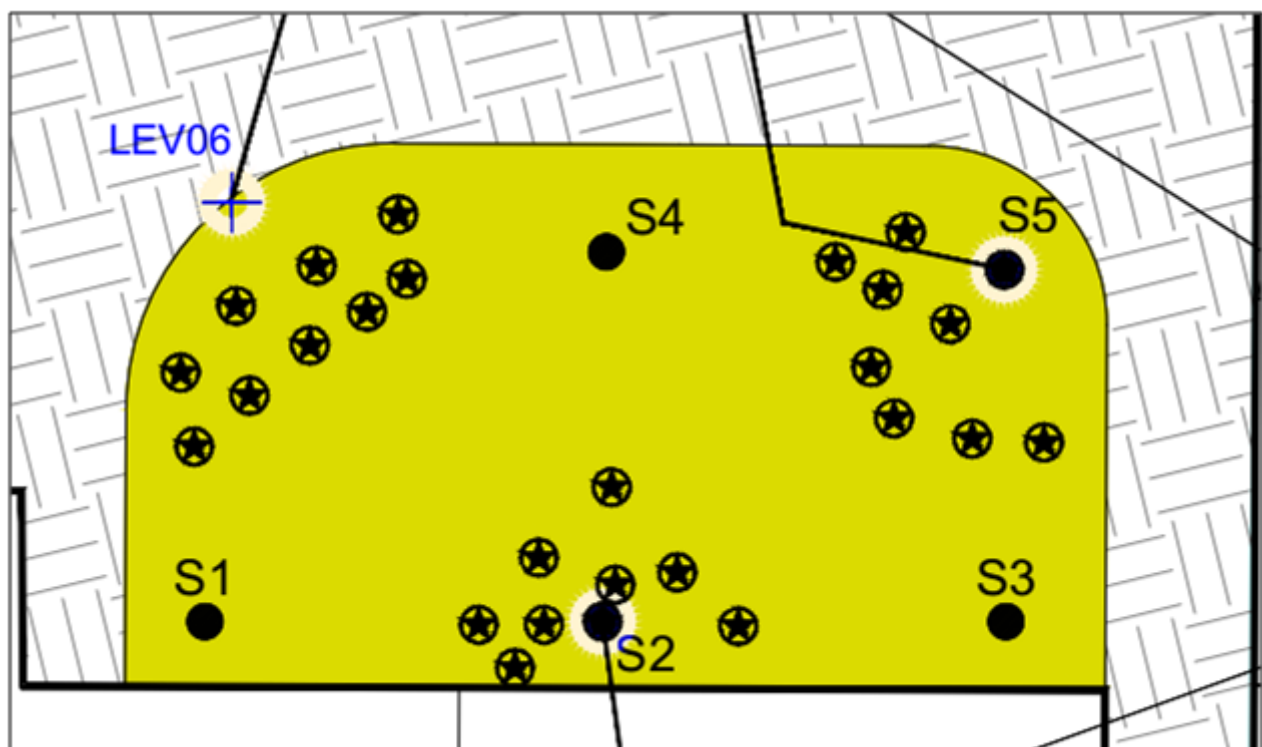

Following the injection of the oxidizing mixture, the remediation monitoring activity was carried out, which included the execution of n. 4 boreholes, with a fortnightly frequency, up to 5 m deep, for a total of 3 survey campaigns from 01/08/2016 to 29/08/2016 (T1, T2 and T3). In this way, the effect of the oxidizing mixture was monitored respect to the portion of soil subject to remediation (between 3.0 m and 5.0 m of depth from the

ground level) As shown in the following figure, the results of the performed monitoring showed a residual contamination by PAHs and heavy hydrocarbons ( $C > 12$ ) compared to the contamination threshold concentrations (CSC) and the risk threshold concentrations (CSR) of reference provided by the Italian legislation, exclusively between 4.0 m and 5.0 m of depth, therefore in saturated soil, in the ST2 and ST4 boreholes, carried out at verification time T1 and in the ST4btris borehole carried out at verification time T3.

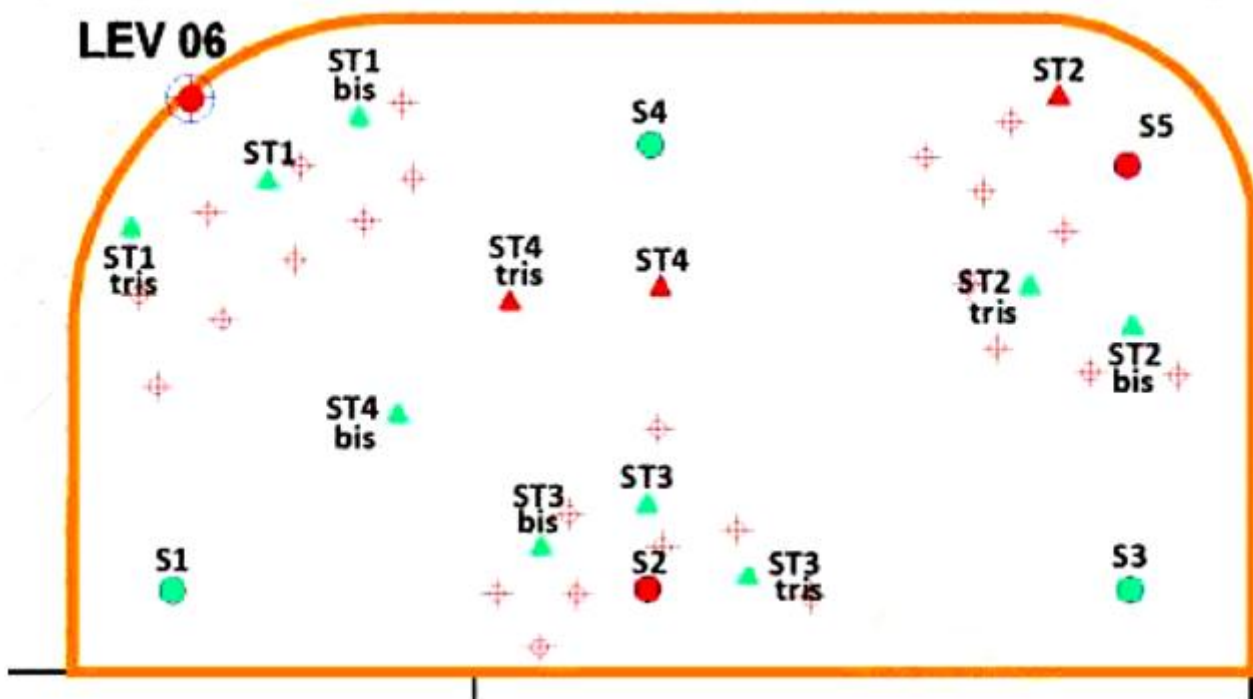

Samples to monitor remediation (ST, STbis, STtris), green means that the target concentration was reached, red means that the target concentration was not reached

In order to better define the extent of the contamination identified in the survey were ST4tris additional investigations, on 15 November 2016, were carried out:

- the perforation of 3 geognostic boreholes, up to a depth of about 5 m by the ground level (SC1, SC2 and SC3), located around the ST4tris borehole, as shown in the following figure;
- the taking of 5 soil samples corresponding to each survey (one sample representative for each meter of depth in accordance with the provisions of the current Italian law - "Protocollo operativo per la caratterizzazione dei siti ai sensi del D. Lgs.152/06 e dell'accordo di programma per la chimica di Porto Marghera – Revisione Gennaio 2008"). Altogether they were sampled and sent to the laboratory 15 samples;

- laboratory analyzes to research polycyclic aromatic hydrocarbons (PAHs) and heavy hydrocarbons C > 12.

The analytical results relating to the supplementary investigation campaign showed that the CSCs were exceeded for heavy hydrocarbons C > 12, for the SC3 and SC1 boreholes, but with concentrations lower than the target values, equal to 2200 mg/kg. For the PAHs, modest exceedances of the CSCs (corresponding to the target values) are identified in SC3 borehole only.

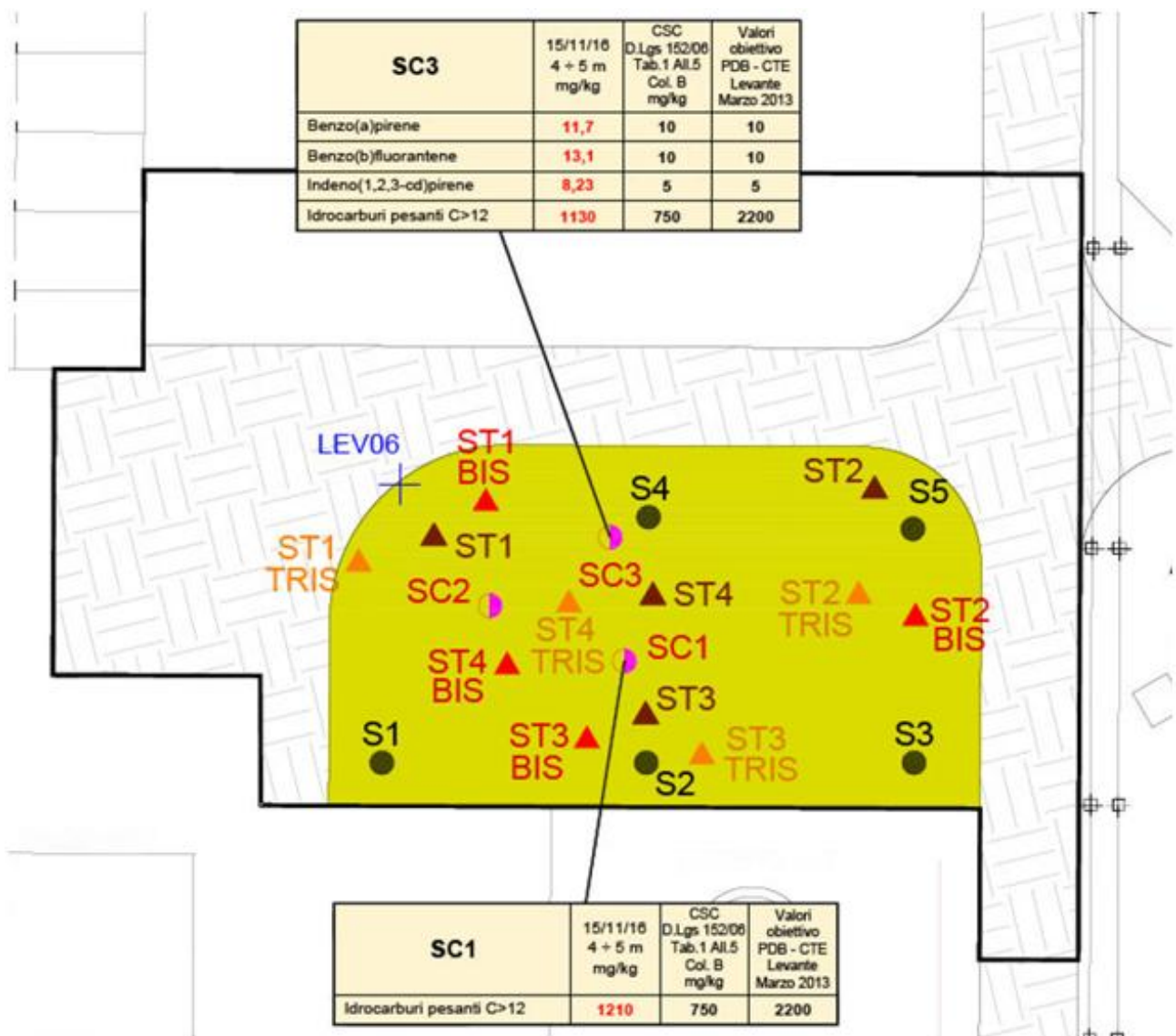

Survey of 2016

### Second course of treatment

Considering the specific lithological conditions and the state of contamination found in the area in question it was chosen to use sodium persulfate ( $\text{Na}_2\text{S}_2\text{O}_8$ ), an oxidizing product with greater ability to permeate the subsoil than the RegenOx already

employed. In addition, in the light of the need to make multiple injection; campaigns or it, it was decided to carry out the application of the oxidizing mixture through a network of injection wells specially realized. The 10 injection points, sequentially named P1 - P10 were distributed according to a regular mesh of about 2.20 m within the polygons identified by the SC3, ST4 and ST4tris probes. They were manufactured through the use of a drilling machine Atlas Copco up to 5.0 m from the ground level, to intercept the layer of soil between 4.0 and 5.0 m in depth where the overcoming of the CSCs were highlighted. At the end of the drilling activity, the boreholes were equipped with a piezometer using 3" HDPE pipes, 5.0 m long. In all piezometers the slotted portion (slot = 0.5 mm) extends for 1.5 m starting from the bottom of the hole, while the remaining 3.5 m part is blind. A drainage mantle with pre-calibrated gravel ( $\varnothing = 2$  mm) from about 0.3 m above the "top" of the filtered section to the bottom of the hole was prepared in the hole/pipe interspace. To ensure a proper insulation by the penetration of surface water and to prevent the possible ascent to the surface of the oxidizing solution during the injection operations, over the drain core were paid, in sequence, a 0.5 m layer of bentonite pellets and cement mortar up to 0.3 m from ground level.

At each injection point, 400 l of reagent was injected into the soil, resulting from the mixing of Sodium Persulfate at 15% and Caustic Soda at 25% according to the following proportions:

- 50 kg of Sodium Persulfate ( $\text{Na}_2\text{S}_2\text{O}_8$ ) at 15% in 350 l of water;
- 15 kg of Caustic Soda at 25% in 50 l of water.

The two substances, solid powder the sodium persulfate and liquid the caustic soda, were previously mixed with water in separate tanks in order to minimize the probability of triggering of exothermic reactions dangerous for operators and, only subsequently, mixed together in a common tank. The mixing of the substances was carried out by means of a manual electric mixer with stainless steel stirrers and was continued until their complete or homogenization.

The injection took place by means of a dedicated automatic unit consisting of a piston motor pump and a sealing cap screwed to the wellhead. The injection pressure was constantly monitored and kept less than 2 bar to prevent the flowing back of the substance in neighbouring injection points. Respecting this modality, the only visible effect of the injections was an increase in the local piezometric level of about 0.5 m. In May 2017, 10 injection points were distributed, according to a regular mesh inside of the polygons identified surveys SC3, ST4 and ST4tris as indicated in the following figure.

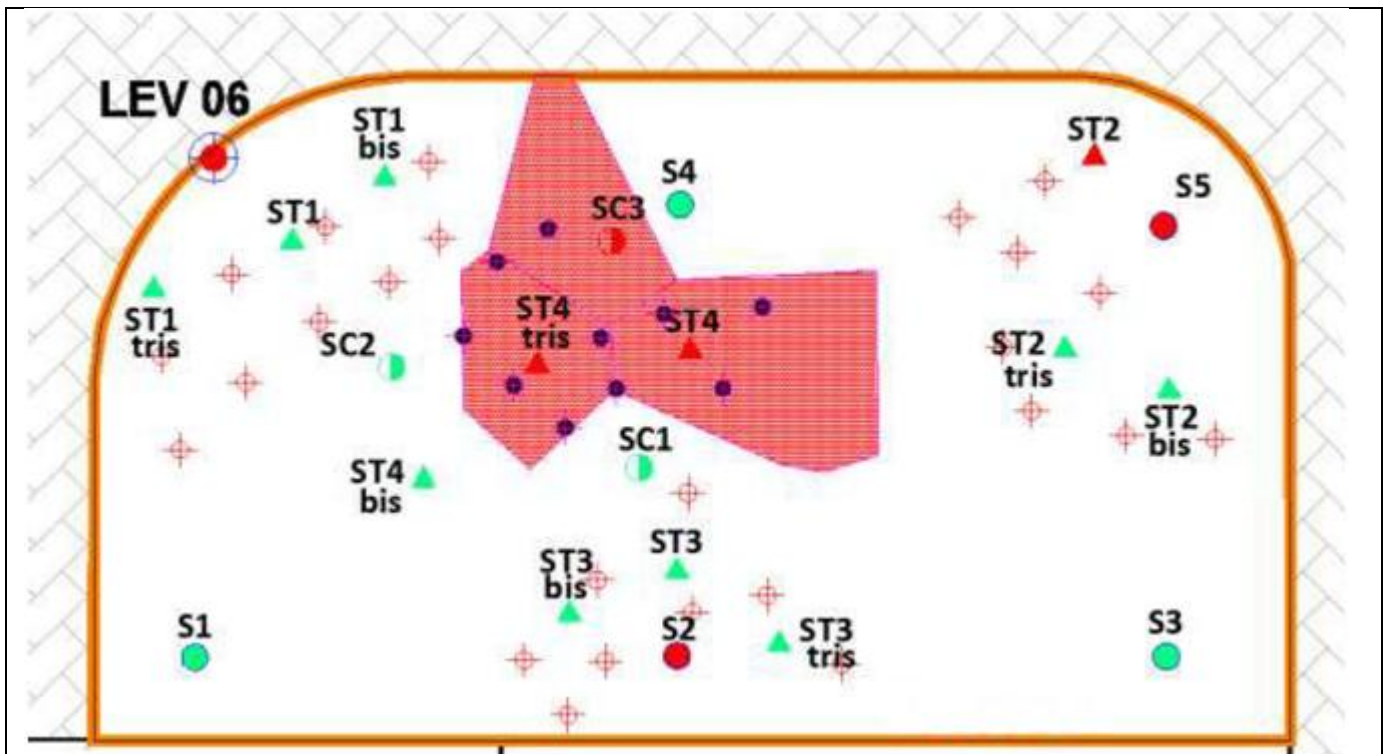

New injection points

Once the new network of injection points had been developed, the first ISCO intervention took place on the 10 injection points on 29, 30 and 31 May 2017 and the second intervention took place on 3 and 4 July 2017. Subsequently, on August 9, 2017 a land monitoring campaign was carried out that showed the presence of PAHs and heavy hydrocarbons ( $C > 12$ ) in concentrations superior to remediation targets in the range of a depth of only between 4.0 m and 5.0 m in depth only, corresponding to saturated soils, and for the monitoring points SMI\_1 and SMI\_3 only. Instead, at the same depth, the SMI\_2 sample presented concentrations of heavy hydrocarbons in excess respect to the CSC reference but lower than the CSR reference. Finally all the samples from the survey SMI\_4 showed concentrations of the sought parameters lower than the reference CSC.



SMI_3	09/08/17 4 + 5 m mg/kg	CSC D.Lgs. 152/06 Tab. 1 All.5 Col. B mg/kg	Valori obiettivo PCB - CTE Levante Mazzo 2013
Benzo(a)antracene	25,3	10	10
Benzo(a)pirene	21,3	10	10
Benzo(b)fluorantene	17,8	10	10
Benzo(g,h,i)perilene	12,0	10	10
Indeno(1,2,3-cd)pirene	11,7	5	5
∑ idrocarburi polic. aromatici	167	100	-
Idrocarburi pesanti C>12	4050	750	2200

SMI_2	09/08/17 4 + 5 m mg/kg	CSC D.Lgs. 152/06 Tab. 1 All.5 Col. B mg/kg	Valori obiettivo PCB - CTE Levante Mazzo 2013
Idrocarburi pesanti C>12	1740	750	2200



SMI_1	09/08/17 4 + 5 m mg/kg	CSC D.Lgs. 152/06 Tab. 1 All.5 Col. B mg/kg	Valori obiettivo PCB - CTE Levante Mazzo 2013
Benzo(a)antracene	26,7	10	10
Benzo(a)pirene	27,2	10	10
Benzo(b)fluorantene	25,4	10	10
Benzo(k)fluorantene	13,0	10	10
Benzo(g,h,i)perilene	16,5	10	10
Indeno(1,2,3-cd)pirene	13,8	5	5
∑ idrocarburi polic. aromatici	203	100	-
Idrocarburi pesanti C>12	7120	750	2200

Point with concentration higher than the remediation target

From the outcomes of the executed campaigns it should be noted that the oxidation intervention resulted only partially effective in the treatment of contamination from heavy hydrocarbons and IPA in the saturated soils, between 4.0 m and 5.0 m in depth. This occurred even if an increase in the reagent dosage and more soluble mixtures were adopted. The verification investigations have in fact highlighted a residual contamination in the soils characterized by the presence of high concentrations of heavy hydrocarbons and PAHs in a localized portion of the subsoil around the monitoring points SMI\_1 and SMI\_3.

In light of the results achieved, it was necessary to evaluate the state of affairs of the area by means of a testing activity aimed at defining the portions of land that have



achieved the objectives and those that still present residual concentrations, higher than those foreseen in the authorized project.  
 Finally, the persistence of concentrations exceeding the target value was resolved with a risk analysis.

## 5.2 Additives

In the case of oxidant complex RegenOx™, consisting of a mixture of percarbonate of sodium and an activating complex constituted by a mixture of sodium silicate, silica gel and ferrous sulfate. It appears as a liquid gel.  
 Instead, in the case of Sodium Persulfate ( $\text{Na}_2\text{S}_2\text{O}_8$ ), Caustic Soda ( $\text{NaOH}$ ) has been added.

## 5.3 Injection type

The methods of injection of the oxidant are described in section 4.1  
 The figures below describe the different phases of treatment.

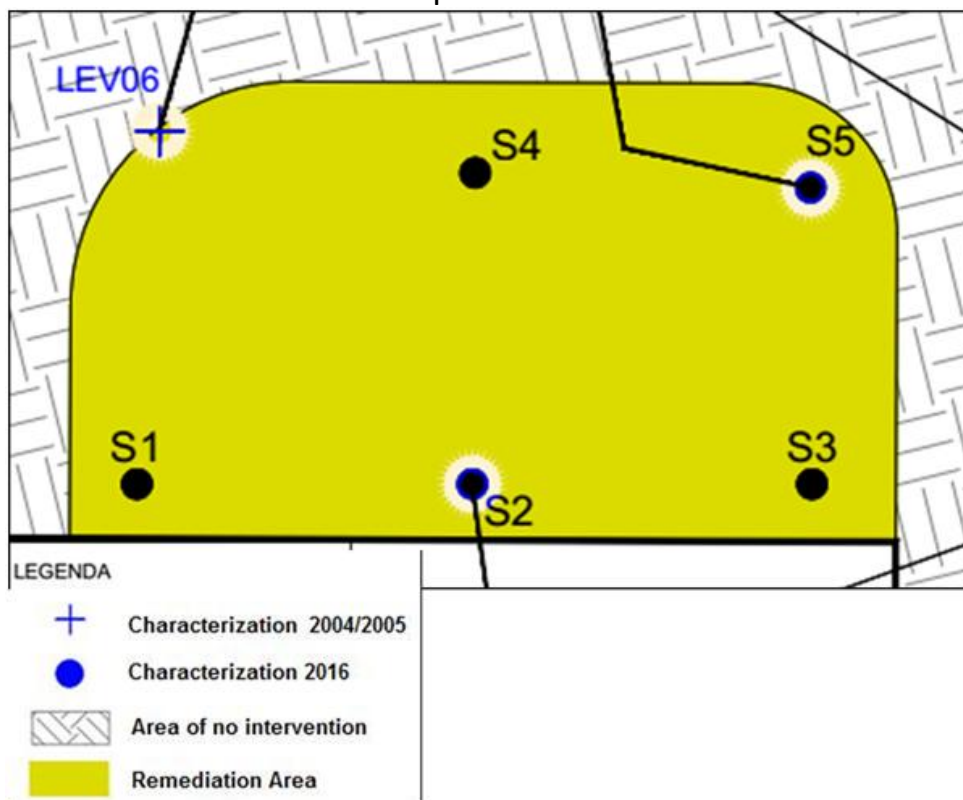

Survey contaminated by LEV06 characterization and integrative surveys to limit the intervention area



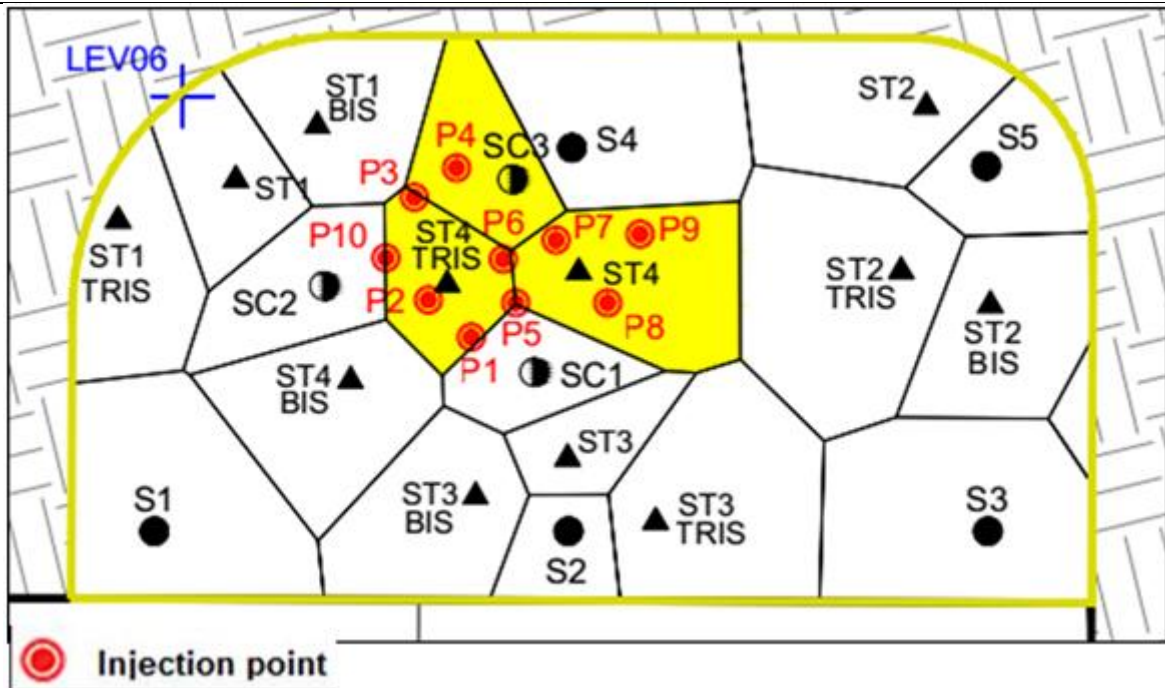

Second cycle of treatment with sodium persulfate

- Information on the injection layer is given in paragraph 2.3
- Information about to the number of injection campaigns (how many campaigns, timing, dosages) and the dosage of the ISCO agent are reported in section 4.1
- No injection enhancement system was used.

The following table shows a summary of the activities performed

Summary of the activities performed		
Activity	Task	Date
<b>January 2016 - November 2016</b>		
Setting up of the construction site area	1. Setting up of the construction site area 2. Laying of the fences	26/01/2016
Additional characterization of the LEV06 parcel of the area	1. Drilling activity 2. Supervision of soil sampling activities 3. Laboratory analysis	26 and 27/01/2016
Injection of oxidant (RegenOx)	1. Preparation of the oxidizing mixture 2. Direct push into the soil	First stage 30+31/05/2016 and 01/06/2016 Second stage 11+13/07/2016



Monitoring of the remediation progress	<ol style="list-style-type: none"> <li>1. Drilling activity</li> <li>2. Supervision of soil sampling activities</li> <li>3. Laboratory analysis</li> </ol>	First investigation campaign 01/08/2016 Second investigation campaign 12/08/2016 Third investigation campaign 29/08/2016
Additional characterization	<ol style="list-style-type: none"> <li>1. Drilling activity</li> <li>2. Supervision of soil sampling activities</li> <li>3. Laboratory analysis</li> </ol>	
<b>May 2017 – August 2017</b>		
Location of injection points and construction of piezometers	<ol style="list-style-type: none"> <li>1. Identification of underground utilities</li> <li>2. Location of injection points</li> <li>3. Execution of drilling</li> <li>4. Installation of piezometers</li> <li>5. Piezometer development</li> </ol>	22+23+24/05/2017 29/05/2017
Injection of oxidant (Sodium Persulfate)	<ol style="list-style-type: none"> <li>1. Preparation of the oxidizing mixture</li> <li>2. Injection activity</li> </ol>	First stage 29+31/05/2017 Second stage 03+04/07/2017
Monitoring of the remediation progress	<ol style="list-style-type: none"> <li>1. Drilling activity</li> <li>2. Supervision of soil sampling activities</li> <li>3. Laboratory analysis</li> </ol>	First investigation campaign 09/08/2017



## 5.4 Radius of influence

Additional surveys were planned to precisely limit the extent of the contamination of the area, within the intervention area defined on the basis of the Thiessen polygon. The boreholes were arranged with a regular mesh (15 m x 15 m) around point LEV06. The perforations were pushed up to the “Caranto” (local name of a Pleistocene paleosol consisting of an extremely compact, silty-sandy clay), the top of which is located in this area at a depth of approximately 4.5 m from the ground level. One sample per meter of thickness crossed was taken, to be analyzed in the laboratory.

Based on the analytical results, the area to be treated was defined and the quantities of contaminants present were estimated.

The range of influence has not been calculated. An estimate It was made from literature data as a function of low permeability of the soil and the test was carried out on a pilot-scale according to the supplementary characterization performed as in the first figure of the previous paragraph 4.3, verifying the effectiveness of the treatment as per the following paragraph

## 5.5 Process and performance monitoring

To assess the actual degradation of the contaminant in the first injection cycle and for possibly define some corrective manoeuvres, samples of soils within the injection area were carried out fortnightly, during the 45 days following the injection.

In the second treatment cycle, the first check of the remediation progress was performed approximately 30 days after the last injection.



## 6. Post treatment and/or Long Term Monitoring

### 6.1 Post treatment and/or Long Term Monitoring

In the case study described, it was not necessary to provide for long-term monitoring due to the low mobility of the contaminants.

## Glossary of Terms

<b>Term (alphabetical order)</b>	<b>Definition</b>
CSC	Contamination threshold concentrations
CSR	Risk threshold concentrations
NAPL	Non-Aqueous Phase Liquids
SIN	Site of National Interest
VCM	Vinyl Chloride Monomer