



European Union Network for the Implementation
and Enforcement of Environmental Law



Working Group
Contamination

Relatório – Oxidação Química In Situ (ISCO)

Relatório Final

Data do relatório: 8 de novembro de 2021

Número do relatório: 2020/09 ISCO PT

Introdução à IMPEL

A Rede da União Europeia para a Implementação e Execução da Legislação Ambiental (IMPEL) é uma associação internacional sem fins lucrativos das autoridades ambientais dos Estados-Membros da UE, dos países aderentes e dos países candidatos da União Europeia e dos países do EEE. A associação está registada na Bélgica e a sua sede legal é em Bruxelas, Bélgica.

A IMPEL foi criada em 1992 como uma rede informal de reguladores e autoridades europeias preocupadas com a implementação e aplicação da legislação ambiental. O objectivo da Rede é criar o impulso necessário na Comunidade Europeia para avançar no sentido de assegurar uma aplicação mais eficaz da legislação ambiental. O núcleo das actividades da IMPEL diz respeito à sensibilização, ao desenvolvimento de capacidades e à troca de informações e experiências sobre implementação, aplicação e colaboração internacional na aplicação da legislação ambiental, bem como à promoção e apoio à praticabilidade e aplicabilidade da legislação ambiental europeia.

Durante os anos anteriores, a IMPEL tornou-se uma organização considerável e amplamente conhecida, sendo mencionada numa série de documentos legislativos e políticos da UE, por exemplo, o 7º Programa de Acção Ambiental e a Recomendação sobre os Critérios Mínimos para as Inspeções Ambientais.

A perícia e experiência dos participantes no seio da IMPEL tornam a rede excepcionalmente qualificada para trabalhar tanto nos aspectos técnicos como regulamentares da legislação ambiental da UE.

A informação sobre a Rede IMPEL está também disponível através do seu sítio web em: www.impel.eu

Suggested citation:

Falconi M. et al. (2021), Relatório – Oxidação Química In Situ (ISCO). IMPEL, COMMON FORUM, EIONET, NICOLE report no 2020/09 ISCO PT, 279 pages. Brussels, ISBN 978-2-931225-22-6



Título do relatório: Relatório – Oxidação Química In Situ (ISCO)	Número do relatório: 2020/09 ISCO PT	
Relatório adoptado na Reunião da Assembleia Geral da IMPEL: 7-8 de dezembro de 2021, Ljubljana (Eslovénia)	Número total de páginas: 279	
	Relatório: 56 páginas Anexos: 223 páginas	
Gestores de projecto:		
Marco Falconi (IT)	IMPEL	ISPRA
Dietmar Müller-Grabherr (AT)	Common Forum	Umweltbundesamt AT
Frank Swartjes (NL)	EIONET WG Contamination	RIVM
Tomás Albergaria (PT)	NICOLE	Instituto Politécnico do Porto
Autores:		
Frank Swartjes (NL)	EIONET WG Contamination	RIVM
Francesca Benedetti (IT)	IMPEL	MITE
João Paulo Bettencourt (PT)		Inspeção Regional do Ambiente
Nazaré Couto (PT)		NOVA FCT, CENSE
Joaquim Esteves da Silva (PT)		FCUP
Emanuela Fabbrizi (IT)	IMPEL	ARPAE
Marco Falconi (IT)	IMPEL	ISPRA
Gabriella Grima (MT)	IMPEL	ERA
Daniel Gruza (CZ)	IMPEL	CIPZ
Maria Mallada (ES)	IMPEL	LA RIOJA
Christina Pisani (MT)	IMPEL	ERA
Alex Plows (UK)	IMPEL	CYFOETHNATURIOLCYMRU
Roberto Riberti (IT)	IMPEL	ARPAE
Paola Siligardi (IT)	IMPEL	ARPAE
Asa Valley (SE)	EIONET WG Contamination	NATURVÅRDSVERKET
Contribuidores do Anexo 1 ISCO:		
Simone Biemmi (IT)	ARCADIS ITALIA	
Gordon H. Bures (DE)	SENSATEC	
Federico Caldera (IT)	MARES	
Marcello Carboni (IT)	REGENESIS	
Massimiliano Confalonieri (IT)	ARPA LOMBARDIA	
Mara Dal Santo (IT)	STANTEC	
Federica Danesin (IT)	ARPAV	
Uwe Dannwolf (DE)	RISKCOM	
Federica De Giorgi (IT)	GOLDER ASSOCIATES	
Boris Devic-Bassaget (FR)	SUEZ RR IWS REMEDIATION FRANCE	
Hans-Georg Edel (DE)	ZÜBLIN UMWELTECHNIK	
Peter Freitag (AT)	KELLER GRUNDBAU	
Alberto Leombruni (IT)	EVONIK	
Camille Lorant (FR)	SUEZ RR IWS REMEDIATION FRANCE	
Angela Rosa Marin (IT)	ARPA LOMBARDIA	
Juan Marti (ES)	SUEZ RR IWS IBERICA	

Mike Mueller (AT)	EVONIK
Harald Opdam (NL)	HEIJMANS INFRA BV
Sara Puricelli (IT)	ARPA LOMBARDIA
Diego Ricci (IT)	ARPA LOMBARDIA
Hadas Sharon (IL)	LUDAN ENVIRONMENTAL TECHNOLOGIES
Valentina Sammartino (IT)	ARPA CAMPANIA
Christelle Tarchalski (FR)	ARTELIA
Laura Valeriani (IT)	GOLDER ASSOCIATES
Revisores:	
Gordon H. Bures (DE)	SENSATEC
Marcello Carboni (IT)	REGENESIS
Uwe Dannwolf (DE)	RISKCOM
Mara Dal Santo (IT)	STANTEC
Harald Opdam (NL)	HEIJMANS INFRA BV
Sumário Executivo	
<p><i>Palavras-chave</i> Oxidação Química <i>in situ</i>, Remediação Sustentável, Solo, Águas Subterrâneas, Política do Solo, Remediação, Ambiente, <i>No net land take</i>, Poluição, Locais poluídos, Contaminação, Locais contaminados, Monitorização, teste de campo.</p> <p><i>Grupos-alvo</i> Autoridades competentes para aprovação/aplicação/monitorização de tecnologias de remediação, operadores industriais, agências de proteção ambiental, organismos de proteção da natureza, inspeções ambientais, monitorização ambiental, e instituições de investigação, universidades técnicas, associações ambientais, ONG, companhias e associações de seguros, consultores ambientais.</p> <p>Como parte do seu Programa de Trabalho 2020, a Rede IMPEL criou este projeto de Remediação de Água e de Solo (2020/09), relativo aos critérios de avaliação da aplicabilidade das tecnologias de remediação.</p> <p>O projeto de Remediação da Água e do Solo toma orientações sobre definições e passos chave da aplicação da tecnologia de remediação como um trampolim e concentra-se nos procedimentos técnicos relacionados com as tecnologias de remediação. O objetivo final do projeto é produzir um documento comprovativo dos critérios de avaliação da proposta de aplicação da tecnologia de remediação, para compreender a aplicabilidade, o que fazer nos testes de campo, e na aplicação à escala real. O Anexo 1 abrange uma série de estudos de caso, que podem ajudar o leitor a antecipar quaisquer problemas que possa encontrar e ver se a solução fornecida se aplica ao seu local, sabendo que cada local contaminado difere dos outros e que é sempre necessária uma abordagem específica ao local.</p> <p>O projeto de Remediação da Água e do Solo para 2020-2021 tem como objetivo concentrar-se em duas tecnologias de remediação, a Oxidação Química <i>In Situ</i> e a Extração de Vapores do Solo.</p> <p>Finalmente, o projeto de Remediação de Água e de Solo pretende contribuir para promover a aplicação de tecnologias de remediação <i>in situ</i> e no local para o solo e águas subterrâneas, e a menor aplicação de Cavar e Despejar (Dig & Dump) e Bombear e Tratar (Pump & Treat) que são técnicas amplamente utilizadas na Europa, mas não sustentáveis a médio/longo prazo. O solo e a água são recursos naturais e, quando é tecnicamente viável, devem ser recuperados e não desperdiçados.</p>	

Agradecimentos

Este relatório foi revisto por uma equipa do projeto IMPEL mais vasta e pelo Grupo de Peritos da IMPEL em Água e Solo, rede do Common Forum, rede NICOLE, EIONET WG Contamination e um grupo de revisores externos.

Aviso Legal

Esta publicação foi preparada no âmbito do projeto da IMPEL de Remediação de Água e de Solo com o apoio de redes parceiras interessadas na Gestão de Solos Contaminados. Escrito e revisto por uma equipa de autores, o documento em questão pretende servir como fonte primária de informação para aproximar e alargar o conhecimento entre países e regiões europeias. Ao visar o apoio a uma compreensão conjunta das potencialidades da tecnologia de remediação específica que procura facilitar.

O conteúdo aqui relatado é baseado na bibliografia relevante, na experiência dos autores, e em estudos de caso recolhidos. O documento pode não ser extenso em todas as situações em que esta tecnologia tenha sido ou venha a ser aplicada. Os estudos de caso (ver anexo) são contribuições voluntárias reconhecidas. A equipa de autores não teve qualquer tarefa como a avaliação ou verificação de relatórios de estudos de caso.

Além disso, alguns países, regiões ou autoridades locais podem ter lançado legislação, regras ou diretrizes específicas para enquadrar a aplicação da tecnologia e a sua aplicabilidade.

Este documento NÃO pretende ser uma orientação ou um documento de referência MTD para esta tecnologia. Os cenários pedológicos, geológicos e hidrogeológicos de locais contaminados em toda a Europa mostram uma grande variabilidade. Por conseguinte, a concepção e a implementação feitas à medida de cada local é fundamental para o sucesso na remediação de locais contaminados. Assim, qualquer recomendação relatada poderia ser aplicada, parcialmente aplicada, ou não aplicada. Em qualquer caso, os autores, os contribuidores, as redes envolvidas, não podem ser considerados responsáveis.

As opiniões expressas no presente documento não são necessariamente as dos membros individuais das redes abaixo assinadas. A IMPEL e as suas redes de parceiros recomendam vivamente que as pessoas/organizações interessadas em aplicar a tecnologia na prática retenham os serviços de profissionais ambientais experientes.

Marco Falconi – IMPEL

Dietmar Müller Grabherr – COMMON FORUM on Contaminated Land in Europe

Frank Swartjes – EEA EIONET WG Contamination

Tomás Albergaria – NICOLE

Glossário

TERMO	DEFINIÇÃO	FONTE	PARAGR.
‘ponto de conformidade’	local (por exemplo, solo ou águas subterrâneas) onde os critérios de avaliação devem ser medidos e não devem ser excedidos	ISO EN 11074	3.4.5
‘conformidade ou controlo de desempenho’	investigação ou programa de inspeção, teste ou monitorização em curso para confirmar que uma estratégia de remediação foi devidamente implementada (por exemplo, todos os contaminantes foram removidos) e/ou quando foi adotada uma abordagem de contenção, que esta continua a funcionar ao nível especificado	ISO EN 11074	6.1.5
‘contaminante’ ¹	substância(s) ou agente(s) presente(s) no solo como resultado da atividade humana	ISO EN 11074	3.4.6
‘local contaminado’ ²	local onde a contaminação está presente	ISO EN 11074	2.3.5
‘contaminação’	substância(s) ou agente(s) presente(s) no solo como resultado da actividade humana	ISO EN 11074	2.3.6
‘eficácia’ ³	<método de remediação> medida da capacidade de um método de remediação para atingir um desempenho exigido	ISO EN 11074	6.1.6
‘emissão’	a libertação direta ou indireta de substâncias, vibrações, calor ou ruído de fontes individuais ou difusas na instalação para o ar, água ou solo;	IED	Art. 3 (4)
‘norma de qualidade ambiental’	o conjunto de requisitos que devem ser preenchidos num determinado momento para um determinado ambiente ou parte específica deste, tal como estabelecido no direito da União;	IED	Art. 3 (6)
‘Coeficiente de Henry’	coeficiente de partição entre o ar do solo e a água do solo	ISO EN 11074	3.3.12
‘método de tratamento <i>in situ</i> ’ ⁴	método de tratamento aplicado diretamente ao meio ambiente tratado (por exemplo, solo, águas subterrâneas) sem extração da matriz contaminada do solo	ISO EN 11074	6.2.3
‘lixiviação’	dissolução e movimento de substâncias dissolvidas em água	ISO EN 11074	3.3.15

¹ Não há nenhum pressuposto nesta definição que prejudique os resultados da presença de contaminação

² Não há nenhum pressuposto nesta definição que prejudique os resultados da presença de contaminação

³ No caso de um método baseado num processo, a eficácia pode ser expressa em termos das concentrações residuais de contaminantes conseguidas.

⁴ Nota: ISO CD 241212 sugere como sinónimo: ‘técnica in-situ (remediação)’ [Nota 1 à entrada: Tal instalação de remediação é colocada no local e a acção de tratamento do contaminante destina-se a ser directamente aplicada no subsolo]. ISO CD 24212 3.1

‘poluente’	substância(s) ou agente(s) presente(s) no solo (ou nas águas subterrâneas) que, devido às suas propriedades, quantidade ou concentração, causa impactos adversos nas funções do solo	ISO EN 11074	3.4.18
‘poluição’	a introdução direta ou indireta, como resultado da atividade humana, de substâncias, vibrações, calor ou ruído no ar, água ou solo que possam ser prejudiciais para a saúde humana ou para a qualidade do ambiente, resulte em danos a bens materiais, ou prejudique ou interfira com as amenidades e outras utilizações legítimas do ambiente;	IED	Art. 3 (2)
‘objetivo de remediação’	termo genérico para qualquer objetivo, incluindo os relacionados com os requisitos técnicos (por exemplo, concentrações de contaminação residual, desempenho de engenharia), administrativos e legais	ISO EN 11074	6.1.19
‘estratégia de remediação’ ⁵	combinação de métodos de remediação e trabalhos associados que irão cumprir objetivos específicos relacionados com a contaminação (por exemplo, concentrações residuais de contaminantes) e outros objetivos (por exemplo, relacionados com a engenharia) e ultrapassar restrições específicas do local	ISO EN 11074	6.1.20
‘valor-alvo de remediação’	indicação do desempenho a alcançar por remediação, geralmente definido como objetivo relacionado com a contaminação em termos de uma concentração residual	ISO EN 11074	6.1.21
‘zona saturada’	zona do solo na qual o espaço poroso está completamente preenchido com líquido no momento da consideração	ISO EN 11074	3.2.6
‘solo’	a camada superior da crosta terrestre situada entre o leito rochoso e a superfície. O solo é composto por partículas minerais, matéria orgânica, água, ar e organismos vivos;	IED	Art. 3 (21)
‘gás do solo’	gás e vapor nos espaços dos poros dos solos	ISO EN 11074	2.1.13
‘zona insaturada’	zona do solo na qual o espaço poroso não está completamente preenchido com líquido no momento da consideração	ISO EN 11074	3.2.8

NOTA: Na presente versão do relatório em português mantiveram-se as siglas originais, em língua inglesa.

⁵ A escolha de métodos pode ser limitada por uma variedade de factores específicos do local, tais como topografia, geologia, hidrogeologia, propensão a inundações e clima

ÍNDICE

1	INTRODUÇÃO	10
2	DESCRIÇÃO DA TÉCNICA	13
2.1	Fases ISCO	14
2.2	Caraterísticas dos DNAPL	16
2.2.1	Volatilidade	17
2.3	Oxidação de poluentes	18
2.3.1	Agente oxidante	18
2.4	A ISCO em contexto	22
3	ESTUDO DE VIABILIDADE	27
3.1	Definição de objetivos	27
3.2	Aplicabilidade da ISCO	27
3.2.1	Carência de oxidantes	29
3.2.2	Características lito-estratigráficas e hidrogeológicas do sítio	31
3.2.3	Presença de infra-estruturas	32
3.3	Segundo rastreio	32
3.4	Tratabilidade dos contaminantes	34
4	TESTE DE CAMPO/EM LABORATÓRIO	35
4.1	Aspetos de conceção	35
4.1.1	Escolha do tipo de oxidante	35
4.1.1.1	Cinética da reacção	35
4.1.1.2	Geologia e hidrogeologia	35
4.1.1.3	Carência de oxigénio nas águas subterrâneas e no aquífero (NOD)	36
4.1.1.4	pH	37
4.1.1.5	Fração de matéria orgânica (f_{oc})	37
4.1.1.6	Concentração de contaminantes	38
4.1.1.7	Compatibilidade ambiental dos oxidantes	38
4.1.2	Quantidade de oxidante	39
4.1.2.1	Contaminantes de interesse	39
4.1.2.2	Matriz	39
4.1.2.3	Determinação da carência de oxidante	40
4.1.3	Entrada do agente oxidante	40
4.1.4	Volumes de reagente a injetar	40
4.1.5	Acessibilidade da área de intervenção	41

4.1.6	Tecnologias de injeção	41
4.2	Testes laboratoriais e testes-piloto	46
4.2.1	Ensaio de bancada	46
4.2.2	Teste piloto	47
4.2.3	Monitorização do processo	47
4.2.4	Monitorização do desempenho	48
4.2.4.1	Indicadores	48
4.2.4.2	Monitorização da rede	48
4.2.4.3	Frequência	49
5	MONITORIZAÇÃO	51
5.1	Tipos de ensaios	51
5.2	Tipos de monitorização	52
5.2.1	Monitorização operacional - tecnológica	52
5.2.2	Monitorização em contínuo e na fase final	52
5.2.3	Monitorização pós-remediação	53
5.2.4	Processamento da análise de risco actualizada após a conclusão da remediação	54
6	CONCLUSÕES	55
	REFERÊNCIAS	56

1 INTRODUÇÃO

A oxidação química *in situ* (ISCO) é uma tecnologia de remediação frequentemente aplicada na remediação de locais contaminados devido à vasta gama de poluentes que podem ser tratados. Consiste na injeção de oxidantes químicos, tais como permanganato, persulfato e peróxido de hidrogénio no subsolo para transformar por oxidação química os poluentes em compostos inofensivos.

A ISCO pode tratar com sucesso poluentes tais como solventes clorados, TPH (Hidrocarbonetos totais de petróleo), BTEX (Benzeno, Tolueno, Etilbenzeno e Xileno), MTBE (éter metilterbutílico), Fenóis, PAH (hidrocarbonetos policíclicos aromáticos) e clorobenzenos.

Na ISCO é conhecido que ocorre oxidação entre estes poluentes e os agentes oxidantes, mas muitos parâmetros têm de ser ajustados. A escolha desta tecnologia de remediação necessita de conhecimentos específicos sobre os poluentes no local, como são distribuídos no subsolo e nas águas subterrâneas, condição geológica e hidrogeológica do local. Cada local tem a sua própria ISCO "à medida". Não é raro ver que a escolha de uma tecnologia é feita após a caracterização preliminar sem ter a informação detalhada, com a ideia de poupar tempo e de começar rapidamente com a remediação. A experiência de algumas décadas de remediação de locais contaminados mostrou-nos que uma caracterização do planeamento da remediação (CDR) é necessária para decidir a tecnologia certa para cada situação e não deve ser feita qualquer generalização sobre a distribuição de contaminantes ou geologia da subsuperfície. Os custos do ciclo de vida do projeto conceptual com e sem CDR são mostrados na Figura 1.1.



Figura 1.1- Custos conceituais do ciclo de vida do projeto com e sem CDR

No esquema acima referido é mostrado o efeito positivo da CDR na redução do tempo e limitação dos custos de todo o processo de remediação, mesmo que o aumento do custo inicial devido à caracterização do local seja considerável.

Assim, o ensaio deve recolher todas as informações úteis para que a oxidação funcione no local; dividir o processo em etapas sucessivas, como mostra o esquema da Figura 1.2, pode ser muito útil.

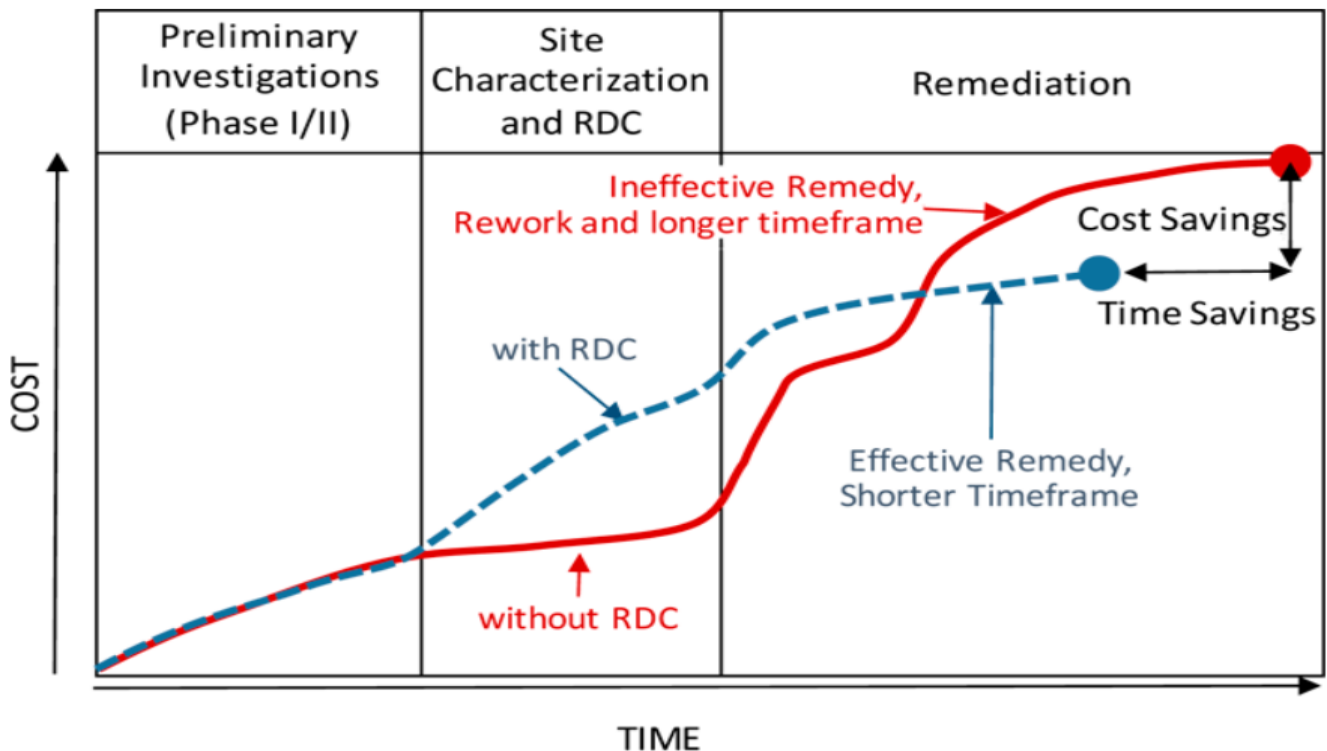

Figura 1.2- Esquema do ITRC (<https://ois-isrp-1.itrcweb.org/>)

A ISCO também pode ser utilizada em combinação com outras tecnologias com diferentes níveis de intensidade e é preferível planejar mais do que um cenário com diferentes desempenhos no que diz respeito às componentes ambientais, sociais e económicas da sustentabilidade (Figura 1.3). As alternativas de planeamento são decididas combinando técnicas de remediação que podem ser aplicadas com lógica espacial (diferentes técnicas em diferentes partes do sítio) ou lógica temporal (sequência de tecnologias na mesma área), ver Figura 1.4. A intensidade de um cenário de tratamento varia de acordo com as diferentes combinações de esforço corretivo ativo e esforço corretivo passivo. Os esforços de remediação ativa baseiam-se na utilização de alta energia e reagentes químicos, enquanto os esforços de remediação passiva envolvem mecanismos biológicos.

Esta abordagem integrada normalmente gera efeitos sinérgicos em todo o projeto de remediação.

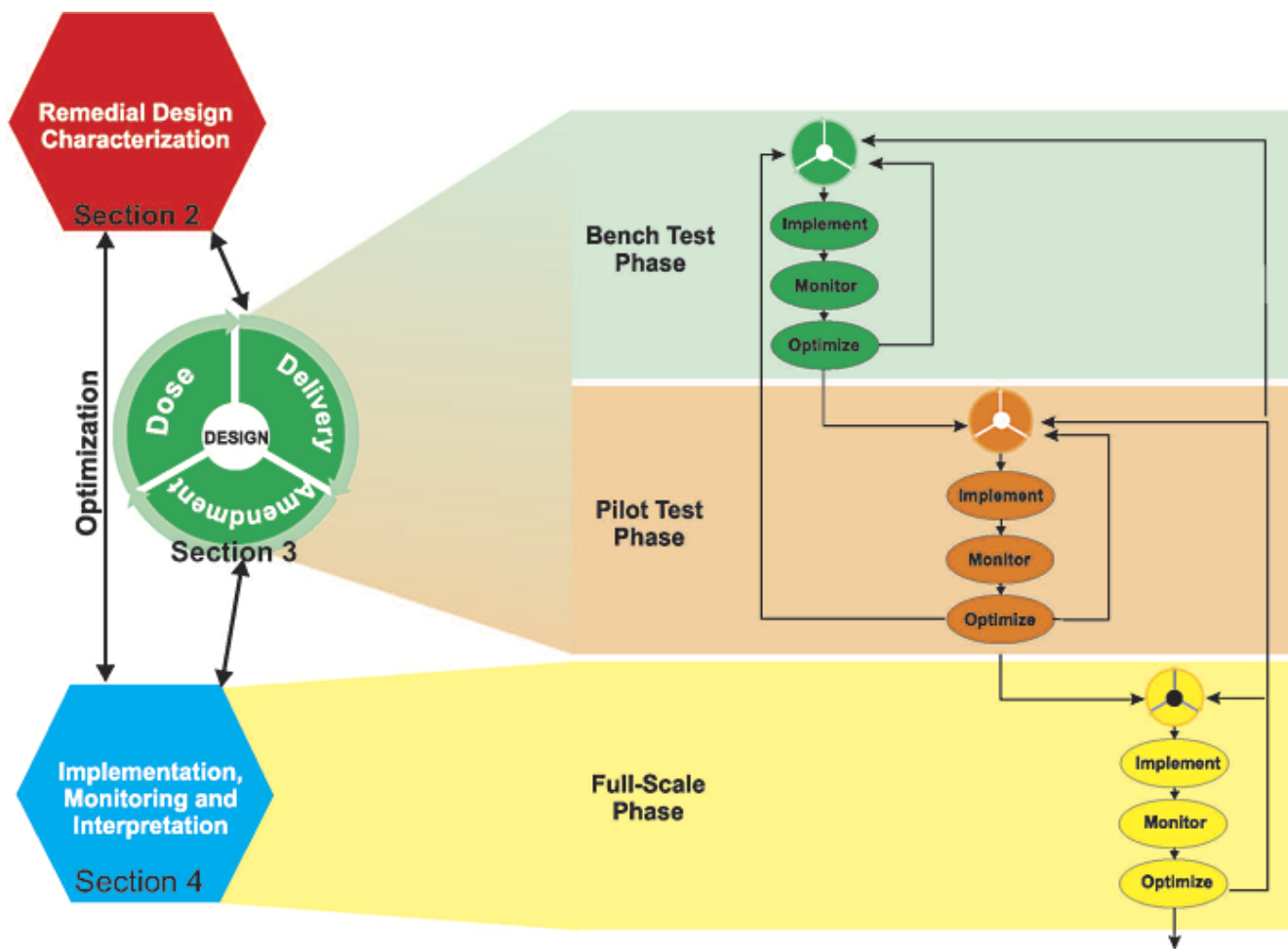

Figura 1.3- Esquema de sustentabilidade



Figura 1.4- Esquema de Tratamento Integrado/ Síntese de Processos de Remediação Combinados (©Regenesis 2016)

Os capítulos seguintes descreverão a técnica e os passos mais importantes que devem ser realizados para alcançar os objetivos de intervenção de remediação. As informações contidas são os resultados de anos de observações experimentais e na prática de campo de conhecimentos teóricos.

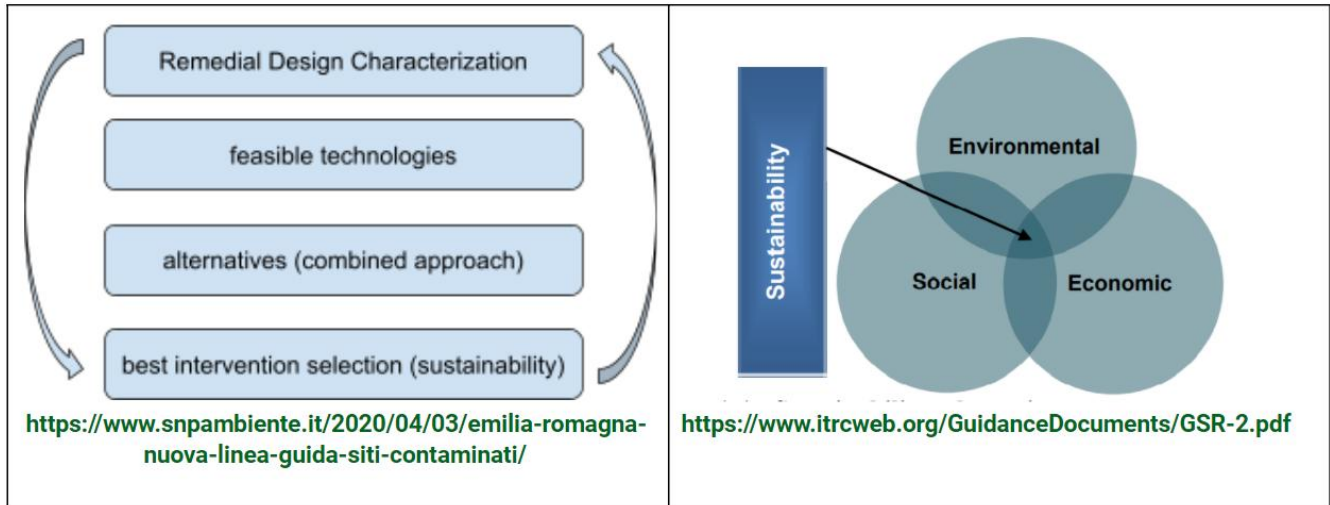
2 DESCRIÇÃO DA TÉCNICA

As técnicas de remediação do solo *in situ* tratam da contaminação do solo e das águas subterrâneas sem necessidade de escavar ou extrair as águas subterrâneas. Como não é necessária qualquer escavação, estas técnicas têm menor impacto na utilização do solo e podem ser aplicadas em vários locais. A composição e a estrutura do solo são também menos afetadas.

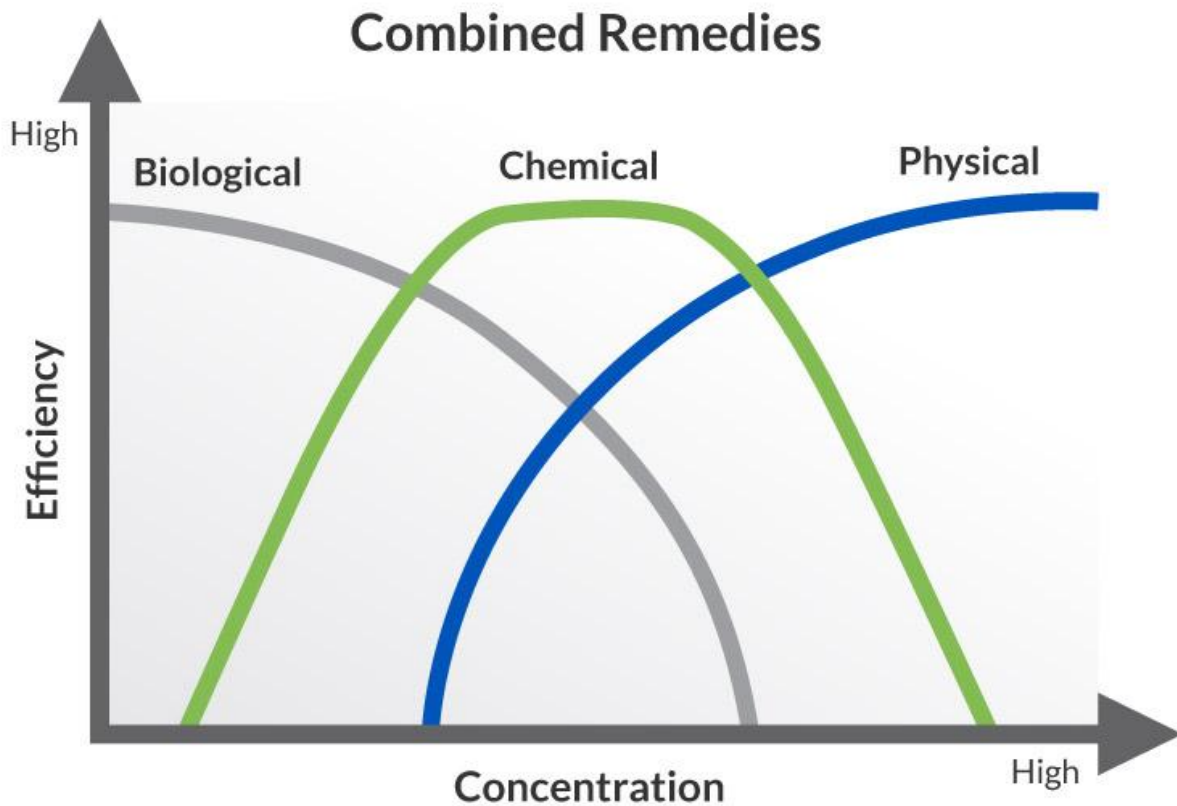
A técnica ISCO utiliza químicos chamados oxidantes (por exemplo, permanganato, persulfato, peróxido de hidrogénio e ozono) para ajudar a converter poluentes perigosos em subprodutos menos tóxicos. É chamada "*in situ*" porque é executada no local, sem ter de escavar o solo ou bombear as águas subterrâneas para a limpeza de superfícies.

Para aplicar a ISCO, um agente oxidante é injectado no subsolo, passa através da sua massa e provoca a destruição química (oxidação) dos poluentes, transformando-os em compostos mais pequenos e menos tóxicos. Os oxidantes são aplicados no subsolo através de método selecionado (para a descrição dos principais métodos de aplicação ver secção 4.1.6). Assim, o agente oxidante atinge a zona contaminada. O foco é tanto nos poluentes dissolvidos como nos não dissolvidos. Uma vez aplicado, o oxidante difunde-se no aquífero onde se mistura e reage com os poluentes. Para este efeito, a secção ou válvulas dos poços devem ser de modo a assegurar um tratamento eficaz da contaminação, para atingir a maior contaminação possível.



Figura 2.1- Esquema ISCO

As principais características da técnica são:

- Reduz significativamente as concentrações com base nos objetivos fixados no âmbito da estratégia de remediação;
- Um produto (agente oxidante) é introduzido no subsolo, distribui-se pela massa do solo e inicia a destruição química (oxidação) dos poluentes em espécies químicas menos nocivas;

- A estrutura do solo permanece intacta.

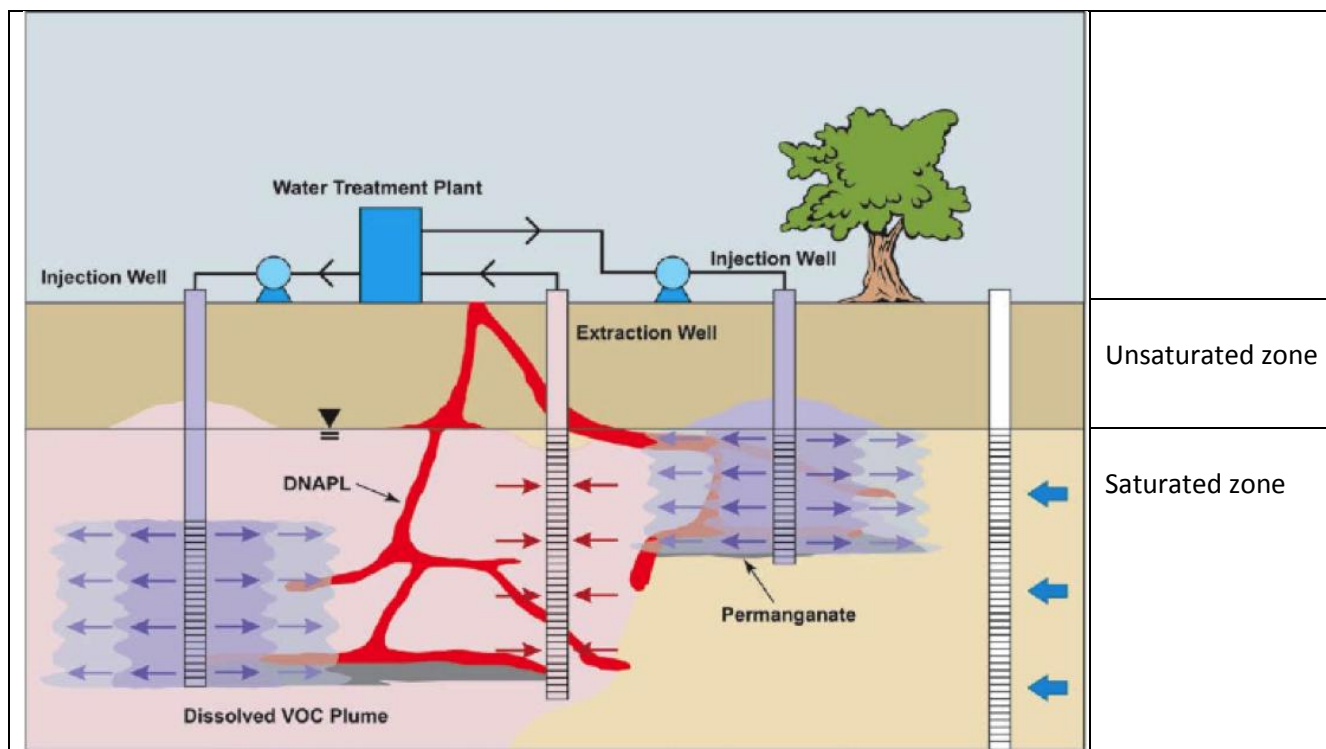

Figura 2.2- Esquema do Sistema de recirculação

<http://en.lifediscovered.es/content/cats/44/iscours2.jpg>

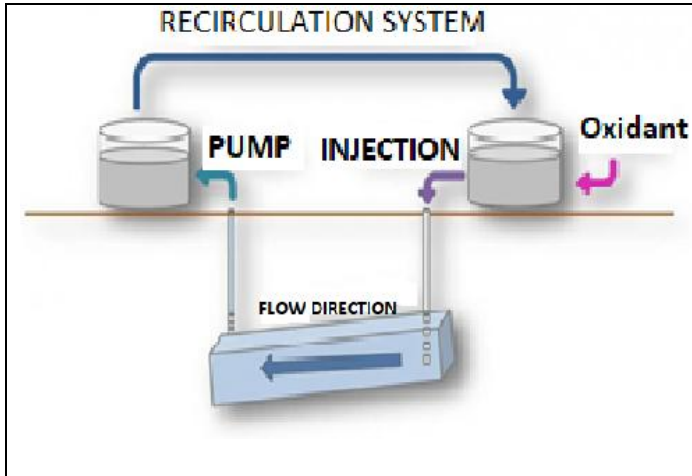
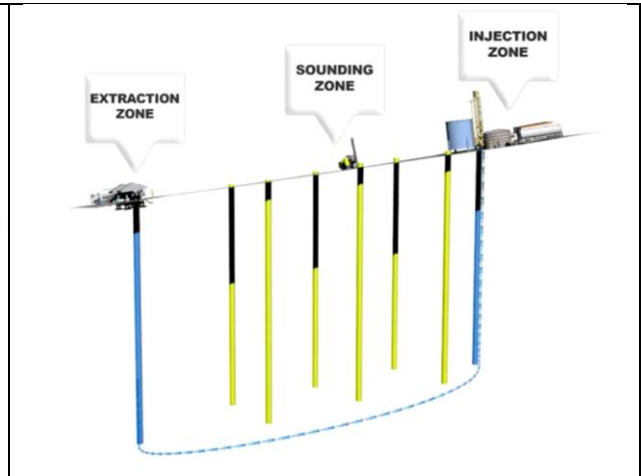

Figure 2.3- Esquema 2D do sistema de recirculação

LIFE DISCOVERED ISCO pilot trial

<https://www.youtube.com/watch?v=3XjU98hi8KM>

2.1 Fases ISCO

O comportamento de um poluente no solo, e a eficiência de uma tecnologia de remediação são determinados por vários fatores que interagem de forma complexa e dependem das características do próprio poluente e do solo. Para selecionar uma tecnologia com boas perspectivas de sucesso, é crucial ter em conta as características tanto do poluente como do local poluído.

As seguintes opções de FASES poderiam ser levadas a cabo para implementar a técnica no local:

1. **SELEÇÃO DA ÁREA DE ATUAÇÃO E DAS INFRA-ESTRUTURAS BÁSICAS:** O sucesso da técnica depende da localização óptima dos poços. Assim, se as localizações ótimas não forem conhecidas, perfurações de poços de injeção, extração e monitorização de teste devem ser efetuadas na área piloto selecionada.
2. **INJEÇÕES:** Após a perfuração, uma solução com um agente oxidante é injetada no poço. Essa solução quebra as ligações C-C dos poluentes. A oxidação química dos poluentes transforma-os em compostos menos perigosos e mais tratáveis.
3. **RECIRCULAÇÃO:** A oxidação dos poluentes depende do tempo de residência do oxidante no subsolo. Quando o tempo de contacto entre a rocha e o oxidante é considerado insuficiente, a solução é bombeada através de um poço e injetada novamente, se necessário. O processo de recirculação será realizado até que a capacidade de oxidação do agente diminua (Figura 2.4).
4. **EXTRAÇÃO:** A atuação será interrompida quando o oxidante já não for eficiente e a concentração de poluentes mostrar uma tendência decrescente. Em seguida, a solução é bombeada e tratada numa estação de tratamento de água adequada.
5. **ACOMPANHAMENTO:** Para avaliar o progresso da ISCO (condições iniciais, intermédias e finais) e o desempenho global do ensaio, é crucial monitorizar parâmetros tais como o potencial de oxidação-redução, condutividade, temperatura, oxidantes e sub-produtos e a concentração de poluentes alvo.

Estas etapas podem ou não ser conduzidas de uma forma sequencial.



Figura 2.4- Esquema 3D do sistema de recirculação



Figura 2.5- Mistura de reagentes antes da injeção

2.2 Características dos DNAPL

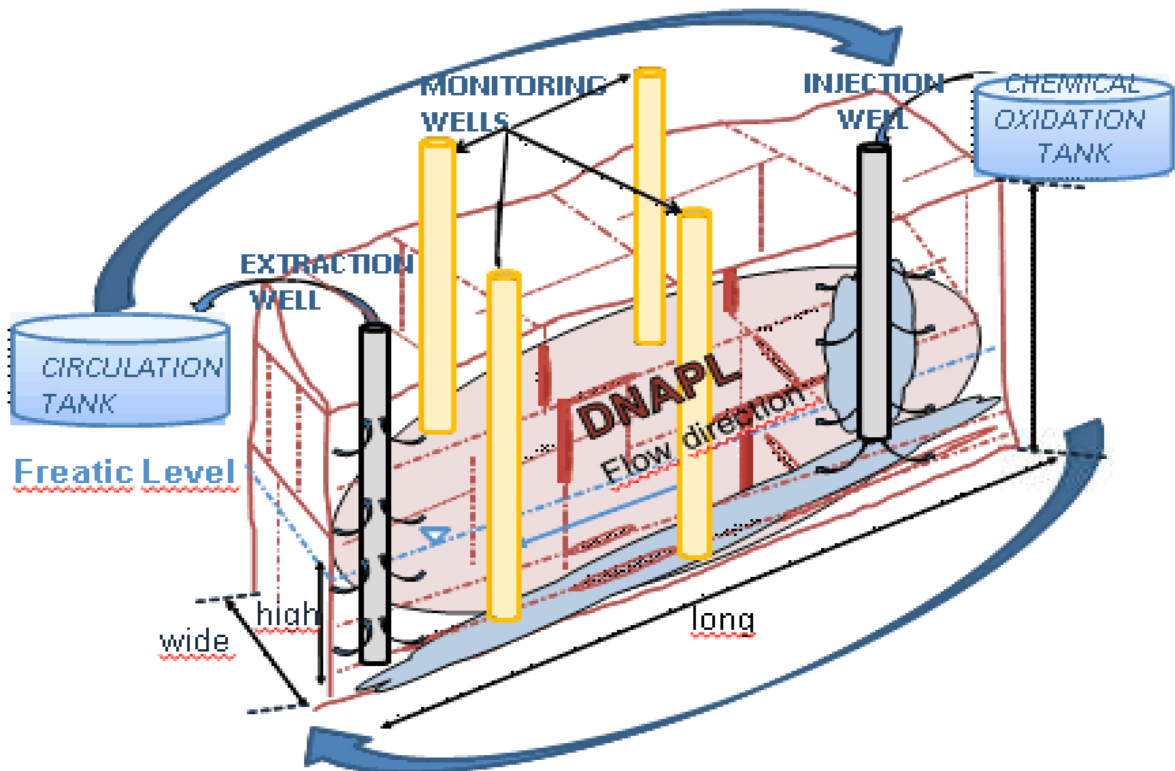
O termo DNAPL (líquidos densos em fase não aquosa) inclui muitos produtos químicos caracterizados por estarem numa fase líquida não aquosa e serem mais densos do que a água. Alguns dos mais importantes são solventes organoclorados, creosote, resíduos de alcatrão de carvão e pesticidas. O DNAPL mais comumente encontrado em locais contaminados são os solventes organoclorados.

De acordo com as propriedades físicas e químicas de um DNAPL, estes são descarregados em quantidades significativas no subsolo. Como resultado, o solo torna-se poluído. O DNAPL desloca-se geralmente para baixo através do solo até eventualmente se acumular em cima de camadas mais impermeáveis. A elevada capacidade de penetração e a complexidade do ambiente natural (heterogeneidade) tornam a contaminação por DNAPL difícil de localizar. Consequentemente, é difícil limpar e restaurar o subsolo.



Figura 2.6- DNAPL

Poluentes: hexaclorobenzeno (HCB), alfa hexaclorociclohexano (α -HCH), beta hexaclorociclohexano (β -HCH), Lindano e pentaclorobenzeno
<https://www.youtube.com/watch?v=3XjU98hi8KM>

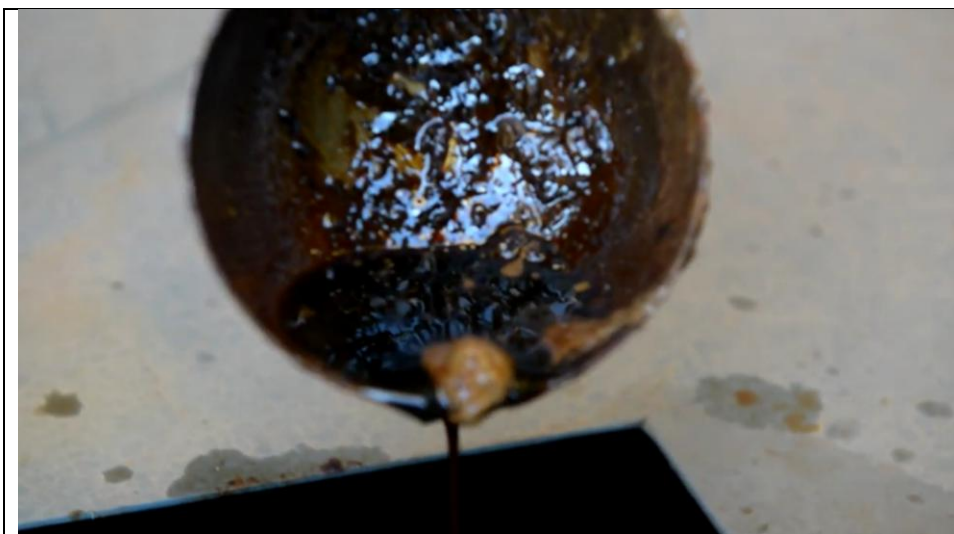

Figura 2.7- DNAPL e amostra de água

<http://en.lifediscovered.es>

Os riscos associados à presença deste tipo de poluente no subsolo são elevados. As consequências são fáceis de observar a médio e longo prazo, principalmente porque:

- a toxicidade dos poluentes no DNAPL é elevada,
- a sua solubilidade de poluentes individuais é baixa, mas frequentemente suficiente para exceder os limites permitidos na água potável, e
- têm um elevado potencial migratório, tanto através do subsolo como nas águas subterrâneas.

A infiltração destes DNAPLs através do subsolo depende da natureza da descarga, das características do líquido, tais como densidade, tensão interfacial, viscosidade e porosidade. Além disso, as forças hidráulicas impactam a infiltração. A migração do DNAPL ocorre preferencialmente através das vias mais permeáveis, tais como fracturas num ambiente rochoso ou argiloso consolidado ou camadas altamente permeáveis.

A detecção de DNAPLs em amostras de solo e águas subterrâneas é difícil, devido à cor (por vezes DNAPL é transparente), a baixas concentrações ou ao seu aspeto heterogéneo no subsolo. Todos estes factores complicam a caracterização da fonte de contaminação, situação normalmente agravada pela presença de misturas dos compostos.

Os DNAPL estão classificados em quatro grandes grupos:

- compostos orgânicos halogenados.
- alcatrão e creosotes
- bifenilos policlorados (PCBs)
- misturas e pesticidas.

A maioria dos locais afectados por DNAPL contém compostos orgânicos halogenados, principalmente organoclorados. A sua utilização generalizada, propriedades químicas e elevada toxicidade são os principais factores que acentuam o problema.

As propriedades químicas mais características do DNAPL são:

- alta densidade;
- baixa viscosidade;
- alta volatilização;
- solubilidade significativa em relação à toxicidade.

2.2.1 Volatilidade

Os DNAPL também podem ser classificados com base na volatilidade. Os compostos orgânicos voláteis são denominados de VOC (Volatile Organic Compounds). São compostos orgânicos que têm altas constantes de Henry e pressões de vapor, solubilidade moderada e baixo peso molecular.

A volatilidade de um composto é geralmente menor a temperaturas de ebulição mais elevadas (T_b), constante de Henry mais elevada (K_H) e pressão de vapor mais elevada (P_{vap}). Portanto, os VOC têm uma composição química favorável à evaporação em condições ambientais normais em relação à temperatura e pressão. Em geral, estes compostos têm uma constante de Henry superior a 10^{-5} atm m³/mol e pressões de vapor superiores a 1 mm Hg (0,0013 atm).

Relativamente à volatilidade, os compostos orgânicos podem ser classificados da seguinte forma:

- voláteis (VOC);
- semivoláteis (SVOC);
- de baixa volatilidade.

Em geral, os compostos orgânicos halogenados são voláteis ou semi-voláteis, os PCB e os pesticidas são semi-voláteis, e os óleos lubrificantes são pouco voláteis.

Compostos orgânicos	Temperatura de ebulição	Exemplo
volátil (VOC) T_b	$T_b < 250$ °C	Compostos orgânicos halogenados, PCE e TCE
semi-volátil (SVOC)	250 °C $< T_b < 390$ °C	PCB, pesticidas, pesticidas organoclorados, e outros compostos halogenados.
Pouco volátil	$T_b > 390$ °C	Óleos lubrificantes

Tabela 2.1- Volatilidade da principal classe de contaminantes

2.3 Oxidação de poluentes

A oxidação química *in situ* (ISCO) baseia-se numa reação de oxidação-redução no solo entre o oxidante injetado e os contaminantes presentes. O oxidante e quaisquer substâncias auxiliares necessárias são injetadas no solo, onde reagem com os contaminantes presentes. Como resultado, o oxidante é reduzido e os contaminantes são oxidados e decompostos em produtos inofensivos que estão naturalmente presentes no solo. Esta técnica de remediação só é adequada para a remediação da contaminação orgânica.

2.3.1 Agente oxidante

Existem várias formas diferentes de oxidantes que têm sido utilizadas para a ISCO; contudo, os quatro agentes oxidantes utilizados mais frequentemente são:

- permanganate de potássio (e.g., KMnO_4);
- peróxido de hidrogénio (H_2O_2) e ferro (Fe) (conduzida por Fenton, ou oxidação derivada de H_2O_2);
- ozono (O_3);
- persulfato de potássio ou persulfato de sódio (e.g., $\text{K}_2\text{S}_2\text{O}_8$ or $\text{Na}_2\text{S}_2\text{O}_8$).

Oxidant	Reactive Species	Form	Persistence ⁽¹⁾	Stage of Development
Permanganate	MnO_4^-	powder/liquid	>3 months	developing
Fenton's	$\cdot\text{OH}, \cdot\text{O}_2^-, \cdot\text{HO}_2, \text{HO}_2^-$	liquid	minutes - hours	experimental/emerging
Ozone	$\text{O}_3, \cdot\text{OH}$	gas	minutes - hours	experimental/emerging
Persulfate	$\cdot\text{SO}_4^{2-}$	powder/liquid	hours - weeks	experimental/emerging

Oxidant and Reactions	Electrode Potential (E_h) ⁽²⁾
Permanganate	
$\text{MnO}_4^- + 4 \text{H}^+ + 3 \text{e}^- \longrightarrow \text{MnO}_2 + 2 \text{H}_2\text{O}$	1.7 V (permanganate ion) (1)
Fenton's (H_2O_2 Derived Reactants)	
$\text{H}_2\text{O}_2 + 2 \text{H}^+ + 2 \text{e}^- \longrightarrow 2 \text{H}_2\text{O}$	1.8 V (hydrogen peroxide) (2)
$2 \cdot\text{OH} + 2 \text{H}^+ + 2 \text{e}^- \longrightarrow 2 \text{H}_2\text{O}$	2.8 V (hydroxyl radical) (3)
$\cdot\text{HO}_2 + 2 \text{H}^+ + 2 \text{e}^- \longrightarrow 2 \text{H}_2\text{O}$	1.7 V (perhydroxyl radical) (4)
$\cdot\text{O}_2^- + 4 \text{H}^+ + 3 \text{e}^- \longrightarrow 2 \text{H}_2\text{O}$	-2.4 V (superoxide radical) (5)
$\text{HO}_2^- + \text{H}_2\text{O} + 2 \text{e}^- \longrightarrow 3 \text{OH}^-$	-0.88 V (hydroperoxide anion) (6)
Ozone	
$\text{O}_3 + 2 \text{H}^+ + 2 \text{e}^- \longrightarrow \text{O}_2 + \text{H}_2\text{O}$	2.1 V (ozone) (7)
$2 \text{O}_3 + 3 \text{H}_2\text{O}_2 \longrightarrow 4 \text{O}_2 + 2 \cdot\text{OH} + 2 \text{H}_2\text{O}$	2.8 V (hydroxyl radical, see rxn 3) (8)
Persulfate	
$\text{S}_2\text{O}_8^{2-} + 2 \text{e}^- \longrightarrow 2 \text{SO}_4^{2-}$	2.1 V (persulfate) (9)
$\cdot\text{SO}_4^- + \text{e}^- \longrightarrow \text{SO}_4^{2-}$	2.6 V (sulfate radical) (10)

¹ Persistence of the oxidant varies depending on site-specific conditions. Durations specified here are based on general observations.
² Reactive species in parentheses; reduction potential is negative.

Tabela 2.2- Forma oxidante, estabilidade, fase de desenvolvimento e potencial de oxidação para oxidantes utilizados para oxidação química *in situ*

2.3.1.1 Permanganato de potássio (KMnO₄)

O permanganato persiste por longos períodos de tempo, sendo possível a difusão em materiais de baixa permeabilidade e maiores distâncias de transporte através de meios porosos.

A reação direta é a semi-reação de 3 elétrons para oxidação de permanganato (MnO₄⁻) sob a maioria das condições ambientais (pH 3,5 a 12). Um dos subprodutos da reação é o MnO₂ que na gama de pH de 3,5 a 12 é um precipitado sólido.



Figura 2.8- Exemplo de perfil de difusão do agente oxidante em núcleos de solo lodoso 90 dias após a colocação de permanganato de potássio (foto cortesia de URS, arquivo Bures)

Em condições ácidas (pH <3,5), o elemento manganês (Mn) em solução ou em forma coloidal pode estar presente em diferentes estados de oxidação [Mn(II), (IV), (VII)] dependentes do potencial óxido-redutor do meio.



Além disso, em condições fortemente alcalinas, pH>12, o Mn pode estar presente como Mn(VI).

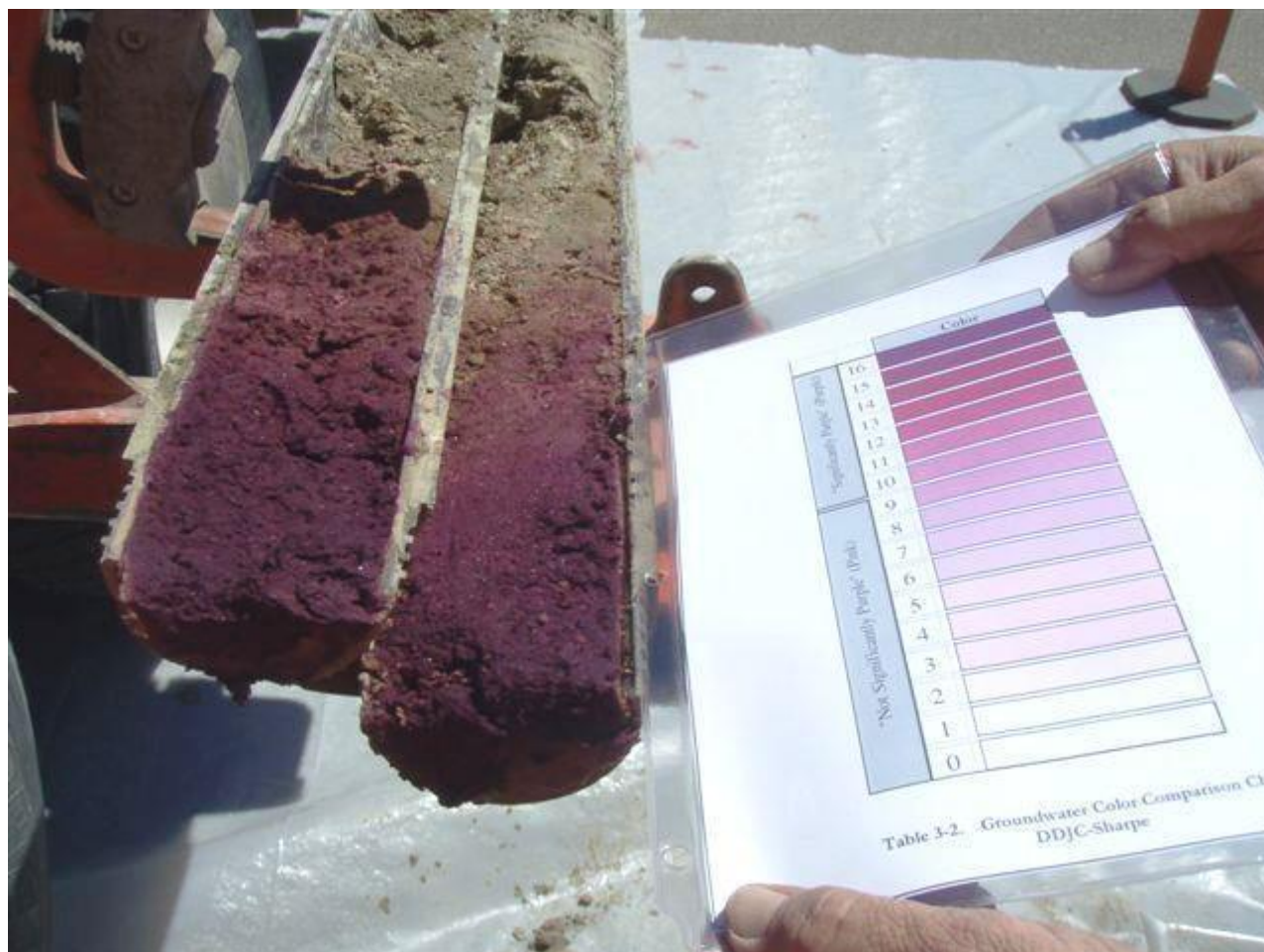
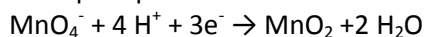
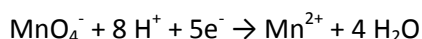
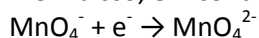

Reações de oxidação química de poluentes: percloroetileno (PCE), tricloroetileno (TCE), dicloroetileno (DCE), e cloreto de vinilo (VC), respectivamente.

- Percloroetileno (PCE)
 $4\text{KMnO}_4 + 3\text{C}_2\text{Cl}_4 + 8\text{H}_2\text{O} \rightarrow 6\text{CO}_2 + 4\text{MnO}_2 + 4\text{KOH} + 12\text{HCl}$
- Tricloroetileno (TCE)
 $2\text{KMnO}_4 + \text{C}_2\text{HCl}_3 \rightarrow 2\text{CO}_2 + 2\text{MnO}_2 + 2\text{KCl} + \text{HCl}$
- Dicloroetileno (DCE)
 $8\text{KMnO}_4 + 3\text{C}_2\text{H}_2\text{Cl}_2 \rightarrow 6\text{CO}_2 + 8\text{MnO}_2 + 2\text{KOH} + 6\text{KCl} + 2\text{H}_2\text{O}$
- Cloreto de vinilo (VC)
 $10\text{KMnO}_4 + 3\text{C}_2\text{H}_3\text{Cl} \rightarrow 6\text{CO}_2 + 10\text{MnO}_2 + 7\text{KOH} + 6\text{KCl} + \text{H}_2\text{O}$

O dióxido de carbono (CO_2) é um subproduto da oxidação e mineralização de produtos químicos orgânicos e matéria orgânica natural. Em estudos de coluna, a redução da permeabilidade e da eficiência de lavagem diminuiu como resultado da precipitação de $\text{MnO}_2(\text{s})$ e da formação de $\text{CO}_2(\text{g})$.

2.3.1.2 Peróxido de hidrogénio (H_2O_2)

A clássica reação de Fenton envolve especificamente a reação entre H_2O_2 e ferro ferroso [$\text{Fe}(\text{II})$] produzindo o radical hidroxilo ($\cdot\text{OH}$) e íons férrico [$\text{Fe}(\text{III})$] e anião hidróxido (OH^-).

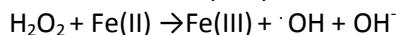

$\text{Fe}(\text{III})$ reage com H_2O_2 ou o radical superóxido ($\cdot\text{O}_2^-$)



$\text{Fe}(\text{III})$ reage com o radical superóxido ($\cdot\text{O}_2^-$)

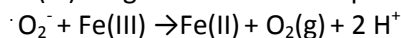

Esta sequência geral de reações continua a ocorrer até que o H_2O_2 seja totalmente consumido. Uma vez que o H_2O_2 injetado no subsolo reage com muitas outras espécies químicas além do $\text{Fe}(\text{II})$, esta tecnologia é frequentemente referida como peróxido de hidrogénio catalítica (CHP).

Está relatado que o H_2O_2 persiste no material do solo e do aquífero entre minutos a horas, e as distâncias de transporte difuso e advectivo serão relativamente limitadas. Os intermediários dos radicais formados utilizando alguns oxidantes (H_2O_2 , $\text{S}_2\text{O}_8^{2-}$, O_3), que são largamente responsáveis por várias transformações de contaminantes, reagem muito rapidamente e persistem por períodos de tempo muito curtos (<1 seg).

2.3.1.3 Ozono (O_3)

A oxidação de O_3 *in situ* envolve a injeção de uma mistura de ar e gás O_3 diretamente para as zonas insaturadas e/ou saturadas. A tecnologia de aspersão de ar é uma tecnologia que foi rigorosamente investigada e partilha muitas semelhanças com a aspersão de O_3 , fornecendo uma visão dos mecanismos de transporte e transferência de massa com aspersão de O_3 *in situ*, que não foi rigorosamente investigada em sistemas de subsuperfície. A injeção de ar sob o lençol freático promove a volatilização, fornece oxigénio para a degradação aeróbica, e pode induzir a mistura da água subterrânea (Johnson, 1998).



Figura 2.9- Modelo concetual geral de ozonização *in situ* na zona saturada com extração de vácuo do solo para captar emissões voláteis e O₃.

2.3.1.4 Persulfato de sódio ou de sódio

O Persulfato é o oxidante mais forte da família do peróxigênio, com um potencial de oxidação de 2,12 volts. Conforme ilustrado abaixo, a reação de oxidação direta de meia célula para o persulfato envolve uma transferência de dois electrões:

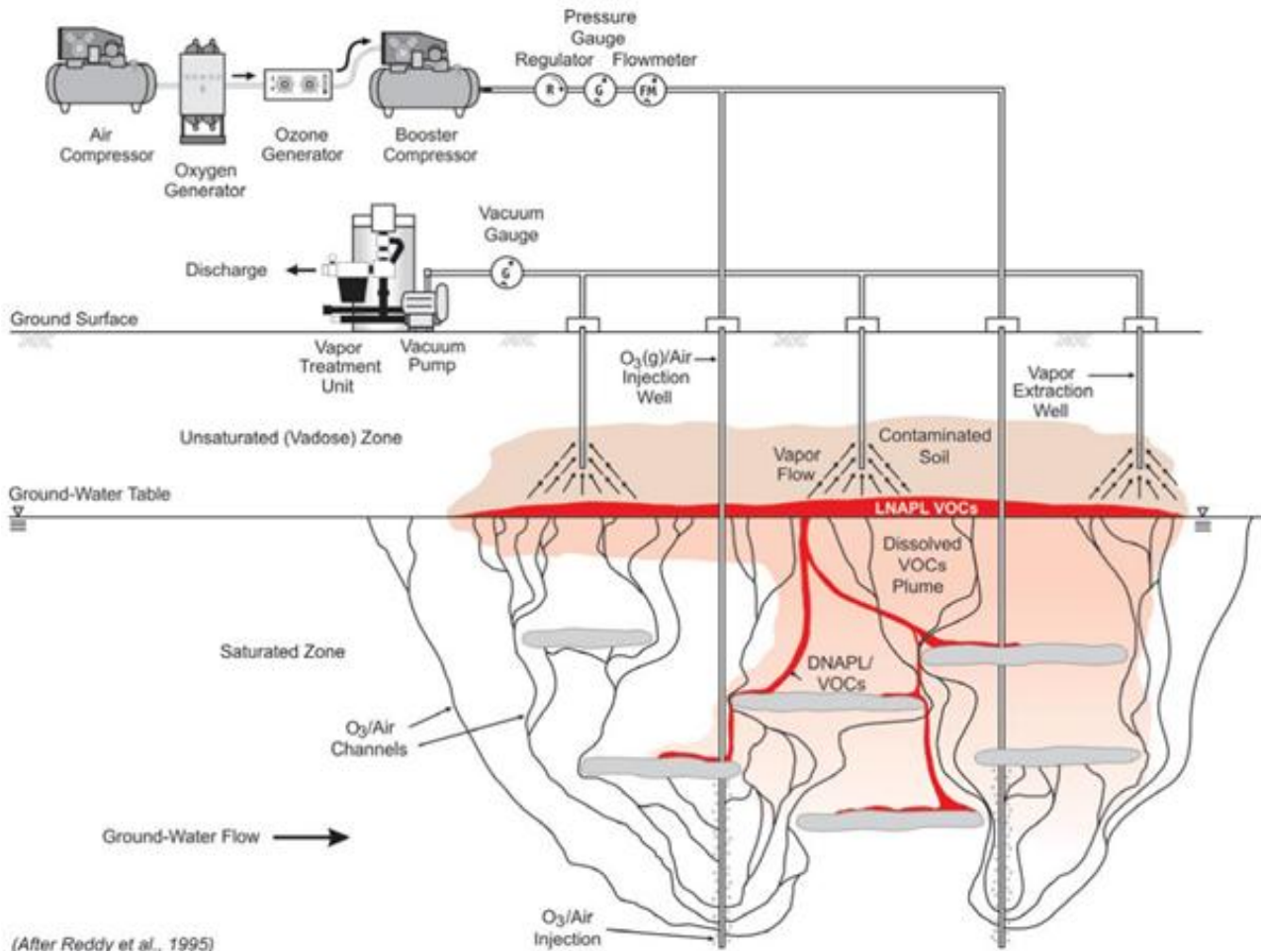
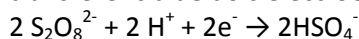

Contudo, na maioria dos casos, a rápida destruição do poluente exige que o persulfato seja ativado a fim de gerar radicais sulfato (SO₄·). Os radicais sulfato são poderosos agentes oxidantes, com um potencial de oxidação de 2,6 volts.

- Persulfato de sódio:
 - Ativado em condições alcalinas
 - Ativado com peróxido de hidrogénio

O persulfato activado é catalisado com peróxido e a base fornecida pelo peróxido de cálcio:



O persulfato activado pode permanecer disponível no subsolo durante meses, proporcionando uma combinação de potência e estabilidade.

A adição de peróxido de cálcio proporciona vários benefícios. Em primeiro lugar, confere a alcalinidade e o peróxido necessários para activar o persulfato utilizando a química de activação. Segundo, quando misturado com água, fornece uma fonte de libertação lenta e a longo prazo de peróxido de hidrogénio e hidróxido de cálcio.

O peróxido de hidrogénio que se forma lentamente decompõe-se em oxigénio e água, fornecendo uma fonte alargada de oxigénio para posterior bioremediação de hidrocarbonetos petrolíferos. A abordagem utilizada para ativar o radical sulfato foi a utilização de um pH elevado, utilizando peróxido de cálcio.

A energia de ativação do persulfato é fornecida pelo peróxido de cálcio, que também tem a função de regular a alcalinidade (restaurando um ambiente básico) e libertar lentamente o peróxido de hidrogénio e o hidróxido de cálcio, com formação de peróxido de hidrogénio. O peróxido de hidrogénio decompõe-se em oxigénio e água, desempenhando o papel de uma fonte de oxigénio necessária para a decomposição dos hidrocarbonetos.

2.4 A ISCO em contexto

ISCO ID País, organização e localização	Oxidante	Poluentes	Área m ²	Observações
Israel. Ludan environmental technologies	KMnO ₄	Solventes clorados, principalmente tricloroetileno (TCE). Outros: Manganês, Crómio	300	
Alemanha. RiskCom GmbH	KMnO ₄ Na ₂ S ₂ O ₈ Aditivos: Goma Guar	PCE/TCE de até 200 000 µg/L Concentrações de VOC no solo > 6000 mg/kg Concentrações de amostras de águas subterrâneas até 447000 µg/L VOC totais.	1000 (estimado)	ISCO utilizando o fraturamento hidráulico (injetado sob pressão) como método de colocação preferencial.
Alemanha. SENSATEC GMBH. Local perto de Frankfurt am Main, Alemanha, nos terrenos de uma antiga instalação de fabrico de produtos químicos que produzia solventes para o trabalho de metais, produtos químicos de limpeza e óleos especiais.	Persulfato de potássio ativado por ativação alcalina através da adição de peróxido de cálcio, viscosificante de polímero orgânico	TPH e BTEX na zona insaturada com concentrações de contaminantes superiores a 5000 mg/kg e 344 mg/kg, respectivamente. Águas subterrâneas com concentrações até 44300 µg/L (CHCs), seguidas de TPH (2.000 µg/L) e BTEX (1.800 µg/L).	620	Colocação de oxidantes por fraturamento de solo TSE

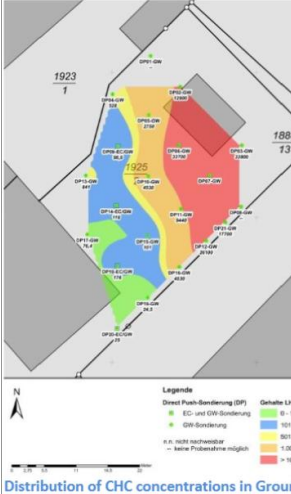
				
<p>Áustria. Keller Grundbau Ges.mbH. O local está localizado no coração de Graz, Estíria</p>	<p>$KMnO_4$</p>	<p>Tetracloroetileno foi utilizado em lavanderia química no local. As concentrações mais elevadas de 14000 mg/m^3 encontradas abaixo do local de instalação das máquinas de lavar roupa.</p>	<p>300 (estimado)</p>	
<p>Países Baixos. Heijmans Infra BV Perto do centro da cidade de Uden, Holanda.</p>	<p>Persulfato de Sódio (Klozur R One). Assumiu-se que a carência de Persulfato de Sódio era de $3,0 \text{ g}$ de Persulfato/kg de solo</p>	<p>Hidrocarbonetos clorados Solventes clorados, especialmente tricloroetileno. $> 16000 \text{ } \mu\text{g/l}$ na zona saturada. Na zona insaturada estava presente mais de 16000 mg/kg de tricloroetileno.</p>	<p>270</p>	
<p>Itália. REGENESIS. Região do Veneto, Itália Um caminhão-cisterna de combustível capotou numa pequena estrada no norte de Itália, derramando mais de 36.000L de gasóleo e gasolina. O combustível teve impacto num canal, defesas contra inundações, solos e águas subterrâneas na vizinhança próxima.</p>	<p>Percarbonato de sódio e líquido/gel composto principalmente por silicato de ferro</p>	<p>Solo impactado com TPH e BTEX Águas subterrâneas impactadas com MTBE e TPH</p>	<p>Cerca de 500</p>	

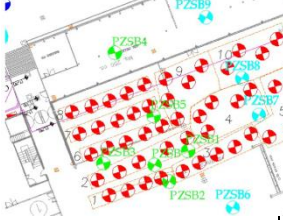
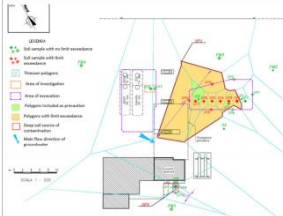
<p>Itália. ARPA Campania. A empresa opera e produz nos sectores da defesa, aeroespacial e de segurança.</p> <p>Perto do Lago Fusaro confirmar zona https://www.leonardocompany.com/</p>	<p>Permanganato de Sódio Solução de permanganato de sódio com uma concentração de 40%</p>	<p>Solos: Hidrocarbonetos: 3500 mg/Kg</p> <p>Águas subterrâneas Benzo(a)antraceno: 7.6 µg/L Pireno: 29 µg/L Benzo(b)fluoranteno: 4.2 µg/L Benzo(g,h,i)perileno: 2.2 µg/L Hidrocarbonetos policíclicos aromáticos (soma): 10 µg/L Tetracloroetileno: 50 µg/L Tricloroetileno: 5.4 µg/L Cloreto de vinilo: 4.1 µg/L Benzeno: 27 µg/L Xileno: 133 µg/L Tolueno: 22 µg/L</p>	<p>300 (calculado)</p>	
<p>Itália. Golder Associates S.r.l. Estação de serviço de petróleo, com armazenamento de combustível em tanques subterrâneos, localizada no centro de Itália.</p>	<p>Persulfato de sódio (Na₂S₂O₈), ativado adicionando o hidróxido de sódio (NaOH)</p> <p>Peróxido de cálcio (CaO₂), para melhorar a biorremediação.</p>	<p>Solo profundo não saturado com benzeno 163 mg/kg SS etilbenzeno 502 mg/kg SS tolueno 648 mg/kg SS xileno 1,472 mg/kg SS hidrocarbonetos leves C≤12 19,509 mg/kg SS hidrocarbonetos pesados C>12 5.742 mg/kg SS MtBE 736 mg/kg SS</p> <p>- Águas subterrâneas, com benzeno 46 µg/l tolueno 3.800 µg/l p-xylene 2.619 µg/l hidrocarbonetos totais (como n-hexano) 13.000 µg/l MtBE 230 µg/l</p>	<p>800 (calculado)</p>	
<p>Itália. Stantec Um local de venda de combustíveis até 2015,</p>	<p>Persulfato e peróxido de cálcio</p>	<p>A contaminação por MTBE foi detetada antes da demolição da fábrica.</p>	<p>1500</p>	

desde 2015 que tem sido uma área de estacionamento. Foi colocada a hipótese de uma fuga de petróleo dos tanques e/ou das linhas durante as atividades de venda.				
França. ARTELIA Antiga estação de serviço que tinha sido desmantelada e está em processo de cessação de atividades Impacto do solo e das águas subterrâneas devido a um incidente - libertação de hidrocarbonetos	Permanganato de sódio a 20%.	Concentrações no solo: TPH C5-C10: 250 até 1 500 mg/kg BTEX: 80 até 820 mg/kg Concentrações máximas nas águas subterrâneas: TPH C5-C10: 52 000 até 48 500 ug/l BTEX: 43 000 até 96 980 ug/l		
Itália. Arcadis Italia s.r.l. Estação de combustível expropriada localizada numa zona plana do norte de Itália. A atividade do local consistia na distribuição de produtos petrolíferos para transporte com armazenamento temporário das substâncias dentro de tanques subterrâneos.	Persulfato (solução aquosa a 20%) e um activador (peróxido de cálcio) que aumentam o pH.	As amostras de águas subterrâneas indicaram a presença de Benzeno (10 µg/L), Hidrocarbonetos totais (1000 µg/L) e EtBE (1000 µg/L) Solo, presença em solo saturado de EtBE (0,5 mg/Kg).	450	
Itália. Mares S.r.l. Localizado na margem sul do Lago Maggiore, numa zona subplana. Uma estação de serviço, onde foram realizadas a comercialização de produtos petrolíferos para veículos automóveis, o reabastecimento de veículos automóveis, venda de lubrificantes e troca de óleo de automóveis.	Complexo oxidante à base de persulfato de sódio ativado com peróxido de cálcio.	TPH e BTEX Amostras de águas subterrâneas mostraram a presença de MTBE	200 (estimado)	
Alemanha. Züblin Umwelttechnik GmbH Local industrial, apresentou	NaMnO ₄ solução 40%.	As águas subterrâneas mostraram um CVOC máximo claro com	Toda a zona de contaminaç	

<p>contaminação maciça das águas subterrâneas no gesso Keuper.</p>		<p>concentrações de 30 a 50 mg/l</p>	<p>ã 20.000 m², Fonte de contaminação 5.000 m²</p>	 <p><small>Fig. 3. Contaminant distribution based on groundwater modelling before the start of remediation work in 2005</small></p>
--	--	--------------------------------------	--	--

3 ESTUDO DE VIABILIDADE

Como a ISCO é uma tecnologia de remediação muito versátil, a aplicação deve ser adaptada a cada local específico. Projetar uma remediação sustentável significa também que os aspetos ambientais, sociais e económicos devem ser combinados para alcançar a melhor solução possível para o local. Assim, é crucial comparar as soluções mais viáveis e identificar a mais sustentável.

Para adquirir as informações necessárias, devem ser executados os seguintes passos:

- definição dos objetivos da ISCO no projeto de remediação;
- aplicabilidade do tratamento ISCO por:
 - triagem inicial;
 - análise detalhada.

3.1 Definição de objetivos

O primeiro passo para verificar a viabilidade do tratamento com oxidantes químicos consiste em definir os objetivos do projeto global de remediação. A definição do objetivo deve descrever os níveis de concentração a atingir e qualquer fator limitante, incluindo os recursos económicos e o prazo.

O objetivo da remediação com oxidantes pode ser definido em termos de valores de rastreio (objetivos de remediação, por exemplo, MCLs), ou um nível de concentração intermédio, identificado como parte de uma abordagem integrada de remediação, baseada em diferentes mecanismos de ação (físicos, químicos e biológicos). Por exemplo, a fim de maximizar a eficiência da remediação, a ISCO pode ser aplicada após tratamento com agentes tensoativos ou dessorventes químicos, ou utilizada como primeiro passo para reduzir a concentração de contaminantes e torná-los compatíveis com a ativação de uma biorremediação.

São exemplos de objetivos para a ISCO:

- reduzir a massa de contaminante na zona de tratamento (por exemplo, em 90%);
- atingir um nível de contaminação especificado (objetivo de remediação) para o tratamento pós-ISCO;
- atingir um nível de contaminação especificado (alvo de remediação) em um ou mais pontos de conformidade relevantes.

3.2 Aplicabilidade da ISCO

O diagrama de blocos na Figura 3.1 é útil como rastreio inicial, quando a decisão de proceder a uma remediação ISCO tem de ser tomada.



Figura 3.1- Rastreo inicial da potencial eficácia da ISCO, da EPA dos EUA (2004)

Um primeiro rastreio para avaliar a viabilidade do tratamento ISCO inclui:

- carência de oxidantes;
- características hidrogeológicas e lito-estratigráficas;
- presença de infra-estruturas subterrâneas.

3.2.1 Carência de oxidantes

A presença de NAPLs na fase móvel causa uma carência excessiva de oxidantes e isto pode comprometer a viabilidade devido ao aumento da quantidade de oxidantes e ao número de injeções necessárias que se transformam em análises de custo desfavoráveis, como é mostrado no diagrama da Figura 3.2.



Figura 3.2- Impacto das fases de contaminação, transferência de massa e limitações de transporte de massa na massa de oxidante e/ou no número de aplicações de oxidante necessárias para a ISCO

A Tabela 3.1 analisa possíveis situações e descreve diferentes estratégias na aplicação de uma ISCO eficiente: no caso das primeira e segunda opções do quadro (NAPL móvel; pools NAPL contínuos) deve ser utilizada em primeiro lugar outra tecnologia.

Nature of contaminant	ISCO Applicable?	Considerations
Mobile NAPL: Continuous NAPL pools	Possible, but challenging	Co-solvent/surfactant or very high oxidant dose required
Residual NAPL: Discontinuous NAPL globules	Yes, but challenging	Co-solvent/surfactant or high oxidant dose
High groundwater concentrations: >10 mg/L	Yes, a good fit	Standard
Low groundwater concentrations: <1 mg/L	Yes, but may not be cost effective	Cost driven by matrix oxidant demand and size of plume

Tabela 3.1: Aplicabilidade geral da ISCO (ITRC, 2005)

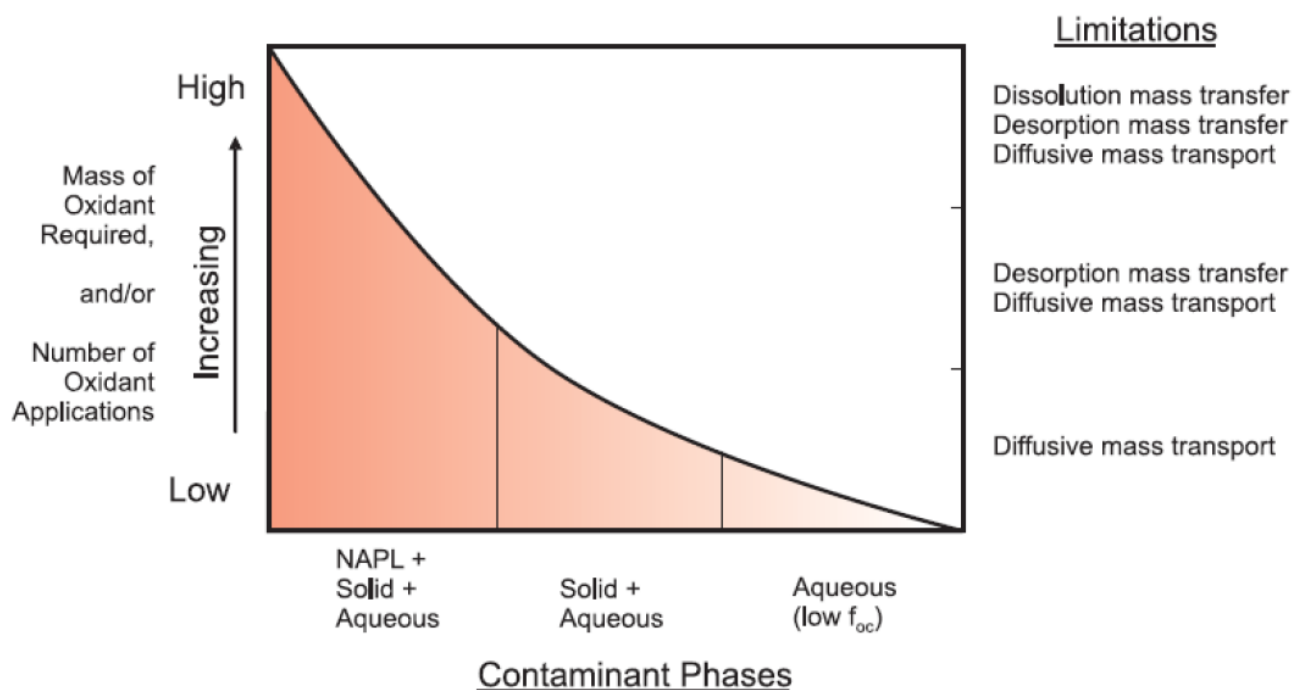
Os testes realizados utilizando KMnO_4 como oxidante, mostram que as condições ideais de aplicação da ISCO são satisfeitas a valores de SOD/TOD (carência de oxidante do solo/ carência total de oxidante) inferiores a 30 g/Kg de solo seco. Os esquemas dos Quadros 3.2 e 3.3 relacionam a aplicabilidade da ISCO com a carência de oxidante do solo e a carência total de oxidante em g/Kg de solo seco, incluindo o poluente, e a fração de carbono orgânico do solo.

SOD/TOD (g/Kg solo seco)	Aplicabilidade da ISCO
<30	aplicável
>30	a considerar

Tabela 3.2: Relação entre o oxidante a aplicar no solo, o rácio de carência total de oxidante e a aplicabilidade da ISCO

foc (%)	Aplicabilidade da ISCO
<0,3	aplicável
0,3<foc<3	a considerar
>3	não recomendado

Tabela 3.3: Relação entre a fração de carbono orgânico do solo e a aplicabilidade da ISCO

3.2.2 Características lito-estratigráficas e hidrogeológicas do sítio

A permeabilidade e a correspondente taxa de fluxo de águas subterrâneas afetam a distribuição do oxidante no aquífero e, portanto, o sucesso da ISCO (ver Tabela 3.4). A alta permeabilidade significa geralmente um transporte elevado de oxidante. Uma baixa permeabilidade reduz o Raio de Influência (ROI), ou seja, a área afetada pelos oxidantes; neste caso, a grelha de injeção tem de ser espessada ou são necessárias pressões de injeção elevadas, utilizando a hidrofratura, por exemplo, na presença de aditivos adequados.

Permeabilidade (m/s)	Aplicabilidade da ISCO
>10-4 m/s	excelente
10-5 ⇔ 10-4 m/s	aplicável
<10-5 m/s	não recomendado

Tabela 3.4: Aplicabilidade da ISCO em função da permeabilidade

Contudo, se a velocidade for demasiado elevada, é necessário avaliar se o tempo de contacto entre o oxidante e o poluente é suficiente para que a reacção de oxidação aconteça e realize o tratamento.

O sucesso da ISCO depende também da profundidade do lençol freático (ver Quadro 3.5). O intervalo ideal para a aplicação da ISCO na zona saturada é entre 3 m e 15 m de profundidade. Com uma profundidade inferior a 3 m, é possível o afloramento do lençol freático; a aplicação em profundidades de aquífero superiores a 15 m, necessita de considerações económicas adicionais.

Profundidade do lençol freático (m)	Aplicabilidade da ISCO
<3	a avaliar
3 ÷ 15	excelente
>15	a considerar

Tabela 3.5: Aplicabilidade da ISCO em função da profundidade do lençol freático

espessura da camada do subsolo (m)	Aplicabilidade da ISCO
<15	aplicável
>15	a considerar

Tabela 3.6: Aplicabilidade da ISCO em função da espessura da camada de subsolo

A aplicação de ISCO na zona vadosa apresenta dificuldades relacionadas com a propagação de produtos oxidantes e a sua reatividade com o solo.

3.2.3 Presença de infra-estruturas

A aplicação de tratamentos *in situ* pode ser limitada pela presença de infra-estruturas enterradas e/ou utilidades subterrâneas; estas podem ser danificadas por atividades de injeção devido tanto à reatividade dos produtos como aos elevados volumes e pressões necessários para dispersar os reagentes.

As estruturas enterradas podem também afectar a eficácia da injeção devido à presença de potenciais vias preferenciais que poderiam desviar o reagente e invalidar o tratamento. A presença de barreiras enterradas pode também limitar a eficácia da intervenção porque pode atrasar ou impedir o contacto com os contaminantes alvo.

Durante o estudo de viabilidade é necessário realizar investigações (geofísicas, geoelétricas) que forneçam informações sobre a presença de infra-estruturas como apoio à conceção executiva da intervenção.

3.3 Segundo rastreio

Nesta fase, à medida que são verificadas as condições descritas na primeira fase de rastreio, é necessário um segundo rastreio mais detalhado. A influência de outros fatores tais como: pH, alcalinidade e salinidade (concentração de cloreto) deve ser avaliada. As variações dos valores de pH podem afectar o transporte de metais e iões em solução que podem reagir com os radicais produzidos pelo sistema oxidante, diminuindo potencialmente a sua eficácia contra os contaminantes.

Salinidade (Cloreto mg/L)	Aplicabilidade da ISCO
<1000	aplicável
>1000	a avaliar

Tabela 3.7: Aplicabilidade da ISCO em função da salinidade

Alcalinidade (mg/L como CaCO ₃)	Aplicabilidade da ISCO
<1000	aplicável
>1000	a avaliar

Tabela 3.8: Aplicabilidade da ISCO em função da alcalinidade

Factor	Detail to consider
Oxidant type	<ul style="list-style-type: none"> • Amenability of primary contaminants of concern (COCs) to oxidation • Amenability of co-contaminants to oxidation • Overall Oxidant Amenability • Ability of approach to work with site fraction organic carbon (FOC) • Ability of approach to work with site pH • Ability of approach to work with site alkalinity • Ability of approach to work with site chloride • Ability of approach to work with site COC mass distribution
Implementation (injection) methods	<ul style="list-style-type: none"> • Amenability to site media type • Amenability of delivery technique to site hydraulic conductivity • Amenability to site heterogeneity • Ability to reach depth of contamination • Ability to treat contaminant density • Disruption of site surface activities • Disruption of subsurface activities
The oxidants and activators considered	<ul style="list-style-type: none"> • Permanganate • Ozone (including ozone only, and ozone activated with peroxide) • Hydrogen peroxide (including Iron/acid activation, chelated iron activation, no activation (mineral catalysis)) • Percarbonate • Persulphate (including alkaline activation, thermal activation, iron / acid activation, chelated activation, peroxide activation, no activation (mineral catalysis))

Factor	Detail to consider
The injection methods considered	<ul style="list-style-type: none"> • Direct-push probe injection • Vertical injection wells • Horizontal wells • Vertical wells – recirculation • Soil mixing • Hydraulic fracture emplaced ISCO amendment • Pneumatic fracture emplaced ISCO amendment • Trench or curtain injection • Surface application / infiltration gallery

Tabela 3.9- Fatores e detalhes a considerar

3.4 Tratabilidade dos contaminantes

Os contaminantes são de diferentes classes químicas de substâncias, cada uma com as suas próprias propriedades, pelo que mostram diferentes possibilidades de tratamento de oxidação. A Tabela 3.10 mostra o potencial de oxidação de diferentes contaminantes.

Altamente oxidável	Potencialmente oxidável
cloroetano	cloroetano
clorobenzeno	clorometano e bromometano
BTEX	explosivos
hidrocarbonetos policíclicos aromáticos (HPAs)	pesticidas
fenóis	N-Nitrosodimetilamina (NDMA)
MTBE	cetonas
álcool	PCB
1-4 dioxano	dioxinas-furanos

Tabela 3.10: O potencial de oxidação para diferentes contaminantes

4 TESTE DE CAMPO/EM LABORATÓRIO

O passo consequente após o estudo de viabilidade, caso a ISCO tenha sido identificada como parte de um projeto global de remediação, é o planeamento do tratamento ISCO. Como descrito no capítulo introdutório, durante a fase de planeamento, serão necessárias atividades que incluam um estudo aprofundado do Modelo Concetual do Local (RDC) e, quando necessário, testes de laboratório ou de campo à escala piloto.

4.1 Aspetos de concepção

Os principais aspectos a serem avaliados na concepção do tratamento ISCO são:

- a escolha do tipo de oxidante;
- a quantidade de oxidante;
- a escolha do sistema de injeção.

4.1.1 Escolha do tipo de oxidante

Os seguintes aspectos são tidos em conta na escolha de oxidantes compatíveis com contaminantes: cinética da reacção, densidade do oxidante, geologia, hidrogeologia, concentração de contaminantes e carência de oxigénio nas águas subterrâneas/de um aquífero geralmente referido como carência oxidante natural (NOD). A adequação dos agentes oxidantes em função destes factores é descrita nas secções seguintes.

4.1.1.1 Cinética da reacção

Descreve a destruição de um contaminante ao longo do tempo. Se a concentração do oxidante for muito superior à concentração do composto a ser oxidado, a reacção segue uma cinética de primeira ordem. Como consequência, a taxa de reacção pode ser medida por meio de uma duração média (média do tempo de vida).

O tempo de semi-vida é o tempo necessário de uma reacção para reduzir a metade a concentração de contaminantes. A duração da semi-vida depende do tipo de oxidante utilizado e das combinações de contaminantes presentes no subsolo. A oxidação química só é viável no caso da taxa de oxidação do contaminante ser superior à taxa de interação entre o oxidante e a carência de oxidante do aquífero.

A cinética da reacção é também influenciada por processos de dispersão, dessorção, dissolução e difusão que afetam tanto o transporte dos agentes oxidantes como o transporte dos contaminantes através do subsolo.

Os oxidantes químicos são insolúveis em líquidos em fase não aquosa (NAPLs), enquanto a oxidação dos contaminantes ocorre apenas em fases aquosas. Portanto, a transferência de massa dos contaminantes para a fase aquosa tem de ocorrer primeiro, seguida do processo de oxidação. A taxa de remoção da massa contaminante está estritamente relacionada com a dissolução das NAPL, um processo lento em comparação com a oxidação. Para uma distribuição mais uniforme do oxidante, sugere-se uma densidade do oxidante o mais próxima possível da densidade do contaminante, a fim de promover as mesmas vias de difusão para ambos os compostos.

4.1.1.2 Geologia e hidrogeologia

O transporte do agente oxidante na zona saturada deve-se principalmente ao fluxo de águas subterrâneas, à lei de Darcy, e à dispersão. A dispersão desempenha um papel fundamental no caso de fluxo fraco das águas subterrâneas ou na distribuição de produtos particularmente concentrados.

Podemos distinguir entre três tipos de litologias: baixa, moderada e alta permeabilidade. Na Tabela 4.1, a adequação dos oxidantes é dada em função da categoria de permeabilidade.

Litologia	Permanganato de potássio /sódio	Peróxido de hidrogénio	Percarbonato de sódio	Persulfato de Sódio	Ozono
Altamente permeável	+++	+++	+++	+++	+++
Baixa permeabilidade	+		-/+	+	Sem dados
Moderadamente permeável	++		+	++	Sem dados

Tabela 4.1 – Escolha do oxidante em função da categoria de permeabilidade

-/+ questionável, + adequado, ++ muito adequado, +++ altamente recomendado

4.1.1.3 Carência de oxigénio nas águas subterrâneas e no aquífero (NOD)

A distância de transporte do oxigénio ao longo das partes não contaminadas do aquífero depende não só da carência total de oxigénio, mas também das seguintes variáveis:

- taxa de reação com substâncias não alvo;
- caudal das águas subterrâneas;
- densidade da solução.



Figura 4.1 – Taxa de reação oxidante/densidade da solução, em função da taxa de fluxo das águas subterrâneas

4.1.1.4 pH

A ISCO pode ter um impacto considerável no pH do solo, quer porque o oxidante pode ser associado à possível produção de prótons ou diretamente à produção de íões hidróxido durante a reacção. A extensão do efeito do pH depende da capacidade tampão do solo e, conseqüentemente, da concentração de carbonatos. A concentração de carbonatos influencia, portanto, a cinética da reacção. Na Tabela 4.2 a adequação dos oxidantes é dada em função do pH do subsolo.

pH	Permanganato de potássio /sódio	Peróxido de hidrogénio	Percarbonato de sódio	Persulfato de Sódio	Ozono
<5	+++	+++	--	+++	+++
5-6	+++	+++	+	+++	+++
6-7	+++	++	++	+++	+++
7-8	+++	+	+++	+++	++
8-9	+++	-	+++	+++	++
>9	++	--	+++	+++	+

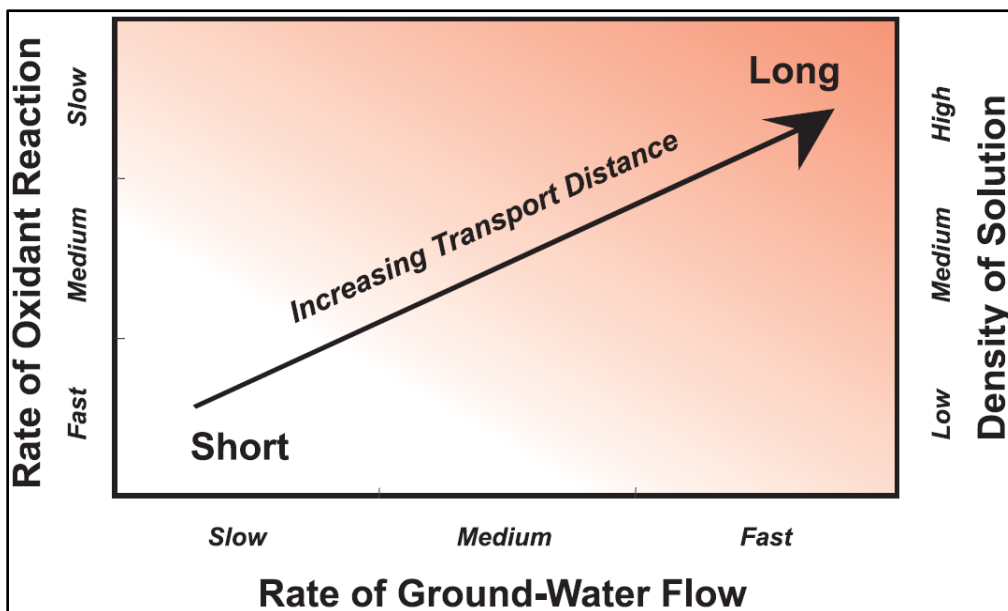
Tabela 4.2 escolha de oxidante/pH

-- certamente não adequado, - não adequado, + adequado, ++ muito adequado, +++ altamente recomendado

4.1.1.5 Fração de matéria orgânica (f_{oc})

Ao escolher o tipo de oxidante, é importante avaliar a reatividade do produto com substâncias orgânicas não alvo (matéria orgânica no subsolo), a fim de aumentar a SOD. Na Tabela 4.3, a adequação dos oxidantes é dada em função da fração de carbono orgânico no subsolo.

f_{oc}	Permanganato de potássio /sódio	Peróxido de hidrogénio	Percarbonato de sódio	Persulfato de Sódio	Ozono
>3%	--	--	-	+	--
1-3%	-	-	+	++	-
0,3-1%	++	++	+++	+++	++
0,1-0,3%	+++	+++	+++	+++	+++
<0,1%	+++	+++	+++	+++	+++

Tabela 4.3 - Escolha de oxidante em função do teor de carbono orgânico do subsolo (f_{oc})

-- certamente não adequado, - não adequado, + adequado, ++ muito adequado, +++ altamente recomendado

4.1.1.6 Concentração de contaminantes

A concentração de contaminantes é também um aspeto a ser considerado na escolha do agente oxidante. É necessário utilizar oxidantes altamente reativos na área da fonte de contaminação, enquanto que nas áreas da pluma de contaminação, sugere-se a escolha de reagentes menos reativos, a fim de maximizar a gama de influência. A adequação dos oxidantes é dada em função da concentração de contaminantes na Tabela 4.4.

Concentração de contaminantes	Permanganato de potássio /sódio	Peróxido de hidrogénio	Percarbonato de sódio	Persulfato de Sódio	Ozono
muito baixa					+
baixa	++	++	++	++	++
moderada	+++	+++	+++	+++	+++
alta	++	+++	++	+++	+
muito alta		++	+	++	-

Tabela 4.4 – Adequação dos oxidantes em função da categoria de concentração de contaminantes

- não adequado, + adequado, ++ muito adequado, +++ altamente recomendado

4.1.1.7 Compatibilidade ambiental dos oxidantes

Cinética de reacção, concentração do oxidante, pH e temperatura do aquífero, concentração de contaminantes e carência de oxigénio no solo (SOD) fazem parte do conjunto de variáveis que determinam a "longevidade" do oxidante; ou seja, a persistência do oxidante quando aplicado no substrato a ser tratado. Este aspeto é de importância fundamental uma vez que afecta o raio de influência (ROI) que o oxidante pode atingir, enquanto está ativo.

Como mencionado no capítulo introdutório, a ISCO é uma abordagem que raramente pode ser implementada por si só como uma tecnologia de remediação, especialmente no caso de limites regulamentares rigorosos. Frequentemente, é necessária uma remediação combinada. Isto implica uma etapa subsequente que poderia ser uma biorremediação melhorada ou acelerada.

Uma abordagem verde e eficaz para o tratamento destes constituintes é a utilização de um agente passivo com libertação controlada para estimular a biodegradação *in situ*. A biorremediação é eficiente na mineralização dos intermediários formados durante a oxidação, que de outra forma permaneceriam como recalcitrantes. A biorremediação pode ser a fase final rentável na consecução do objetivo global de um projeto de restauro das águas subterrâneas.

Na seleção dos oxidantes, é, portanto, necessário considerar cuidadosamente os agentes oxidantes que não são agressivos para os microorganismos do subsolo.

Em casos específicos, é necessário verificar se os subprodutos da reacção não pioram as condições hidroquímicas das águas subterrâneas, especialmente se estiver presente algum recetor sensível e/ou se o recurso hídrico subterrâneo tiver utilizações especiais. Exemplos de subprodutos gerados ou substâncias mobilizadas pela reacção de oxidação são: sulfatos, manganês, cromo e outros metais pesados.

A presença de estruturas subterrâneas, condutas ou sistemas de esgotos pode constituir uma limitação importante durante a seleção do agente oxidante. Não é recomendada a injeção de grandes volumes de produto perto das fundações. A mesma conclusão vale para a utilização de oxidantes que requerem um pH baixo na proximidade de tanques subterrâneos, condutas ou infraestruturas delicadas.

4.1.2 Quantidade de oxidante

Para determinar a quantidade de reagente necessária para uma oxidação química no local, é necessário identificar a carência total de oxigênio (TOD) necessária para o tratamento específico do local. A TOD inclui a carência de oxigênio para oxidar os contaminantes alvo e o oxigênio requerido pelas substâncias "não alvo", contidas no subsolo, que são recetoras de electrões (NOD/SOD).

4.1.2.1 Contaminantes de interesse

A carência de oxidantes relacionada com os contaminantes que suscitam preocupação deve ser avaliada em todas as fases possíveis:

- fase dissolvida;
- fase de sorção;
- fase livre;
- Líquidos de fase não aquosa (NAPL);
- Fase de vapor (zona vadosa).

A fim de determinar a carência de oxigênio necessária, deve primeiro ser avaliada a massa total de cada tipo de contaminante presente no subsolo. Subsequentemente, a largura, comprimento e profundidade da área da fonte de contaminação deve ser estimada. Finalmente, dependendo do tipo de solo (cascalho, areia, limo ou argila), deve ser feita uma avaliação quantitativa do volume, densidade e volume de poros do solo contaminado.

O valor da massa da fase dissolvida pode ser calculado através da análise das concentrações de contaminantes presentes nos poços de monitorização. A carência de oxigênio relacionada com a fase absorvida, por outro lado, pode ser estimada directamente a partir da análise de amostras de solo recolhidas *in situ* ou indirectamente através de cálculos estequiométricos a partir da massa de contaminante. Isto depende da densidade do material do aquífero, da fração de carbono orgânico (foc) e do coeficiente de distribuição (carbono orgânico - água nos poros) do contaminante (Koc). A densidade do solo e os valores da foc podem ser estimados de acordo com o tipo de solo, enquanto o valor de Koc pode ser derivado da literatura ou de bases de dados *online*.

A apreciação da massa de NAPL da fase livre é normalmente complexa. A este respeito, vários métodos de cálculo foram desenvolvidos pela API e pela EPA dos EUA.

4.1.2.2 Matriz

Os reagentes injetados no subsolo também reagirão obviamente com substâncias orgânicas e inorgânicas naturalmente presentes no subsolo. Uma vez que em certos casos a quantidade de oxigênio necessária pode ser significativa, deve ser dada especial atenção ao requisito básico de oxidantes baseados em reações catalíticas ou para os quais são utilizados outros reagentes como estabilizadores ou catalisadores. Um exemplo deste tipo de sistema é o peróxido de hidrogênio catalítico por ISCO.

O peróxido de hidrogénio irá formar rapidamente complexos de superfície e reagir com metais de transição como o ferro em superfícies minerais. Um outro fator a considerar nos processos a longo prazo é o potencial dos processos de transporte, tal como mencionado na secção 4.1.1, para transportar componentes reativos adicionais para a zona de tratamento.

4.1.2.3 Determinação da carência de oxidante

Há duas abordagens para calcular a carência de oxidante:

- através de um sistema baseado no Carbono Orgânico Total (TOC) e na Carência Química de Oxigénio (COD);
- através da fração molar.

A quantidade de oxidante utilizada para a reação deve ser superior à carência teórica de oxidante, a fim de assegurar uma quantidade suficiente de reagente para manter a cinética de primeira ordem.

4.1.3 Entrada do agente oxidante

Os principais aspetos a considerar na conceção da injeção de reagentes são:

- A heterogeneidade lito-estratigráfica que condiciona a escolha da tecnologia de injeção e da disposição. O método de pressão direta permite uma maior versatilidade na distribuição do reagente, ajustando os intervalos verticais e horizontais da injeção com base nas diferentes permeabilidades das camadas a tratar. Isto evita que o reagente seja distribuído principalmente nas camadas mais transmissivas; uma situação que enfatiza o fenómeno de retorno de contaminante. A resolução espacial horizontal e vertical do valor ROI deve ser planeada com atividades de Caracterização do Desenho de Remediação, dependendo da heterogeneidade lito-estratigráfica do local.
- Resultados de injeções de teste durante os testes à escala piloto. Recomenda-se a realização de testes de injeção como parte da implementação à escala piloto, a fim de obter informações sobre os valores da pressão de injeção e volumes de reagentes aplicáveis para cada camada homogénea.
- Resultados de estudos de marcadores (por exemplo, lítio e fluoresceína) que podem ser utilizados para apoiar atividades à escala piloto.

4.1.4 Volumes de reagente a injetar

Para realizar um tratamento eficaz, deve ser injetada uma quantidade suficiente de oxidante no espaço poroso do solo para garantir a cinética de primeira ordem da reação.

O volume de reagente a injetar é calculado com base na porosidade efetiva do volume do solo a tratar. Na presença de geologia heterogénea, é aconselhável estimar os valores efetivos da porosidade para cada camada separadamente, de preferência com base na análise granulométrica através de sedimentação.

É necessário injetar um volume equivalente a 10% a 50% da porosidade efetiva. A percentagem de espaço vazio que deve ser tratado diretamente pela injeção depende do ROI concebido, pois espera-se que a porção restante dos microporos seja atingida pelo reagente através da advecção.

Um estudo de implementação à escala piloto permite a aquisição de informação detalhada sobre a cinética das reações que regem a transferência de massa de oxidante por advecção e dessorção. Isto permite a estimativa do número de injeções necessárias, o intervalo de tempo entre injeções e a dosagem ótima de oxidante de cada injeção.

4.1.5 Acessibilidade da área de intervenção

- Quando a operação de tratamento envolve áreas com atividades em curso ou acesso público (por exemplo, estradas, áreas escolares, etc.), os custos associados ao isolamento temporário dessas áreas devem também ser considerados.
- Neste caso, é necessário avaliar se o número de injeções necessárias torna a instalação de poços de injeção fixos (poços de válvulas) economicamente benéfica.

4.1.6 Tecnologias de injeção

As tecnologias mais utilizadas para a injeção do reagente no aquífero são as seguintes:

- Injeção de Tecnologia Direct-Push (pressão direta) - As injeções de reagente no aquífero são efetuadas por meio de hastes ocas de aço ranhuradas e utilizando bombas de pistão especiais que permitem atingir pressões elevadas (> 50 bar);
- Poços valvulados - São pontos fixos de injeção constituídos por um tubo de PVC, instalados por perfuração de núcleo contínuo e selagem da cavidade com betão. O tubo está equipado com grupos de 4 furos no mesmo plano, a uma distância de 30-50 cm. As válvulas são cobertas com uma manga elástica atuando como uma válvula anti-retorno.
- Piezómetros existentes - As injeções são feitas utilizando a seção de filtro dos piezómetros, selados com dois bicos.

Cada tecnologia tem vantagens e desvantagens. O método de "direct-push" permite a variação da posição dos pontos de injeção para cada campanha. Isto torna possível reforçar grandemente a grelha de injeção e consequentemente garantir uma maior probabilidade de contacto com o contaminante a ser tratado.

Um espaçamento mais fino também permite baixar a pressão de injeção, com um menor risco de fratura da matriz e consequente heterogeneidade no tratamento e a possibilidade de o produto subir ao longo da haste de injeção. O limite técnico da tecnologia, em termos de profundidade de injeção, é de 30-35 metros.

A utilização da tecnologia de "direct-push" torna-se não lucrativa quando são necessárias mais de 5-6 campanhas de injeção.

A tecnologia que fornece pontos de injeção fixos (poços valvulados) tem as seguintes vantagens:

- profundidade de injeção até 100 m;
- pressões de injeção elevadas, até 90 bar;
- possibilidade de utilizar misturas muito viscosas;
- maior controlo do intervalo de injeção vertical;
- custo-eficácia do tratamento, caso seja necessário um elevado número de injeções (> 5-6);
- menor impacto para tratamentos, em áreas com atividades em curso.

A utilização dos piezómetros existentes tem a vantagem económica de reutilizar o material já presente na área de tratamento. Na maioria dos casos, contudo, não permite uma distribuição homogénea na área de tratamento, uma vez que os piezómetros foram concebidos para diferentes fins. O tratamento com piezómetros existentes ainda pode ser incluído num projeto que integra as diferentes tecnologias de injeção, para maximizar a eficiência global da intervenção.

As imagens seguintes mostram os métodos de injeção com poços valvulados e "direct-push".



Figura 4.2- Poços valvados e tecnologias de injeção por pressão direta (<https://www.carsico.it/servizi/>)

Diversos tipos de estratégias de injeção são descritos nos números seguintes.

	<p>Grelha É o método mais versátil para assegurar uma distribuição homogênea do produto na área de interesse.</p>
--	---

	<p>Injetar e derivar/infiltração</p> <p>Este sistema aproveita o fluxo de água subterrânea para espalhar o produto de subgradiente através de advecção. Esta abordagem pode ser utilizada em áreas onde a velocidade do fluxo é elevada e a litologia é relativamente homogênea.</p> <p>O agente oxidante é aplicado no solo através de sondas de infiltração, sem o auxílio de ações mecânicas ou pressões. Com um sistema passivo é necessário ter em conta a capacidade de infiltração do solo, a profundidade do lençol freático, a taxa de fluxo das águas subterrâneas e a vida útil do oxidante. A capacidade de infiltração do solo está fortemente relacionada com o tipo de solo. Ao desenvolver o esquema de infiltração, é importante estimar a capacidade de infiltração com a maior precisão possível.</p> <p>Os valores apresentados no quadro abaixo são uma estimativa aproximada da capacidade de infiltração. Os testes de infiltração no solo podem ajudar a determinar uma estimativa mais precisa da capacidade de infiltração do solo. Não há razão para testar a capacidade de infiltração de solos que já têm uma baixa permeabilidade.</p> <p>A utilização de um método de aplicação indireta requer um caudal de águas subterrâneas superior a 0,05 m/dia. Se o fluxo de águas subterrâneas for inferior a 0,05 m/dia, a aplicação de infiltração passiva é complexa, uma vez que o oxidante será insuficientemente distribuído.</p> <p>A infiltração é uma técnica de injeção válida apenas se forem cumpridas as seguintes condições:</p> <ul style="list-style-type: none"> ● O oxidante deve permanecer reativo no subsolo o tempo suficiente para oxidar os contaminantes. ● Regra de ouro: <ul style="list-style-type: none"> ○ a semi-vida do oxidante no meio é superior ao dobro do tempo de reação ○ o oxidante deve permanecer estável no solo o tempo suficiente para alcançar um grande raio de influência.
	<p>Recirculação</p> <p>Esta estratégia consiste na injeção do oxidante num ponto e a extração simultânea das águas subterrâneas noutro ponto.</p> <p>A utilização desta estratégia é tipicamente limitada a locais com uma transmissividade relativamente elevada.</p> <p>O método é uma combinação de Bombear e Tratar com ISCO.</p> <p>Este processo tem a vantagem de criar um elevado gradiente hidráulico dentro da área contaminada e, conseqüentemente, uma maior área de influência.</p>

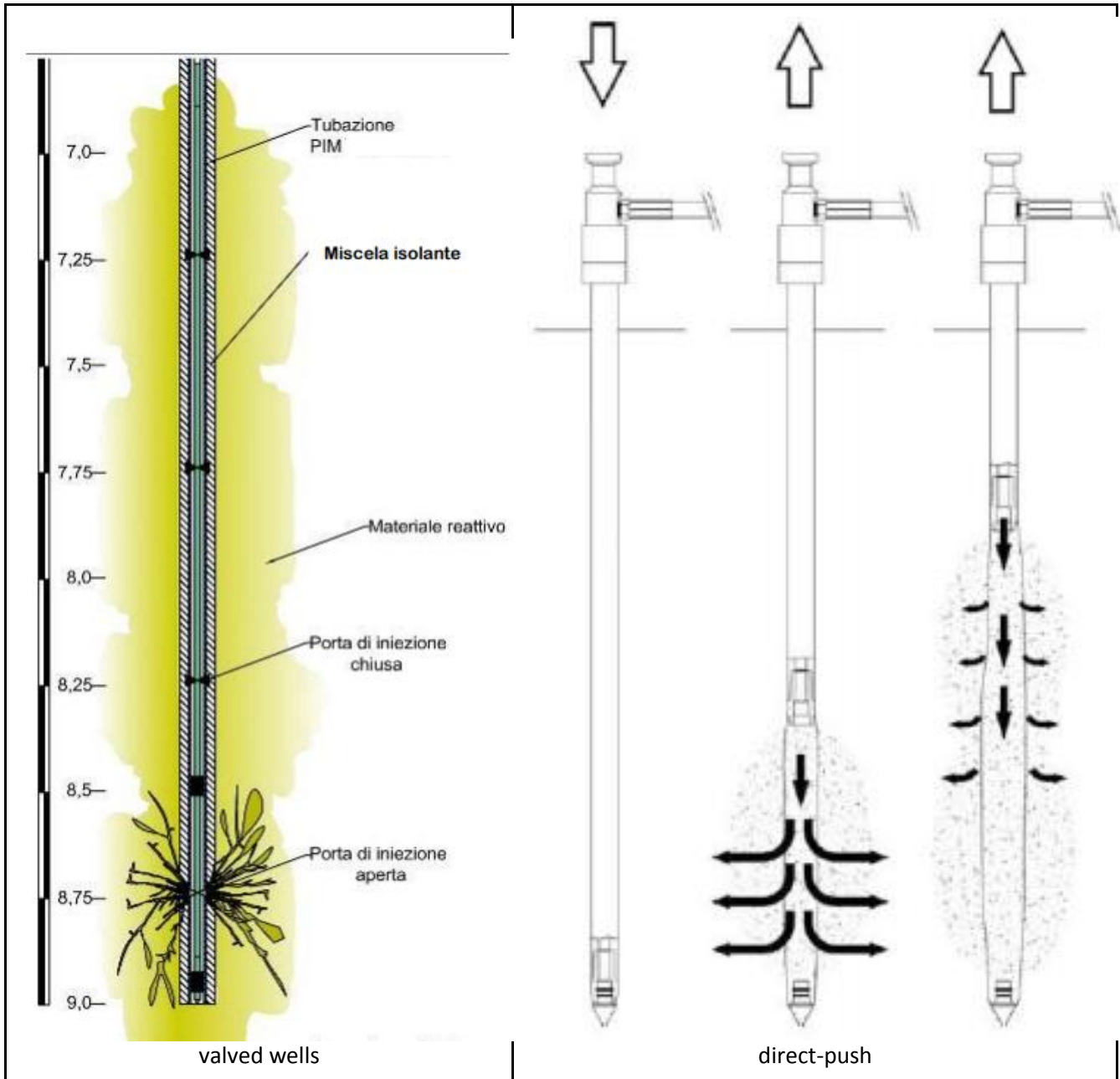
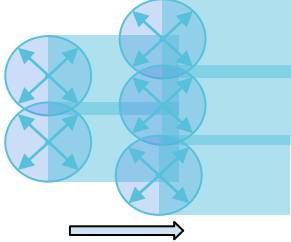
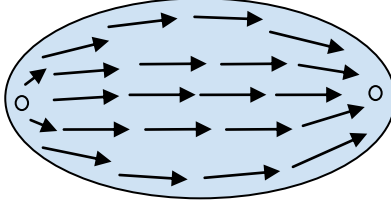
	<p>Barreira</p> <p>Esta estratégia consiste na distribuição do oxidante em uma ou mais passagens lineares de modo a que as águas subterrâneas contaminadas fluam passivamente para a área de tratamento. Tais estratégias utilizam uma barreira contra a migração de contaminantes, mas não para o fluxo de águas subterrâneas. As estratégias de barreira são aplicáveis aos sistemas de distribuição contínua (p. ex., a formação de ozono).</p>
	<p>Mistura do solo</p> <p>O solo é misturado com o reagente por meio de uma broca. O método só é viável para tratamentos a uma profundidade de alguns metros.</p>

Figura 4.3- Tipos de estratégias de injeção

parâmetro	filtros	“direct push”	recirculação	infiltração	mistura do solo
$> 10^{-5}$ m/seg	+++	+++	+++	+++	+++
$10^{-6} \div 10^{-3}$ m/seg	++	+++	+	++	+++
$10^{-7} \div 10^{-8}$ m/seg	-	-	--	-	+++
$< 10^{-8}$ m/seg	--	--	--	--	+++

Tabela 4.5- Aplicabilidade das tecnologias de injeção em função da condutividade hidráulica

-- = certamente não adequado, - não adequado, + adequado, ++ muito adequado, +++ altamente recomendado

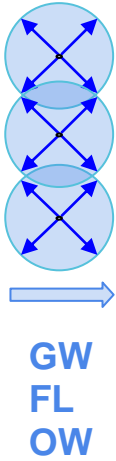
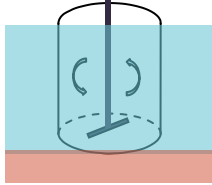
parametro	filtros	“direct push”	recirculação	infiltração	mistura do solo
< 5 m bgl	+++	+++	+++	+++	+++
5 ÷ 10 m bgl	+++	+++	+++	-	+++
10 ÷ 25 m bgl	+++	++	+++	--	-
25 ÷ 50 m bgl	++	+	++	--	--
> 50 m bgl	++	--	++	--	--

Tabela 4.5- Aplicabilidade das tecnologias de injeção em função da profundidade da zona de tratamento

-- = certamente não adequado, - não adequado, + adequado, ++ muito adequado, +++ altamente recomendado

Em Dal Santo e Prosperi (2020), os prós e contras de cada método de aplicação são listados, ver Quadro 4.6.

MÉTODO	APLICABILIDADE	PROS	CONS
“Direct push” (Pressão direta)	Para a aplicação de todos os tipos de produtos	Boa distribuição no aquífero, se concebida com uma malha adequada. Não afeta a funcionalidade dos poços da rede de monitorização	Pontos não-repetíveis. É necessário um sistema de sonda geológica para repetir a injeção. Durante a aplicação num aquífero fino, a elevação do reagente no espaço anular pode ser registada em alguns casos
Tubos de válvula	Para a aplicação de todos os tipos de produtos	Boa distribuição no aquífero, se concebida com uma malha adequada. Quando necessário, um novo ciclo de injeção pode ser feito utilizando os mesmos tubos de válvula dos pontos repetíveis. Não afeta a funcionalidade dos poços da rede de monitorização. A aplicação é também eficiente em aquíferos finos sem elevação de reagentes à superfície. A injeção é completamente controlada utilizando embaladores para conduzir o reagente através das válvulas.	Custo adicional para a instalação da rede de injeção com tubos de válvulas

<p>Piezómetros existentes</p>	<p>Para a aplicação de todos os tipos de produtos</p>	<p>Sem custos adicionais para a construção de pontos de injeção</p>	<p>A localização e o intervalo de rastreio dos poços já estão definidos.</p> <p>A injeção pode afetar a funcionalidade da rede de monitorização com oclusões parciais e formação de subprodutos dentro da coluna do poço</p> <p>A injeção não é completamente controlada utilizando o crivo dos poços para a distribuição do reagente e não dos tubos de válvula</p>
--------------------------------------	---	---	--

Tabela 4.6- Os prós e os contras de cada método de aplicação (retirado de Dal Santo e Prosperi, 2020)

4.2 Testes laboratoriais e testes-piloto

A decisão de utilizar testes à escala laboratorial e/ou à escala piloto deve ser avaliada de acordo com a complexidade e a dimensão do local.

O investimento em custos de aquisição de informação deve ser contrabalançado pela diminuição das incertezas que poderiam causar o fracasso na realização dos objetivos do tratamento ISCO. O processo de aquisição de informação com atividades laboratoriais ou à escala piloto é iterativo e desenvolve-se com base na necessidade de maximizar a eficácia e eficiência da intervenção global.

4.2.1 Ensaio de bancada

As informações a serem obtidas dos testes à escala laboratorial são:

- informação sobre a cinética da reação, formação de produtos intermédios (incluindo gases), e o calor produzido;
- carência de oxigénio dos contaminantes dissolvidos ou saturados no solo;
- a carência de oxigénio na matriz solo;
- potencial de mobilização de metais;
- capacidade tampão do solo;
- efeitos potenciais sobre a permeabilidade (por exemplo, formação de MnO_2);
- substâncias oxidantes que tornam a reação de oxidação mais eficiente;
- informação para calcular o Raio de Influência (ROI).

Os testes laboratoriais não são geralmente representativos das condições de campo, devido a problemas de escala e heterogeneidade das condições hidrogeológicas, cinética de reacção, e outras características físicas ou químicas que não podem ser avaliadas no laboratório. Apesar destas limitações, os resultados dos testes laboratoriais podem fornecer uma avaliação inicial, a nível de rastreio, da potencial eficácia do reagente/produto comercial sobre os contaminantes dentro da área a ser tratada. Os conhecimentos adquiridos podem ser utilizados para conceber e implementar um teste piloto. Os testes laboratoriais devem ser concebidos para satisfazer objectivos pré-determinados e necessidades específicas para a concepção.

4.2.2 Teste piloto

Os testes-piloto são intervenções de tratamento em pequena escala, com o mesmo esquema de concepção previsto para o tratamento de toda a área.

O conjunto de atividades a realizar como parte do teste piloto visa reduzir a incerteza associada à presença de numerosas variáveis relacionadas com a heterogeneidade do local, a presença de restrições estruturais e o desempenho esperado em termos de redução da contaminação. Os objetivos do teste piloto são, portanto, a avaliação da:

- viabilidade técnica da ISCO;
- compatibilidade com limites orçamentais (como parte de uma intervenção global de remediação);
- dados de concepção da intervenção, em termos de processo e desempenho.

A área de ensaio deve ser identificada tendo em conta os objetivos do tratamento oxidante. A utilização mais eficiente da oxidação química ocorre onde a concentração de contaminantes alvo é mais elevada, ou seja, nas áreas da fonte de contaminação. Quando a estratégia de intervenção também inclui "tratamento de pluma", é necessário planear as injeções de reagentes, a fim de evitar tanto o risco de não distinguir os fenómenos normais de "retorno de contaminante" como a entrada de contaminação em áreas acima do gradiente.

As informações a recolher durante a fase piloto devem verificar a eficácia em termos de viabilidade, eficiência, processo e desempenho do projeto de remediação. Durante a fase-piloto, poderá assim surgir a necessidade de reavaliar as fases anteriores e de adquirir mais conhecimentos em termos de caracterização.

A aquisição de informação como parte do teste piloto diz essencialmente respeito aos dados do processo (seleção do reagente oxidante e aplicação à Zona de Tratamento Alvo), e aos dados de desempenho (redução da contaminação e efeitos secundários). Com base no feedback obtido, deve ser verificada a necessidade de adquirir novas informações (caraterização do conceito de remediação) e/ou de reavaliar a viabilidade da tecnologia e/ou da abordagem de intervenção.

4.2.3 Monitorização do processo

O sucesso dos tratamentos de remediação *in situ* é fortemente condicionado pela aplicação correta do reagente nas áreas a tratar. A monitorização do processo tem o objetivo de controlar os parâmetros técnicos relacionados com as actividades de injeção, bem como as respostas da área de tratamento em termos de perturbação dos parâmetros físico-químicos esperados. Se os dados adquiridos durante e após as actividades de injeção evidenciarem situações não previstas anteriormente pelo projecto de intervenção, é necessário repetir as etapas acima descritas, para assegurar uma intervenção "à escala real" eficaz e eficiente.

4.2.4 Monitorização do desempenho

nível de água subterrânea	Aumentos inusitados do nível das águas subterrâneas tornam possível verificar a presença de quaisquer vias preferenciais para o movimento de líquidos dentro da matriz do solo.
pressão de injeção	Pressões de injeção mais elevadas do que o esperado podem ser causadas pela baixa permeabilidade do substrato a ser tratado. Um aumento da pressão para compensar a resistência da matriz pode produzir uma distribuição descontrolada de reagentes devido a fracturas. É portanto necessário adquirir mais informação. As pressões de injeção inferiores às previstas, possivelmente associadas a um aumento do fluxo, podem ser causadas pela presença de vias preferenciais (por exemplo, condutas de cabos, esgotos).
parâmetros físico-químicos	Valores inesperados de condutividade, temperatura, pH, potencial redox e oxigénio dissolvido sugerem a presença de vias preferenciais ou um ROI insuficiente.

Tabela 4.6- Resumo dos parâmetros mais essenciais do processo

4.2.4.1 Indicadores

Diferentes tipos de indicadores de desempenho podem ser identificados para medir a diminuição progressiva da contaminação, por exemplo

- concentração de contaminantes - indicador utilizado para comparar com os limites regulamentares (MCL), ou para avaliar a transição para outras tecnologias (por exemplo, Biorremediação, MNA). A concentração pode ser avaliada espacialmente, usando mapas de isoconcentração e temporalmente, calculando a tendência usando testes estatísticos (p.ex., Mann Kendall);
- taxa de exaustão em massa - indicador utilizado para demonstrar o grau de eficiência do tratamento. A avaliação da massa destruída pode ser obtida através do cálculo do balanço de massa total. Para realizar uma avaliação rigorosa da massa (incluindo o NAPL), o solo saturado deve também ser amostrado. Outra forma menos rigorosa, que, no entanto, subestima a massa real, é baseada na variação da massa dissolvida.
- fluxo de massa - indicador utilizado para demonstrar a retenção do contaminante dentro da área da fonte.

4.2.4.2 Monitorização da rede

Os pontos de monitorização na área testada devem ser planeados com o objetivo de medir o desempenho do tratamento e, portanto, os objetivos da intervenção da ISCO. Podem ser identificadas as seguintes áreas:

- tratamento - área afectada pelo tratamento com base no ROI de cada ponto de injeção;
- transição - área afectada pelos efeitos geoquímicos produzidos pelo reagente;
- pluma - área da pluma com contaminação residual;

- os pontos onde foram realizadas injeções só podem ser utilizados para fins de monitorização em alguns casos dado que poderiam fornecer uma informação irrealista.

Os pontos de monitorização na área da fonte são utilizados para verificar o Raio de Influência (ROI).

O número de piezómetros necessários depende dos objetivos do tratamento:

- para verificar a redução da massa na área da fonte, os piezómetros na área tratada são suficientes;
- para avaliar a conformidade com os limites regulamentares (MCL), é necessário fornecer pontos na área da pluma;
- para avaliar a persistência dos efeitos secundários em termos de efeitos sobre a concentração de subprodutos nas águas subterrâneas devido ao tratamento (por exemplo sulfatos, Mn) e/ou mobilização de poluentes (por exemplo metais pesados), é necessário fornecer pontos de controlo nas áreas de transição geoquímica.



Figura 4.4: Posição dos poços de monitorização

4.2.4.3 Frequência

A frequência de monitorização deve permitir uma visão da evolução dos efeitos do tratamento. Nas fases iniciais do tratamento, a frequência deve ser muito elevada; enquanto que nos períodos subsequentes pode ser reduzida com base na avaliação dos dados recolhidos.

Os aspectos típicos a serem monitorizados com o objectivo de avaliar o desempenho do tratamento são:

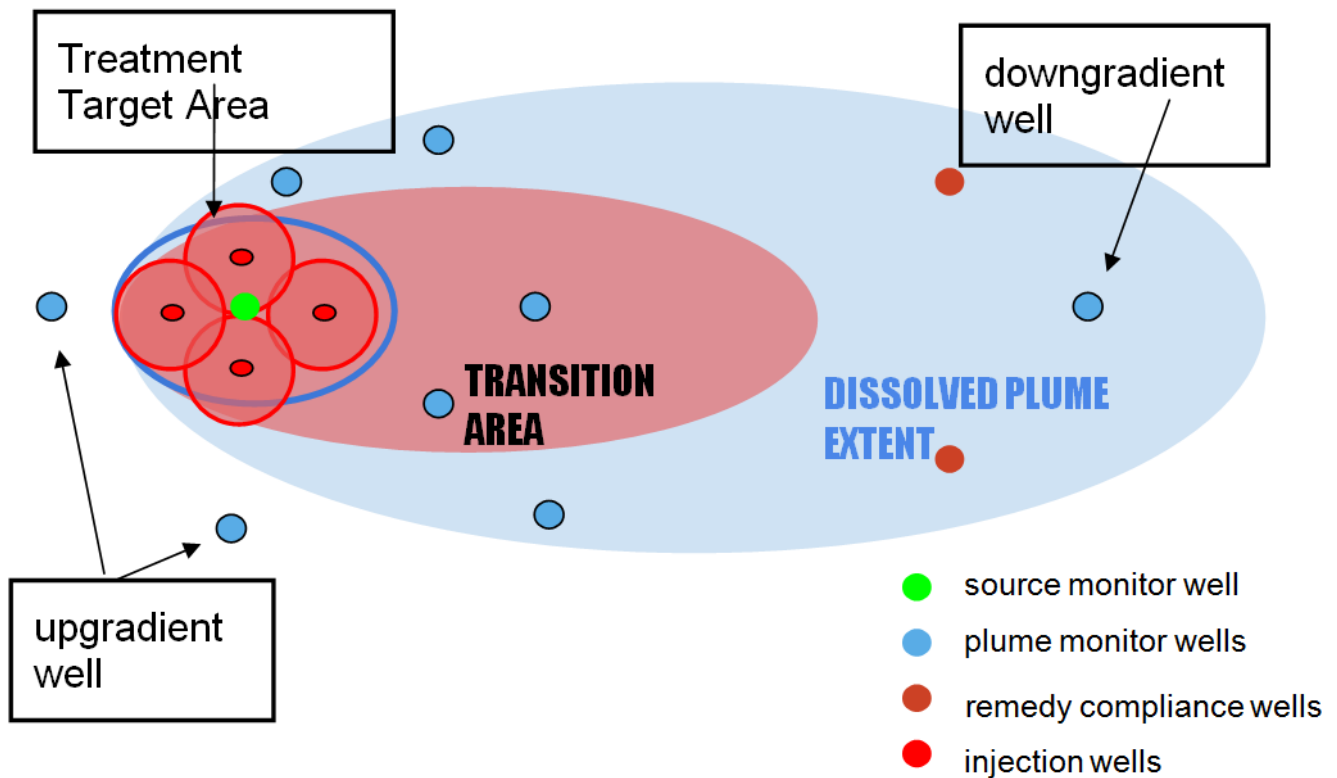
- parâmetros que permitem verificar a longevidade do reagente, por exemplo, pH, potencial redox (ORP), oxigénio dissolvido (DO);
- fenómeno de "retorno de contaminante" - ligado aos mecanismos de transferência de fase (dessorção e dissolução) do contaminante;
- semi-vida da concentração do poluente - ligada à cinética de reacção.

Alguns critérios para o planeamento da frequência de monitorização são:

- a velocidade do lençol freático;
- cinética de reação do produto oxidante.

5 MONITORIZAÇÃO

5.1 Tipos de ensaios

Antes de selecionar e aplicar um agente oxidante na ISCO, é necessário conhecer em pormenor as condições hidrogeológicas do local e a geoquímica do subsolo para decidir sobre o tipo, método e quantidade do agente aplicado. Uma vez que estas condições podem ser muito diferentes, a monitorização é essencial para uma aplicação bem-sucedida da ISCO. Antes da implementação da remediação, recomenda-se, portanto, a realização de:

- Testes laboratoriais. O objetivo destes testes é avaliar a eficiência de um tipo específico de reagente numa amostra de material de solo do local e calcular o seu consumo.
- Testes de rastreio. O objetivo destes testes é excluir a existência de rotas preferenciais indesejáveis através das quais o reagente possa drenar. Por conseguinte, a direção e velocidade real do fluxo de águas subterrâneas e o transporte de contaminantes e reagentes devem ser caracterizados por estes testes. Alguns tipos de fluoresceína, LiCl, etc., podem ser utilizados para este fim. Os resultados do teste de rastreio devem fornecer os dados necessários para especificar o sistema de intensificação do procedimento de remediação, que consistirá na infiltração de reagentes ISCO no âmbito das campanhas de aplicação e, quando apropriado, a aplicação de soluções de apoio PAL (tensioativos aniónicos). Por vezes, uma direção de movimento desejada do reagente infiltrado pode ser manipulada através do bombeamento em furos seleccionados e infiltração do outro lado. Após o início do ensaio, as amostras serão colhidas num intervalo de tempo correspondente às condições hidrogeológicas, por exemplo, uma vez por dia durante 5 dias num solo arenoso, mas em período significativamente mais longo em solos com menor permeabilidade.
- Testes semi-operacionais no local. O objetivo destes testes é avaliar a ISCO durante o funcionamento. Os testes são realizados num furo seleccionado, durante cerca de um mês. Como resultado, a dosagem de agentes oxidantes, agentes tensioativos e parâmetros tais como a quantidade de agente oxidante, o método e a frequência da dosagem podem ser adaptados.

É aconselhável combinar a ISCO com outras intervenções de remediação *in situ* na zona saturada utilizando métodos de remediação hidráulica e tecnologias de apoio à lavagem com agentes tensioativos (PAL). A aplicação PAL é concebida para remover a fase livre, enquanto as aplicações ISCO estão localizadas nas partes periféricas, para remoção da contaminação dissolvida na direção do fluxo de águas subterrâneas. A infiltração pode ser realizada através de furos verticais, furos horizontais, paredes reactivas e sondas de pressão.

A seleção da localização dos poços de monitorização deve ser compatível com a posição dos poços de infiltração e dos pontos de contaminação - na entrada das águas subterrâneas para o local (poços de referência) e na saída do local (poços de monitorização), bem como objetos bombeados e poços em plumas de contaminação.

Vários métodos podem ser utilizados para equilibrar a quantidade de contaminantes no subsolo e a quantidade de contaminantes degradados:

- O equilíbrio de um contaminante degradado devido à alteração de uma quantidade total de contaminação num local. No caso de métodos de remediação *in situ*, podem ser efetuadas alterações nas concentrações de produtos em decomposição de ponta a ponta para um equilíbrio do contaminante degradado. No caso de degradação *in situ* de hidrocarbonetos clorados, o equilíbrio do contaminante degradado pode ser realizado em condições apropriadas com base nas alterações nas concentrações de cloreto. No entanto, a utilização de cloretos exclui com bastante frequência as suas elevadas concentrações laterais nas águas subterrâneas.

- O equilíbrio de um contaminante degradado com base na quantidade consumida de substâncias de apoio. O equilíbrio de um contaminante degradado com base numa alteração das concentrações de produtos de degradação.
- O equilíbrio de um contaminante degradado com base numa alteração na razão isotópica C12/13 e Cl 35/37. Esta é a mais recente e provavelmente a forma mais precisa de equilíbrio de substâncias orgânicas decompostas *in situ*. O método baseia-se na monitorização de alterações na composição isotópica de C12/13 como resultado da degradação *in situ* de uma contaminação baseada em hidrocarbonetos. Recentemente, a razão isotópica Cl35/37 também começou a ser utilizada. Esta é provavelmente a forma mais promissora de realizar o balanço *in situ* dos hidrocarbonetos orgânicos degradados.

5.2 Tipos de monitorização

5.2.1 Monitorização operacional - tecnológica

O objetivo é monitorizar a concentração do reagente, o seu movimento no subsolo e a funcionalidade dos dispositivos.

Durante a remediação, as concentrações de poluentes e reagentes são monitorizadas nos poços disponíveis e é continuamente avaliado se a remediação é efectuada correctamente. Os resultados são avaliados regularmente em relatórios anuais, com recomendações.

5.2.2 Monitorização em contínuo e na fase final

O objetivo é avaliar se os objectivos da remediação foram alcançados com sucesso.

Só é possível começar a provar o cumprimento dos parâmetros alvo de remediação no momento do desaparecimento da substância de apoio (reagente) e os efeitos decorrentes da sua presença no subsolo (reagente que não responde/não reagiu).

Existem várias abordagens que podem ser utilizadas para avaliar a evolução dos parâmetros alvo da remediação:

- O objetivo da remediação é alcançado quando as concentrações em todos os pontos de remediação e monitorização da área de interesse não excedem os objetivos de remediação (screening values). Esta abordagem representa uma tolerância zero em relação a exceder os objetivos de remediação e conduz a resultados óptimos. Pode, contudo, conduzir a custos de remediação excessivos, especialmente no caso de condições naturais complicadas em que uma localização e quantidade de contaminação no subsolo ou uma inatingibilidade dos alvos não possam ser definidos com precisão em condições técnicas e económicas aceitáveis.
- O objetivo da remediação é alcançado quando as concentrações na maioria dos pontos de remediação e/ou monitorização de uma área de interesse não excedem os objectivos de remediação. Por exemplo, 20% excede um valor intransponível especificado, de acordo com o tipo de contaminante. Este método representa uma abordagem estatística admissível de exceder os parâmetros alvo de remediação até um certo grau de tolerância. Neste caso, os pontos de monitorização devem ser considerados indicativos e distribuídos de forma representativa por toda a área de interesse, de modo a que a concretização dos parâmetros de remediação alvo possa ser objetivamente avaliada, em particular em relação à área original da pluma de contaminação. Os resultados da monitorização são então

processados e interpretados estatisticamente. Pontos que representem locais com valores extremos e pontos que representam a maior parte do espaço da área de interesse são tratados de forma diferente.

- O parâmetro de remediação alvo é alcançado após a remoção/estabilização de uma parte especificada do contaminante. Esta abordagem prevê uma avaliação baseada numa avaliação de balanço da quantidade de contaminação antes e depois do fim da remediação.
- O parâmetro alvo é alcançado quando o risco de contaminação presente no ambiente tiver sido reduzido ao nível mais baixo aceitável, com intervenção de remediação técnica e economicamente aceitável e justificável. Esta abordagem permite pôr fim à intervenção de remediação quando a contaminação residual não representa um risco acrescido para o ambiente e, ao mesmo tempo, a sua eliminação total exigiria uma intervenção técnica e economicamente intolerável.

Se os parâmetros de remediação alvo forem alcançados, devem ser acrescentados outros passos de monitorização.

5.2.3 Monitorização pós-remediação

O objetivo é demonstrar a sustentabilidade dos parâmetros alvo de remediação atingidos. Neste caso, a tarefa é também puramente específica para as condições da área de interesse. A sustentabilidade dos parâmetros-alvo da remediação só pode ser demonstrada através de uma monitorização a longo prazo em pontos de monitorização selecionados (pontos críticos e uma saída de águas subterrâneas do local). Na maioria dos locais, é de esperar um aumento subsequente das concentrações de contaminantes monitorizados após o fim da intervenção activa.

Os indicadores comumente monitorizados são pH, temperatura e condutividade nas águas subterrâneas, reagentes usados, contaminantes e, por último, mas não menos importante, produtos de decomposição. A amostragem deve ser feita de uma forma dinâmica. Alguns contaminantes, tais como hidrocarbonetos clorados, decompõem-se em produtos (percloroetileno - cloreto de vinilo) que são mais tóxicos do que o contaminante principal. Estes produtos de decomposição, tóxicos, não podem sair do local.

O período de monitorização deve ser suficientemente longo, frequentemente 3-5 anos, e depende das condições hidrogeológicas, do tamanho do local e possivelmente da quantidade de contaminante no subsolo. O período de monitorização deve também incluir a possibilidade de um efeito de retorno de contaminante, ou seja, um aumento das concentrações de contaminantes depois de a remediação ter sido considerada completa. Como regra, o agente oxidante reage com a fração dissolvida dos contaminantes nas águas subterrâneas. Contudo, fontes de contaminação secundária baseadas no fundo do coletor sob a forma de uma fase livre de contaminante (DNAPL - Líquidos Densos de Fase Não-Aquosa); entrada no coletor a partir numa zona insaturada que por lavagem através da chuva; ou mesmo uma fonte situada fora do local, gera que após algum tempo haja novo aumento de concentração de contaminantes nas águas limpas. O maior aumento pode ocorrer no local onde a remediação apenas removeu parcialmente a poluição e onde a fase livre permanece no subsolo. Do ponto de vista hidrogeológico, o período de monitorização pós-sanitária deve depender da taxa de fluxo e migração da contaminação, de modo a que toda a área da pluma de contaminação original e as suas imediações sejam monitorizadas durante os primeiros anos, após o final da remediação.

5.2.4 Processamento da análise de risco actualizada após a conclusão da remediação

O relatório final da remediação e o relatório de monitorização pós-saneamento poderão ser seguidos por uma análise de risco actualizada que será preparada com base na monitorização contínua, final e pós-saneamento. Não é previsível qualquer trabalho adicional de natureza técnica no processamento da análise de risco actualizada. A análise actualizada avaliará os riscos decorrentes da poluição residual no local.

A aplicação de métodos redutores *in situ* pode ser acompanhada por alguns problemas técnicos. É, por exemplo, necessário verificar a presença de vias prioritárias para a disseminação de reagentes - fugas a partir de infraestruturas subterrâneas armazenadas sob as águas subterrâneas que podem drenar para as águas subterrâneas e/ou drenar os reagentes aplicadas para fora da área de remediação. Uma fuga do reagente residual para uma estação de tratamento de águas residuais e, subsequentemente para um sistema de águas superficiais pode causar problemas, assim como a contaminação dos poços circundantes com o reagente.

6 CONCLUSÕES

A ISCO é uma família de tecnologias de remediação em evolução contínua, que inclui muitos agentes oxidantes, muitas vezes envolvendo uma química complexa. A ISCO pode ser considerada como uma abordagem agressiva. É frequentemente selecionada como tecnologia de remediação quando um dos critério chave é um período de tempo limitado para a remediação. Contudo, para aumentar a eficiência e sustentabilidade da remediação, a ISCO deve ser avaliada como parte de uma abordagem integrada, constituída por uma sequência de tecnologias. A oxidação química é uma tecnologia de intervenção utilizada principalmente na zona saturada (as águas subterrâneas) e para áreas da fonte, enquanto que a aplicação no solo superior, insaturado e em meio saturado de água dentro de áreas de pluma, deve ser cuidadosamente avaliada.

A avaliação de viabilidade de uma intervenção ISCO deve, em qualquer caso, ser realizada tendo em conta os objetivos necessários para o tratamento, independentemente de estar incluída numa intervenção que consista numa mistura de tecnologias ou caso seprevista como uma atividade autónoma. A localização do contaminante no subsolo pode fornecer uma primeira orientação da avaliação de viabilidade, mas tendo como objetivo aumentar a probabilidade de sucesso e eficiência do tratamento com oxidantes químicos, os seguintes fatores-chave devem ser tomados em consideração:

- modelação precisa das características hidrogeológicas, para assegurar a distribuição eficaz dos agentes oxidantes e calcular o raio de influência, em função da heterogeneidade da área a tratar;
- caracterização geoquímica adequada, para calcular o consumo de oxigénio por substâncias que não fazem parte do objetivo do tratamento (carência natural de oxigénio);
- caracterização 3D da contaminação associada às características lito-estratigráficas, a fim de verificar as áreas de acumulação de contaminantes e as áreas de dispersão de contaminantes;
- avaliação de múltiplas alternativas de intervenção na fase de pré-projeto, construída com uma abordagem integrada, para identificar a sequência de tecnologias que maximizam a eficiência durante todo o processo de remediação;
- realização de testes de laboratório e/ou de campo para reduzir a incerteza na fase de conceção da intervenção;
- realização de um controlo à escala real para verificar os objetivos de remediação.

REFERÊNCIAS

Os documentos são citados por ordem alfabética como: [Autor/es, Ano, Título, #]

- Agència de Residuos de Catalunya, 2014, Guía técnica para la evaluación de la problemática del subsuelo asociada a los compuestos organoclorados
http://residus.gencat.cat/web/.content/home/lagencia/publicacions/sols_contaminats/guia-tecnica-compuestos-organoclorados-ARC.pdf
- Compuestos orgánicos tóxicos,
https://www.ugr.es/~fgarciac/pdf_color/tema11%20%5BModo%20de%20compatibilidad%5D.pdf
- CRC CARE, 2018, Technology guide: In-situ chemical oxidation, consulted at
https://www.crccare.com/files/dmfile/ITechguide_ISCO_Rev0.pdf
- Dal Santo, M., & Prosperi, G. (2020). Application of chemical reagents as innovative remediation technologies for groundwater impacted by petroleum hydrocarbons in Italy. *Acque Sotterranee - Italian Journal of Groundwater*, 9(1). <https://doi.org/10.7343/as-2020-419>
- Discovered life project 2021, <http://en.lifediscovered.es/>
- FAO 1998, Obsolete pesticides brochure <http://www.fao.org/NEWS/1998/img/pestbroc.pdf>
- Scott G. Huling, Bruce E. Pivetz, 2006, In-Situ Chemical Oxidation
- ITRC 2005, Technical and Regulatory Guidance for In Situ Chemical Oxidation of Contaminated Soil and Groundwater, consulted at <https://www.itrcweb.org/Guidance/>
- ITRC, 2020, Optimizing Injection Strategies and in situ Remediation Performance. OIS-ISRP-1. Washington, D.C.: Interstate Technology & Regulatory Council, OIS-ISRP Team. consulted at <https://ois-isrp-1.itrcweb.org/3-amendment-dose-and-delivery-design/>
- Keita Nakamura, Mamoru Kikumoto, 2014, Modelling water–NAPL–air three-phase capillary behaviour in soils <https://doi.org/10.1016/j.sandf.2014.11.015>
- Timothy J. Pac James Baldock Brendan Brodie Jennifer Byrd Beatriz Gil Kevin A. Morris Denice Nelson Jaydeep Parikh Paulo Santos Miguel Singer Alan Thomas, In situ chemical oxidation: Lessons learned at multiple sites First published: 28 February 2019, <https://doi.org/10.1002/rem.21591>
- Regenesis 2016, Principles of chemical oxidation technology for the remediation of groundwater and soil - Design and Application Manual V.4.0, 2016, consulted at https://regenesis.com/en/techinfo/regenox-application-manual/USEPA_1994, In Situ Chemical Oxidation (ISCO) treatment technology resource guide, EPA/542-B-94-007, freely downloadable at https://www.epa.gov/sites/production/files/2015-08/documents/ISCO_tt_res_guide.pdf
- USEPA 1997, Analysis of Selected Enhancements for In Situ Chemical Oxidation, EPA-542-R-97-007, consulted at <https://clu-in.org/download/remed/ISCOenhmt.pdf>
- USEPA 1998, Field Applications of In Situ Remediation Technologies: Chemical Oxidation <https://www.epa.gov/sites/production/files/2015-04/documents/chemox.pdf>
- USEPA 2006, In-Situ Chemical Oxidation Engineering Issue, August 2006, EPA/600/R-06/072, consulted at <https://nepis.epa.gov/Exe/ZyPURL.cgi?Dockkey=2000ZXNC.TXT>
- USEPA 2012, https://clu-in.org/download/Citizens/a_citizens_guide_to_in_situ_chemical_oxidation.pdf
- Muhammad Usman, Oriane Tascone, Victoria Rybnikova, Pierre Faure, Khalil Hanna, 2017, Application of chemical oxidation to remediate HCH-contaminated soil under batch and flow through conditions. DOI 10.1007/s11356-017-9083-5
- John Vijgen, Christian Egenhofer 2009, Lethal Obsolete Pesticides. A ticking time bomb and why we have to act now https://obsoletepesticides.net/site/wp-content/uploads/resources/reference/a_ticking_time_bomb_english_.pdf



European Union Network for the Implementation
and Enforcement of Environmental Law

Annex 1

In Situ Chemical Oxidation – Case studies

IMPEL Project no. 2020/09



1. Contact details - CASE STUDY: ISCO n.1

1.1 Name and Surname	Marcello Carboni
1.2 Country/Jurisdiction	Italy
1.3 Organisation	REGENESIS
1.4 Position	Regional Manager, Europe
1.5 Duties	Coordination of Sales and Technical teams within Europe
1.6 Email address	mcarboni@regenesi.com
1.7 Phone number	+39 335 5867213



2. Site background

2.1 History of the site: Challenges and Solution

Site located in Veneto Region, Italy

A fuel tanker truck over-turned on a small road in northern Italy, spilling over 36,000L of diesel and petrol. The fuel impacted a canal, flood defences, soils and groundwater in the immediate vicinity.

The accidental event happened the 25th August 2017.

Emergency oil spill response was carried out, with impacted soils and the road surface removed and replaced. An underground pipeline was flushed out and sorbent booms were placed in the adjacent canal to catch and remove the oil.

A site investigation was completed concurrently with the oil-spill response in order to identify the subsurface contamination, build an initial Conceptual Site Model (CSM) and develop plans for remediation. MTBE, petroleum hydrocarbons (TPH) and BTEX were found to be within the soil – concentrated within the capillary fringe.

The groundwater was also found to be impacted and requiring remediation. A remedial options appraisal was completed, considering technical feasibility, sustainability, time and cost and a combined in situ chemical oxidation (ISCO) and enhanced aerobic natural attenuation (ENA) approach was chosen.

Main challenges of the site are related to:

- Urgency to complete remediation and allow area to go back to original conditions
- Public areas, no services available,
- No presence of fences, no surveillance
- Presence of MTBE (highly mobile) in a recent pollution event poses risk for rapid formation of plume of big size
- Different matrices interested: vadose zone soil, soil in capillary fringe, groundwater

2.2 Geological and hydrogeological setting

- Intercalation of fine sands with silts
- Unconfined aquifer with groundwater table at 2.5 m BGL
- Bottom of the aquifer at 5-6 m BGL (clay)
- Unknown specific data on conductivity and porosity
- Hydraulic gradient approx 0.5%

NOTE		CAMPIONI			LIVELLO ACQUA	PROF. FORO	PROF. RIVEST.	ASSISTENTI	
		● SPT	○ CAMPIONI RIMANEGGIATI	■ CAMPIONI INDISTRIBUITI	DATA	M. da S.P.		R. Sacchetti, A. Pini	
					05/07	100m	±0,0m	±0,0m	OPERATORE G. Rossi
mt.	QUOTA da P.C.	SIMBOLOGIA	CAMPIONI			DESCRIZIONE STRATIGRAFICA	PROF. (m)	TUBO (m)	PROF. (m)
			TIPO	NUM.	PROF.				
	0,20								
1									
	1,40								
2									
	2,80								
3									
	3,80								
4									
	4,70								
5									
	5,20								
6									
	8,70								
9									
	9,40								
10									
	10,00								

2.3 Contaminants of concern

- Soil impacted with TPH and BTEX
- Groundwater impacted with MTBE and TPH
- Targets for soils: CSC residential areas:
 - C>12: 50 mg/kg
 - C<12: 10 mg/kg
 - B: 0.1
 - T: 0.5
 - EB: 0.5
 - X: 0.5
- Targets for groundwater: CSC:
 - TPH: 350 µg/l
 - MTBE: 40 µg/l
- Exceedings in soil in table below
- Exceedings in groundwater <1 mg/l for both TPH and MTBE

Campione	DATA	IDROCARBURI PESANTI C>12	IDROCARBURI LEGGERI C<12	BENZENE	TOLUENE	ETIL BENZENE	XILENI
		mg/kg					
FS1 VASCA	29/08/2017	1564	41	< 0,01	0,03	0,23	3,05
FS2 VASCA	29/08/2017	1703	52	0,06	3	1	2
M5C3 (2-2,4m)	04/09/2017	11327	361	0,21	5,54	2,23	3,41
M4C3 (2-2,8m)	04/09/2017	5094	39	< 0,01	0,02	0,04	0,41
PZ7C (2,0-3,0)	07/09/2017	118	8	< 0,01	< 0,01	< 0,01	0,01
PZ6C (2,0-3,0)	06/09/2017	246	15	< 0,01	< 0,01	< 0,01	0,03
CSC Tab. 1 Colonna B		750	250	2	50	50	50
CSC Tab. 1 Colonna A		50	10	0,1	0,5	0,5	0,5



2.4 Regulatory framework

- In Italy, CSC values define potentially contaminated sites. These are table limits.
- You can run risk assessment to find CSR: risk based threshold values, which can be less stringent as CSC and define site specific goals
- In this case, due to the limited size of the site, risk assessment has not been performed. Therefore targets for the remediation equal the national wide table limits CSC, specified at point 2.3
- A remediation plan needs to be submitted to the competent local authorities.
- Once the remediation plan has been submitted, the Municipality needs to call a meeting for its discussion, together with other technical and administrative authorities.
- If the project is approved, the proponent needs to pay a guarantee and then can start the works within the timeframe defined in the approval

3. Laboratory-scale application in field

3.1 Laboratory scale application

- Laboratory testing was not required and has not been performed
- Lab testing is seldom required by clients or authorities in Italy, and they are rarely performed
- Lab testing rarely can be useful for scaling up on site, and frequently is not representative, as it is difficult to simulate site conditions on a lab scale.
- If needed, a field pilot test, of small size, can provide at approximately the same cost more reliable and representative information.



4. Pilot-scale application in field

4.1 Main treatment strategy

- No pilot activity has been performed in this site
- This is because of the limited size of the site, and also for necessity of arriving to closure as soon as possible
- Therefore the strategy, the dosing and the activities have been designed based on previous experience on similar sites.



5. Full-scale application

5.1 Main Reagent

- General strategy was the use of ISCO coupled with EAB on both fringe soil and groundwater
- The strategy was selected after a multicriterial analysis comparing different strategies, taking into account logistics, timing, efficiency, consolidation of the technique, costs.
- The selection has been made thanks to the fact that no installation of active plants was needed, which would have been difficult to install and maintain on a public area without surveillance, the ease of use and the minimization of site activities
- RegenOx[®] is the ISCO agent selected. It is a patented formulation with catalyzed sodium percarbonate. Main reasons for selecting this specific reagent have been: ease of use, it is less dangerous compared to other ISCO agents (accidental contact with workers does not cause major issues), it is perfectly compatible with any kind of material (doesn't cause corrosion), and has a Strong desorbing effect (which was used in this case). Is also perfectly compatible with ORC oxygen release compound, which made it possible to co-inject together.
- Two different ways of application, at a distance of few days: first a direct application into excavation: product applied inside the excavation using the excavator, and mixing with saturated soil and groundwater. This caused an immediate desorbing effect (thanks to desorbing properties of RegenOx[®]), and direct recovery of LNAPL. At the end ORC was directly applied to excavation.
- Total size of excavation: 70 m². Dosage: RegenOx[®] Part A (based mainly on sodium percarbonate) 220 kg; RegenOx[®] Part B (catalyst, based on iron silicate): 110 kg. ORC (calcium peroxide) 125 kg.
- Secondly, application by direct push has been made in the areas surrounding the excavation. It has been co-applied again RegenOx[®] + ORC, in capillary fringe and groundwater.
- It has been applied on a regular grid with distance of 3 meters,
- Total of 16 injection points, treatment over a layer of 2 meters (from 2 to 4 m BGL)
- Dosage per single point: RegenOx[®] Part A: 18 kg; RegenOx[®] Part B: 18 kg; ORC-Advanced 25 kg.
- The RegenOx[®] has been dissolved in water, forming a solution of 380 litres per



point. Usual dilution factors used for this reagent is 4-8% of RegenOx[®] Part A mass in water. After complete dilution, RegenOx[®] Part B is added (it is already a liquid/gel)

- Immediately after this, ORC powder has been put in water, and mixed, forming a slurry, for a volume of 125 litres per point.
- All field works have been performed in 1 week time.

5.2 Additives

- RegenOx[®] is a bicomponent ISCO agent
- In order to make reactive the sodium percarbonate (RegenOx[®] Part A), it is needed to have a catalyst (RegenOx[®] Part B).
- Usual dosages for RegenOx[®] Part B range from 50% to 100% of RegenOx[®] Part A. In this case it has been applied 50% in the excavation and 100% in direct push
- RegenOx[®] Part B is a liquid/gel composed mainly by iron silicate. Once in groundwater, it creates a matrix/surface on which both the oxidizer and the contaminants are attracted. This mechanism increases the probability and the velocity of direct contact between oxidizer and contaminants

5.3 Injection type

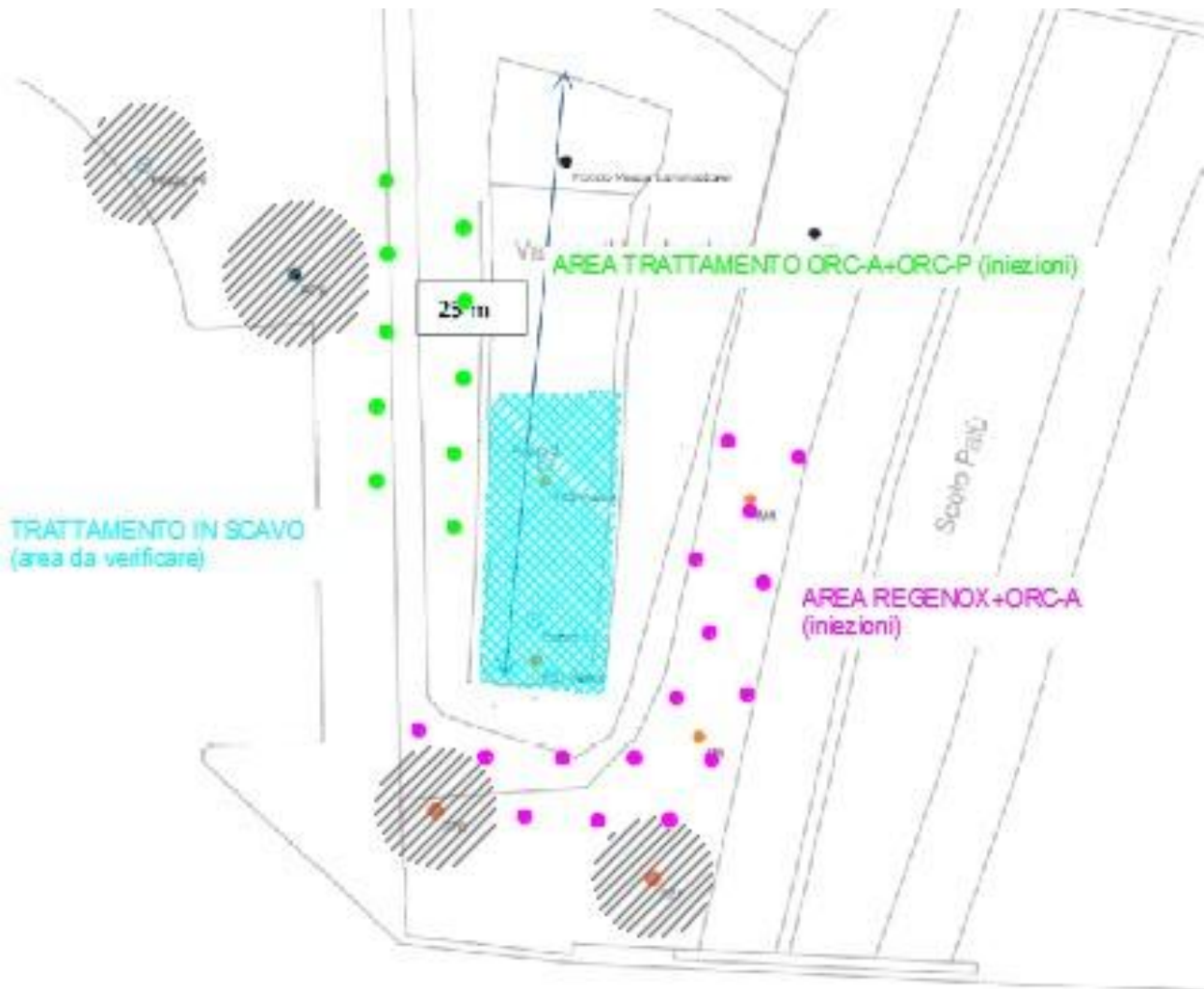

- 2 ways of application: direct application into excavation and direct push injection
- For direct push, regular grid of 3 x 3 meters distance. There was no direct verification of radius of influence, but has been selected this interdistance based on experience and observance in similar sites.
- Layer from 2 to 4 m BGL. Groundwater level is approx at 2.5 meters. So this layer covers fringe soil, periodical fluctuation zone of groundwater, and the first 1.5 meters of aquifer. Not all aquifer treated, as LNAPL tend to accumulate on first part.
- Just one single injection campaign performed. This is not very common for RegenOx®, most frequently we perform 2-3 campaigns at a distance of 1 month, to manage rebound. In this case the majority of the mass was MTBE, a hydrophilic



contaminant, which doesn't sorb that much to saturated soil, so 1 campaign has been considered sufficient.

- See previous paragraphs for dosing
- No fracturing used. Has been injected at relatively low pressure (2-4 bars). High pressure fracturing can cause formation of preferential pathways and lack of treatment in areas which ISCO agent can't access.

5.4 Radius of influence

- No direct measurement or calculation of radius of influence on this site
- The interdistance selected was 3 meters, estimating a ROI of approx 1.7-1.8 meters, therefore allowing for some overlapping between ROI in the treatment area
- This has been selected based on experience acquired on similar sites.
- Typical interdistances used for RegenOx[®] range from 3 to 4-5 meters. In this case the minimum value has been used, due to the relatively low permeability of the soil

5.5 Process and performance monitoring

- pH, redox, dissolved oxygen, temperature have been measured on site using multiparametric survey (field measurement)
- Parameters measured once per month for a period of 2 years, the same day as groundwater sampling for contaminants of concern
- Especially pH, redox and dissolved oxygen have been helpful in understanding the ongoing of the treatment
- Also monitoring of metals included, together with contaminants of concern. Same frequency and duration (once per month for 2 years)
- Analyzed in laboratory
- Metals searched: iron, manganese, total chromium, chromium VI. No variations have been noted that could be related to the treatment.

6. Post treatment and/or Long Term Monitoring

6.1 Post treatment and/or Long Term Monitoring

Fig. 7 MTBE monitoring results over time

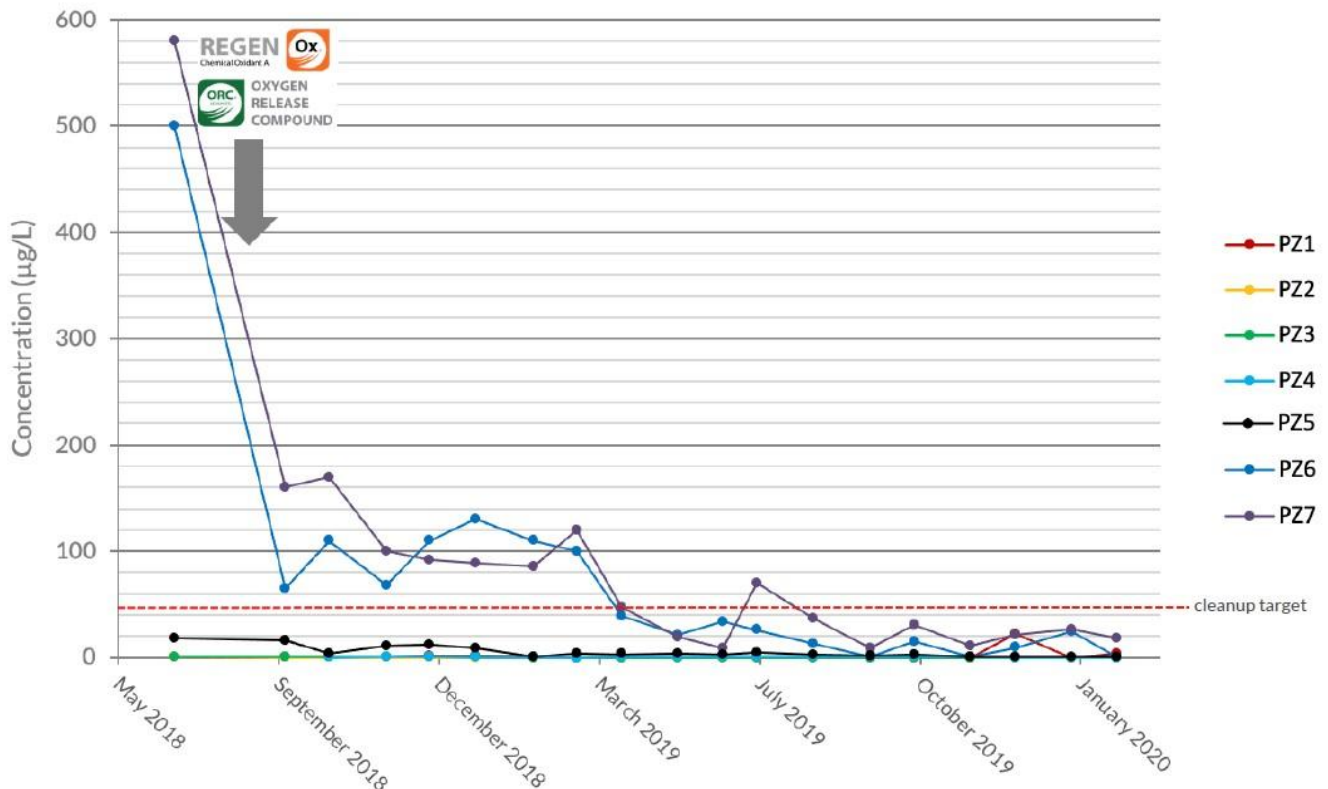

- Contaminants of concern monitored each single month for 2 years after application.
- Contaminants monitored: TPH, BTEX, MTBE, ETBE
- After the 2 years monitoring, formal compliancy of the site observed (reduction of contaminants of concern, and observance of no rebound in the following period). This was achieved in February 2020.
- After that, there is an additional post-operam monitoring period (still ongoing) of 2 year, with analysis every 3 months, to confirm that no increase of concentrations is observed.
- Also soil in capillary fringe has been tested for compliance after treatment. This has been performed through 4 soil borings, and analysis for compliancy of CSC, which was achieved in all 4 points.
- For groundwater, main contaminant was MTBE. TPH, originally present in groundwater above CSC, was already below CSC before ISCO application, probably thanks to the primary removal of source (excavation) made as emergency measurement (MISE)

- For groundwater, Pz5 Pz6 Pz7 are the wells inside the treatment area. The others are more downgradient.

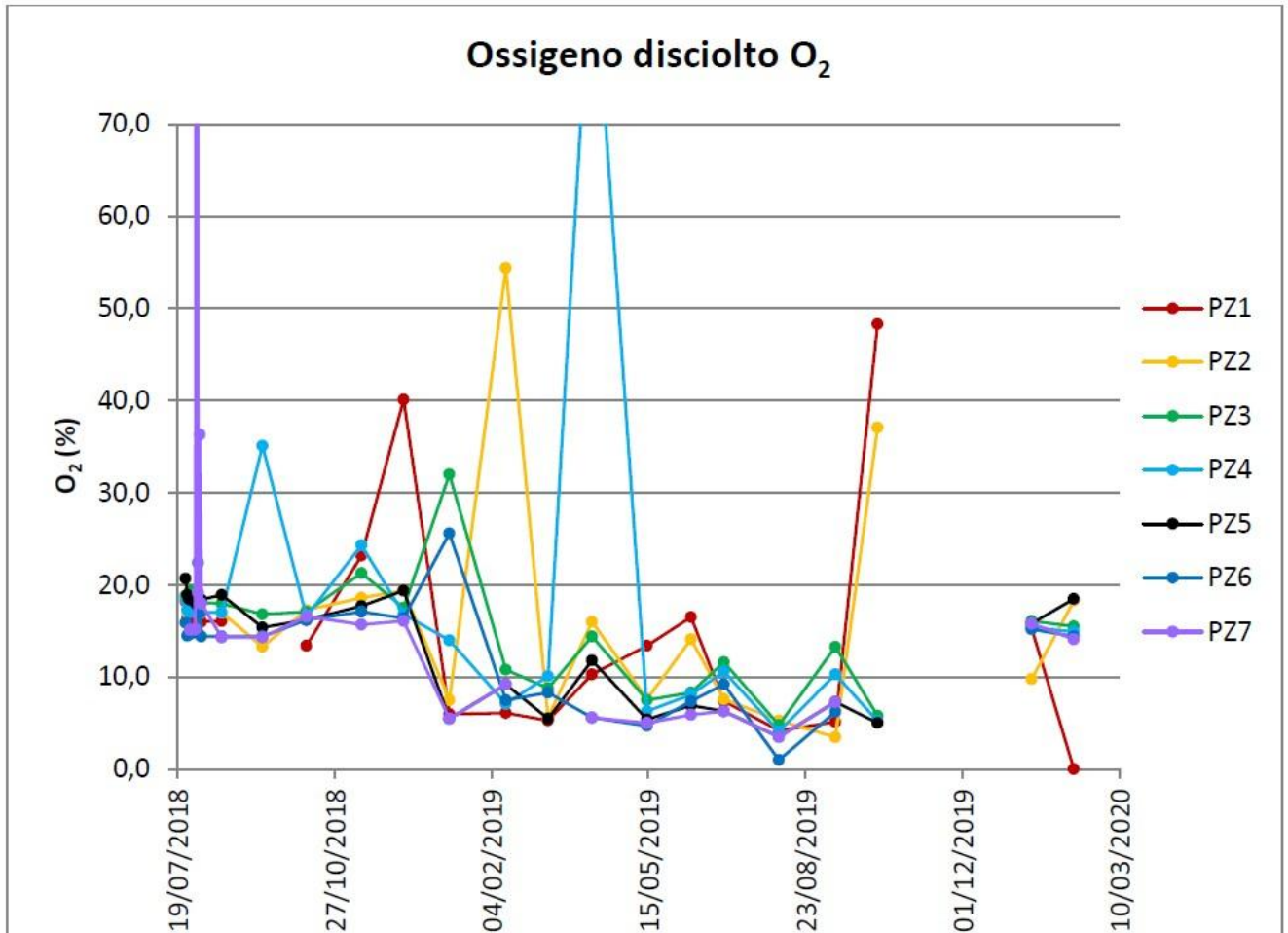

7. Additional information

7.1 Lesson learnt

- Very effective and rapid treatment. This is much faster compared to usual timing on treatment of groundwater in Italy, due to usually slow bureaucratic process
- Only 2 years between contamination event and formal achievement of compliancy of the site.
- Quick process has been achieved thanks to management of some parts in parallel (emergency activities and investigation)
- Also direct involvement and open discussion with local authorities was crucial for getting authorization on time
- Velocity of the process was crucial for not allowing formation of a bigger plume.
- Area accessibility was difficult, being present canals, tanks and private



surrounding areas. Therefore the treatment areas have been adjusted accordingly, but this hasn't affected the treatment efficiency

- No other parameters measured apart from the ones already mentioned.

7.2 Additional information

- Experience is very important, and is usually acquired thanks to management of many sites
- Field pilot test is highly recommended in any case, but it could be avoided for small sites like this one
- Dosing and design can't be based only on stoichiometry. Anyway, stoichiometry needs to be based on total contaminant mass (dissolved phase, sorbed phase to soil, NAPL), and not all of them are always directly known. For example in Italy saturated soil is never analyzed, and this is where the majority of the mass usually stands. This means that the mass of contaminant can be an imprecise estimation.
- Apart from stoichiometry, other factors on which to be based are distribution of the reagent, and minimum dosage required.
- Before getting in charge for an ISCO design, it needs to be evaluated if the technology is feasible. This needs to be done taking into consideration: geology, concentrations, targets, depth, accessibility of the area.
- The selection of the specific reagent can't be based only on reactivity, but needs to take into account longevity, distribution and ease of use. There are general rules and outlines, but is preferable to make these evaluations site-specific.

7.3 Training need

- I think the most useful thing is to get many examples of treatments done, in order to have an idea of how an average treatment should look like
- Too many times I see treatments performed using unrealistic designs, meaning interdistance between points too wide, wrong application method (i.e. gravity feeding of wells), very low quantities of amendments. In some cases there are examples of distances that could not be considered applicable in any case.
- Workshops and webinars are probably the most effective ways for training
- Visit to some sites where application is ongoing also is a very useful instrument to have a good idea of what is being done.

1. Contact details - CASE STUDY: ISCO n.2

1.1 Name and Surname	Federico Caldera
1.2 Country/Jurisdiction	Italy
1.3 Organisation	Mares S.r.l.
1.4 Position	Analista Sviluppo & Compliance
1.5 Duties	Sanitary and environmental risk assessment, innovative remediation and characterization technologies development
1.6 Email address	federicocaldera@maresitalia.it
1.7 Phone number	+39 3497616386

2. Site background

2.1 History of the site: Challenges and Solution

The site is a gas station, with an adjacent private property in a city of northern Italy, where at least starting from 1959, the marketing of petroleum products for motor vehicles, refuelling of motor vehicles, sale of lubricants and oil change of cars have been carried out. A contamination of TPH and BTEX affecting soil and groundwater (with also LNAPL) was found there in 2006. Thus a groundwater and unsaturated soil remediation plant was installed using MPVE technology. The project approved by the local authorities provides, where the remediation interventions through MPVE have not reached the identified remediation objectives within the set time frame, a Second Remediation Phase through the possible application of ISCO technology. So ISCO was chosen in order to remediate the presence of MTBE in groundwater outside the site.





2.2 Geological and hydrogeological setting

The site is located on the southern shore of Lake Maggiore, in a sub-flat area. The Quaternary deposits constituting the subsoil of the study area are characterized by fine sands and silty sands of fluvial and lake origin.

The area in question is located in an area characterized by the presence of alluvial, current fluvial and fluvio-glacial deposits with little or no surface alteration layer.

The gas station area hosts a water table with an average subsidence of 3.5 m b.g.s. and outflow facing Lake Maggiore towards the east quadrant.

2.3 Contaminants of concern

As anticipated the historical contamination affected both soil and groundwater, with BTEX, TPH and MTBE as CoCs.

After the first phase of the remediation the groundwater samples showed the presence of MTBE, downgradient outside the site, with concentrations historically ranking up to about 1000 micrograms per liter.

2.4 Regulatory framework

In Italy the environmental regulatory system is regulated by Legislative Decree No. 152/06 and for fuel stations by the Ministerial Decree No. 31/15. The target value for MTBE is set equal to 40 micrograms per liter. For the implementation of ISCO technology with subsequent injections of chemical reagents in groundwater (as well as for the implementation of any remediation plan) the approval by local authorities is needed.



4. Pilot-scale application in field

4.1 Main treatment strategy

ISCO technology is a technique that involves injecting an oxidant into the subsoil to chemically treat polluting organic compounds and transform them into harmless substances.

The execution of the field test had a dual purpose: to verify the applicability of the chemical oxidative treatment against residual contaminants present in the groundwater (MTBE) and ascertain the path of the oxidizing solution in the subsoil, in order to dimension the interventions planned for the second phase of remediation.

The solution used is composed of an oxidizing complex based on sodium persulfate activated with calcium peroxide.

The chemical reactions caused by the use of this specific compound are:

- direct chemical oxidation in the short term;
- biological degradation in the long term.

Sodium persulfate breaks down in water generating persulfate anions ($S_2O_8^{2-}$), creating a strongly oxidizing alkaline environment.

The persulfate oxidation reactions involves the transfer of 2 electrons and is influenced by the concentration of anions, pH and oxygen.

In order for the contamination to degrade, the persulfate anion must be activated in order to generate the sulfate radical. The activated persulfate increases its oxidizing power, as the radicals are molecular fragments with an extremely reactive unpaired electron.

As for the biological action in the long term, the generic degradation of hydrocarbon compounds is the work of sulfur-reducing bacteria.

4.2 Additives

The activation energy of the persulfate is provided by calcium peroxide, which also has the function of regulating alkalinity (restoring a basic environment) and slowly releasing hydrogen peroxide and calcium hydroxide, with formation of hydrogen peroxide.

Hydrogen peroxide breaks down into oxygen and water, playing the role of a source of oxygen necessary for the decomposition of hydrocarbons.

The redox potential of sodium persulfate is 2.12 V, and it is the strongest oxidant of the peroxide family.

4.3 Injection type

The pilot test was performed by injecting in the subsoil an oxidizing solution, consisting of the commercial product diluted to approximately 10% with water, at 10 injection points (PI01 to PI10): 2 spaced 5 m each other near PZ12 and 8 spaced 5 m each other in a grid, compatible with the underground utilities, around PZ11 (see picture below).

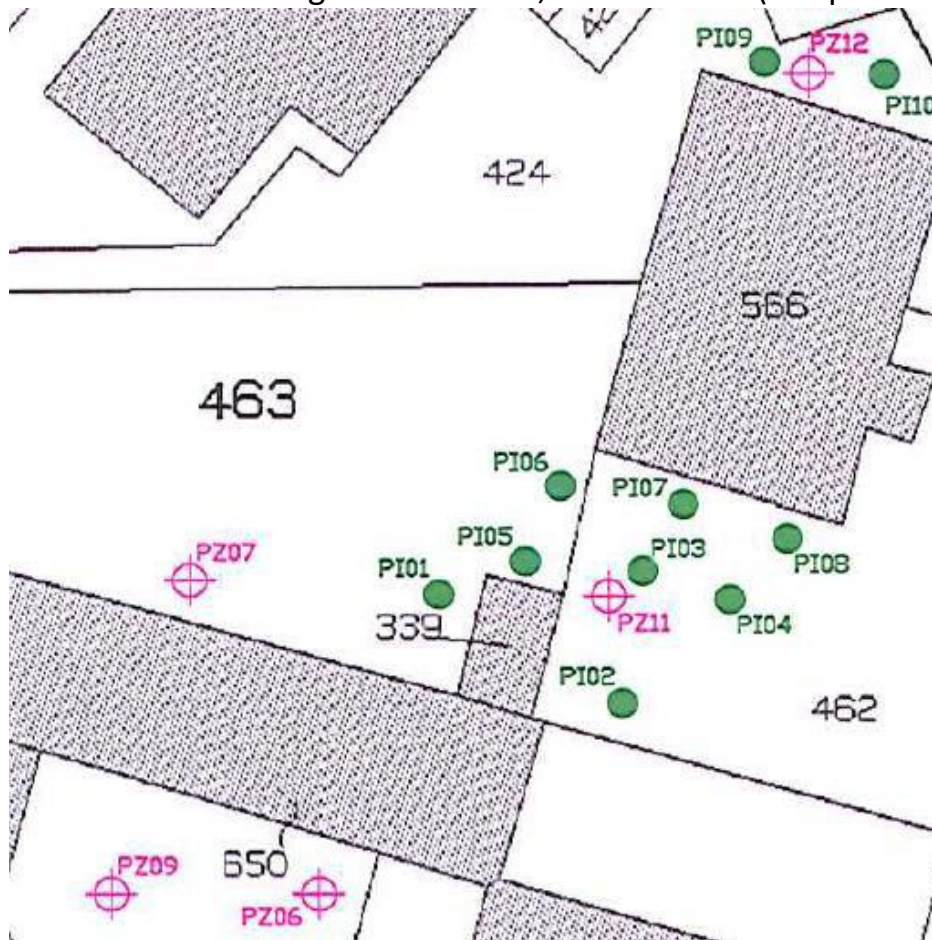

The injection took place using a direct-push technique, which involved driving a 1" hollow shaft into the subsoil, from whose terminal filter tip the oxidizing solution was injected under pressure at pre-established depths.

During the test, a solution consisting of about 2.7 m³ of water mixed with 300 kg of the product was introduced into the aquifer for each of the 10 injection points.

Along the 10 verticals 7 sub-injections were carried out, proceeding in ascent from the bottom upwards in steps of 1 meter, i.e. from the bottom of the hole, located about 9 m b.g.s., up to the capillary fringe, about 3 m b.g.s.

The total quantity of oxidizing solution used at the end of the test was approximately 27 m³ of water and 3 tons of the commercial product.

4.4 Radius of influence

The oxidant solution injected into the aquifer immediately generated positive redox potentials in all the monitoring points considered with values, gradients and longevity directly proportional to the distance between the monitoring points and the intake area, with effects observed also in PZ07 at about 10 m from the nearest injection point and in PZ06 at about 15 m from the nearest injection point (see the picture below with ORP values observed after the injection of oxidant solution). Moreover, the infiltration and drainage capacity of the oxidizing solution was not affected by the fine particle size that characterizes the subsoil in question (sandy silt and silty sand). To confirm this, in the multiple injection phase by direct-push, with a distance between the injection points of about 5 m, there were no problems of soil super saturation and it was therefore possible to inject all the quantity of oxidizing mixture expected, so such distance between the injection points was able to guarantee an overlap of ROI.

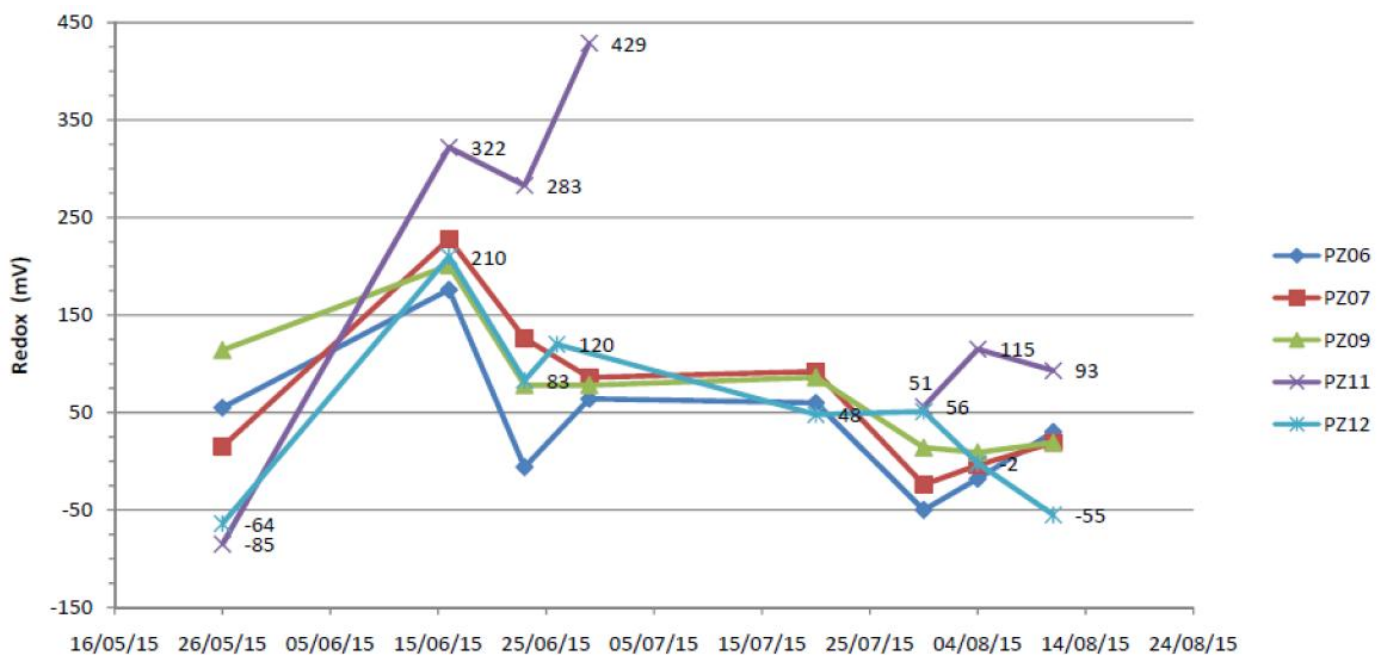



4.5 Control parameters

The monitoring of the chemical-physical parameters of the groundwater took place, on a network of 5 monitoring wells, with periodic frequency (approximately every 7 days), by measuring the pH and redox potential with a multiparameter probe directly in well at 3 increasing depths with respect to the free surface of the aquifer (at -1, -2 and -3 m below groundwater level), or on the ground level with field probe and flow cell for the water collected at -1 m depth compared to the free surface of the water table.

For the measurements carried out with a multi-parameter probe, it was also possible to record further parameters such as temperature, electrical conductivity, dissolved oxygen (expressed in mg/l and in %) and salinity.

It should be noted that after the injections of the oxidant solution into the aquifer it was not possible to measure the oxygen parameter dissolved in the water (mg/l and %) due to the possible aggressiveness of the product towards the measurement sensor.

The measures of chemical-physical parameters took place at the following time intervals:

- T0 baseline time (13 days prior to the first campaign),
- T1 time (4 days after the first injection),
- T2 time (11 days after the first injection),
- T3 time (17 days after the first injection),
- T4 time (38 days after the first injection),
- T5 time (48 days after the first injection),
- T6 time (53 days after the first injection),
- T7 time (60 days after the first injection).

The test included the analytical determinations on the whole piezometric network involved in the test, of the following parameters:

- Benzene, Ethylbenzene, Toluene, p-Xylene,
- Total hydrocarbons (such as n-hexane),
- MTBE,
- Lead,

in the following time intervals:

- T0 baseline time (13 days prior to the first campaign),
- T3 time (17 days after the first injection),
- T4 time (38 days after the first injection),
- T7 time (60 days after the first injection).



5. Full-scale application

5.1 Main Reagent

No changes from pilot test

5.2 Additives

No changes from pilot test

5.3 Injection type

In detail, the injection of an activator/buffer based on calcium peroxide in the hydrogeological valley area of the site was carried out by placing a solution in the subsoil, consisting of activator diluted 10% with water, at 10 injection points, named from PI01 to PI10. In the points where the injected reagent was absorbed with difficulty, in order to allow complete absorption of the same, i.e. in correspondence with points PI01, PI04 and PI10, new perforations were made as close as possible to the points of origin (i.e. PI01bis, PI04bis, PI10bis), see picture below. The injection took place using a direct-push technique which involved driving a 1" hollow rod into the subsoil, from whose terminal filter tip the solution was injected under pressure at predetermined depths.

During the activity, a solution consisting of 0.9 m³ of water mixed with 100 kg of activator was introduced into the aquifer for each of the 10 injection points.

Along the 10 verticals 7 sub-injections were carried out, proceeding in ascent from the bottom upwards in steps of 1 meter, i.e. from the bottom of the hole, located about 9 m b.g.s., up to the capillary fringe, about 3 m b.g.s.

The injection of the oxidant solution with sodium persulfate in the PV area was performed by placing in the subsoil the solution, diluted to 7.5% with mains water, at 6 injection points, named by PI01 to PI06, see picture below.

The injection took place using a direct-push technique which involved driving a 1" hollow rod into the subsoil, from whose terminal filter tip the solution was injected under pressure at predetermined depths. The perforations were preceded from vacuum-digging pushed up to 1.5 m depth b.g.s. to verify the presence of any underground services.

During the activity, a solution consisting of approximately 1.7 m³ of water mixed with

140 kg of sodium persulfate was introduced into the aquifer for each of the 6 injection points.

Along the 6 verticals 7 sub-injections were carried out, proceeding in ascent from the bottom upwards in steps of 1 meter, i.e. from the bottom of the hole, located about 9 m b.g.s., up to the capillary fringe, at about 3 m b.g.s.

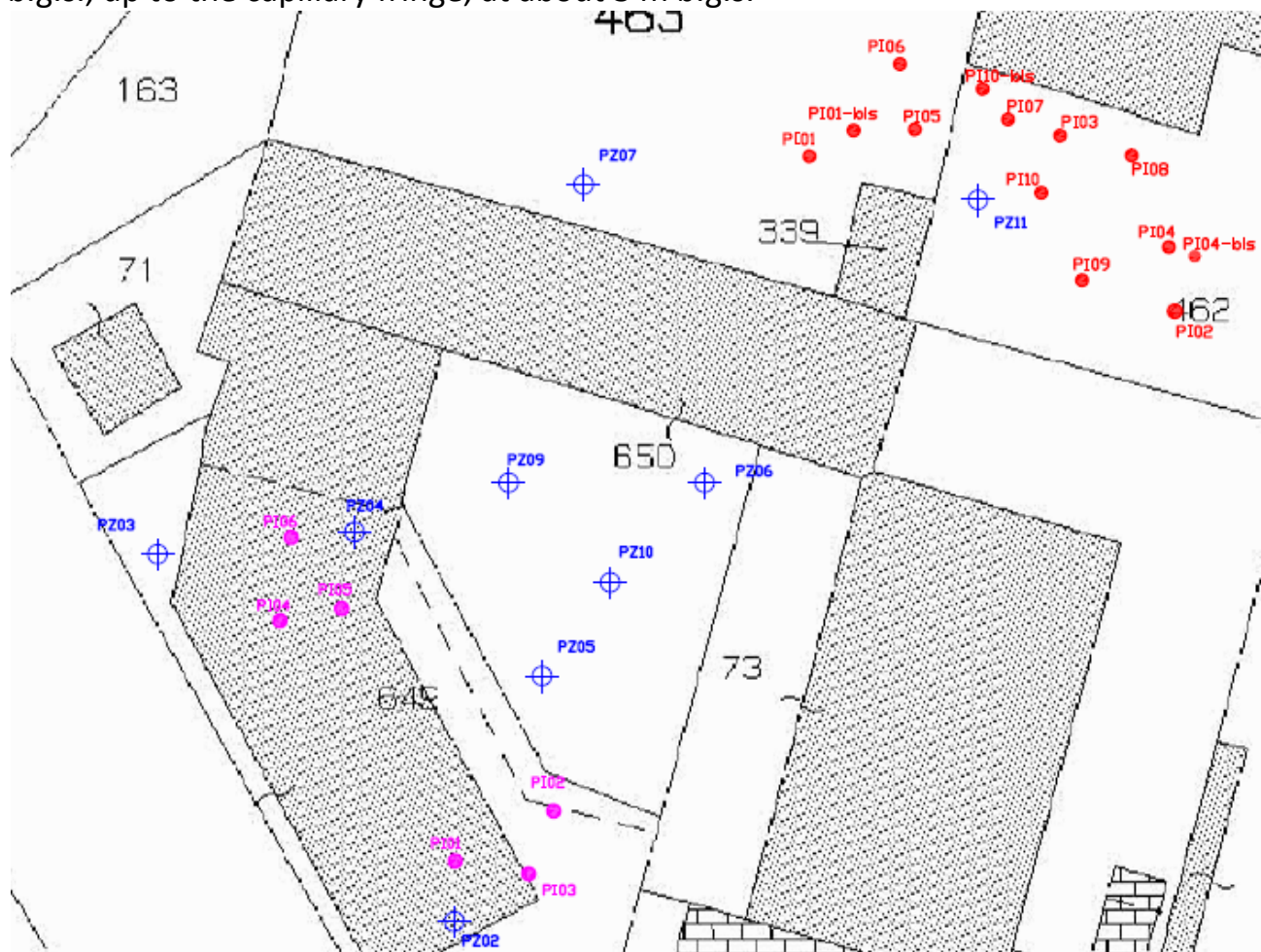

5.4 Radius of influence

Used the same interaxis of pilot scale.



5.5 Process and performance monitoring

The process monitoring of the second phase of remediation lasted more than 2 years. Here you may find the parameters, methods and frequencies.

Parameter	Method	Frequency
pH	Multiparameter probe	Twice a month for the first 2 months, then monthly
Temperature	Multiparameter probe	Twice a month for the first 2 months, then monthly
ORP	Multiparameter probe	Twice a month for the first 2 months, then monthly
DO	Multiparameter probe	Twice a month for the first 2 months, then monthly
Conductivity	Multiparameter probe	Twice a month for the first 2 months, then monthly
Groundwater level	Interface meter	Twice a month for the first 2 months, then monthly
BTEX, TPH, MTBE	Laboratory analysis	Twice a month for the first 2 months, then monthly

6. Post treatment and/or Long Term Monitoring

6.1 Post treatment and/or Long Term Monitoring

Post treatment and long term monitoring parameters are the same of the process and performance monitoring parameters. The results were periodically sent to local authorities described in technical reports. The persistence of MTBE in groundwater brought to the necessity of a third phase remediation plan.



7. Additional information

7.1 Lesson learnt

In the case study several challenges were encountered during the years. After the first phase of remediation, during which the LNAPL was recovered, the residual contamination, mainly MTBE in groundwater, was recalcitrant to the ISCO technology for several causes. Firstly, the remediation grid of injection points was located within the site property boundaries, because the surrounding private property did not allow the installation of any other remediation device. Secondly, the fine grained soil presumably in some case did not permit the reagents address properly the contamination.

7.2 Additional information

The keystone issue for a successful remediation is to gain a right conceptual site model, with a proper definition, in terms of extent, soil texture and presence of preferential flow pathways of the underground contamination source, in order to find adequate technology to properly address and remediate the CoCs.

7.3 Training need

E-learning/webinars in order to firstly understand the theoretical fundamentals of the technology (in terms of successful design and monitoring), but especially to be shown, through case studies, all the possible problems you can deal with during projecting, applying and monitoring the technology (lessons learnt by not perfect experiences).

Glossary of Terms

Term (alphabetical order)	Definition
BTEpX	Benzene, Toluene, Ethylbenzene, p-Xylene
LNAPL	Light Non-Aqueous Phase Liquid
MPVE	Multi Phase Vacuum Extraction
MTBE	Methyl tert-butyl ether
TPH	Total Petroleum Hydrocarbon
VOC	Volatile organic compounds (VOCs)

1. Contact details - CASE STUDY: ISCO n.3

1.1 Name and Surname	Simone Biemmi
1.2 Country/Jurisdiction	Italy
1.3 Organisation	Arcadis Italia s.r.l.
1.4 Position	
1.5 Duties	
1.6 Email address	Simone.biemmi@arcadis.com
1.7 Phone number	+39 338 783 33 25

2. Site background

2.1 History of the site: Challenges and Solution

The site is a divested fuel station located in a flat area of northern Italy. The activity of the site was in the distribution of petroleum products for transport with temporary storage of the substances inside underground tanks. Site was divested and tanks removed 2 years before remediation start.

ISCO technology has been evaluated as applicable to the site due to the medium-low lithology, and the type of groundwater contamination, difficult to treat with other systems.

In this context ISCO technology could reach remediation goals faster than other technologies.

2.2 Geological and hydrogeological setting

Site sub-soil consists of sandy filled soil from ground level to 3 m, then sandy-silt layer from 3 to 5 m and clayey-silt from 5 to 7m b.g.l. Groundwater depth is approximately 2.5 meters below ground surface in a medium-low permeability ($k = 1 \times 10^{-6}$ m/s) and low gradient.





2.3 Contaminants of concern

Groundwater samples indicated presence of Benzene (10 µg/L), Total Hydrocarbons (1,000 µg/L) and EtBE (1,000 µg/L) in internal area of the site, in tanks excavation area. Soil investigations after tank removal and excavation show no exceedance of regulatory limits, but the presence in saturated soil of ETBE (0.5 mg/Kg).

Remediation target for groundwater were defined with Sanitary and Environmental Risk Assessment. There are no remediation targets in internal area. At site boundary (POC's) is required to reach regulator limits for groundwater. In POC's PM2 and PM7 ETBE exceed the limit of 40 µg/L.

2.4 Regulatory framework

Remediation targets for groundwater were defined with Sanitary and Environmental Risk Assessment. There are no remediation targets in internal area. At site boundary (POC's) is required to reach regulator limits for groundwater. In POC's PM2 and PM7 ETBE exceed the limit of 40 µg/L.

The scope of remediation is to reach laws regulatory? limits in groundwater at POC's and decrease CoC concentrations in internal area in order to maintain POC's compliance.

ISCO Remediation strategy was detailed in a Remediation Design Document, approved by Regulators, that included preliminary laboratory test results.



3. Laboratory-scale application in field

3.1 Laboratory scale application

Laboratory batch tests were performed in order to evaluate:

- 1) Reagent effectiveness for ETBE concentrations decreasing
- 2) Potential for heavy metals mobilization

The test samples were prepared by mixing 100 g site soil, 500 mL groundwater with ETBE concentration of 1,000 $\mu\text{g/L}$ and 1.8 g of sodium persulfate and calcium peroxide mixture. Blank samples (100 g site soil, 500 mL groundwater with ETBE concentration of 1,000 $\mu\text{g/L}$) was prepared too.

Test results shows ETBE decreasing by 28% after 3 days, 57% after 7 days and 77% after 14 days.

CrVI (not detected in blank sample) increase to 26.8 $\mu\text{g/L}$ after 14 days. No potential for other metals mobilization was showed.



4. Pilot-scale application in field

4.1 Main treatment strategy

As described in literature, ISCO technology using persulfate activated by calcium peroxide is applicable at contamination detected in groundwater (at POC's ETBE, in internal area ETBE, Benzene and Hydrocarbons). Laboratory pilot test confirm good effectiveness of reagent for ETBE treatment.

Injections are compatible with the medium-low permeability (the mixture to inject is soluble) of the saturated matrix. Due to medium-low permeability it was decided to inject the reagent with tubes with valves (fixed manchette tubs) operating at high pressure.

Because the compliance of soil samples no other remediation and system was needed. Remediation strategy provides a first 6 month phase (pilot test) in internal area of site and a full-scale phase extended to POC's to be define after pilot test.

The product chosen for injection is a mixture with persulfate and an activator (calcium peroxide) that increase pH.

The mixture supports a two-fold mechanism for treating contaminants of concern. The reagent delivers one of the strongest chemical oxidants for short-term ISCO, and also provides electron acceptors (oxygen and sulphate) for longer-term biological oxidation. Persulfate is the strongest oxidant within the peroxides family, with an oxidation potential of 2.12 volts. As illustrated below, the direct oxidation half-cell reaction for persulfate involves a two-electron transfer: $2S_2O_8^{2-} + 2H^+ + 2e^- \rightarrow 2HSO_4^-$

However in most cases, rapid destruction of the contaminant of concern requires that the persulfate be activated in order to generate sulphate radicals.

Sulphate radicals are powerful oxidizing agents, with an oxidation potential of 2.6 volts. Activated persulfate is catalyzed with the peroxide and base provide by the calcium peroxide:

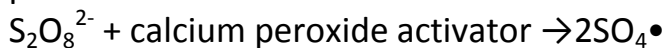

Activated persulfate can remain available in the subsurface for months providing a combination of power and stability.

The calcium peroxide provides several benefits. First, it imparts the alkalinity and peroxide needed to activate the persulfate using activation chemistry. Second, when mixed with water it provides a long-term, slow release source of hydrogen peroxide and calcium hydroxide.

The hydrogen peroxide that is slowly formed decomposes to oxygen and water, providing an extended oxygen source for subsequent bioremediation of petroleum hydrocarbons.



4.2 Additives

The approach used to activate the sulphate radical was elevating the pH, using calcium peroxide.

The calcium peroxide provides several benefits. First, it imparts the alkalinity and peroxide needed to activate the persulfate using activation chemistry. Second, when mixed with water it provides a long-term, slow release source of hydrogen peroxide and calcium hydroxide.

The hydrogen peroxide that is slowly formed decomposes to oxygen and water, providing an extended oxygen source for subsequent bioremediation of petroleum hydrocarbons.

4.3 Injection type

Injection was executed in internal area of the site in 2 tubes equipped by valves (fixed manchette tubs) between 2.5 (groundwater level) to 5 m b.g.l. in sandy-silt layer.

Injection points location was at different distance from monitoring wells (3m, 7m and 10m the nearest ones) in order to evaluate the ROI.

It was performed one injection of oxidant dosage of 175 Kg (20% water solution) for each point.

After 8 months monitoring would be start the full scale remediation.

4.4 Radius of influence

Radius of influence (ROI) provided for injection points: 3 meters. It was calculated on empirical methods



4.5 Control parameters

The measured parameters were pH, redox potential, temperature, dissolved O₂, electrical conductivity (field instrumentation) BTEX, total Hydrocarbons, ETBE, metals (Cr, Cr VI, As, Cd, Fe, Mn, Hg, Ni, Pb, Cu, Zn) and Sulphates.

Monitoring frequency:

- 1st week - all points chemical-physical parameters (with field instrumentation)
- 2nd week - all points chemical-physical parameters
- after 1 month – all points groundwater analysis and chemical-physical parameters
- after 2 months - all points groundwater analysis and chemical-physical parameters
- after 4 months – all points groundwater analysis and chemical-physical parameters
- after 6 months - all points groundwater analysis and chemical-physical parameters

5. Full-scale application

5.1 Main Reagent

With respect to the pilot test it was confirmed the reagent (mixture of sodium persulfate auto activated with calcium peroxide). The dosage was confirmed in internal area and reduced by 40% near site boundaries in order to limit temporary effects of CrVI mobilization.

5.2 Additives

No changes from pilot to full scale application.



5.3 Injection type

1 injection campaign was performed in tubes equipped by valves between 2.5 (groundwater level) to 5 m b.g.l. in sandy-silt layer (like pilot test).

Basing on pilot test results full scale was performed using a triangular injection grid, with 4.5 m spacing. (21 injection points in a 450 m² area). Oxidant dosage of 175 Kg (20% water solution) for each point in internal area. Dosage was reduced by 40% for each of 6 injection point near site boundary.

5.4 Radius of influence

Radius of influence was calculated considering at what distance the monitoring wells were interested by injection effects during field pilot test. Pilot test ROI = 3m was confirmed.

5.5 Process and performance monitoring

The process monitoring is provided for 1 year.

The measured parameters are the same of pilot test: pH, redox potential, temperature, dissolved O₂, electrical conductivity (field instrumentation) BTEX, total Hydrocarbons, ETBE, metals (Cr, Cr VI, As, Cd, Fe, Mn, Hg, Ni, Pb, Cu, Zn) and Sulphates.

Monitoring frequency:

- 1st week - all points chemical-physical parameters (with field instrumentation)
- 2nd week - all points chemical-physical parameters
- after 1 month – all points GW analysis and chemical-physical parameters
- after 2 months - all points GW analysis and chemical-physical parameters
- after 4 months – all points GW analysis and chemical-physical parameters
- after 6 months - all points GW analysis and chemical-physical parameters
- after 8 months – all points GW analysis and chemical-physical parameters
- after 10 months - all points GW analysis and chemical-physical parameters
- after 12 months - all points GW analysis and chemical-physical parameters



6. Post treatment and/or Long Term Monitoring

6.1 Post treatment and/or Long Term Monitoring

No long term monitoring is provided after monitoring plan described at 5.5.

7. Additional information

7.1 Lesson learnt

Monitoring of injection treatment show in field pilot test a first temporary phase (1 months) of CoC desorption from saturated soil and CrVI mobilization in groundwater (2-6 months) due to pH and redox increase. After that both CoC decrease and reach remediation goal and CrVI return to pre-injection level.

It was possible to define these effects both spatially and temporally due to the presence of a dense network of monitoring wells and frequent control campaigns.

The experience gained during pilot test was fundamental for the design of the full scale phase. Due to the precise technical information described, Regulators have approved the full-scale remediation without any prescription.

7.2 Additional information

The injection points and monitoring wells were drilled with continuous core drilling. It can allow to verify in the field the presence of layer with higher contamination, and for consequence is possible to evaluate increasing oxidant dosage in these levels.

Glossary of Terms

Term (alphabetical order)	Definition
CoC	Contaminant of Concern
ROI	Radius of influence

1. Contact details - CASE STUDY: ISCO n.4

1.1 Name and Surname	Peter Freitag
1.2 Country/Jurisdiction	Austria
1.3 Organisation	Keller Grundbau Ges.mbH
1.4 Position	Lead of “Environmental Geotechnics” working group
1.5 Duties	Consulting, planning and execution of remediation projects
1.6 Email address	Peter.Freitag@keller.com
1.7 Phone number	+43 664 6144014



2. Site background

2.1 History of the site: Challenges and Solution

The site is located at the heart of Graz, Styria. From 1946 onward the area had various usages (Dyeing workshop, benzene laundry). Starting in 1958 Tetrachlorethylene was used in chemical laundry on site. For various reasons this TCE intruded into the subsoil, causing contamination on the site and neighbouring public space.

The planned remediation scheme consisted of an excavation with offsite treatment and horizontal well systems to treat contaminated groundwater in public space. After the remediation a residential building is planned.

The lateral support and the remediation of a contaminated subsoil zone below an existing building proved to be challenging. The first mainly due to constraints on available space, making the usage of larger drilling rigs for bored piles impossible. The later because excavation was not possible. HaloCrete® (HC) – an adaption of the jet grouting*1 technique for in situ remediation – was used as a solution to both problems.

*1 Jet grouting is a technique where a high-pressure jet – originating perpendicular from a rotating drilling rod - erodes soil material. The jet normally consists of a cement/water slurry. During retraction of the drilling rod this leads to the formation of columns in the subsoil. Working parameters are defined to securely achieve pre-defined diameters.

Normally this technique is used for underpinning or lateral support works in geotechnics.

2.2 Geological and hydrogeological setting

The geological situation can be described (simplified) in the following way: Manmade fills of various thickness (~3m) lie over a horizon of fine sands. Below that, the aquifer consisted of sandy, silty gravels. At approx. 7m bgl silts constitute the aquiclude.

Groundwater table can be found at around 6m bgl, with a gradient of 0,8%. Permeability was estimated to be around 5×10^{-4} m/s for the gravels.



2.3 Contaminants of concern

Tetrachlorethylene was found to be the main contaminant. Concentration data was given by the environmental planner, with highest concentrations of 14000 mg/m³ found below the installation site of the washing machines.

Residual PCE in phase was deemed possible.

Most of the ISCO measures were conducted in a zone of approx. 3000 mg/m³

2.4 Regulatory framework

No special approval was needed.

As the ISCO operation was only a comparatively small part of the remediation no special target values were given. Lacking exact (on spot), in-situ measured concentrations it was agreed to analyse the columns for their content of TCE and compare it with estimated concentrations.

I'm not aware of the specific regulatory framework in place (federal country ("Bundesland") specific) and defined target values. These topics were taken care of by the overall planner.



3. Laboratory-scale application in field

3.1 Laboratory scale application

Due to time constraints – we've only been involved late in the project – we could only conduct batch tests together with our partners from the AIT (Austrian Institute of Technology).

We analysed for NOD of soil as well as two prospective geotechnical binders (ordinary Portland cements) needed for statical reasons. The soil samples were taken from different depth levels.

As oxidizing agents KMnO_4 and NaMnO_4 were tested, mainly for handling considerations (powder vs. liquid). Hereby no significant difference was observed after 24h. These tests were conducted on simulated column material, i.e. contaminated (site) soil samples + cement + oxidising agent

A target concentration of $20\text{gKMnO}_4/\text{kg}$ column was recommended. This was based on the assumption of residual phase on site. In later discussions with the planner this value was reduced taking into considerations local variances and homogenization effects during the jet grouting process.

4. Pilot-scale application in field

4.1 Main treatment strategy

For this project no pilot-scale application was conducted. The feasibility of jet grouting had been proven in a research project ("HaloCrete" partly funded by the Austrian authorities)

HaloCrete was selected because it solved both structural (lateral support of excavation) and remediation (below buildings) challenges. KMnO_4 was then selected because it can be easily introduced into the overall jet grouting process. It was added at the mixing plant for the cement slurry in granular form. From there operations were conducted as usual.

The only difference to standard applications was the accumulation of two different backflow slurries. One being from uncontaminated soil zones and the other from contaminated zones containing KMnO_4 .

Works were planned to be finished after four weeks.

5. Full-scale application

5.1 Main Reagent

KMnO_4 , no changes to lab test

5.3 Injection type



A plan view of the site. Bright red indicates sources of contamination (sewer, washing machines), red and yellow circles are planned HaloCrete columns. Column spacing was 1.2m to secure statical required overlapping, column diameter 1.5m. Drilling depths of up to 9m bgl



A picture of the site. Works are conducted below former washing machines. Backflow deeply covered purple by KMnO_4

5.4 Radius of influence

Due to the jet grouting installation process, the radius was “pre-defined” and measured/controlled in-situ.



5.5 Process and performance monitoring

Apart from standard quality assurance (for jet grouting applications) no additional controls were required.

Control and monitoring of chemical parameters were not in the scope of Kellers work. The final proof of success on ISCO works was a direct TCE-concentration measurement on samples taken from core drillings at different depths.

7.3 Training need

This relatively new approach of using jet grouting as a means of delivery for ISCO reagents must be made more public in general.

Taking various boundary conditions into consideration it can be a feasible and economic approach for in-situ remediation.

What comes to mind are otherwise deep excavations in need of lateral support, source zones difficult to address with conventional injection techniques and synergistic effects with construction requirements. HaloCrete columns can be used statically like any other jet grouting body.

7.4 Additional remarks

I'm aware that this project differs widely from "ordinary" ISCO project, especially as ISCO was only part of a combined solution. Insofar I couldn't give an answer to every question in this survey as not all of them are applicable to our approach.

Nonetheless I hope that this contribution widens the perspective on techniques and possibilities already available for ISCO (or ISCR) applications.

Glossary of Terms

Term (alphabetical order)	Definition
m bgl	m below ground level

1. Contact details - CASE STUDY: ISCO n.5

1.1 Name and Surname	Mara Dal Santo
1.2 Country/Jurisdiction	Italy
1.3 Organisation	Stantec
1.4 Position	Senior Technical Specialist
1.5 Duties	Environmental consultant
1.6 Email address	mara.dalsanto@stantec.com
1.7 Phone number	



2. Site background

2.1 History of the site: Challenges and Solution

The site was a fuel retail site until 2015, its area is 1500 m² and it is located at 20 m above sea level in Northern Italy. Since 2015 it has been a parking area. MTBE contamination was detected during the preliminary environmental investigation carried out in order to prepare the complete demolition of the plant. It was hypothesized an oil leakage from tanks and/or from lines during the selling activities. ISCO technology was selected in order to manage the residual contamination. At first, in fact, the contamination was treated with EAB filter socks as emergency measures and with EAB product injection as per RAP. The planned RAP second injection was made with ISCO and not with EAB product, as assumed before, just to obtain a more effective contamination reduction and to close the environmental case. ISCO technology was selected in order to remediate groundwater and facing the difficulty in reaching the tight legislative target of 40 µg/l for MTBE.

2.2 Geological and hydrogeological setting

The site is characterized by alluvial plain sedimentation: silty-sand (see below “sabbia”) with clay-silt lenses, 0.5 to 1 m thick (see below “limo” and “argilla”). The groundwater level varies from 0.80 to 1.5 m bgl. The maximum depth reached by the drilling is 6.5 m bgl.

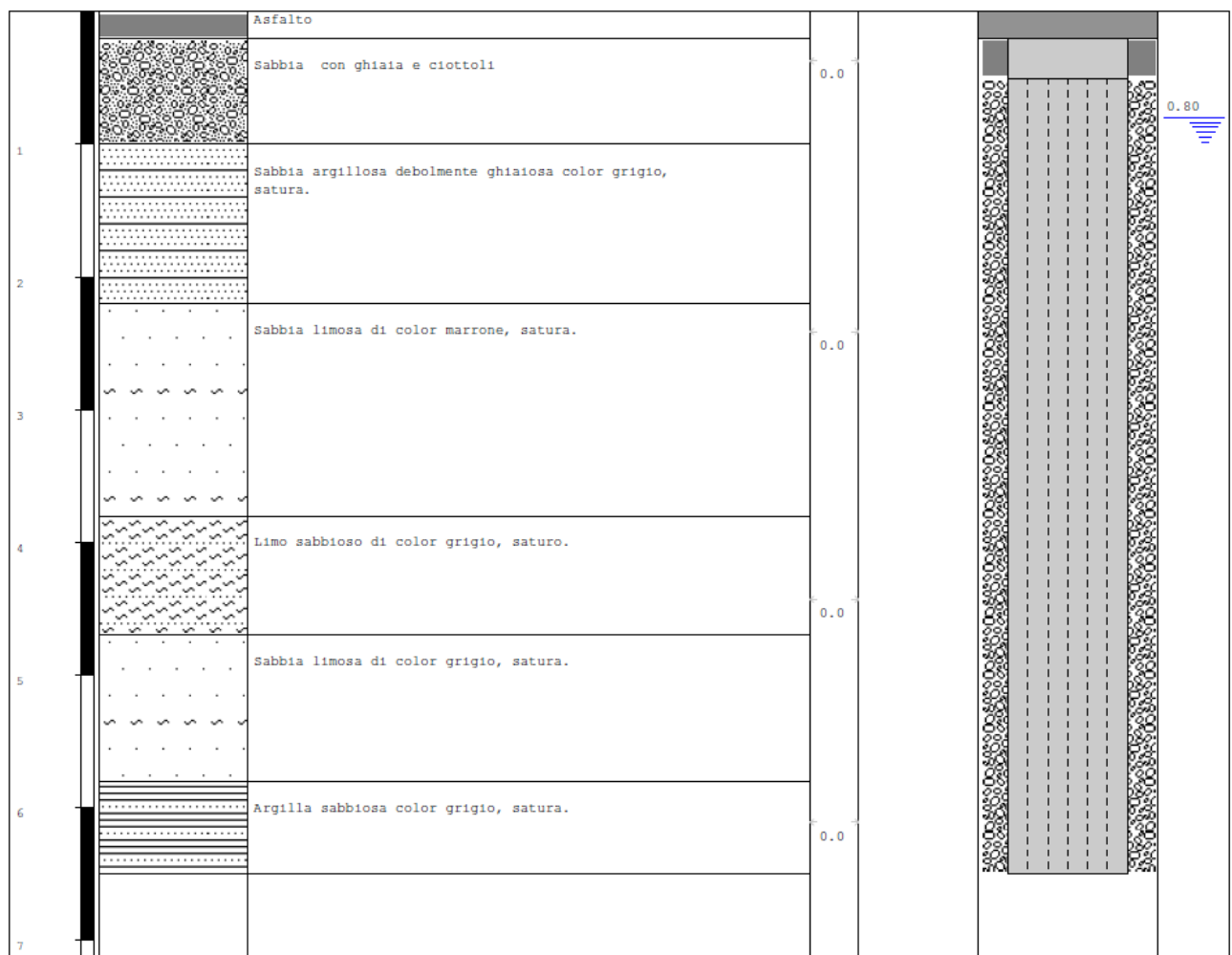

The local groundwater flow direction is W-E, the gradient 0.01, the hydraulic conductivity is medium (about 10^{-5} m/s. This value is just an estimate, hydraulic tests were not performed)

2.3 Contaminants of concern

The maximum concentration measured during the planned monitoring for groundwater and for soil are displayed in the following table. These concentrations have been used as input parameters for the remediation design

CONTAMINANTS OF CONCERN (COCs)		
Constituent	GW (mg/L)	Soil (mg/kg)
MTBE	1.45	0.087
DRO	1	43.25

According to the historical data set, there are three monitoring wells with exceedances, all the other have total hydrocarbon and MTBE under the law limits. Here below the concentrations measured in the period from 2016 to 2017.

Denominazione		28/07/2016	14/11/2016	23/12/2016	30/01/2017	23/02/2017	06/04/2017	23/05/2017	DLgs 152/06 All 5 Tab 2
Parametro	U. M.								
Piombo	µg/L	< 0,1							0,1
COMPOSTI ORGANICI AROMATICI									
Benzene	µg/L	< 0,1	< 0,1	< 0,1	< 0,1	< 0,1	< 0,1	< 0,1	1
Etilbenzene	µg/L	< 1	< 1	< 1	< 1	< 1	< 1	< 1	50
Stirene	µg/L	< 1	< 1	< 1	< 1	< 1	< 1	< 1	25
Toluene	µg/L	< 1	< 1	< 1	< 1	< 1	< 1	< 1	15
p-Xilene	µg/L	< 1	< 1	< 1	94	< 1	< 1	< 1	10
ALTRE SOSTANZE									
Idrocarburi totali (n-esano)	µg/L	171	101	39	1068	30	43	42	350
MTBE (Metilterzbutiletere)	µg/L	172	52,5	159	154	72,7	73,6	83,6	40*
ETBE (Etilterzbutiletere)	µg/L	-	8,1	6	13,3	3,8	8,7	5,9	40*
Piombo tetraetile	µg/L	< 0,01	< 0,01	< 0,01	< 0,01	< 0,01	< 0,01	< 0,01	0,1*

Denominazione		05/08/2016	14/11/2016	23/12/2016	30/01/2017	23/02/2017	06/04/2017	23/05/2017
Parametro	U. M.							
Piombo	µg/L							
COMPOSTI ORGANICI AROMATICI								
Benzene	µg/L	< 0,1	< 0,1	< 0,1	< 0,1	< 0,1	< 0,1	< 0,1
Etilbenzene	µg/L	< 1	< 1	< 1	< 1	< 1	< 1	< 1
Stirene	µg/L	< 1	< 1	< 1	< 1	< 1	< 1	< 1
Toluene	µg/L	< 1	< 1	< 1	< 1	< 1	< 1	< 1
p-Xilene	µg/L	< 1	< 1	< 1	< 1	< 1	< 1	< 1
ALTRE SOSTANZE								
Idrocarburi totali (n-esano)	µg/L	< 30	43	45	< 30	< 30	< 30	< 30
MTBE (Metilterzbutiletere)	µg/L	1057	375	516	294	1310	33	1195
ETBE (Etilterzbutiletere)	µg/L	-	9,6	9,2	14	31,1	10,5	13,1
Piombo tetraetile	µg/L	< 0,01	< 0,01	< 0,01	< 0,01	< 0,01	< 0,01	< 0,01



Denominazione		28/07/2016	14/11/2016	23/12/2016	30/01/2017	23/02/2017	06/04/2017	23/05/2017
Parametro	U. M.							
Piombo	µg/L	< 0.1						
COMPOSTI ORGANICI AROMATICI								
Benzene	µg/L	< 0,1	< 0,1	< 0,1	< 0,1	< 0,1	< 0,1	< 0,1
Etilbenzene	µg/L	< 1	< 1	< 1	< 1	< 1	< 1	< 1
Stirene	µg/L	< 1	< 1	< 1	< 1	< 1	< 1	< 1
Toluene	µg/L	< 1	< 1	< 1	< 1	< 1	< 1	< 1
p-Xilene	µg/L	< 1	< 1	< 1	< 1	< 1	< 1	< 1
ALTRE SOSTANZE								
Idrocarburi totali (n-esano)	µg/L	< 30	< 30	50	< 30	< 30	< 30	< 30
MTBE (Metilterzbutiletere)	µg/L	80.6	48.8	18.4	< 0,5	< 0,5	32.1	80.7
ETBE (Etilterzbutiletere)	µg/L	-	4.9	1.5	3.5	2.6	2.6	6.6
Piombo tetraetile	µg/L	< 0,01	< 0,01	< 0,01	< 0,01	< 0,01	< 0,01	< 0,01

The clean-up goals are 40 µg/l for MTBE and 350 µg/l for total hydrocarbon expressed as n-hexane into groundwater.

2.4 Regulatory framework

In Italy, according to the D.Lgs 152/06 and DM 31/15, when a potential contamination is assumed or detected the site becomes a contaminated site and the owner or the “involved subject” has to inform the public authorities. The site must be characterized in order to define the conceptual model of the contamination. Then a risk analysis could be carried out in order to define site specific concentration limits. If the concentrations are above the concentration limits, defined by law or by site specific analyses, the site has to undergo a remediation.

In order to apply a chemical product in the ground the Public Authorities have to approve the Remedial Action Plan. In the case shown here the Authorities also allow to put filter socks as “emergency plan” stage and not as RAP, is it not common in all the Italian territories. Most regions allow the use of chemical compounds only under a RAP approval.

Here below the site history of the site related to the regulatory framework.

- May, 2015: execution of the preliminary investigation for the decommissioning of the fuel retail station
- June, 2015: transmission of the notification according to D.Lgs.152/06 and D.M. 31/15;
- July, 2015: decommissioning of the plant and starting of emergency activities (removal of the portion of soil surrounding the removed tanks, purging of water from the excavation and soil sampling from the walls and bottom of the



excavations);

- November, 2016: installation of socks for EAB
- April, 2017: replacement of socks for EAB
- July, 2017: RAP transmission
- December, 2017: PA approval of RAP.
- April, 2018: EAB product injection
- April, 2019: ISCO injection
- January, 2020: first of 4 planned quarterly groundwater sampling tested with PA in order to define the groundwater not contaminated
- June, 2020: groundwater sampling tested with PA
- September, 2020: groundwater sampling tested with PA
- November, 2020: groundwater sampling tested with PA
- December, 2020: execution of soil testing surveys in order to define the soil as not contaminated soil for all the site.

3. Laboratory-scale application in field

3.1 Laboratory scale application

No laboratory scale application was done. The oxidant demand was calculated from site condition parameters such as lithology, contaminant concentrations, fraction of organic carbon, hydraulic conductivity, volumes of groundwater and soil to be treated. The calculation was made with a stoichiometric approach.

4. Pilot-scale application in field

4.1 Main treatment strategy

The RAP considered two injection campaigns: the first was carried out with EAB product, the second with ISCO product. No pilot test was conducted onsite considering the very small area of the contaminated site (1500 m²). The second injection was sized based on the result of the first injection activity.



5. Full-scale application

5.1 Main Reagent

- The first treatment application started in April 2018 and consisted of the injection of EAB product through 8 direct push points. The selected product is a specially formulated time-released grade of calcium peroxide designed to assist in the aerobic bioremediation in soil and groundwater. A volume of 600 liter of slurry, prepared with water in a concentration of 25%, was injected into the subsurface through each direct push point. Totally, 1200 kg of dry powder of product were used.
- The second treatment application started in July 2019 and consisted of the injection of ISCO product through 8 direct push points. The selected product is a single, formulated product consisting of high pH-activated persulfate and calcium peroxide. A volume of 600 liter of slurry, prepared with water in a concentration of 25% was injected in the subsurface through each direct push point. Totally, 1800 kg of dry powder of the selected product were used.
- The amount of applied reagent was calculated based on a stoichiometric approach

5.2 Additives

The ISCO selected product is formulated to provide a self-activated persulfate oxidation system, therefore no additives were used beside the main reagent.

5.3 Injection type

Eight direct-push injection points to treat from 1 to 6 m bgl. The injection was done from top to down for each 0.5 m interval. In some intervals, it was difficult to inject all the reagent as planned, so the string was shifted to just below the interval in order to complete the injection.

5.4 Radius of influence

The radius of influence was estimated to be not less than 2 m, based on lithologies and injection method.

5.5 Process and performance monitoring

- Monthly monitoring for the first 3 months: MTBE (lab analysis) and chemical-physical parameters (measured onsite);
- Quarterly monitoring with extended analytical set: Total hydrocarbons, Benzene, Ethylbenzene, Toluene, Xylenes, MTBE, ETBE (lab analysis) and chemical-physical parameters (measured onsite).
- In the graph below there are the evolution of MTBE concentration during time. The two red arrows indicate the first EAB injection carried out on April 2018 and the second ISCO injection carried out on July 2019

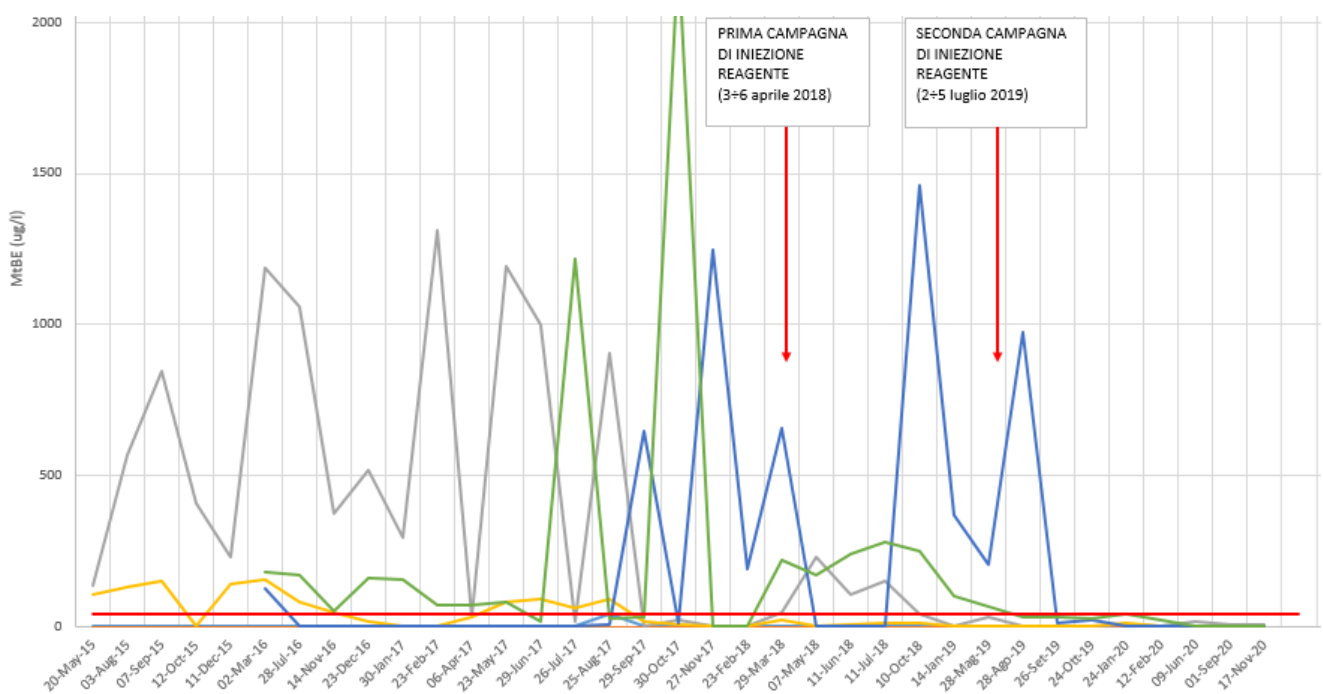



6. Post treatment and/or Long Term Monitoring

6.1 Post treatment and/or Long Term Monitoring

After 1 year from the ISCO injection job: quarterly monitoring with extended analytical set: Total hydrocarbons, Benzene, Ethylbenzene, Toluene, Xylenes, MTBE, ETBE (lab analysis) and chemical-physical parameters (measured onsite). After 4 monitoring campaigns without exceedances it will be possible to close the environmental case. (these conditions are case-specific and defined by the PA)

7. Additional information

7.1 Lesson learnt

The case study can be defined as a case of success since the goal of reducing the contamination below the threshold limits has been achieved and it will soon be possible to request closure of the environmental case. However, it is possible to make some considerations. The sending of the RAP to the authorities could have been done more quickly but, above all, the choice of an ISCO+EAB products since the first injection would have potentially allowed compliance to be achieved more quickly. This hypothesis could have been verified by laboratory or field tests.

7.2 Additional information

Given the modest size of the site and the concentrations of contaminants, the choice to implement the remediation by injection of reagents has been successfully performed in a relatively short time and has been shown to be relatively sustainable.

7.3 Training need

- It would be useful to have an e-learning training on these aspects: proper design of the remediation; use of laboratory and field tests and use of indicators to verify the progress of the remediation (taking into account not only chemical analysis).
- In addition, it may be useful to analyze and discuss case studies through workshops.



- It would be useful if this training were not provided only by reagent producers, even though they have produced a great deal of research and studies in the field, but rather by a synergic team containing various interests: the need to improve remediation products, to remediate effectively and quickly, and to be able to propose remediation that is effectively and well accepted by the PA.

7.4 Additional remarks

Really consider reagent injections remediation technology as a robust alternative to remediation plant technologies.

Glossary of Terms

Term (alphabetical order)	Definition
EAB	Enhanced Aerobic Bioremediation
PA	Public Authority
RAP	Remedial Action Plan according to the Italian law "Progetto Operativo di Bonifica - POB"

1. Contact details - CASE STUDY: ISCO n.6

1.1 Name and Surname	¹ Gordon H. Bures ² Alberto Leombruni ³ Mike Mueller
1.2 Country/Jurisdiction	¹ Germany ² Italy ³ Austria
1.3 Organisation	¹ Sensatec GmbH ² Evonik ³ Evonik
1.4 Position	¹ Technical lead – environmental fracturing ² Authorized technical representative Italy and Spain ³ Business Development Manager EMEA
1.5 Duties	¹ Project engineer for the design and implementation of innovative, <i>in situ</i> remediation techniques and enhancement technologies ² Responsible for high-level collaboration with environmental consultants, engineers, impacted site owners, regulators and the academic community ³ Manager of the Soil & Groundwater Remediation Technologies department as Business Development Manager (EMEA) at Evonik Active Oxygens. Based in Austria, responsible for high-level collaboration with environmental consultants, engineers, site owners, regulators and the academic community.
1.6 Email address	g.bures@sensatec.de alberto.leombruni @dgextern.com mike.mueller@evonik.com
1.7 Phone number	¹ +49 (0)176 1389 0095 ² +39 3895121600 ³ +43 6641803060

2. Site background

2.1 History of the site: Challenges and Solution

The subject site is situated near Frankfurt am Main, Germany on the grounds of a former chemical manufacturing facility which produced solvents for metalwork, cleaning chemicals, and specialty oils. Other facilities of environmental concern on the property included a former oils and chemicals storage building, as well as an underground storage tank and pipeline for the storage of industrial solvents.

The plant was in operation from the mid- 1960s until a fire destroyed it, causing the plant to cease operations in 1974. It is suspected that the fire and resulting explosion was a major factor in the release of contaminants to the subsurface environment. The property was subsequently acquired in 1985 by new owners who used the site for manufacture of industrial presses until 2014. Since then, the property is used for general warehouse storage, parking lot, and auto mechanic shop.



Site of former chemical manufacturing facility in Hessen, Germany

Significant challenges to the implementation of remedial measures at the site were the massive impacts of co-mingled contaminants of concern to underlying soils and groundwater including

- Chlorinated aliphatic hydrocarbons, primarily cis-Dichloroethylene (cDCE)
- Aromatic petroleum hydrocarbons (BTEX), including trimethylbenzene (TMB)
- Aliphatic total petroleum hydrocarbons (TPH)
- Trace amounts of polycyclic aromatic hydrocarbons (PAHs)
- Free- phase oil at one location

Other challenges at the site included:



- Deep contaminant impacts
- Site constraints: nearby plant buildings; underground tank and pipeline facilities; small stream downgradient of contamination (within 50 m)
- Unfavourable geology for conventional in situ remedial technologies
- Need for developing feasible site- specific remediation criteria
- Negotiated allocation of clean up costs among responsible parties
- Remedial costs

A technology was sought by the site owner and environmental consultant which could cost-effectively mitigate subsurface contamination within the site- specific constraints and limitations mentioned herein.

2.2 Geological and hydrogeological setting

The area of investigation consists of a surface layer of concrete which is underlain by gravel and sand fill to a depth of 1,3 m below the ground surface (bgs). Underlying the fill soils are quarternary deposits of gravel and sand colluvium of variable thickness, interbedded with sand and clay layers. Silty clays are encountered below the colluviums between depths of 3,6 to 8,3 m bgs which forms a hydraulic boundary between the overlying quarternary colluvial aquifer and an underlying tertiary (drinking water) aquifer comprising fine to medium sands. The depth to groundwater ranges from 2 to 3 m bgs.

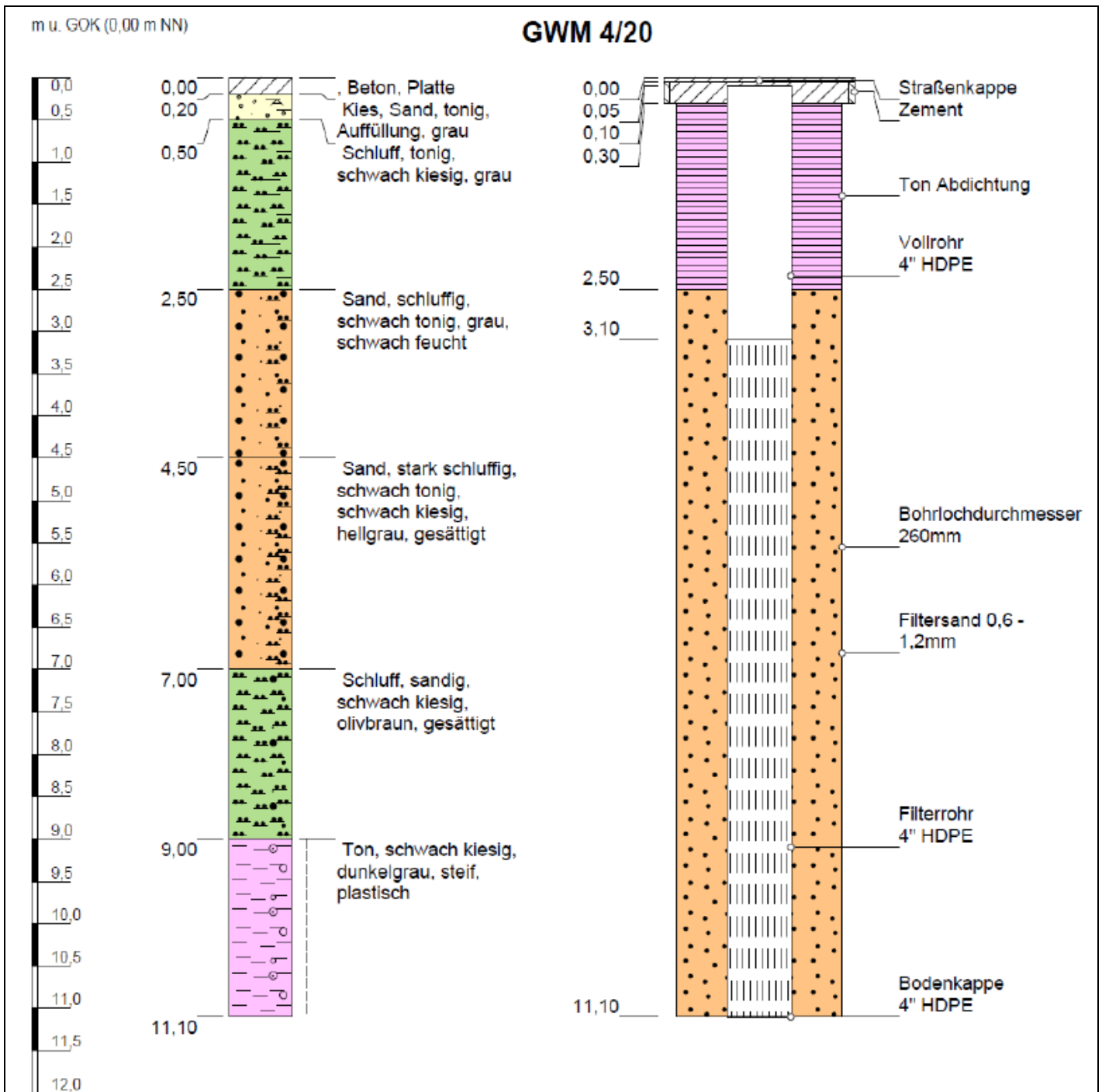

The results of pump testing conducted over 72 hours in the upper aquifer sediments determined an average hydraulic conductivity of 1.3×10^{-6} m/s indicating an aquifer of marginal yield (2L/min), due to the presence of significant silt and clay fines within the aquifer matrix. The direction of groundwater flow is to the south-southwest with a hydraulic gradient of approximately 5%.

2.3 Contaminants of concern



Legende

- Direct Push-Sondierung (DP)
- EC- und GW-Sondierung
 - GW-Sondierung

n.n. nicht nachweisbar
 -- keine Probenahme möglich

Gehalte LHKW in µg/l
0 - 100
101 - 500
501 - 1.000
1.001 - 10.000
> 10.000



Distribution of CHC concentrations in Groundwater



A total of 6 subsurface investigations were conducted between 1999 and 2017 in an effort to delineate and quantify the distribution of contaminants underlying the site. The results of these investigations determined that petroleum hydrocarbon contamination (TPH and BTEX impacts) were largely confined within soils in the unsaturated zone with contaminant concentrations upwards to 5,000 mg/kg and 344 mg/kg respectively. Dissolved-phase contaminant impacts to groundwater within the quaternary aquifer consisted primarily of total chlorinated aliphatic hydrocarbons (CHCs) of upwards to 44,300 µg/L, followed by TPH (2,000 µg/L) and BTEX (1,800 µg/L).

The major component of CHC contamination was cis-1,2 DCE (54%), followed by tetrachlorethylene ("PCE" 28%), and trichloroethylene ("TCE" 16%). The major component of BTEX contamination was trimethylbenzene (TMB >76%) followed by xylenes.

Free-phase oil product was detected at one monitoring well location with an apparent thickness of a few cm.

Calculations to estimate the mass of contaminants present within the quaternary aquifer indicated a total of approximately 3.7 kg of dissolved phase CHCs and 8.7 kg of sorbed phase CHCs respectively. The estimated total of BTEX and TPH contaminants (dissolved and sorbed) was approximately 2.5 kg. Applicable groundwater regulatory limits for contaminants of concern found in groundwater at the site are summarized below:

- CHCs: 20 µg/L
- VC: 0.5 µg/L
- BTEX: 20 µg/L
- TMB: 1 µg/L
- TPHs: 100 µg/L

The delineation of the various contaminants of concern was achieved using a combination of soil probe borings, drilling and sampling of groundwater monitoring wells, and through the use of innovative Direct Push technologies using Geoprobe® drilling equipment and specialized sampling technology such as Membrane Interface Probe (MIP), Screen Point groundwater sampling, and Electrical Conductivity (EC) downhole tools.



2.4 Regulatory framework

Based upon the results of subsurface contamination quantified at the site, the regional environmental regulatory authority ordered that soil and groundwater remediation efforts be implemented at the site to mitigate contaminant impacts on potential environmental receptors. The specific goal of the regulatory clean up order was to “prevent the danger of contaminant exposure to receptors and prevent the long term spreading of contaminants”. In order to achieve this goal, the regulation requires that “applicable remedial measures be applied to minimize or remove contaminants (i.e decontamination) and to prevent or minimize the spread of contaminants i.e. (containment)”.

A Remediation Action Plan was subsequently requested by the authority to comply with the above mentioned regulatory requirements. The remedial plan submitted to the authority proposed remediation of the heavily impacted unsaturated zone soils by excavation and disposal, resulting in the removal of approximately 300 m³ of contaminated soil to a depth of 2 m to 3m bgs. This remedial measure was implemented concurrently with the decommissioning and removal of the existing oil and chemical storage building on the property. There were no specific contaminant clean up criteria for soil quality required for the excavation of impacted surface soils.

For the remediation of dissolved phase contaminants in the unsaturated zone, a feasibility study for the implementation of in situ chemical oxidation (ISCO) and in situ bioremediation (ISBR) was proposed as possible cost-effective and sustainable remediation alternatives to conventional excavation/disposal and large diameter soil replacement borings that were being considered. The results of the study determined that ISCO was a viable approach, although its effectiveness for practical purposes could be severely limited based upon the low hydraulic conductivity of the saturated zone sediments. To overcome this limitation, the authority approved the application of “environmental fracturing” using Targeted Solids Emplacement (TSE[®]) technology by Sensatec GmbH as the preferred means of distributing solid-phase oxidants as slurry into the impacted aquifer sediments.

Risk-based remediation criteria were developed for CHC contaminants at the site whereby a reduction of total CHC concentrations (i.e for PCE, TCE, DCE and VC) of 95% over 3 consecutive monitoring events in source area monitoring wells was required.



3. Laboratory-scale application in field

3.1 Laboratory scale application

A laboratory feasibility study was conducted by Sensatec GmbH at its facilities in Kiel, Germany, to compare the efficacy of ISCO and aerobic/anaerobic ISBR to degrade concentrations of total CHC and BTEX contaminants in soil and groundwater samples obtained from the site.

The scope of the laboratory work consisted of:

ISCO:

- Characterization of ISCO relevant parameters TIC, TOC, metals, pH and EC;
- Determination of Soil Oxidant Demand;
- Determination of reaction kinetics and oxidant demand;

ISBR:

- Determination of site-specific micro-biological nutrient deficiencies and requirements (N,P,K,S,C);
- Conducting substrate induction tests to identify cosubstrate utilization profiles for various carbon based substrates at differing concentrations;
- Contaminant degradation testing using 5 varieties of substrates to enhance anaerobic and aerobic attenuation rates.

The results of laboratory analyses for ISCO determined that the impacted sediments contained very little natural organic matter ($foc = < 0,001$) compared to inorganic carbon ($0,0038$ g/g) due to high levels of oxidizable iron. The corresponding soil oxidant demand was determined by 96 hour batch testing to be 14 g oxidant/kg soil matrix which is classified as low oxidant demand (Oppermann, 2013), thereby indicating that ISCO was a viable remedial option for the site.

Of the three candidate oxidants considered in the laboratory feasibility analysis, potassium permanganate and activated persulfate oxidants showed the greatest destruction efficiency (contaminant mass removal/oxidant consumption) of CHC and BTEX contaminants compared to Fentons reagent, which exhibited the greatest oxidant consumption and shortest longevity (94% reduction within 48 hrs). The results demonstrated that Fentons Reagent was a less efficient oxidant compared to permanganate or persulfate (comparitive efficiency of 25%) due to its non-selective oxidation of metals and NOM, and fast kinetics, which result in the rapid depletion of oxidation potential and short remedial duration. Fentons reagent also exhibited the largest decrease in pH over the course of the test (from 7,1 to 2,7), whereas potassium permanganate exhibited the slightest decline (from 7,1 to 6,6) and returned to its pre-

test value after 96 hours.

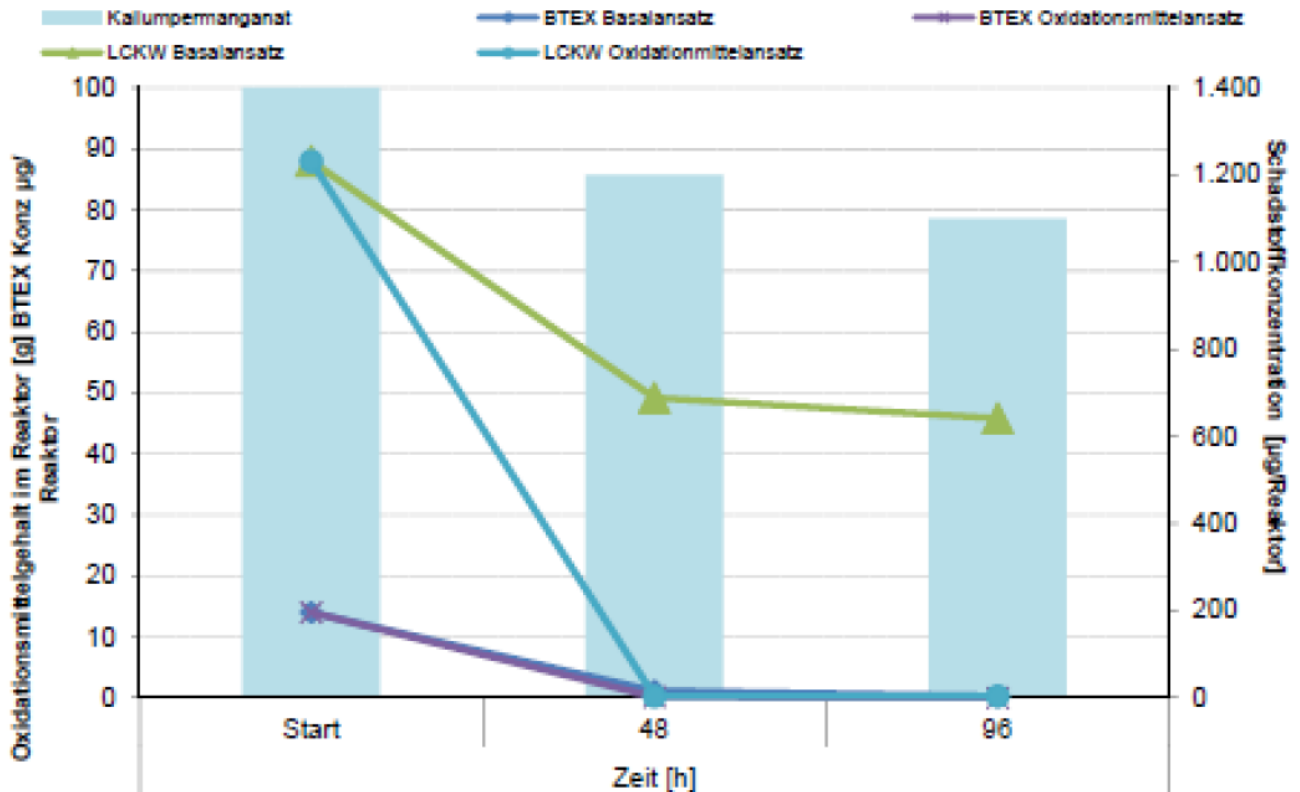

Oxidant consumption (KMnO_4) and contaminant reduction (CHC and BTEX) during 96 hr reactor test

The results of laboratory analyses for ISBR determined that nutrient addition to site groundwater samples did not appreciably increase aerobic respiration rates, thereby indicating that there were no deficiencies of ambient NPKS nutrient concentrations existent at the site for aerobic biodegradation to take place. Investigations into the efficacy of aerobic and anaerobic cosubstrates (“cosubstrate screening”) were conducted to determine oxygen consumption and redox potential, respectively. This was done to assess the performance of 4 candidate aerobic cosubstrate and 5 anaerobic cosubstrates being considered. The results of cosubstrate screening indicated that two anaerobic substrates (molasses, vegetable oil) two aerobic substrates (hydrogen peroxide, methanol), and an untreated reference standard, be selected for further testing on contaminants to determine bioremediation performance over a period of 55 days. In addition, qPCR gene testing was carried out on the anaerobic substrates to assess whether the gene copy count of dehalogenase *bvcA* and dehalogenase *bvrA* enzymes increased in the presence of the substrate or not. The testing was carried out to investigate the relative biodegradation potential of each of the substrates for mitigating both total CHC concentrations and BTEX concentrations, the results of which are indicated in the graphics below.

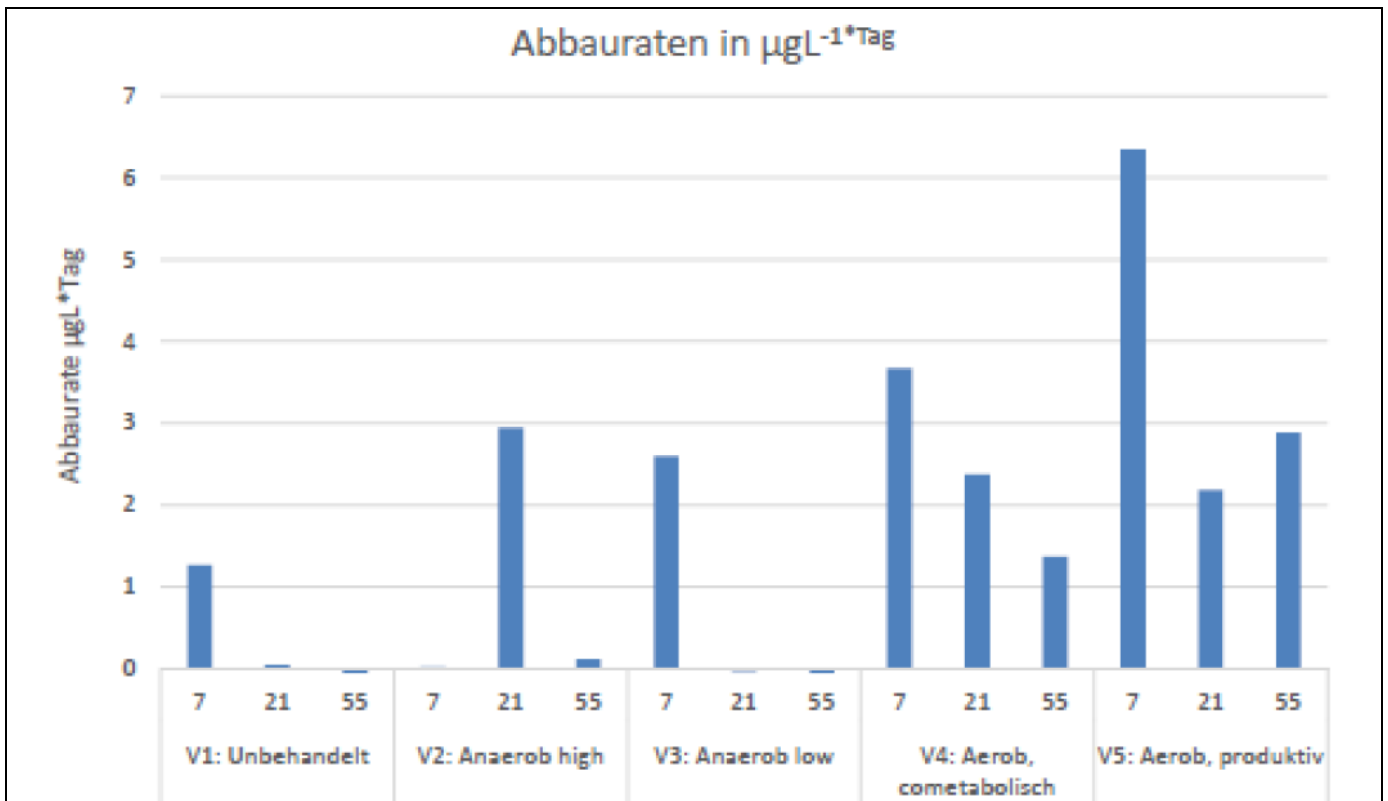

Degradation rates for total chlorinated aliphatic hydrocarbons (CHCs) using anaerobic and aerobic substrates

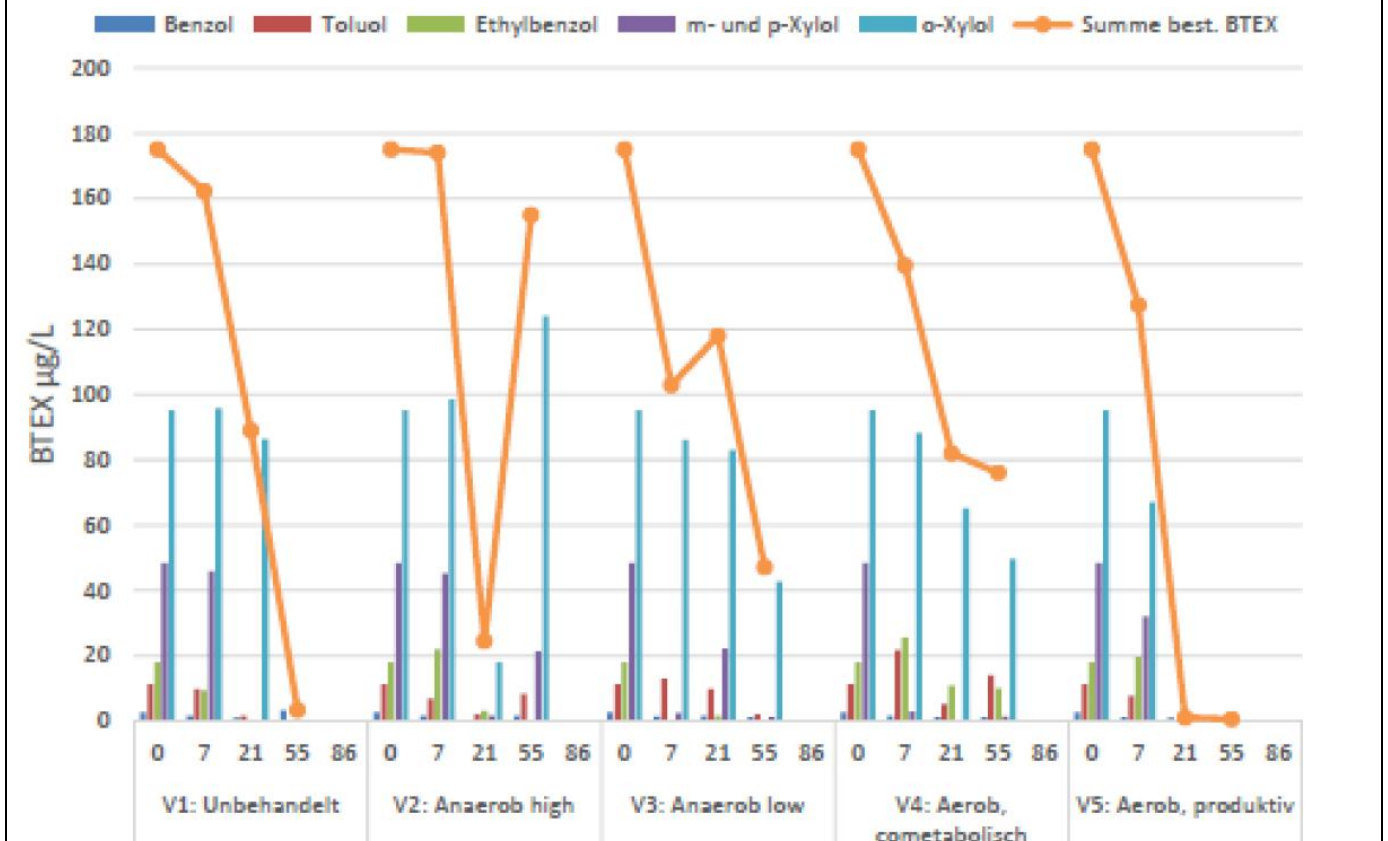



Degradation rates for aromatic petroleum hydrocarbons (BTEX) using anaerobic and aerobic substrates

The conclusions derived from the laboratory feasibility study are summarized as follows:

- Elevated background respiration rate of 7 mg/L/day O₂ within aquifer samples are indicative of strongly aerobic conditions.
- The most effective cosubstrates for degrading CHCs and BTEX contaminants were molasses (anaerobic cosubstrate) and methanol (aerobic substrate) at a concentration of 1000 mg/L respectively.
- Low concentrations of dehalogenase enzymes ($< 2 \times 10^3$) as measured by qPCR analysis suggests that ambient populations of dehalococcoidis within the aquifer may be inadequate to stimulate anaerobic dechlorination without additional bioaugmentation.
- The greatest biodegradation observed for CHCs and BTEX was by the aerobic process through the addition of oxygen (for this study, hydrogen peroxide).
- ISCO was recommended for the full scale remediation of the site for CHCs and BTEX



4. Pilot-scale application in field

4.1 Main treatment strategy

Based on the results of a comprehensive site-specific laboratory feasibility study to assess the efficacy of various in situ approaches (see previous section 3), and their demonstrated, long term experience in advanced ISCO applications in the field, neither the regulatory authority, environmental consultant, nor site owner expressed a need or desire for conducting a field pilot study.

5. Full-scale application

5.1 Main Reagent

The primary remediation strategy for the site-specific conditions (i.e. geology, contaminant situation, and hydrogeology) was to first conduct an ISCO treatment comprising:

- Targeted emplacement of an activated, dual- phase oxidant solids with significant treatment longevity (potassium persulfate activated by calcium peroxide);
- Construction of oxidant emplacement boreholes as injection wells;
- Monthly then quarterly groundwater sampling and analysis (“iterative feedback loop”);

“Secondary Treatment”, once indications that the primary oxidants were exhausted:

- Optimized reinjection of solution oxidants (sodium permanganate) into injection wells exhibiting contaminant rebound
- Continued groundwater monitoring (“iterative feedback loop”)

“Tertiary Treatment” follows in those remaining areas where contaminants persist:

- Enhanced aerobic bioremediation through slow release oxygen and nutrients

ISCO technology using solid phase oxidants emplaced by environmental fracturing (Targeted Solids Emplacement, “TSE[®]”) was selected due to its cost-effectiveness for treating multiple contaminants (chlorinated and petroleum hydrocarbons) present in low- permeability soils (silty sands and clay), its relatively non-disruptive implementation (direct push drilling) compared to ex situ methods considered, and due to its environmental sustainability (contaminant destruction vs. transfer).

Potassium persulfate was chosen as the primary oxidant due to its ability to form sulfate

radicals by alkaline activation through the addition of calcium peroxide (aktivator and secondary oxidant). The potassium form of persulfate also provides greater oxidant longevity due to its relatively low solubility. Calcium peroxide, in addition to activating persulfate, ensures a steady supply of slow-release oxygen into groundwater even after the persulfate oxidant has been exhausted.

The ISCO approach implemented at the site was designed to oxidize primarily CHCs with secondary consideration to BTEX contaminants, as these had been largely removed in a limited excavation of surface soils at the site. Persulfate is effective in oxidizing these contaminants and is less sensitive to SOD than other oxidants considered, and less hazardous to handle on site.

Environmental fracturing using Targeted Solids Emplacement (TSE®) coupled with Direct Push drilling was used as the preferred emplacement technology to ensure the distribution of high-solids oxidant slurry at selected depth intervals within contaminated soil zones of at least 6 m radius from injection boreholes. A total of 15 injection boreholes were used to emplace over 10.000 kg of persulfate-peroxide oxidants (dry mass) to depths of 10,5 m below ground surface (bgs). The mixing and fracture-emplacement of oxidants took place over 2 weeks followed by 3 weeks of injection well drilling, construction, and well development.



High pressure injection/fracturing/ and mixing equipment used for fracture-emplacement of persulfate-peroxide oxidant slurry into subsoils through direct push drill holes

5.2 Additives

The ISCO approach implemented at the site required that high- concentration oxidant slurry comprising low-solubility, solid based oxidants be emplaced into low permeability subsoils. This method of oxidant emplacement differs fundamentally from a simple injection of a solution based oxidant at low concentration which is normally the case (e.g. 4% potassium permanganate solution).

In order to ensure that solid based oxidants stay suspended in a water based slurry during pumping, and to avoid oxidants being “screened out” by fine grained aquifer sediments during emplacement into subsoils, a food-grade organic polymer gel was used to thicken the slurry to the required viscosity to ensure its placement at a concentration of upwards to 40% oxidant solids throughout its radius of distribution..

5.3 Injection type

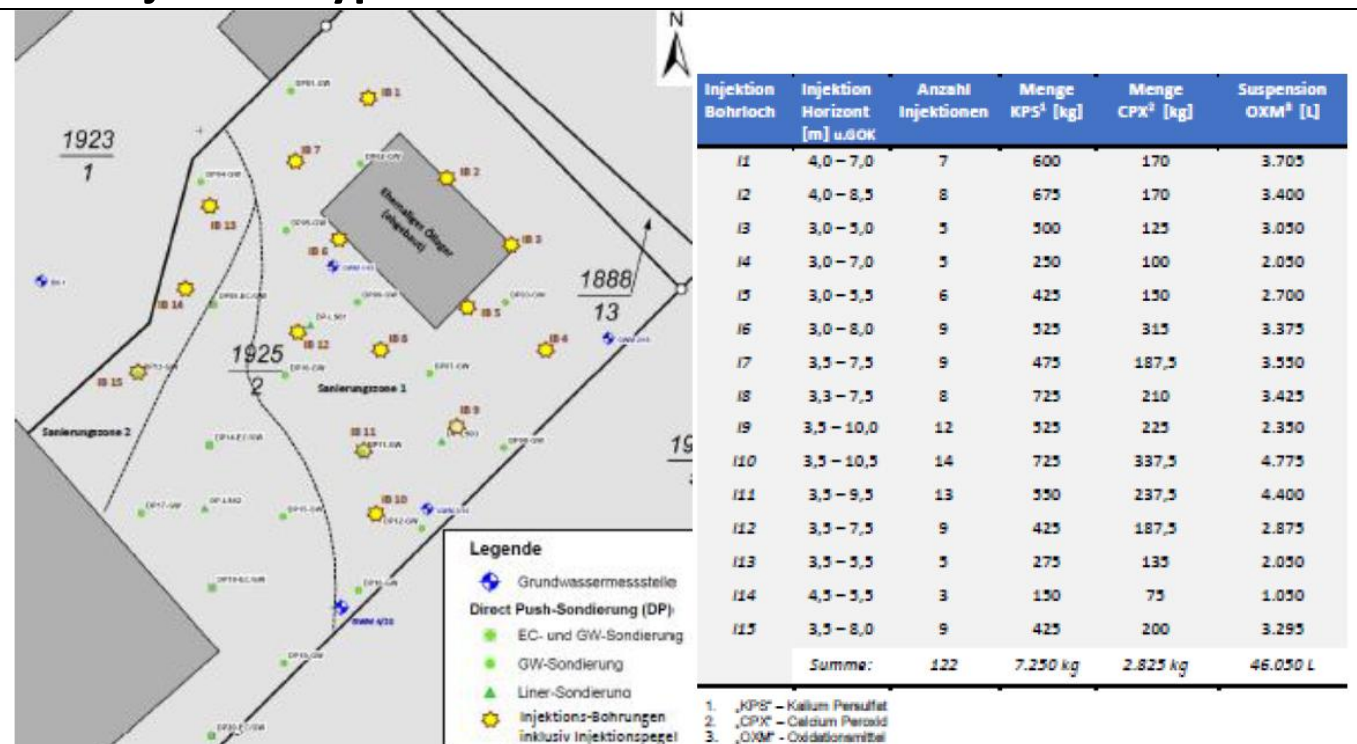

The fracture-emplacement of oxidant slurry using TSE® technology was achieved by advancing drill rods using Direct Push drilling equipment into subsoils to predetermined depths, followed by injection of slurry under hydraulic pressure using specialized high-pressure injection assemblies, and pumping and mixing equipment. The injections were conducted in a “top-down” approach, at 0,5 m depth intervals to the maximum depth of

impacts at each location. A total of 122 injections at 15 pre-determined locations within the contaminant plume was thus achieved (see site plan and table above).

Two of the injection boreholes were initiated in previous MIP investigation borings in order to minimize coring of the concrete surface. The spacing between borings was approximately 7 to 8 m which ensured overlapping oxidant distribution between injection points. All of the 15 injection boreholes were subsequently completed as 2" diameter (50 mm) injection wells for follow-up solution oxidant/biosubstrate treatment (where required), and for monitoring and sampling purposes.

All operational parameters were recorded during fracture-emplacement of oxidants (fracture and propagation pressures, flow rates, volume) including operational losses due to short-circuiting to ground surface (approx. 1% of the total volume injected). A typical injection profile is shown below.

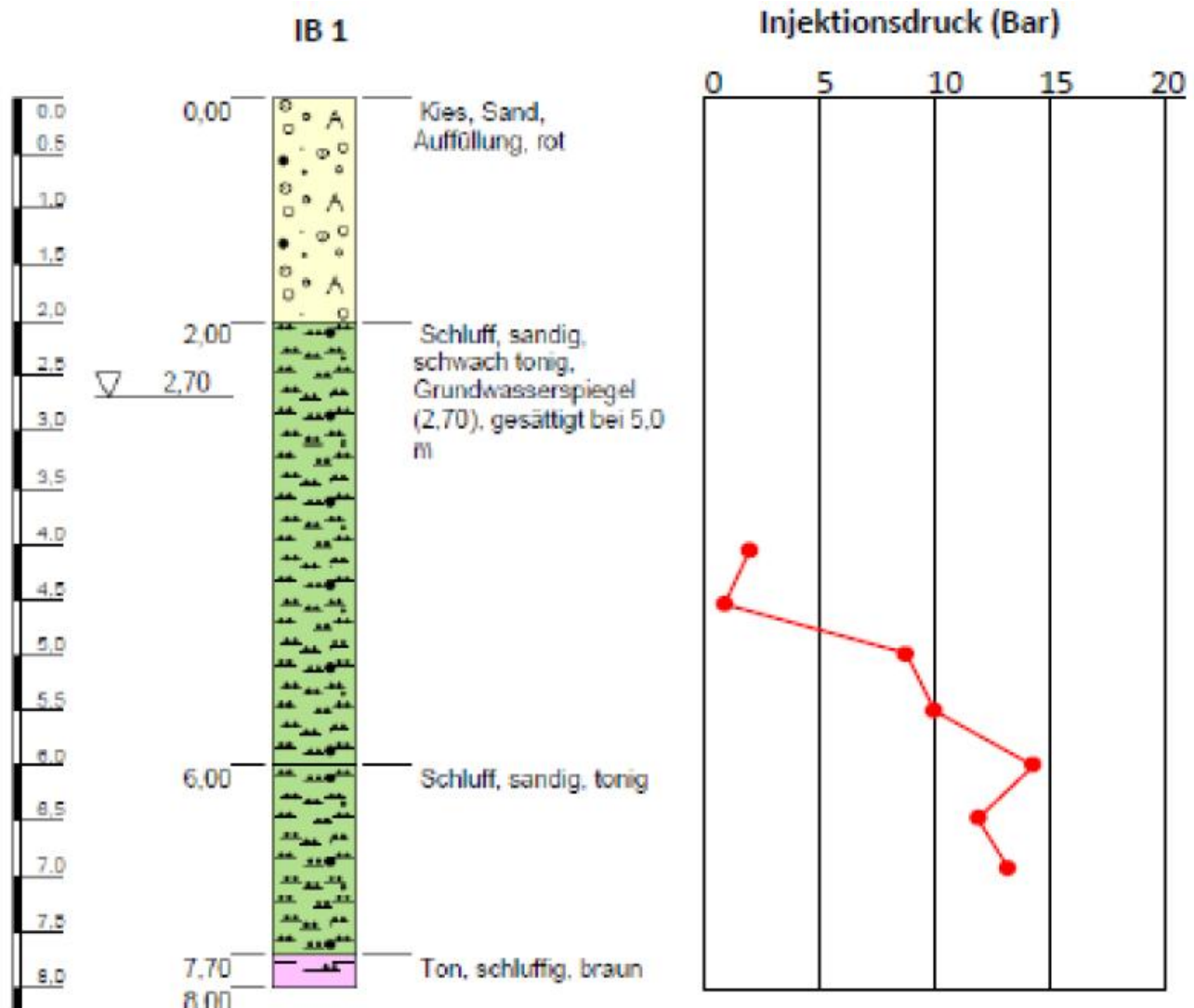

In this manner a total of 10,125 kg of oxidant (dry) mass was hydraulically emplaced throughout contaminated sediments as a slurry with total volume (including flush volumes) of approximately 46 m³.



5.4 Radius of influence

The determination of a “radius of influence” for the introduction of fluids into subsurface soils is seldom more than a theoretical calculation, as the actual “radius” of distribution is highly variable, even within a single injection point, as it is governed by soil heterogeneities (variable porosity, permeability, fines content), hydrogeological pressure gradients, and geotechnical/geotechnical properties of the subsurface (soil density, cohesion, plasticity, structure and fabric, and in situ stress conditions) see discussion in Section 7.2

In the case of the subject site, a theoretical radius of oxidant distribution of 3,5 m was used for the injection work at the site, although field observations indicated that the extent of oxidant distribution was upwards to 6 m at some locations.

5.5 Process and performance monitoring

Performance monitoring of control parameters to assess the effectiveness of ISCO remediation need to be tailored to the specific chemical characteristics of oxidants being applied, and the physical, geochemical, and microbiological parameters in groundwater. Important field parameters that were included in the post application monitoring comprised pH, electrical conductivity, redox potential, temperature and dissolved oxygen. Monitoring of pH is especially important in order to assess the buffering capacity of the soils and the potential of metals mobilization. Oxidant specific parameters included sulfate, dissolved and potassium (indicators of the primary oxidant, dissolved oxygen, potassium persulfate), as well as calcium, alkalinity, and dissolved oxygen (indicators of the secondary oxidant, calcium peroxide). Monitoring of the component cations in groundwater serve as an indicator as to the extent of distribution and relative concentration of oxidants present within the groundwater contaminant plume. Monitoring of contaminants included BTEX, CHCs (PCE, TCE, DCE, VC) was conducted, as were reaction products methane and carbon dioxide. Also included were analyses of metals.

Groundwater monitoring campaigns were carried out on a monthly basis for the first three months after oxidant emplacement and bi-monthly thereafter. Monitoring data and groundwater laboratory analytical have been collected over a span of 10 months so far.

6. Post treatment and/or Long Term Monitoring

6.1 Post treatment and/or Long Term Monitoring

Initial field parameter measurements taken within a month of oxidant emplacement within the contaminant plume area showed strong evidence of oxidation taking place, as indicated by elevated redox (electron activity) conditions ranging from 250 to > 600 mv, and dissolved oxygen levels ranging from 10 to > 40 mg/l

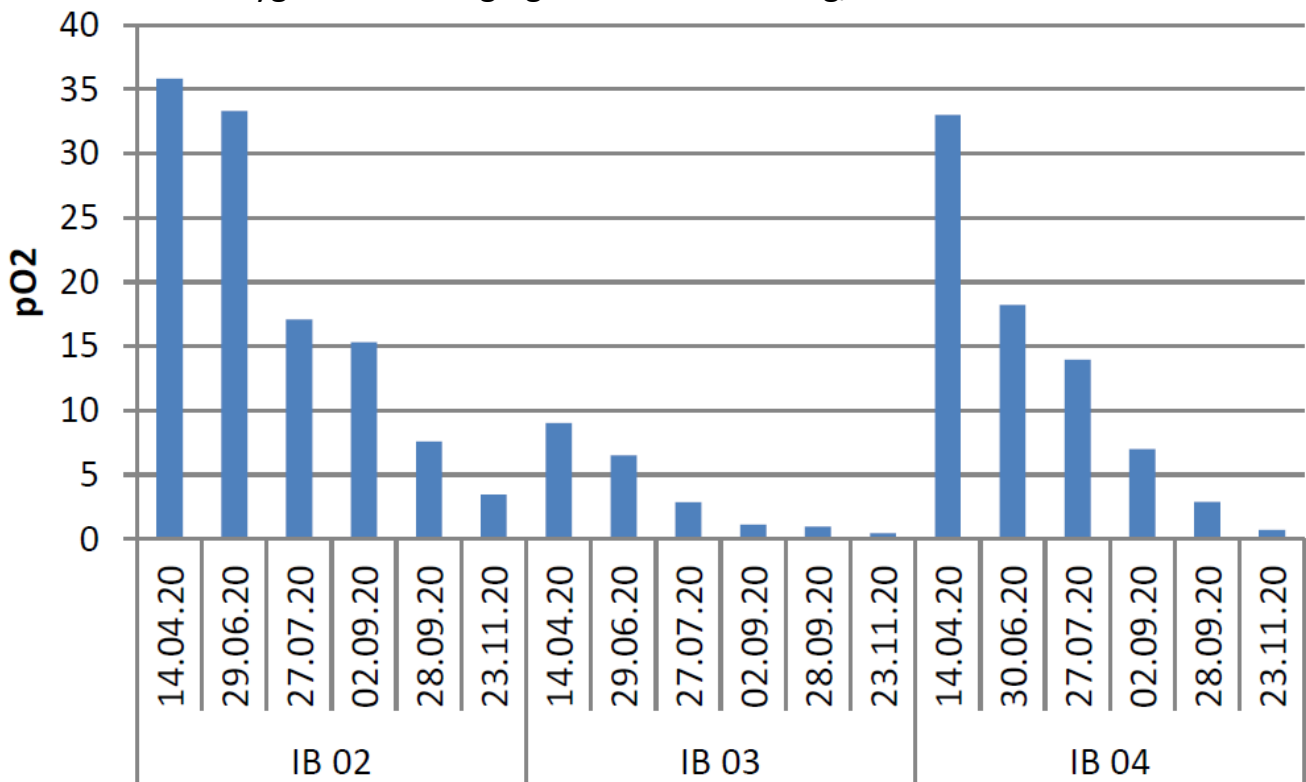

Typical oxygen depletion profile in plume area wells after injection

An assessment of oxidant longevity and contaminant persistence was made based on the decreasing concentrations of BTEX and CHCs in groundwater and the relative magnitude of contaminant rebound (where present) in the injection and monitoring wells over the monitoring period (10 months). The results indicated that of the 15 wells completed within the contaminant plume area:

- 1 well showed no contaminant rebound
- 6 wells showed moderate rebound effects (< 25 % of pre-treatment concentrations)
- 8 wells showed strong rebound effects (> 50 % of pre-treatment concentrations)

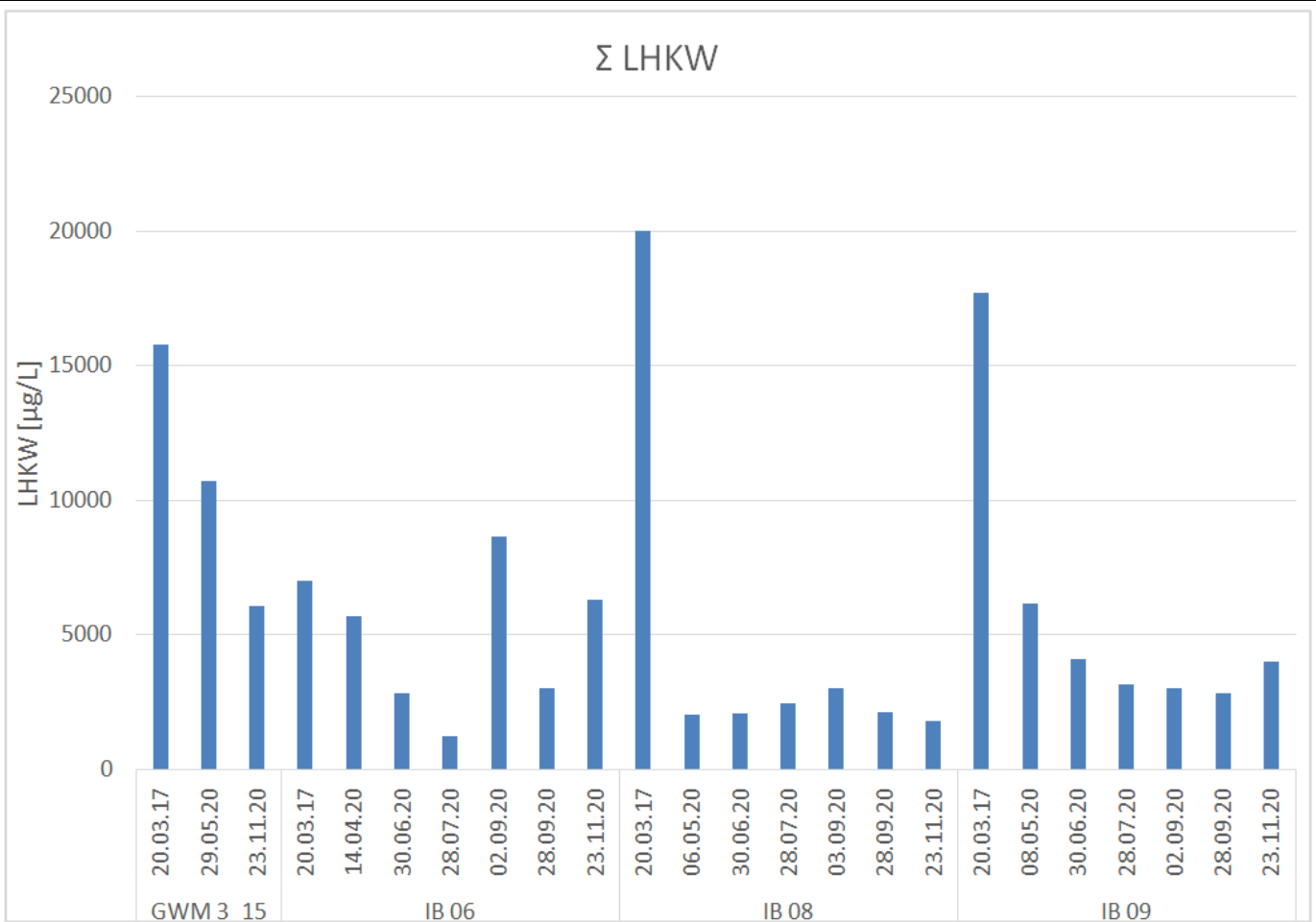

Typical CHC concentration profiles for: perimeter groundwater monitoring well GWM3_15; plume area wells IB05 (with rebound); plume area well IB07 (no rebound) after oxidant injection.

The collective assessment of field parameters such as redox and dissolved oxygen with geochemical parameters (e.g. sulfate) and contaminant concentration over time suggests that a longevity of approximately 4 to 5 months was achieved with the primary oxidant (persulfate), and a continuation of milder direct oxidation processes with oxygen (slow-release peroxide) from the secondary oxidant for a few months longer.

Based on this initial phase of performance monitoring in the “iterative feedback loop” approach, a second round of oxidant injection is planned in 2021 for those wells exhibiting rebound effects. This process is continued until concentrations have reached a low enough concentration whereby microbial amendments can be effectively applied to “polish” the remaining residual and trace concentrations of contaminants to reach remedial goals.



7. Additional information

7.1 Lesson learnt

The subject site presented many challenges to an effective ISCO strategy, due to:

- Uncertainty as to origin of some contaminants (possibly off-site?)
- Extremely high concentrations of co-mingled and mixed chlorinated and petroleum hydrocarbon contaminants
- Low permeability of aquifer sediments
- Enforcement order to remediate
- Cost sensitivity
- Need for decommissioning of former building and shallow excavation of contaminants prior to in situ remedial work
- Presence of underground facilities (storage tank, pipeline)
- Nearby stream adjoining property
- Active business operations on property

Before an ISCO plan was even considered, the property was subject to high resolution characterization (Direct Push MIP and EC investigation) in order to better delineate the lateral and vertical extent of contaminants to allow a better estimation of contaminant mass in the subsurface. This was done in conjunction with pump testing and soil vapour extraction trials which determined that pump and treat and vacuum extraction were not feasible remedial methods for the site geology.

These data formed the basis of a laboratory feasibility study to assess applicable in situ oxidation and bioremediation options, which determined that ISCO was the preferable option in the initial stage of treatment.

The key to an effective ISCO treatment was to determine:

- Effective oxidation product(s) for treating both CHC and BTEX contaminants;
- Oxidant dosing rates which could be applied in the field for the various magnitude of contamination present across the site;
- Likely Mode of Distribution of oxidants (soil permeation or fractures) and best suitable drilling method for injection (auger, sonic, Direct Push, manchette wells with packer, open hole packers, etc)
- Optimization techniques in the field to minimize loss of oxidants to the ground surface through existing boreholes, underground structures, and backfilled soils
- Applicable monitoring parameters and frequency of monitoring/sampling
- Determination of plan and timing for follow-up injection treatment

Despite careful planning of the design based on the above criteria, problems arose in the field related to short circuiting (loss of oxidant slurry) to surface through backfilled soils



after recent excavation activities, and though old investigative boreholes not adequately sealed.

Attempts were made at an operational level to mitigate such losses by increasing fluid viscosity, and oxidant slurry density, while reducing total injection volumes to mitigate the surfacing of oxidants at certain injection locations. Oxidant slurry coming to surface was collected and stored in IBCs for subsequent injection at other borehole depths or locations.

Fracture-emplacement was the dominant mode of distribution of dual stage oxidants (slurrified potassium persulfate and calcium peroxide, supplied by *PeroxyChem*) which proved effective over a period of at least 5 to 6 months. “Iterative Feedback Loop” monitoring of post-injection groundwater quality was effective in determining those locations within the contaminant plume where, and to what extent, follow up injections (oxidants or bioamendments) are required. This example of a staged, treatment train approach to in situ remediation optimizes the resources (time and material costs) related to achieving site-specific remedial objectives at site without disruption to ongoing business operations.

7.2 Additional information

The determination of a “radius of influence” for the introduction of fluids into subsurface soils is seldom more than a theoretical calculation, as the actual “radius” of distribution is highly variable, even within a single injection point, as it is governed by soil heterogeneities (variable porosity, permeability, fines content), hydrogeological pressure gradients, and geotechnical/geomechanical properties of the subsurface (soil density, cohesion, plasticity, structure and fabric, and in situ stress conditions).

In fact the “radius” of distribution for liquid and solid treatment amendments is in most cases not a radius at all, rather a measure of the general extent of oxidant distribution from the point of injection. The distribution can be elliptical, off-center, or asymmetrical for example. This is due to the fact that distribution is a function of the inherent properties of injected amendments (viscosity, temperature, pH, polarity, particle size, ionic properties, precipitation, etc.) as it relates to soil properties. Therefore, a fundamental consideration in the estimation of the effective lateral Extent of Amendment Distribution (EAD) to a site is an assessment of the likely Mode of Distribution that is to be expected, based on the physical and chemical characteristics of the treatment amendment to be injected in relation to the soil characteristics (primarily porosity and permeability) being injected into. This is extremely important, as it is the mode of amendment distribution which will govern the actual extent of subsurface distribution for any given amendment



into soil or even bedrock, and can vary significantly. Therefore, the likely mode of distribution must be recognized in any remedial design involving the introduction of treatment amendments into subsoils.

Empirical evidence for the Mode of Distribution of liquid and solid phase chemical and biological treatment amendments in various geology over two decades of project work at sites across North America, Europe, and Asia was summarized by Bures (2009) as follows:

Injection of Amendments: Mode of Distribution is important!

Infiltration if: $D_p < \sqrt{K_f/7}$ or ... Induced Pathways (FRAC) if: $D_p > \sqrt{K_f/7}$
Harris and Odem, 1982 (Dp: Particle Diameter in microns, Kf in millidarcys)

COMMON AMENDMENTS EMPLACED	MODE OF AMENDMENT EMPLACEMENT INTO SOILS AND BEDROCK (with respect to Hydraulic Conductivity)									
	>10 ⁻³ m/s	10 ⁻³	to	10 ⁻⁵	<10 ⁻⁵	<10 ⁻⁶	<10 ⁻⁷	<10 ⁻⁸	<10 ⁻⁸	<10 ⁻⁶ m/s
	Gravel	coarse Sand	medium	fine	silty Sand	Silt	silty Clay	Clay	Competent Bedrock	Fractured Bedrock
Silica Sand (Proppant)	INF	FRAC	FRAC	FRAC	FRAC	FRAC	FRAC	FRAC	FRAC	FRAC
Coarse Zero Valent Iron	INF	FRAC	FRAC	FRAC	FRAC	FRAC	FRAC	FRAC	FRAC	FRAC
Micro- Iron	INF	INF	INF/FRAC	INF/FRAC	FRAC	FRAC	FRAC	FRAC	FRAC	INF/FRAC
Oxidant Solids (as slurry)	INF	INF	INF	INF/FRAC	FRAC	FRAC	FRAC	FRAC	FRAC	INF/FRAC
Oxidant Liquids (In solution)	INF	INF	INF	INF	INF	INF/FRAC	FRAC	FRAC	FRAC	INF
Solution Bio-Amendments (Lactates, Vegetable Oils)	INF	INF	INF	INF	INF	INF/FRAC	FRAC	FRAC	FRAC	INF
Viscous Bio-Amendments (Molasses, Whey, etc.)	INF	INF	INF	INF	INF/FRAC	FRAC	FRAC	FRAC	FRAC	INF
Solid Bio-Amendments (Cellulose, Chitin)	INF	INF/FRAC	FRAC	FRAC	FRAC	FRAC	FRAC	FRAC	FRAC	INF/FRAC

INF = Infiltration and permeation through pore space is the primary mode of amendment emplacement.

FRAC = Targeted Solids Emplacement (creation of a network of permeable treatment Pathways) is the primary mode of amendment emplacement.

In general, the mode of distribution of a liquid or solid treatment amendment in subsoils and bedrock can be estimated by a comparison of the particle size of the material to be injected to the pore throat diameter of the receiving geology, which can be defined as the square root of: formation permeability, Kf, divided by seven (Harris and Odem, 1982). For treatment amendments where the particle size is smaller than the pore throat diameter, the mode of amendment distribution is by pore space permeation (blue area above). If



the amendment particle size is smaller than the available pore throat diameter, then the mode of distribution is through the formation of a fracture, defined by its thickness, width, length, orientation, and inclination to the ground surface (green area above).

Even for liquid amendments where the receiving geology has tiny pore space measured in angstroms, (e.g. clays), the mode of amendment distribution will trend towards a fracture, since even moderate injection rates cannot be accommodated by low effective porosity soils, resulting in a tensile failure of the soil and the creation of a fracture.

There can also be instances where the amendment being emplaced into the subsurface exhibits characteristics of both infiltration through pore space by permeation and the formation of a fracture. These are so called “hybrid” fractures, that is, fractures with significant “leak off” into surrounding soil pores.

Why is this important? Because the mode of emplacement has a significant bearing on the radius of influence and the transport processes for contaminant distribution via injection techniques in subsoils. For example, even the injection of solution based, liquid amendments (oxidants or bioamendments) will result in the formation of fractures or hybrid fractures in soils with hydraulic conductivities of $< 1 \times 10^{-6}$ m/s. For any given volume of solution amendment injected, therefore, the observed “radius of influence” will appear to be much greater than what would normally be expected if this calculation were based on the assumption of permeation. A volume of 1000 L of liquid amendment injected into a soil with an effective porosity of 10 % will correspond to a theoretical radius of influence of roughly 1,8 m per m of well screen if permeation through pore space were assumed, but the same volume would result in an theoretical fracture radius of 8 m (!!) if soil permeability is insufficient to allow radial porous flow. Therefore it would be prudent to know what the predominant mode of distribution to be expected at a site is, before implementing a full scale remedial design using “radius of influence” calculations, and hence injection well spacing, that are possibly based on faulty premises.

An equally important consideration in the importance of understanding the mode of distribution is the contact mechanism of injected amendments with respect to contaminants. Injection by radial permeation through the pore space in soils with relatively high permeability results in advective and dispersive mixing with dissolved phase contaminants. In contrast, the mechanism of contaminant treatment via emplacement of treatment amendments by fracturing, which by implication means in fine grained soils, is primarily through pressure induced penetration into soils at the fracture face, chemical gradient, and diffusion of oxidants from fractures into soil mass between individual fractures (see below).

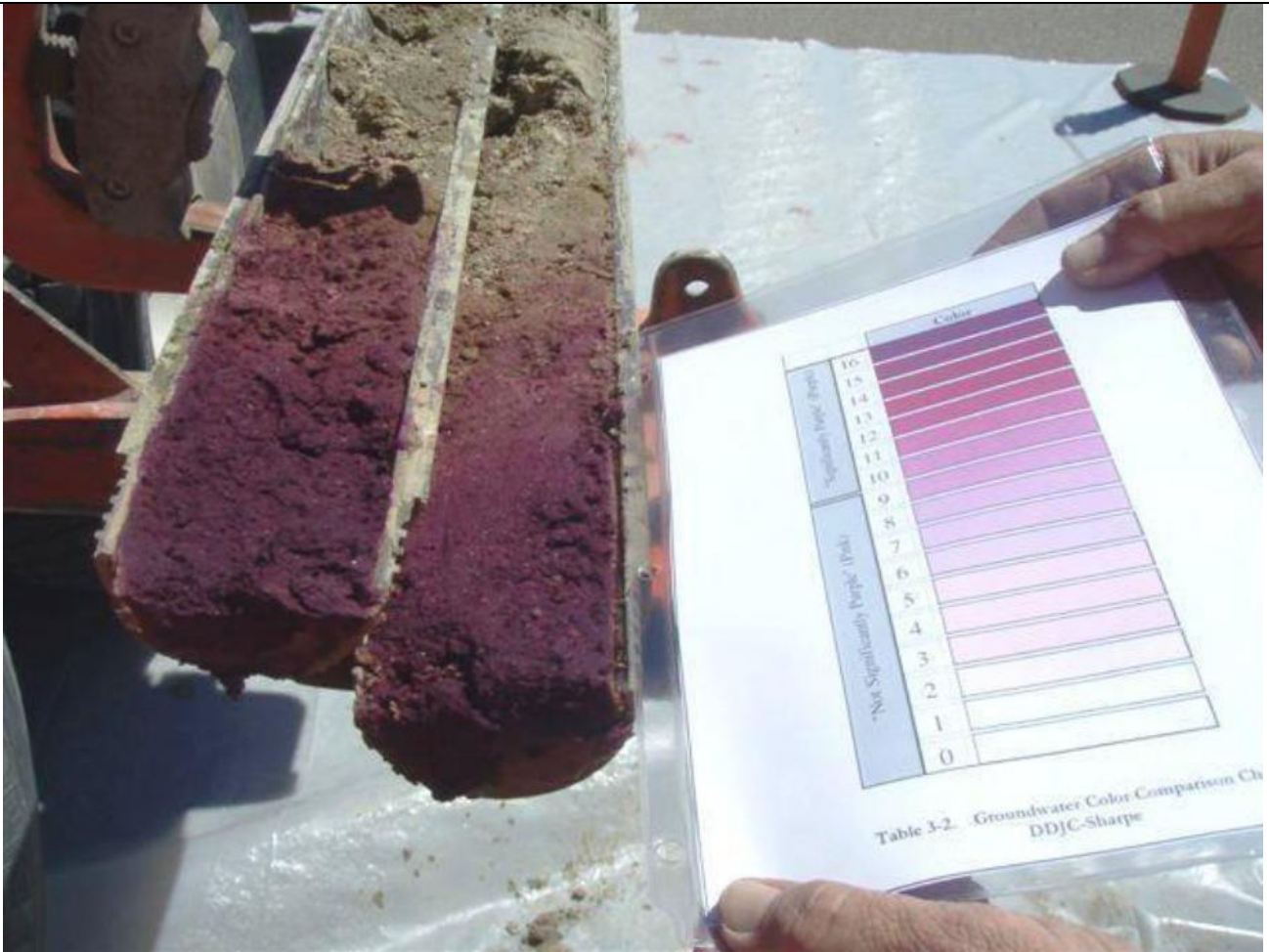

Example of oxidant diffusion profiling in silt soil cores 90 days after fracture-emplacment of potassium permanganate oxidant slurry (bottom of core) Photo courtesy of URS, 2006 – Bures archive

7.3 Training need

Effective in situ remediation using oxidants requires a multi-disciplinary approach across a wide spectrum of scientific and engineering know-how. The end effect means that remedial design, and particularly the practical application of ISCO can be complicated, as it requires specialized knowledge in:

- Geology
- Groundwater hydraulics
- Organic and inorganic chemistry
- Biochemistry
- Polymer chemistry
- Fluid mechanics



- Soil / Rock mechanics
- Drilling technology
- Injection technology
- Mixing and pumping technology
- Tracer and geophysical mapping technology
- Risk assessment
- Knowledge of regulatory requirements

It become obvious that based on the comprehensive suite of expertise required above, that the effective application of ISCO is very much a team effort. Although much of the expertise listed above are standard fields of study at universities or technical colleges, there is simply no substitute for experience gathered on actual project applications. Therefore, academic and industry workshops, conferences, technology specific webinars, and shared practical experience are of significant importance for anyone wishing to be a competent practitioner in this field.

7.4 Additional remarks

Any meaningful discussion of in situ chemical oxidation (ISCO) is incomplete without an understanding of the Mode of Distribution of oxidants being introduced into the subsurface environment and Contact Optimization with contaminants residing there. These considerations are essential elements for achieving remedial success using an ISCO approach, yet tend to be poorly understood by many working in this field. Fortunately, there exist a variety of innovative remedial enhancement and remedial performance monitoring technologies to rectify these shortcomings, among others:

- Dual– or multiple component oxidant formulations with a variety of activation mechanisms to achieve the highest oxidation potentials for oxidizing even mixed or co-mingled subsurface contaminants (e.g. CHCs and TPH) over long periods
- Incorporation of environmentally benign surfactant technology into the ISCO process to improve the performance oxidants by improving contaminant availability and oxidant penetration into pore spaces
- Specialized mixing, pumping, and rapid delivery technologies that enable precise and targeted emplacement of high concentration oxidant solids (as slurry) into permeable as well as impermeable sediments, including bedrock (e.g. TSE[®] technology with Direct Push drilling), or the emplacement of permeable pathways (e.g. sand fractures) in low permeability soils which can then be repeatedly injected with oxidant solutions.
- Employing the use of non-intrusive and robust geophysical techniques to map

subsurface distribution of liquid or solid oxidants from their point of delivery either as radial permeation, fracture propagation, or hybrid distribution in subsurface sediments (e.g. SensaTrax® tiltmeter geophysics):

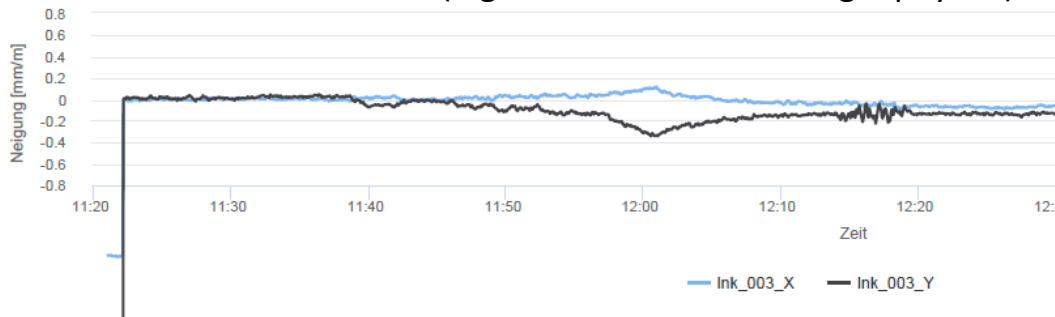

Furthermore, ISCO as a remedial application should not necessarily be viewed as the sole approach to site remediation, as by itself it rarely achieves every remedial target goals for every contaminant at every site. Rather it should be seen as part of a Treatment Train approach whereby oxidation can, at an appropriate point in the remedial process, be transitioned into a more passive bioremediation approach (aerobic or anaerobic Engineered Natural Attenuation, “ENA”) to mitigate remaining contaminants to their remedial endpoints.

Glossary of Terms

Term (alphabetical order)	Definition
BTEX	Benzene, Toluene, Ethylbenzene, Xylenes
CHC	Chlorinated aliphatic hydrocarbons
TPH	Total petroleum hydrocarbons
DCE	Dichlorethylene
EAD	Lateral, effective Extent of Amendment Distribution
ENA	Engineered natural attenuation
IFL	Iterative Feedback Loop
ISCO	In situ chemical oxidation
ISBR	In situ biological remediation
MIP	Membrane interface probe (high resolution characterization of contaminants)
PAH	Polycyclic aromatic hydrocarbons
PCE	Tetrachlorethylene
SOD	Soil Oxidant Demand
TCE	Trichloroethylene
TMB	Trimethylbenzene
TSE®	Targeted Solids Emplacement (by Sensatec GmbH)
VC	Vinyl chloride

1. Contact details - CASE STUDY: ISCO n.7

1.1 Name and Surname	Hadas Sharon
1.2 Country/Jurisdiction	Israel
1.3 Organisation	Ludan environmental technologies
1.4 Position	Environmental engineer
1.5 Duties	Project manager
1.6 Email address	hsharon@ludan.co.il
1.7 Phone number	+972 52-511-2139



2. Site background

2.1 History of the site: Challenges and Solution

- Background- In an industrial area in Israel contamination from solvents was found in groundwater from the site. Apparently due to the industrial activity of some factories from the 1950s.
- The remediation was performed as part of a change in the site designation from industrial activity to commercial activity.
- Characteristics of the contamination - In investigations performed on the site over the years, high concentrations of chlorinated solvents were found, the main one was trichloroethylene (TCE).
- The goal- reduction of the concentrations of chlorinated carbon in the groundwater, in a total area of about 300 square meters. The reduction was examined by comparing the target values as agreed with the Water Authority.
- The selected rehabilitation technology- An alternative survey was prepared for the remediation of the site. Following its findings, it was decided to treat the groundwater by injecting a chemical oxygen (potassium permanganate KMnO_4).
- The main challenge in performing the remediation - during the remediation period, construction work was performed to establish a new tower and an underground parking in the site, therefore safety measures had to be taken so that the combination of installing the foundations of the tower during the remediation period would be possible.

2.2 Geological and hydrogeological setting

- The soil at the site is sandy.
- The depth of the groundwater at the site, approximately 20 m below the ground.

2.3 Contaminants of concern

The results of the groundwater sampling show that the contaminants whose concentration exceeded the threshold values are trichloroethylene, manganese and chromium.



2.4 Regulatory framework

- In Israel, water remediation is in the responsibility of a government ministry - the Water Authority.
- The remediation plan and remediation reports are reviewed and approved by this authority.
- The following is a list of the target values of the contaminants, as approved by the Water Authority:
 1. Tetrachlorethylene - 187 µg/L
 2. Trichloroethylene - 374 µg/L
 3. 1,1-dichloroethylene - 187 µg/L
 4. cis-1,2-dichloroethylene - 935 µg/L
 5. trans-1,2-dichloroethylene - 935 µg/L
 6. Vinyl Chloride - 9 µg/L

3. Laboratory-scale application in field

3.1 Laboratory scale application

Performing preliminary actions included:

- TOD test - as part of the installation of the injection wells, soil samples were taken to perform tests for the "natural oxygen demand" of the soil. Based on the results, precise calculations of the amount of oxygen and solution volumes required for the treatment of the contaminant on the site were performed.
- Pilot test - This test included injecting water in small volumes in order to examine injection rates, pressures and flow rates in the various wells before performing the oxidizing injections.



4. Pilot-scale application in field

4.1 Main treatment strategy

- The work includes three main stages:
 - **Stage A** - performing a preliminary pilot - checking flow rates and pressures
 - performing tests in the field and in the laboratory to determine the injection parameters.
 - **Stage B** - Perform the complete remediation by performing the injection.
 - **Stage C** - Concluding monitoring of groundwater to examine compliance with remediation, in accordance with target values of the contaminants.
- This remediation technology was chosen after examining all the remediation options.
- Considering the characteristics of the site and the fact that during the remediation period construction on the site was being carried out at the same time, it was decided to apply this technology.
- The challenge in this project was to enable the construction work and the construction of the underground parking at the same time as the groundwater treatment at the site.
- The oxidation injection was performed through 8 double injection wells to a depth:
 - Shallow: 0–3 m below groundwater level. Deep: 3.5–8 m below groundwater level.
 - The injections were performed for 3 days during which approximately 93,300 liters of permanganate solution were injected at concentrations of 0.5% to 2%, which included 1,025 kg of potassium permanganate.
 - At the end of the injections, air was injected for about three weeks to disperse the oxidants in the horizontal dimension so as to increase the distribution of oxygen in the aquifer.
- In order to monitor the remediation process, every six months groundwater monitoring and sampling was carried out for laboratory analysis of contaminants and geochemical parameters.



4.3 Injection type

- The layout of the wells at the center was designed according to the treatment area, the depth of contaminant concentration, the oxidizing properties and the soil properties.
- The permanganate solution, similar to the TCE substance, has a higher density than water and therefore, by its nature, "sinks" downwards. Therefore, the layout of the wells in the vertical axis was designed so that the effect of the treatment by the injected solution would cover the entire incision, up to a depth of 8 meters below groundwater level.
- The injections were performed for 3 days during which, approximately 93,300 liters of permanganate solution were injected at concentrations of 0.5% to 2%, which included 1,025 kg of potassium permanganate.

4.4 Radius of influence

- The radius of impact was defined as 4m in the horizontal dimension in accordance with experience from other sites with similar characteristics and in accordance with preliminary tests that included injecting water in limited volumes to test injection rates, pressures and flow rates in the various wells before performing the oxidation injections.



4.5 Control parameters

Field monitoring and sampling program that will adequately monitor both the dispersion of the oxidant and the effectiveness of the treatment in three dimensions are required. Usually measurements concerning oxidant dispersion are conducted more frequently than COC analysis and are completely different if the oxidant is in liquid or gas form.

- Below is the sampling frequency of the monitoring wells:
 - Before the injection
 - A month and a half after the injection
 - Three months after injection
 - Nine months after the date of injection
 - One year after the date of injection
- The following are the parameters tested in the groundwater sampling:
 - VOC
 - TDS
 - Metals
 - Alkalinity
 - Bicarbonate
 - Nitrite
 - Main ions
- The following are the field findings examined in the groundwater sampling:
 - ORP
 - EC
 - pH
 - OD



5. Full-scale application

5.1 Main Reagent

- Potassium Magnet (KMnO_4) - Permanganate in aqueous solution exists in the form of anion (MnO_4^-), as an oxidizer with high oxidizing power to organic hydrocarbons in general and chlorinated hydrocarbons in particular.
- The solution was applied in a concentration of 0.5% to 2%.
- There was no change compared to the pilot test.

5.3 Injection type

- The injection was performed through eight new double injection wells, which were installed as part of the Remediation project:
- Shallow strainer from 0 (water surface) to 3 meters deep.
- Deep strainer - from 3.5 meters to 8 meters deep.
- At the end of the injections, air was injected for about three weeks to disperse the oxidants in the horizontal dimension.
- The injection wells were placed as a rounded mesh cluster, 4 m apart.

5.4 Radius of influence

With no change from the pilot, as described in section 4.4



5.5 Process and performance monitoring

The injections included:

- Mixing the chemicals and preparing the injection solution in an outdoor facility.
- Transferring the injection solution to the site with the help of a dedicated tanker.
- Positioning the tanker on an elevated ramp at the site (20 m above the wellheads) and flowing the solution to the heads to the control and manifold.
- The control and monitoring manifold included a main faucet and a pressure gauge which allowed control of the injection flow to the wells and a system of faucets for controlling the flow of the solution to each faucet separately.
- A safety surface, made of flexible and thick HDPE (high density polyethylene) plastic, is spread out under the working point and the pipe branch, to prevent leakage outside the activity area in case of emergency.



6. Post treatment and/or Long Term Monitoring

6.1 Post treatment and/or Long Term Monitoring

A VOC analysis should be performed to detect chlorinated carbon concentrations as a result of the "rebound" effect.

7. Additional information

7.1 Lesson learnt

Injecting the oxygen at high pressure may cause it to leak from the surface of the soil. It should be injected at an adjusted pressure that will not cause leakage.

7.3 Training need

Training through workshops, preferably by the Ministry of Environmental Protection in order for the remediation processes to comply with the regulator's guidelines.

1. Contact details - CASE STUDY: ISCO n.8

1.1 Name and Surname	LORANT Camille (Site Manager) DEVIC-BASSAGET Boris (Technical Director)
1.2 Country/Jurisdiction	FRANCE: SUEZ RR IWS REMEDIATION FRANCE 17 rue du Périgord, 69330 Meyzieu (France) SPAIN: SUEZ RR IWS IBERICA, Camí Can Bros, 6 08760 Martorell (Barcelona)
1.3 Organisation	SUEZ RR IWS REMEDIATION FRANCE for SUEZ RR IWS IBERICA
1.4 Position	
1.5 Duties	International remediation team
1.6 Email address	Camille.lorant@suez.com boris.devic-bassaget@suez.com contact.remediation.europe@suez.com Juan Marti@suez.com
1.7 Phone number	+33(4)72450222



2. Site background

2.1 History of the site: Challenges and Solution

The site is located in the Salberdin industrial area within the town of Zarautz. Outside its boundaries are urban residential areas formed by collective housing. The Zarautz Railway Station is located in the northeast. The sea is present 500 m north of the site.

2.2 Geological and hydrogeological setting

Geological description (below topsoil, asphalt or concrete)

- 0 - 0.5 / 2 m: filling
- 0.5 / 2 - 2 / 3.8 m: clay
- 2 / 3.8 m - 2.2 / 4 m: clay silt
- 2.2 / 4 m -?: Sand

Presence of groundwater in the sand, direction of flow oriented towards the north, with an old channel.

2.3 Contaminants of concern

The site presents a contamination of the groundwater for chlorinated compounds in concentrations that exceed the normative reference values (max 23,000 $\mu\text{g/l}$ in cis-DCE and 2100 in vinyl chloride (VC)). A chlorinated plume extends to the west (S28, S6, S8)

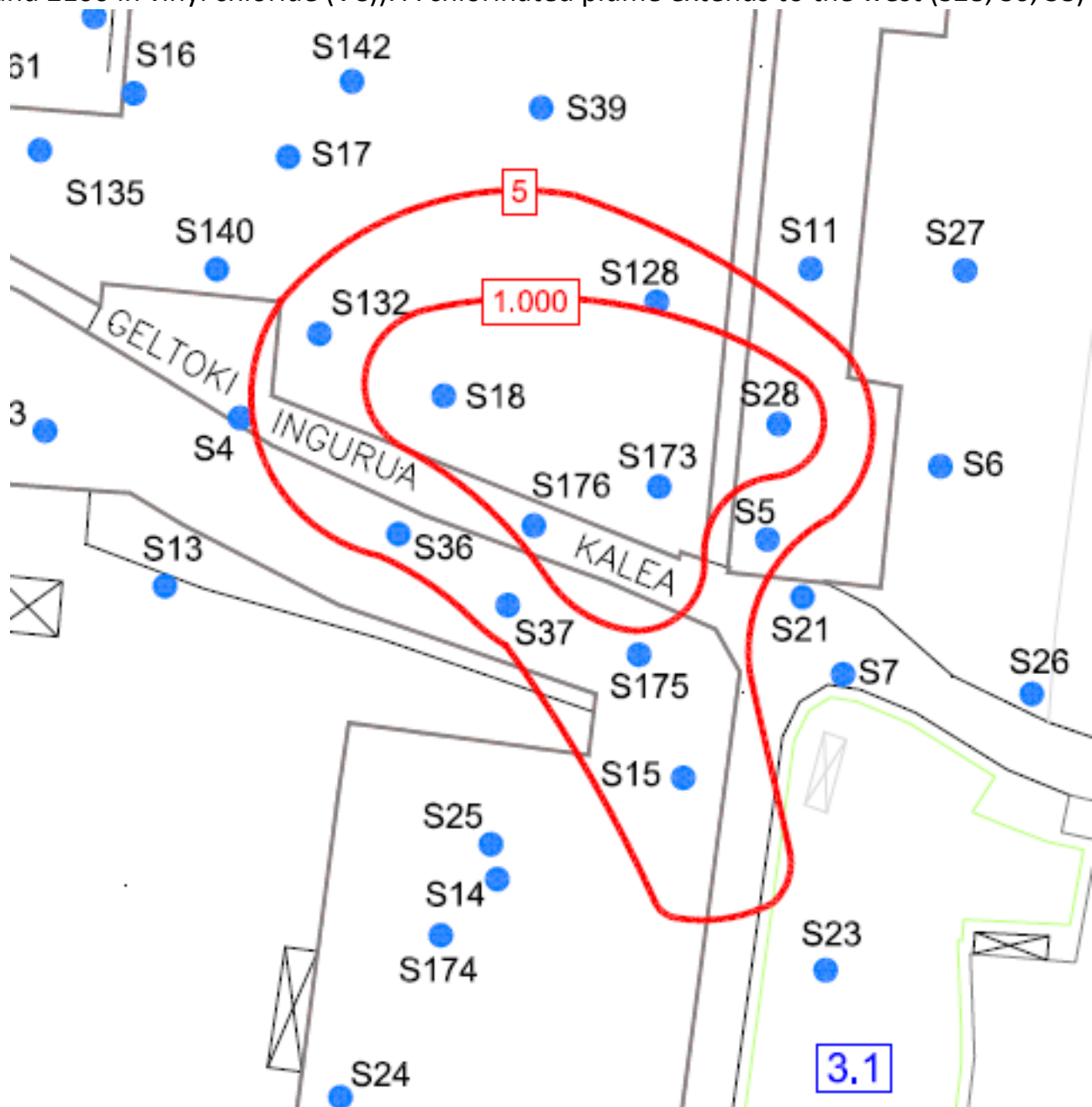

Vinyl chloride plume ($\mu\text{g/l}$)

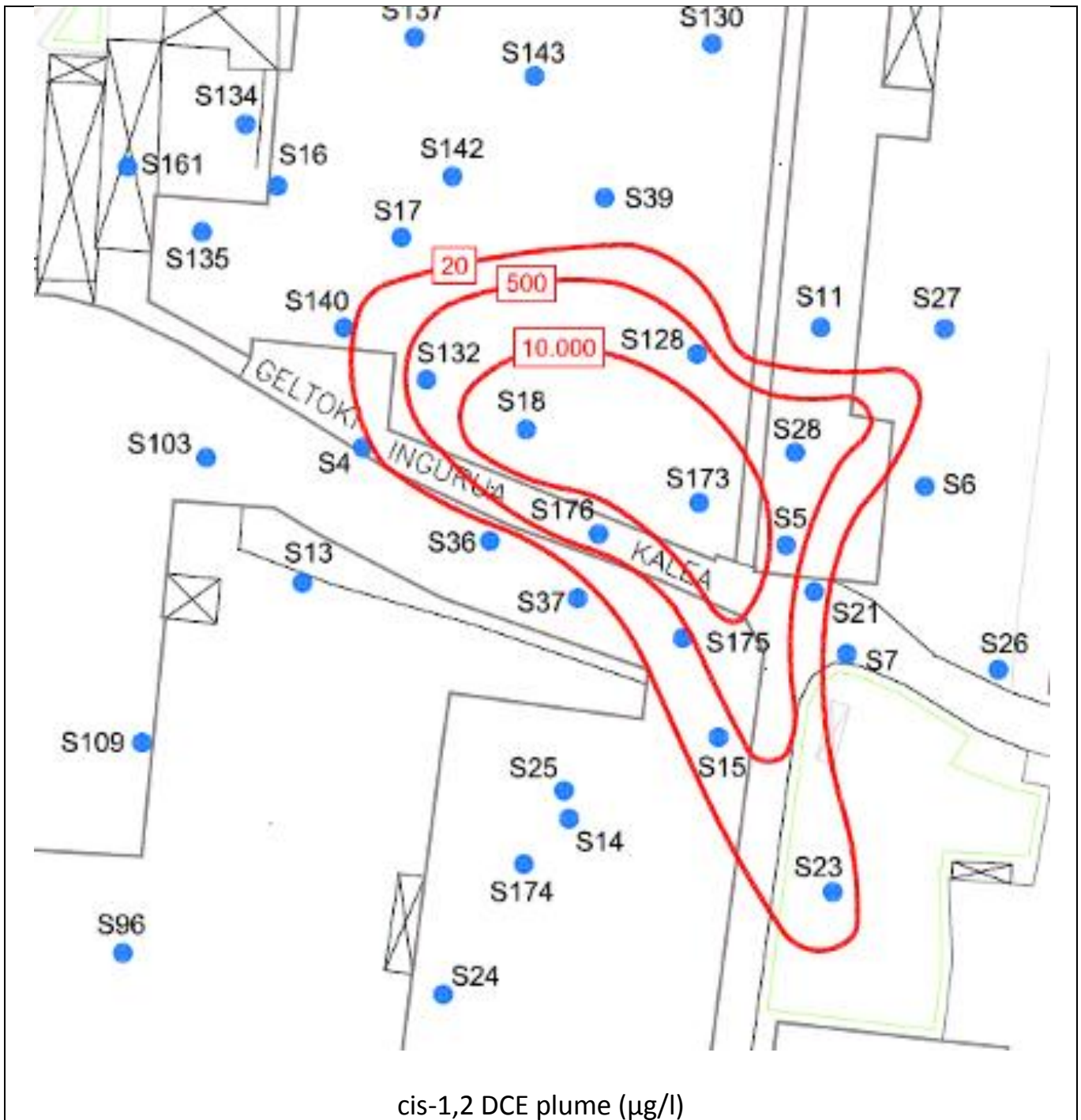



2.4 Regulatory framework

The aim of the treatment is to reduce the contaminating mass present in the groundwater and thus reduce or eliminate the potential health risks for the people living around it.

The treatment area corresponds to the right of way of the 88 injectors over a thickness of 10 m of aquifer.

The proposed target values for the impacted groundwater are presented in the table below:

Target values for groundwater ($\mu\text{g/l}$)

Interest compound	Target value ($\mu\text{g/l}$)
Vinyl Chloride	45
cis-1,2 Dichlorethylene	800
TPH AlifaticsC12-C16	30

Target values for groundwater ($\mu\text{g/l}$)

In addition, to evaluate the effectiveness of the treatment, SUEZ Remediation proposes the following reception criteria:

- 80% reduction in the average chlorinated solvent content,
- Minimum reduction of 50% on each individual piezometer,
- No abatement calculation for low concentrations $<100 \mu\text{g/l}$.

3. Laboratory-scale application in field

We did not carry out a pilot sizing test prior to the implementation of the ISCO treatment.



5. Full scale application

5.1 Main treatment strategy

The network of injection points consists of 88 points (I1 to I88), by means of a zoning in 3 areas with the following characteristics:

- Concentrated area, with a narrow network of structures of 31 injection points.
- Intermediate area, with a narrow network of structures with 27 injection points.
- Diffuse area, with a narrow network of structures with 30 injection points.

In each of the points, the injection of the reagent is carried out directly on the area where the aquifer develops, that is, on the basal stretch of sand located below the clayey silt and up to 10/12 m deep.

The injections were made with a system of 7 injection plates composed of

A system of non-return valves, a 3.5 bar pressure limiter, and a filter at the water inlet, A sodium permanganate IBC, connected to a dosing pump that allows to dilute the oxidant in line at 1 or 2%

3 lines with 1m³/h float flow meters, shut-off valves, to perform injections at each point.

NB: it is possible to connect the injection point directly to the system output to increase the flow rate to 3m³/h.

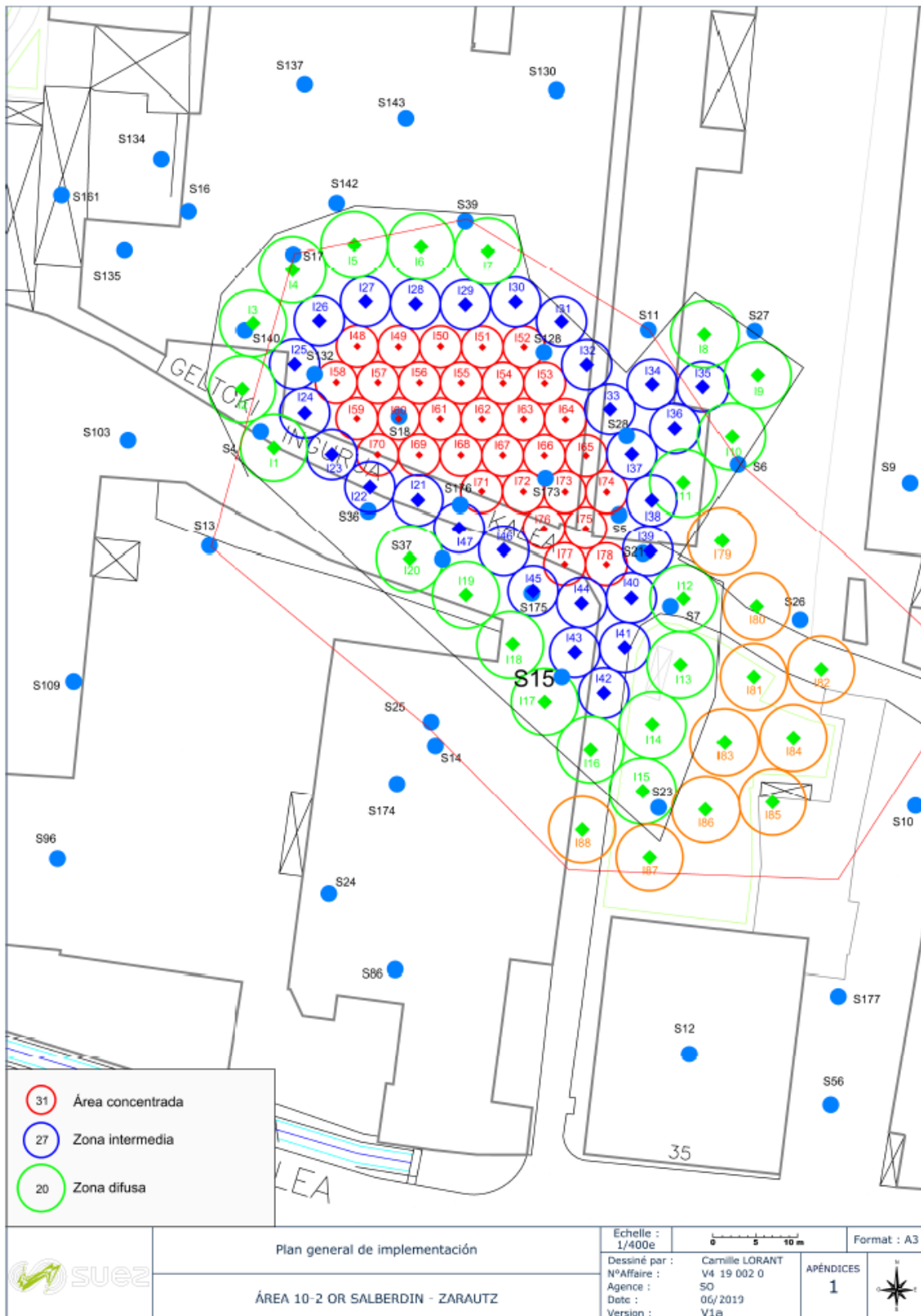







5.4 Radius of influence

The theoretical amount of reagent to be injected is based on

- the amount of pollutant present in the aquifer
- the void volume in the aquifer (taking into account the hydraulic parameters of the aquifer in this sector and the important porosity)

The sodium permanganate reagent with a solution dosed at 1 or 2%, is implemented according to several successive campaigns, separated in periods of 3 months.

Oxidant dosage in each of the injection campaigns

ISCO Campaign	Injection point number	Injected volume (m ³)	Quantity of 40% Permanganate (Tons)
1st campaign	88	1 385,5	19,5
2 nd campaign	24, recalcitrant points and/or with rebound effect	751	15: (9 + 5) In order to increase treatment performance according to SUEZ IBERICA and its client, 5 T of additional permanganate were injected during the second campaign

During the first injection campaign, SUEZ Remediation followed the theoretical dimensioning, namely

- Injection in each injector (88)
- Amount of permanganate solution at 40% (I): 16 m³
- Average dilution: 1.24%.
- Total volume of injected solution: 1385.46 m³
- Injection flow rate: 0.86 m³/h

For the second injection campaign, SUEZ Remediation has injected into the injectors where the VOCs were higher than the reference values.

In addition, Suez Remediation increased the dilution % and the injection flows (validated by a field test) to increase the diffusion of permanganate in the groundwater. The parameters are:

- Injection in each injector (24)
- Amount of permanganate solution at 40% (I): 12 m³
- average dilution: 1.65%
- Total volume of injected solution: 751.3 m³

Injection flow rate: 5.66 m³/h



5.5 Process and performance monitoring

In order to verify whether the water recovery targets are met and to define the evolution of the targets, the baseline situation will be determined and regular monitoring will be carried out to assess the progress of recovery.

During remediation, all wells and piezometers that present severe affection and values above the quality objectives, will be connected to the remediation system or for monitoring.

Likewise, periodic controls of the unaffected points were carried out to guarantee that the area of dispersion of the affection is not in expansion.

At the end of the treatment, after two injection campaigns, the results are:

For Cis1,2-Dichloroethylene,

- 87 out of 88 injectors have concentrations below the reference values, i.e. 99%
- the average reduction in concentrations between the initial state and the final state is 91%.

For vinyl chloride,

- 81 out of 88 injectors have concentrations below the reference values, i.e. 92%
- the average reduction in concentrations between the initial state and the final state is 91%.

1. Contact details - CASE STUDY: ISCO n.9

1.1 Name and Surname	Laura Valeriani, Federica De Giorgi
1.2 Country/Jurisdiction	Italy
1.3 Organisation	Golder Associates S.r.l.
1.4 Position	Engineering consulting firm – Environmental engineers
1.5 Duties	Italian Environmental Law (D.Lgs. 152/06, DM31/15)
1.6 Email address	lvaleriani@golder.it fdegiorgi@golder.it
1.7 Phone number	+39 340 88 95 457



2. Site background

2.1 History of the site: Challenges and Solution

The Site is a petroleum service station, with fuel storage in underground tanks, located in central Italy.

In 2005, the station was refurbished which included the replacement of the old underground tanks with new ones, which were installed in a different area of the Site. During the excavation for the removal of the old tanks, evidence of contamination was detected in the soil located below the tanks, therefore different environmental investigations were carried out over the year (in 2005, 2013, 2015 and 2017) on various environmental matrices (soil, groundwater and soil gas).

The results of the investigations showed the presence of two potential secondary sources of contamination, with exceedances of the Italian threshold limits (CSC D.Lgs. 152/06 and limits DM31/15):

- unsaturated deep soil (depth > 1m below ground surface (bgs)), with benzene, ethylbenzene, toluene, xylenes, light C_{≤12} and heavy C > 12 hydrocarbons and MtBE.

The maximum detected concentrations were:

benzene	163	mg/kg SS
ethylbenzene	502	mg/kg SS
toluene	648	mg/kg SS
xylenes	1,472	mg/kg SS
light hydrocarbons C _{≤12}	19,509	mg/kg SS
heavy hydrocarbons C>12	5,742	mg/kg SS
MtBE	736	mg/kg SS

- groundwater, with benzene, toluene, xylenes, total petroleum hydrocarbons and MtBE. The maximum concentrations were

benzene	163	µg/l
toluene	648	µg/l
p-Xylene	1,472	µg/l
Total hydrocarbons (as n-hexane)	19,509	µg/l
MtBE	736	µg/l

A human health risk assessment was developed for the Site, as required by Law. The assessment showed that the human health risk was acceptable but the Italian Law requires that groundwater contaminant concentration, at the wells located at the Site downgradient boundary, must meet with Italian threshold limits (CSC D.Lgs. 152/06). Some exceedance were detected in those wells and therefore groundwater remediation was deemed necessary for the site.

A screening of applicable remedial technologies was undertaken, using the screening matrix provided by ISPRA, showing that the best remediation technology for the Site is a combination of ISCO and bioremediation.

ISCO resulted more suitable for the area in which the old tanks were located, because of higher contaminant concentration. Bioremediation, i.e. the delivery of oxygen release compounds in the subsoil to stimulate hydrocarbons aerobic degradation, resulted more suitable at the Site boundary where the concentration of contaminants was lower.

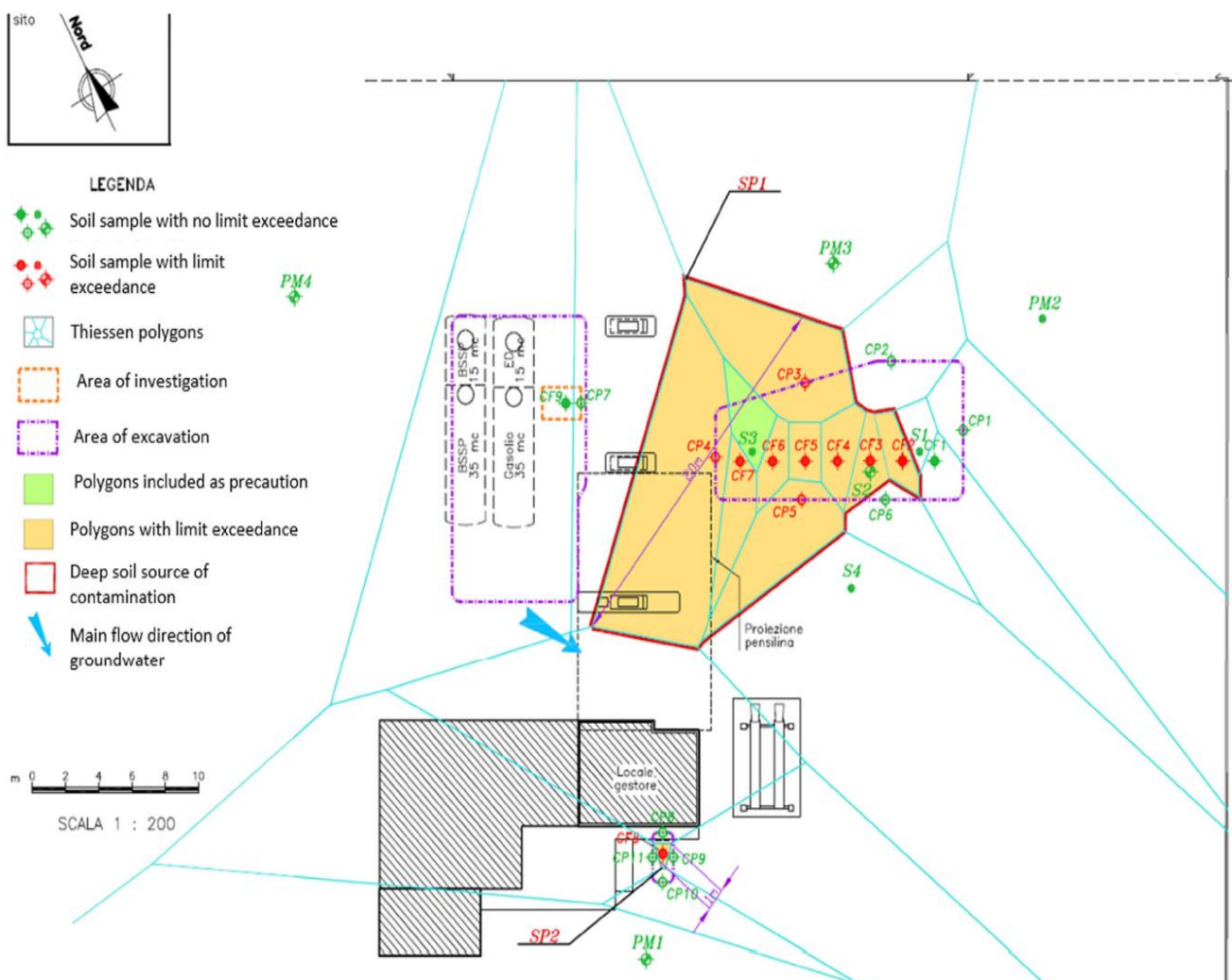

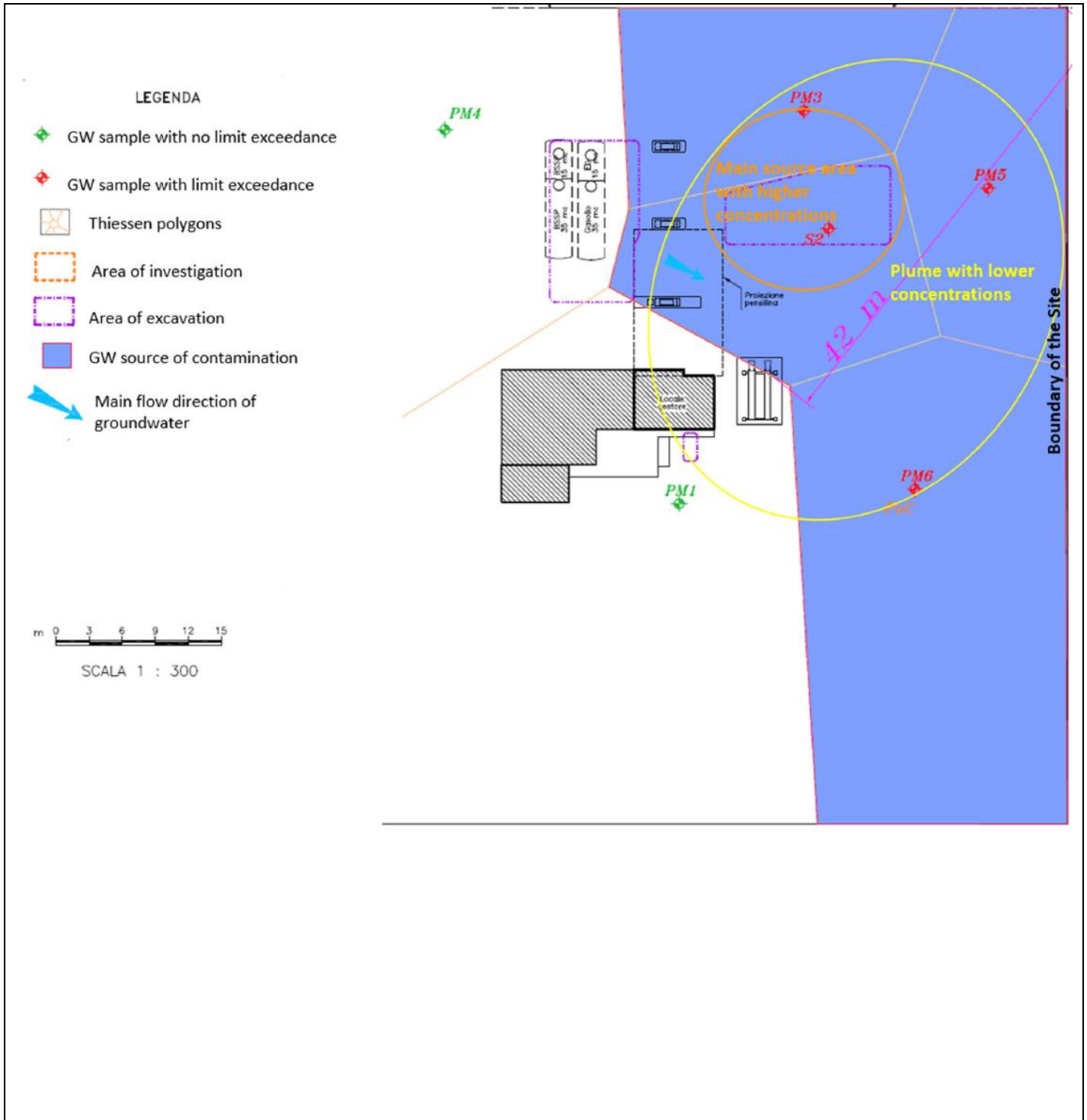

2.2 Geological and hydrogeological setting

Site soil consists of fill material up to a depth of 0.8 m bgs, followed by sandy silt or silty clayey sand up to 4.2 m bgs (sandy loam). Below the latter fine to medium-fine sand is found up to the maximum investigated depth equal to 10 m from bgs (loamy sand).



The depth to groundwater is approximately 11 m bgs, with flow direction mainly south-southeast and 0.5% of hydraulic gradient.

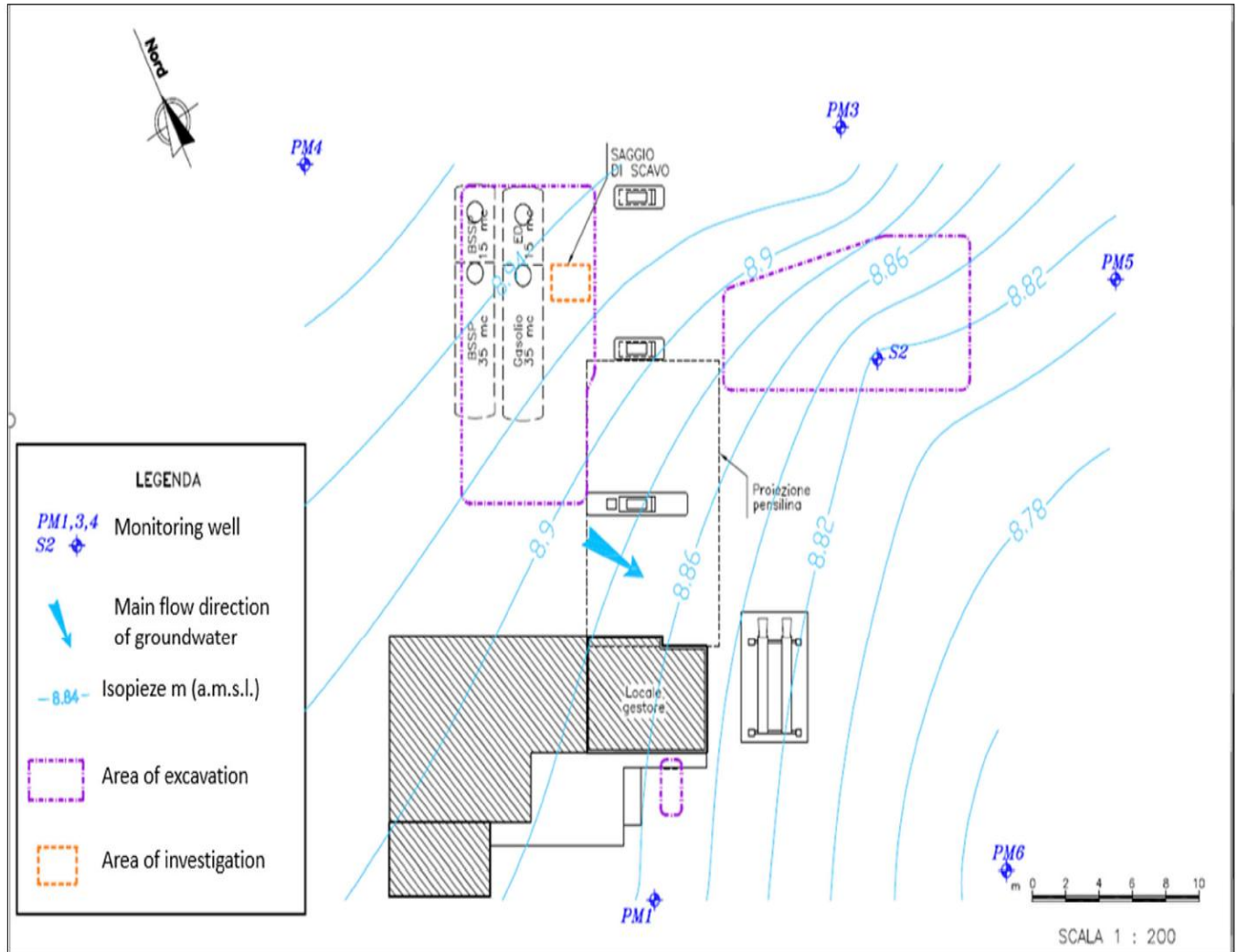



2.3 Contaminants of concern

The results of the environmental investigations showed the presence of two secondary potential sources of contamination, with exceedances of Italian threshold values (CSC D.Lgs. 152/06 and limits DM31/15):

- the deep soil (exceedance for benzene, ethylbenzene, toluene, xylenes, light hydrocarbons C_{≤12}, heavy hydrocarbons C_{>12}, MtBE);
- groundwater (exceedance for benzene, toluene, p-xylene, total petroleum hydrocarbons, MtBE);
- No LNAPL was detected on Site.

A human health risk assessment was developed for the Site, as required by Law. The assessment showed that the human health risk was acceptable but the Italian Law requires that groundwater contaminants concentration, at the wells located at the Site downgradient boundary, must meet with Italian threshold limits (CSC D.Lgs. 152/06). Some exceedance were detected in those wells, due to the plume generated from the main source area where the former tanks were located, and therefore a groundwater remediation was deemed for the Site. The tables below shows the results of the comparison of the maximum detected concentration and the risk-based site-specific threshold limits (CSR), which are the remediation targets:

- unsaturated deep soil (depth > 1m bgs), no remediation is needed.

Contaminant	Max conc. on Site	Remediation targets	Unit
benzene	163	163	mg/kg SS
ethylbenzene	502	502	mg/kg SS
toluene	648	648	mg/kg SS
xylenes	1,472	1,472	mg/kg SS
light hydrocarbons C _{≤12}	19,509	19,509	mg/kg SS
heavy hydrocarbons C _{>12}	5,742	5,742	mg/kg SS
MtBE	736	736	mg/kg SS

No remediation is needed

- groundwater within the site, no remediation is needed.

Contaminant	Max conc. on Site	Remediation targets	Unit
benzene	46	46	µg/l
toluene	3800	3800	µg/l
p-xylene	2619	2619	µg/l
total hydrocarbons (as n-hexane)	13000	13000	µg/l
MtBE	230	230	µg/l

- groundwater at the boundary of the site remediation is needed

Contaminant	Max conc. on Site	Remediation targets	Unit
benzene	3.2	1	µg/l
toluene	<0,13	15	µg/l
p-xylene	<0,16	10	µg/l
total hydrocarbons (as n-hexane)	220	350	µg/l
MtBE	230	40	µg/l



2.4 Regulatory framework

The main environmental law in Italy is the Legislative Decree no. 152/2006 (D.Lgs. 152/06) that in Part four, fifth title sets specific rules for remediation of contaminated sites.

Moreover, a specific decree exists for petroleum service stations, Ministerial Decree no. 31/15 (DM31/15), which sets specific simplifications and procedures for those sites. There is no specific legislation for the application of ISCO technology.

The reference legislation establishes some threshold values (CSC D.Lgs. 152/06 and limits DM31/15) for the main contaminants both in soil and groundwater, if during the characterization there are one or more exceedance of threshold values, the site is defined as "potentially contaminated", and a human health risk assessment can be developed to estimate the risks deriving from the potential sources of contamination detected on site (defined by the samples with exceedance) and to calculate risk-based site-specific threshold limits (CSR). The legislature also states which values are of acceptable risk for the assessment.

If the estimated risks are lower than acceptable values, the site is defined as "not contaminated", and no remediation is needed. If the estimated risks are higher than acceptable values, the site is defined "contaminated", and remediation is needed. The risk based site-specific threshold limits (CSR) are the remediation targets.

For the wells located down-gradient site boundary, the Italian Law sets the CSC as targets, and if exceedances are detected, a remediation is required.

5. Full-scale application

5.1 Main Reagent

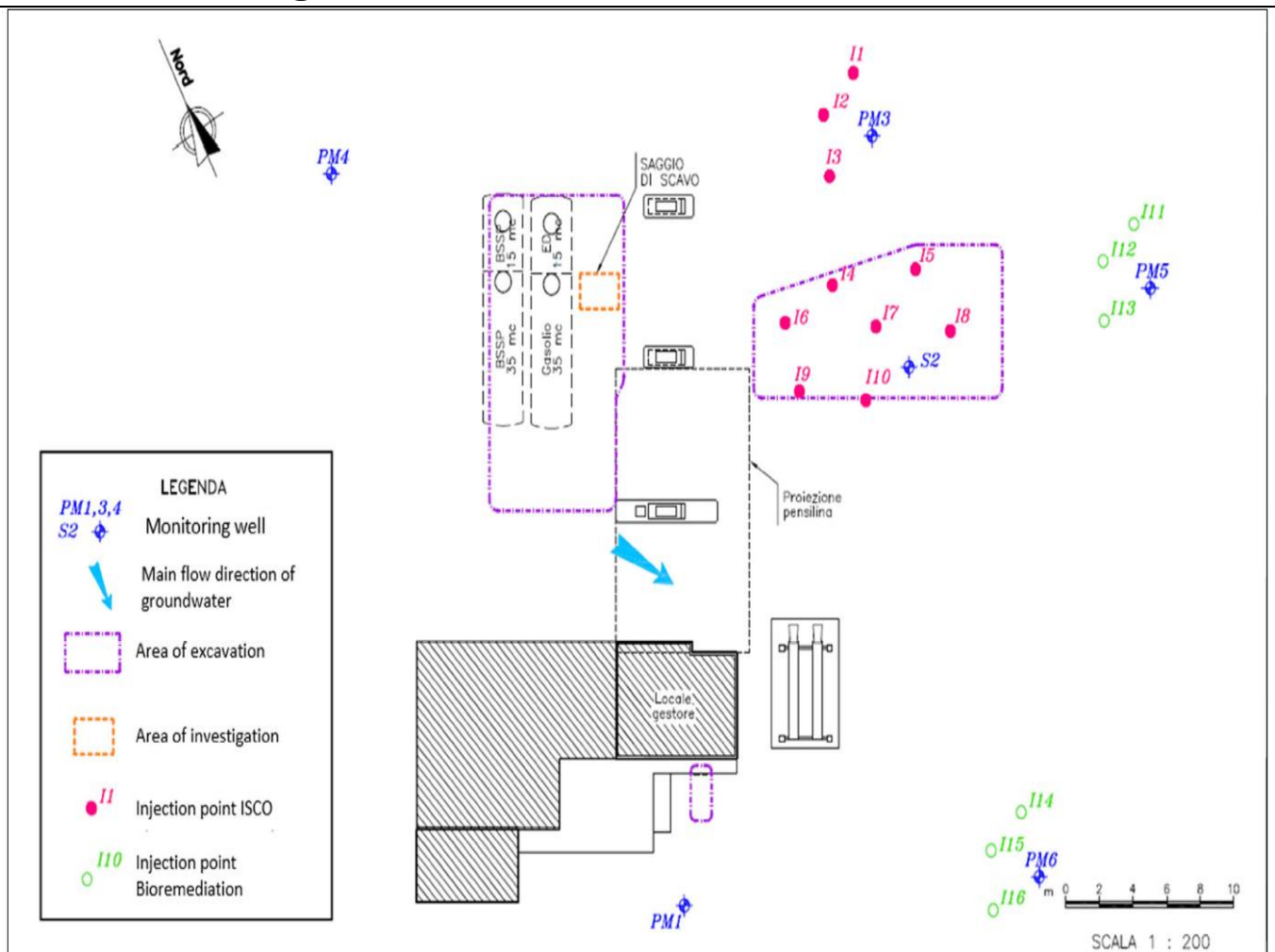

The selected reagent was sodium persulfate ($\text{Na}_2\text{S}_2\text{O}_8$), that needs to be activated to release the persulfate anion and radicals ($\text{S}_2\text{O}_8^{2-}$) in water, which are strong oxidizing agents, successfully applied in similar contexts.

The activation can be performed by several means, in this case study the choice was alkaline activation by adding sodium hydroxide (NaOH).

To accelerate the reduction of the contamination in the boundary wells, it was also chosen to inject an oxygen releasing compound, specifically the calcium peroxide (CaO_2), to enhance bioremediation.

The groundwater remediation was thus conducted by a combination of two technologies:

- ISCO in the main source area (below the old replaced tanks, identified as the



primary source), characterized by higher concentration of contaminants and which generated the plume that extended to the Site boundary. The chosen oxidant was sodium persulfate ($\text{Na}_2\text{S}_2\text{O}_8$), activated by creating an alkaline environment in the groundwater with the addition of sodium hydroxide (NaOH). The oxidant was applied in no. 10 injection points located in the main source area.

- Bioremediation in the area near the Site boundary, invested by the plume generated by the main source and characterized by lower concentration of contaminants. The chosen compound was calcium peroxide (CaO_2). The compound was applied in no. 6 injection points located near the boundary wells that showed exceedance.

The treatment comprised of one single injection event and eventually, after 12 months of groundwater monitoring, a second injection event, to be assessed based on the results of the monitoring campaigns.

The injection points were drilled between March 13 and April 6, 2018, by installation of “manchette tubes” (see paragraph 5.3 for detailed information), while the injection activities took place between May 7 and May 11, 2018, applying the following dosages:

- Main source area, ISCO treatment (injection points I1÷I10): a solution of sodium persulfate, water and sodium hydroxide (as activator) was injected with the following dosages:

Thickness of injection	5	m
Dose of sodium persulfate per point	150	Kg
Slurry of sodium persulfate per point (diluted 15%)	1000	L
Sodium hydroxide diluted 25% per point (as activator)	288	L

- Wells near the boundary, Bioremediation treatment (injection points I11÷I16): a solution of calcium peroxide and water was injected with the following dosages:

Thickness of injection	5	m
Dose of sodium persulfate per point	53	Kg
Slurry of sodium persulfate per point (diluted 20%)	265	L



5.2 Additives

Sodium persulfate ($\text{Na}_2\text{S}_2\text{O}_8$), the selected oxidant for ISCO remediation in the main source area, needs an activator that allows its decomposition in persulfate anions and radicals ($\text{S}_2\text{O}_8^{2-}$), which are strong oxidizing agents. The chosen activator was sodium hydroxide (NaOH) at 25% concentration, able to create an alkaline environment in groundwater.

Sodium persulfate activated with alkaline environment was applied successfully in similar contexts.

5.3 Injection type

To perform the injection no. 16 new injection points were introduced on site, by drilling and installing no. 16 manchette tubes, with valves located every 50 cm between 10 and 15 m bgs, which is the saturated zone to be treated.

In the main source area no. 10 injection points were installed following an orthogonal grid to the main direction of flow separated by a distance between 3 and 5 m.

While in the area near the Site boundary no. 3 injection points with interdistance between of the injection of approximately 3 m were installed upstream each of the two impacted well (n. 6 points in total). As mentioned before the treatment comprised one single injection event and eventually, after 12 months of groundwater monitoring, a second injection event, to be assessed based on the results of the monitoring campaigns.

The injection points were drilled between March 13 and April 6, 2018, by the installation of "manchette tubes", while the injection activities took place between May 7 and May 11, 2018.

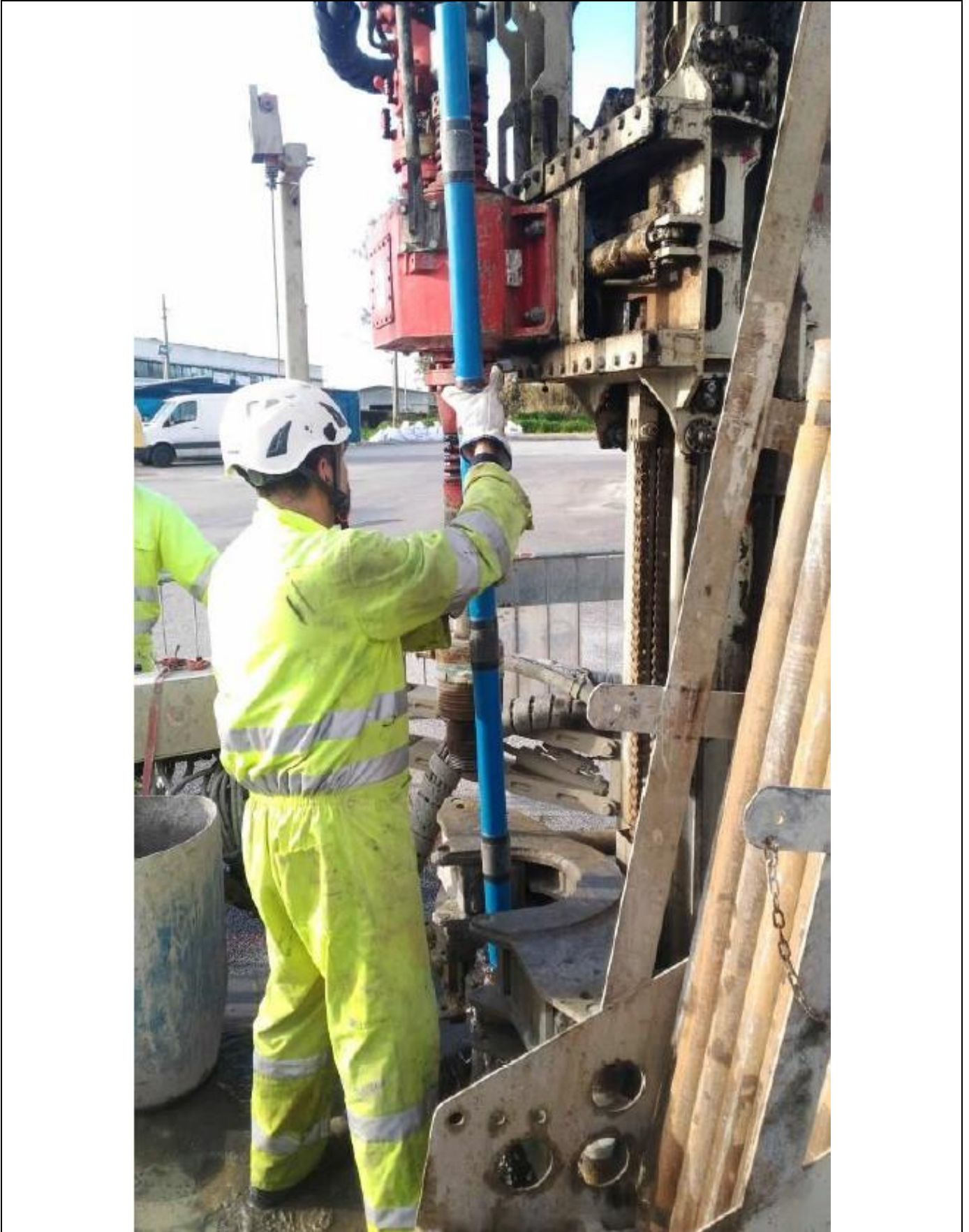



5.4 Radius of influence

Radius of influence estimated for the geology found on Site (medium-fine sands) is about 3 m.

5.5 Process and performance monitoring

The monitoring of the remediation lasted one year following the schedule below:

- Before the injection (December, 2017):
 - first monitoring campaign, with groundwater sampling and measurement of physic-chemical parameters in all monitoring wells, to be used as an initial value (t0) to verify the progress of the treatment;
- Injection as illustrated in paragraphs 5.1 and 5.3 (May, 2018);
- During the first three months after the injection (June, July and August, 2018):
 - monthly monitoring of all monitoring wells, with sampling of groundwater and measurement of chemical-physical parameters;
- From the fourth to the twelfth month after the injection (November, 2018, February and May, 2019):
 - quarterly monitoring of all monitoring wells, with sampling of groundwater and measurement of physic-chemical parameters;

The physic-chemical parameters measured using a multiparameter portable probe were the following:

- temperature;
- redox potential;
- pH;
- electrical conductivity;
- dissolved oxygen.

The samples collected from the wells were chemically analyzed to determine the concentration of the following parameters:

Parameter	Method
BTEX+S	EPA 5030C 2003 + EPA 8260D 2018
total hydrocarbons (as n-hexane)	ISPRA Man 123 2015 - Metodo A+B
MtBE	EPA 5030C 2003 + EPA 8260D 2018
Sulphates	UNI EN ISO 10304-1:2009
Nitrates	UNI EN ISO 10304-1:2009

The last monitoring campaign was supervised by the local authorities who sampled the wells located at the boundary, validating the results obtained.

The remediation was completed successfully in the estimated time and one single injection event.

Based on the results the second injection events was not undertaken. Since both the Authority's and project manager results met remediation targets, the remediation process was certified as being concluded.

In the charts below is shown the contamination reduction obtained in S2, located in the main source area and in PM5 and PM6, both located at the boundary:

Monitoring well "S2"

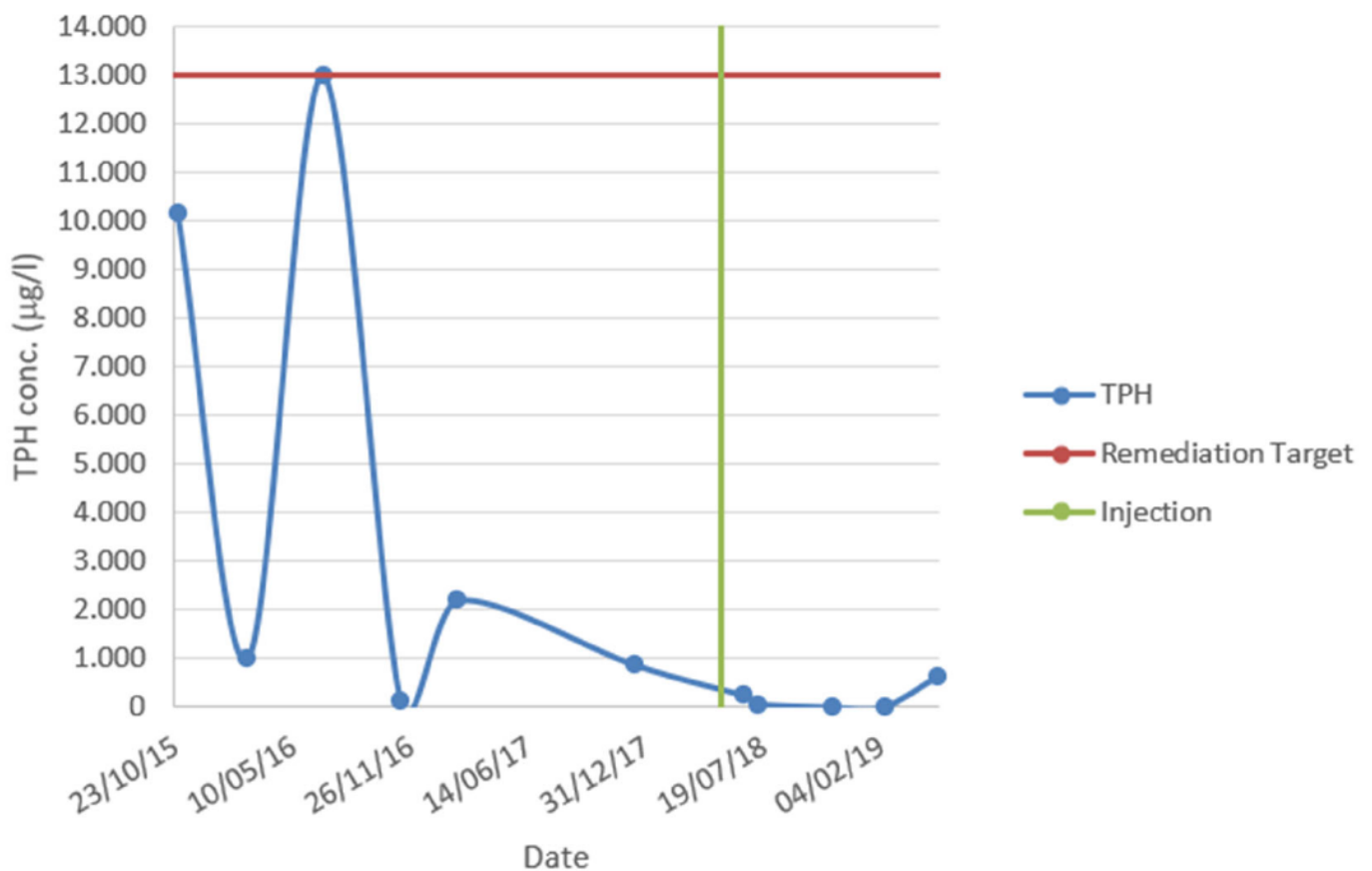

Monitoring well "S2"

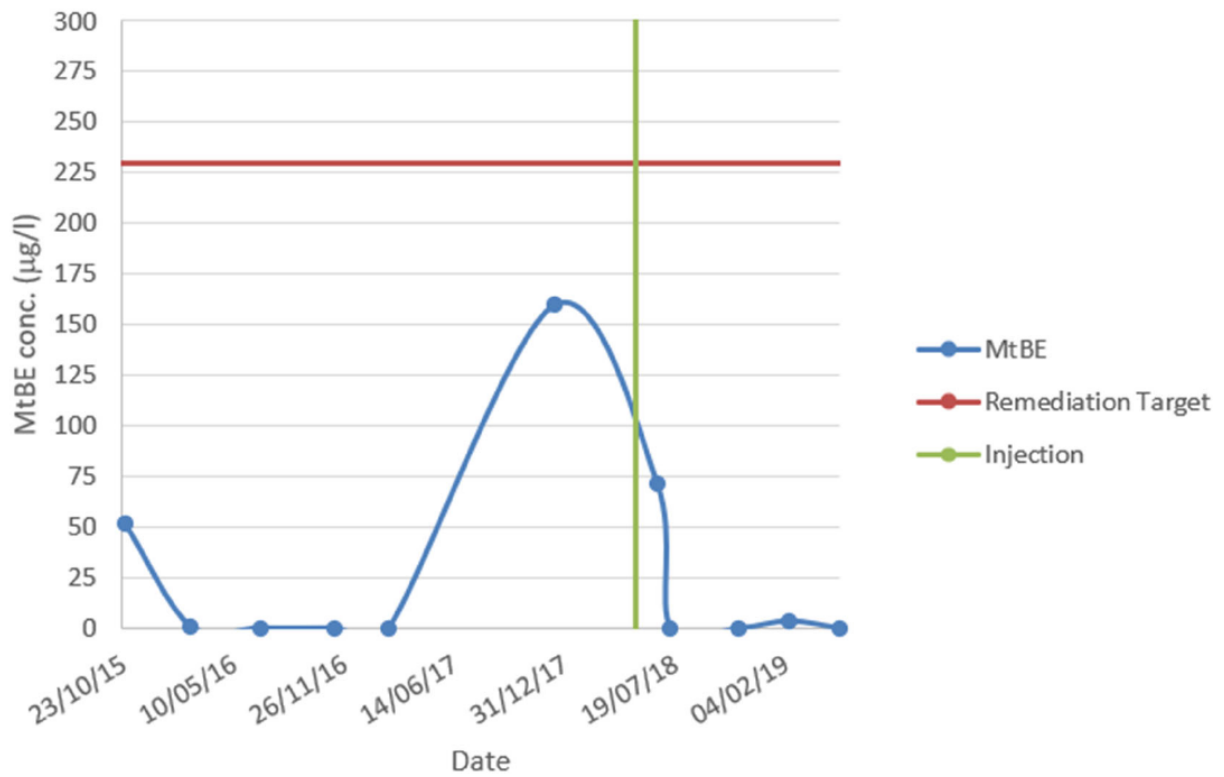

Monitoring well "PM5"

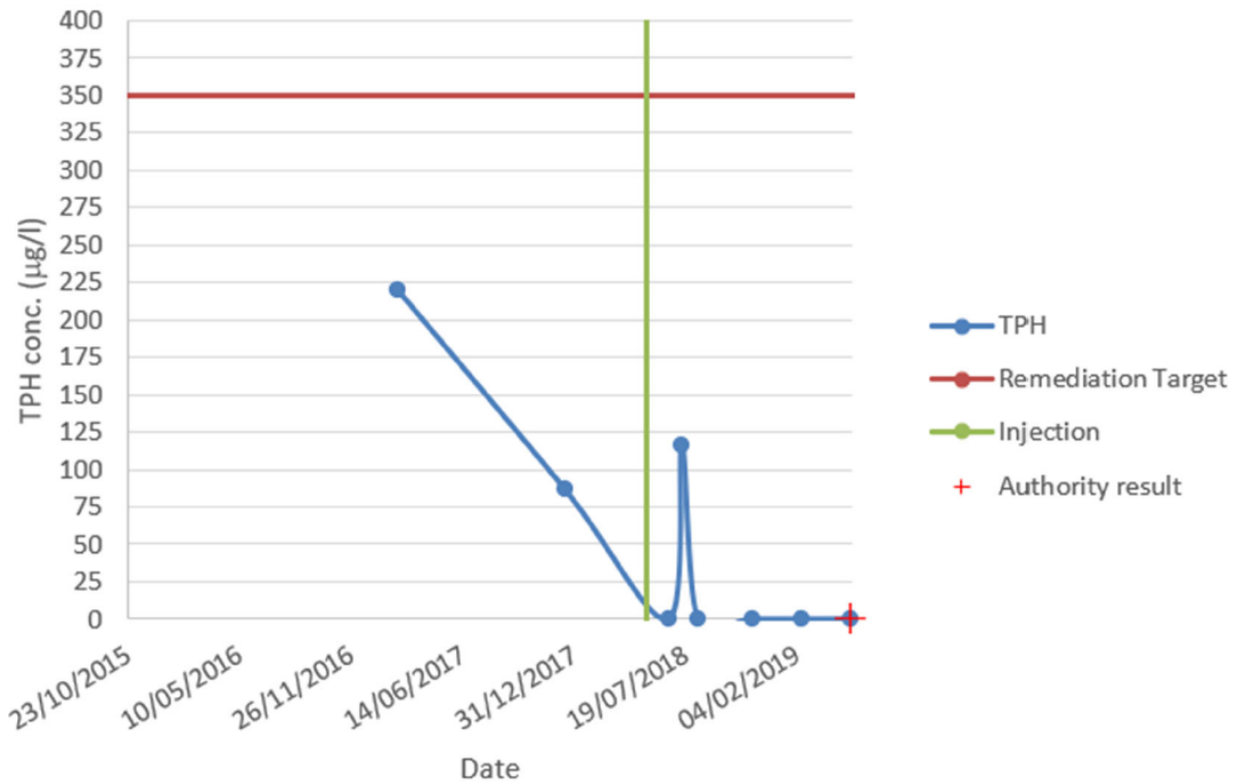

Monitoring well "PM5"

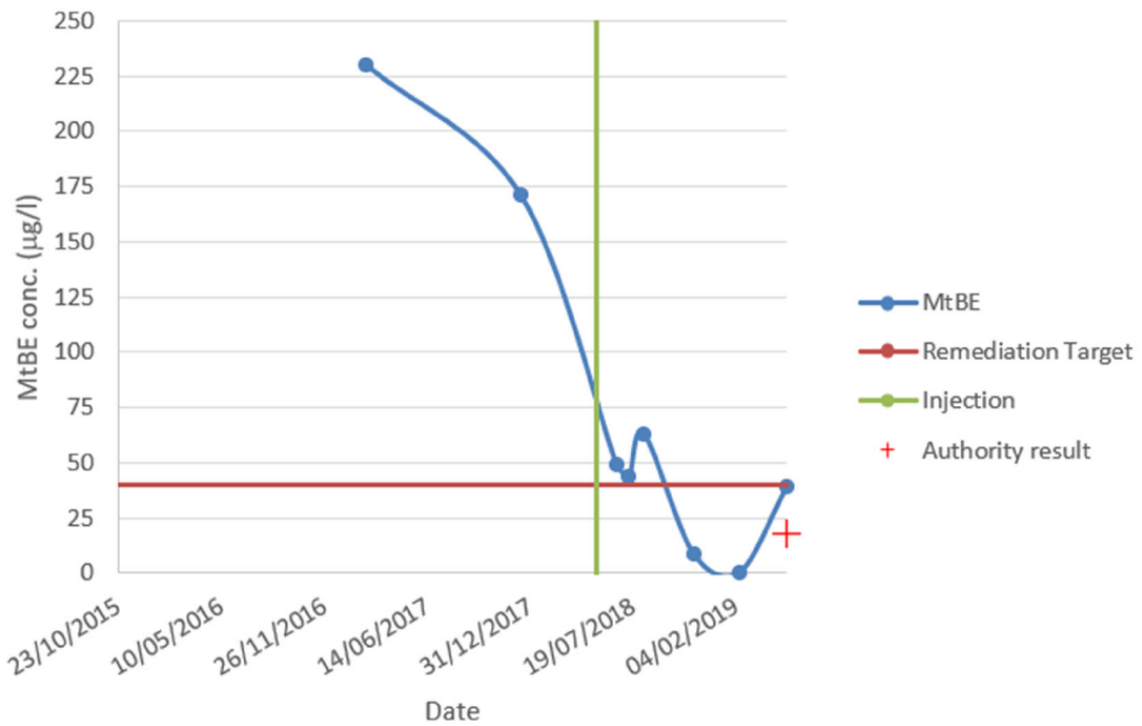

Monitoring well "PM6"

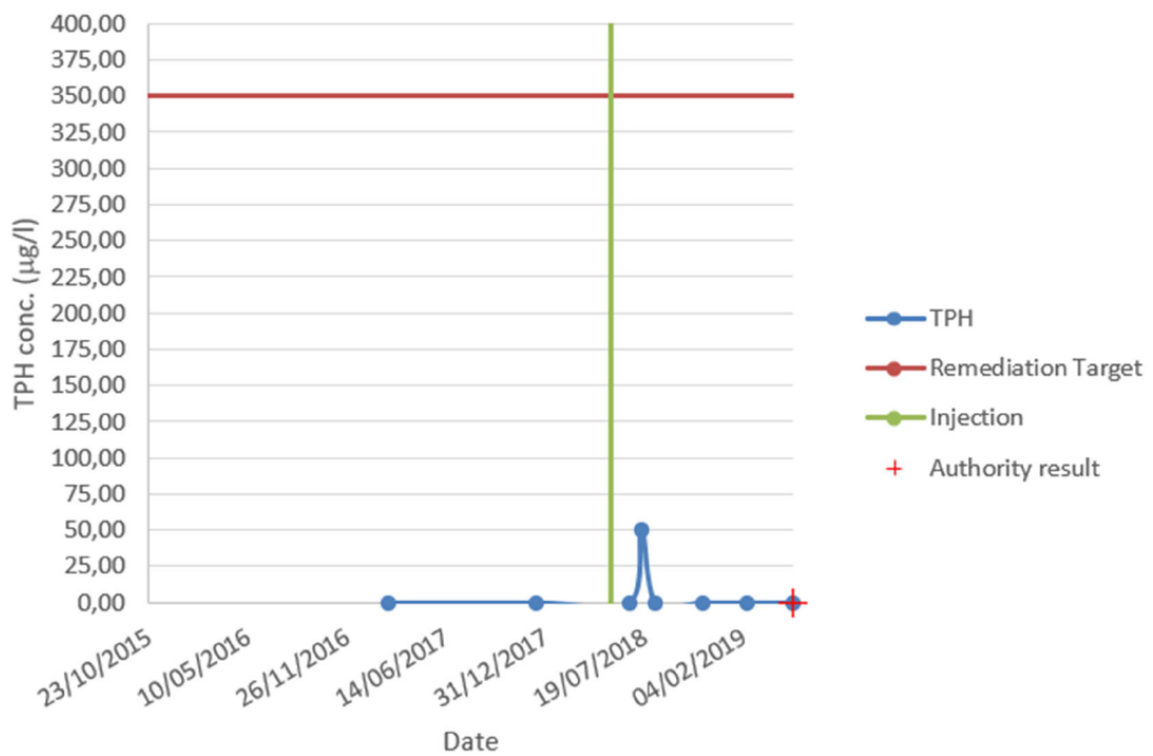

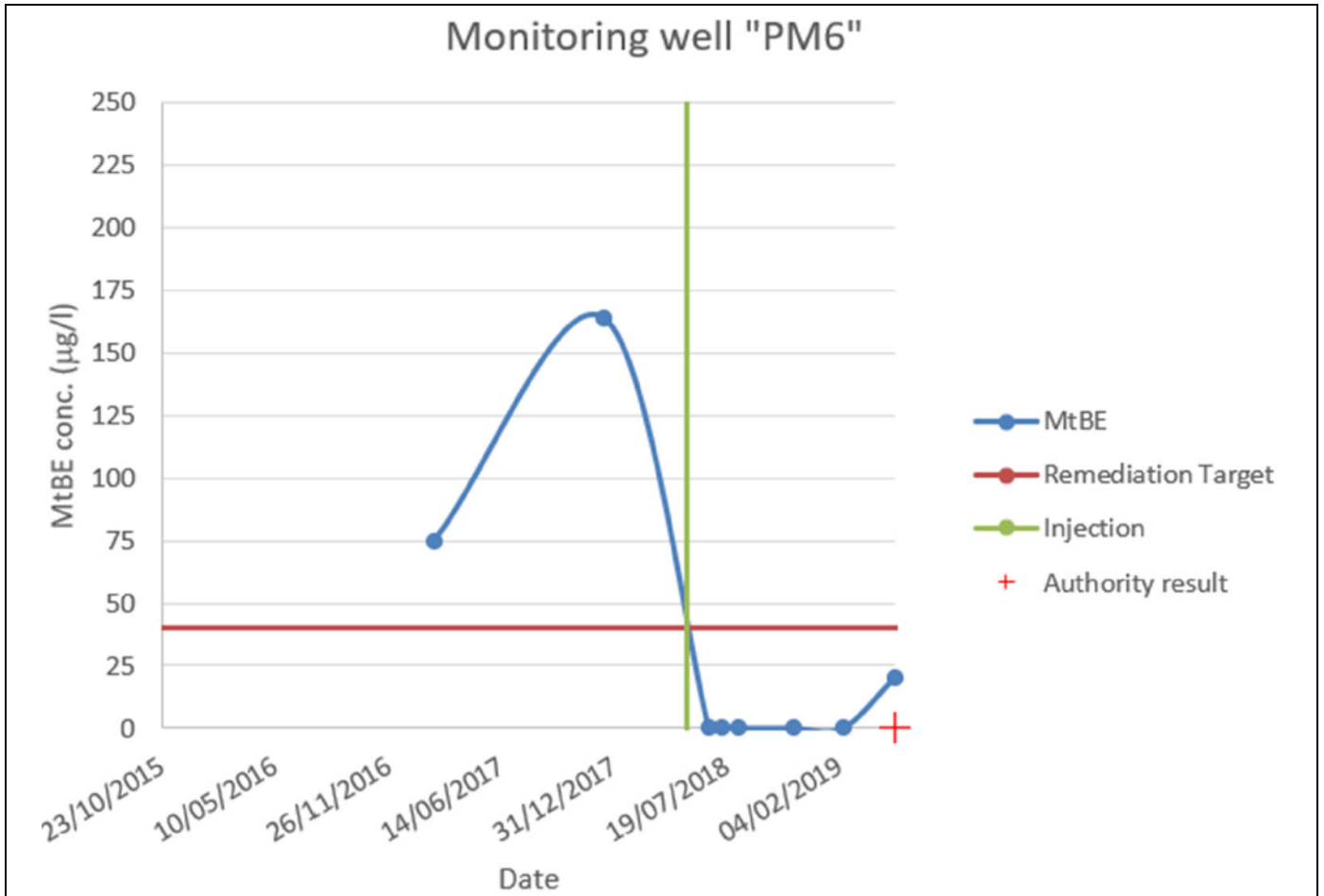

1. Contact details - CASE STUDY: ISCO n.10

1.1 Name and Surname	Christelle Tarchalski
1.2 Country/Jurisdiction	France
1.3 Organisation	ARTELIA
1.4 Position	Hydrogeology team manager / Project Manager
1.5 Duties	Contaminated land (from the desk study phase all the way to the reception of the rehabilitation works) & hydrogeology (water resource management and geothermal studies)
1.6 Email address	Christelle.tarchalski@arteliagroup.com
1.7 Phone number	+33 6 27 70 70 94



2. Site background

2.1 History of the site: Challenges and Solution

- Former petrol station which had been dismantled and is in the process of ceasing activities
- Impact of soil and groundwater due to an incident – release of hydrocarbons
- Preliminary remediation works on the unsaturated zone using digging techniques and on-site treatment with biopile and landfarming
- Identification of residual impacts around the groundwater table which were not accessible using excavation techniques (close to site boundaries / Soil stability)
- Implementation of laboratory testing to identify the best solution and design of the solution based on ISCO technique.
- Implementation of the ISCO technique (one campaign) at the site and reception of the treatment based on soil results after 1 year and monitoring of groundwater and soil gas quality over 2 years after the injection.

2.2 Geological and hydrogeological setting

Geology: 0 to 0.2m – pavement or topsoil; 0.2 to 0.8m – made ground; 0.8 to 5m – clayey silt; 5 to 6m – marl limestone

Groundwater encountered at around 4.15 to 4.50m below ground level

Very low permeability of the clayey silt



2.3 Contaminants of concern

Contaminants of concerns:

- Total petroleum hydrocarbons and BTEX

Concentrations in the soil:

- TPH C5-C10: 250 up to 1,500 mg/kg
- BTEX: 80 up to 820 mg/kg
- And to a lesser extend: TPH C10-C40: 120 up to 3 100 mg/kg (mainly C12 to C21)

Maximum concentrations in the groundwater:

- TPH C5-C10: 52 000 up to 48500 µg/l
- BTEX: 43,000 up to 96980 µg/l
- And to a lesser extend: TPH C10-C40: 780 up to 7920 µg/l

No free-phase products.

No clean up goals –the aim was to improve the quality of the soil regarding residual concentrations of hydrocarbons

Treatment to be focussed on the soil around the groundwater table as the residual impacts are located in this area.

2.4 Regulatory framework

Site into the process of ceasing activities (ICPE)

Guideline for contaminated site of 2017 – remediation of source area: The April 19th 2017 ministerial Note.

Remediation targets for former motorway petrol station were used but there were no regulatory remediation targets as such – these values are defined during a study conducted by a group of petrochemical companies, motorway operators and consultants in order to harmonise practises: “Approche méthodologique harmonisée pour la gestion de stations-services autoroutières – Guide de mise en oeuvre – Décembre 2005 – A37808/C”



3. Laboratory-scale application in field

3.1 Laboratory scale application

Phase 1 – test with different oxidant during 48h

Tests on soil mixed with groundwater samples collected at the site:

- Potassium permanganate
- Sodium persulfate:
 - Activated in alkaline conditions
 - Activated with hydrogen peroxide
- Fenton (hydrogen peroxide catalysed with iron under 3 different forms)
- Concentrations of oxidizing agent selected based on a stoichiometric approach and a SOD test

Total of 6 tests + 1 test as a reference

Following the phase 1, results indicated that the potassium permanganate was the most efficient and therefore selected for the phase 2.

Phase 2 – assessment of the concentrations and the dosage of the oxidizing agent :

- Total of 4 tests: 2 doses x 2 concentrations during 48h

Results indicated that a high dose and a high concentration were optimal, especially on BTEX and C5-C10.

In phase 1 and 2, monitoring was conducted before and after the test – each jar was analysed for TPH C5-C10, TPH C10-C40 and BTEX.

In phase 2 colorimetric tests were also conducted at the end of the test.



4. Pilot-scale application in field

No pilot scale application in the field due the small size of the area to be treated

5. Full-scale application

5.1 Main Reagent

The oxidizing agent was injected into the ground between 3.5 and 8m bgl using direct push technique (Geoprobe).

The injection was conducted in 2 successive phase:

- Phase 1: injection across all the impacted area: each injection point was around 1 apart (the radius of influence was estimated around 1m due to the low permeability of the soil – this hypothesis was checked and confirmed at the beginning of the injection)
- Phase 2: injection in-between the injection points of the Phase 1 in the most contaminated area

The works for conducted over a period of 3 weeks.

Total of 83 injection points (over around 200m²) and of approximately 25m³ of sodium permanganate at 20%.

Injection points were placed using a grid on a plan and in a staggered arrangement.

The injection pressure was at the maximum of around 2 to 4 bars.

5.5 Process and performance monitoring

- Soil boring was conducted regularly to confirm the radius of influence of the injection points and that the oxidizing agent was diffusing homogeneously over the length of the injection (between around 4 and 8m bgl) – controls were done visually as the permanganate has a violet colour.
- Groundwater in the piezometer at and around the treated area were also controlled – visual control as the permanganate has a violet colour and in the laboratory to measure the percentage of remaining oxidizing agent and to analyse TPH and BTEX.



6. Post treatment and/or Long Term Monitoring

6.1 Post treatment and/or Long Term Monitoring

Monitoring of groundwater and soil gas over 2 years after the injection.

As soon as the colouration had disappeared, groundwater samples were tested for TPH C5-C10, TPH C10-C40

After 12 months, soil samples were taken from the treated area – results indicated a real improvement in soil quality. Soil results were used as an indicator for defining the success of the treatment.

Results indicated a reduction of 65% of the mass of the contaminants of concern.

7. Additional information

7.1 Lesson learnt

- In soil of low permeability, the colour may be retained for a longer period of time in the ground, however, often at very low percentage – colorimetric tests are a very simple and good approach.
- In low permeability soil, the time for the ground/groundwater to find a new equilibrium after the injection can be very long (up to 24 months)

7.2 Additional information

- Chemical processes / molecules are relatively well-known.
- A key success factor is the understanding of geological and hydrogeological conditions at the site and to some extent the geochemical conditions. This is the first things to consider when thinking about techniques to use and coming up with the best strategy for treating the impacted area.
- You have to control the volume/quantity of oxidizing agent that you are storing on the site during the treatment – storing too much oxidizing agent may demand that you obtain a permit for doing so.

7.3 Training need



- Workshops are a good approach to exchange experiences and get the basic knowledge and tools to be able to face real situation
- On the job training to allow people to be confronted to real situation – as there is a gap between the theory (what we can read in books and hear from others) and what is really happening in the field.

Glossary of Terms

Term (alphabetical order)	Definition
BTEX	Benzene, toluene, ethylbenzene and xylenes
TPH	Total petroleum hydrocarbons
M bgl	Meter below ground level

1. Contact details - CASE STUDY: ISCO n.11

1.1 Name and Surname	Harald Opdam
1.2 Country/Jurisdiction	The Netherlands
1.3 Organisation	Heijmans Infra BV
1.4 Position	Lead Engineer
1.5 Duties	
1.6 Email address	hopdam@heijmans.nl
1.7 Phone number	+31 (0)73 543 59 00

2. Site background

2.1 History of the site: Challenges and Solution

For several years, a manufacturing facility was in operation at a location near the city center of Uden, Netherlands. As a result of business activities at the site, soil and groundwater have been impacted with chlorinated hydrocarbons. Following demolition of the buildings in 2005, site investigations revealed high levels of contamination. In the groundwater aquifer, concentrations of more than 16,000 $\mu\text{g/l}$ of trichloroethylene (TRI) were measured, indicating the presence of a source zone (SZ). The impacted SZ is 270 m^2 and contaminated in the saturated zone from 3.0 to 7.0 meters below ground level. For the planned redevelopment of the site into a residential area, the local regulatory authorities mandated remediation of the contaminations to stringent clean-up target levels.



Site overview and location source zone

Following detailed Site Investigations (SI), as per standard operating procedures the first step was excavation of contaminated soils to the top of the groundwater level, and then backfilling the area with certificated clean soils. In view that the envisioned end-use by a real estate developer following the land transaction was construction of residential housing, rapid remedial results were required. As elements of the Remedial Options Appraisal (ROA) process, selection of a technological solution required high reliability, cost-effective implementation and quick results as key objectives. The engineering consultants conducted the SI and were involved with results verification, whereas the lead contractor was responsible for overall project management including technology selection, remediation design and implementation.

2.2 Geological and hydrogeological setting

The site is located in between two geological shear zones (Peelrandbreuk en Raambreuk) which mark the transition from the higher Peelhorst area (+20 meter above sea level) tot the lower Roerdalslenk area (+10 meter above sea level).

The surface level at the location is about +16.5 meter above sea level (masl). The groundwater table is located at 3.0 meters below surface (mbs). The groundwater flow is in south-west direction with a hydraulic gradient of 0,002 m/m.



Drill core borehole (sonic drill)

Below the groundwater table until a depth of 16 mbs the site consists of medium fine to coarse sand. Locally some gravel layers and silty clay are present. The fraction organic carbon (Foc) is less than 0.5 %. The hydraulic conductivity varies between 2 and 20 m/day and the effective porosity is about 27.5%.

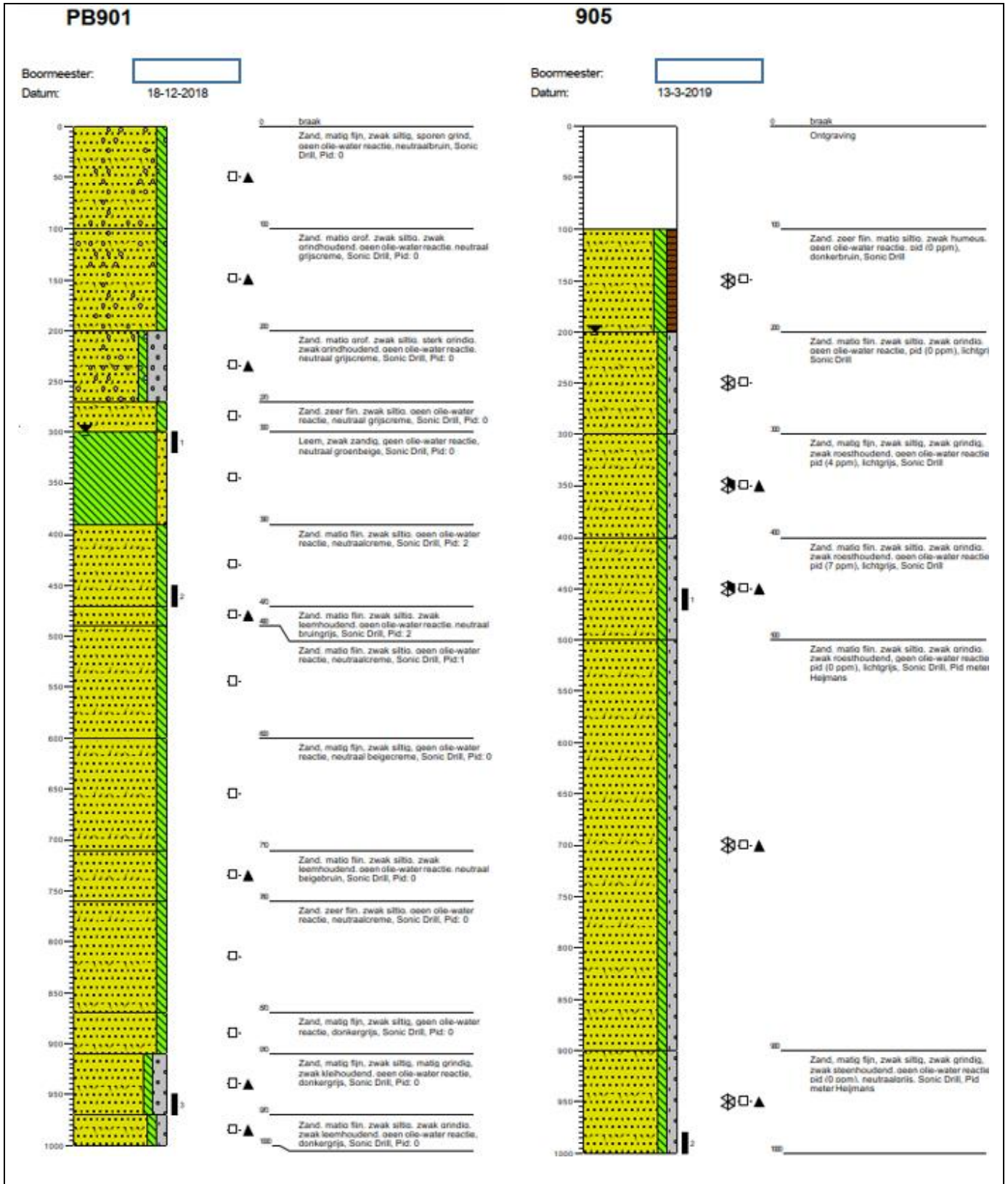

2.3 Contaminants of concern

The contaminants of concern are chlorinated solvents, especially trichloroethylene (TRI). Concentrations of more than 16,000 $\mu\text{g/l}$ of trichloroethylene (TRI) were measured in the saturated zone.

In the unsaturated zone more than 16,000 mg/kg of TRI was present.

A NAPL is not demonstrated and the soil contamination in the saturated zone is negligible.





2.4 Regulatory framework

The quality of the top 1 meter has to meet the standards for Maximale waarde Wonen (MWW). In the subsurface there should be a substantial removal of contamination in order to create a stable groundwater plume. Therefore the remediation goal for the saturated source zone is as follows:

Contaminant	Target value [mg/kg]	Target value [µg/l]
TRI	0,5	2500
CIS	-	1000
VC	-	450

3. Laboratory-scale application in field

3.1 Laboratory scale application

The ISCO-remediation design was based on expert judgement. There was no time available to perform a batch test.

The Foc was assumed to be less than 0.5%.

The soil oxidant demand was assumed to be 3.0 g Persulfate/kg soil. Together with the amount of oxidant needed for the pollution, this resulted in an amount of 9,225 kg Persulfate (Klozur One) for the total source zone (safety factor 1.5).

4. Pilot-scale application in field

4.1 Main treatment strategy

The Klozur® One ISCO technology was selected primarily because it met all ROA objectives. The blend of sodium persulfate with built-in activation chemistry provided powerful oxidation capacity as a “ready to use” product suitable for this highly contaminated treatment area. A total of 9,225 Kg was required, delivered in 25 kg bags from a nearby warehouse, helping to keep the logistics carbon footprint low. As persulfate requires careful handling, the contractor took all necessary safety measures for storage and handling. Factors such as fire safety and unpredictable summer weather also played a role. From the storage facility the product was transported to an onsite mixing facility. There the bags were opened under controlled conditions, ensuring little physical contact between field technicians and the sodium persulfate. Special attention was focused on reducing the production of any dust particles.



The injections were made per batch, and in the injection plan there are several different concentration batches provided. A typical batch contained 4 m³ of clean water into which a specified amount of Klozur One was added. From the mixing unit, the proper solution of Klozur One is transferred into the injection tank.

Volgorde aanmaak	Batch Volume [Liter]	Batch Aantal [n]	Klozure-One [kg/batch]	Aantal zakken [25 kg]	Batch conc. [g/l]	Volume per Filter [Liter]	Filters
1	3700	3,00	350	14	94,6	2775	D1, D2, D3, D4
2	4500	4,80	200	8	44,4	3600	M1, M3, M7, M10, M11, M15
3	4500	4,00	200	8	44,4	3600	M2, M4, M8, M13, M14
4	4500	6,00	200	8	44,4	4500	O1, O3, O7, O10, O14, O116
5	4500	6,00	200	8	44,4	4500	O2, O4, O6, O11, O13, O15
6	3600	4,00	350	14	97,2	3600	M5, M6, M9, M12
7	4500	4,00	425	17	94,4	4500	O5, O8, O9, O12
8	4000	4,50	200	8	50,0	3600	M16, M17, M18, M19, M20

Klozur One batching scheme

As each batch of injectable solution is mixed together, it is then applied to the subsurface through existing injection wells. In total, the contractor used 40 injection points at three different subsurface levels, in a grid pattern with a center-to-center distance of 5 meters (ROI of 2.5 meter)

With this grid, it was possible to engineer contact across the entire source area. At spots with higher concentrations of contaminant, more solution was applied with a higher concentration of persulfate. At each injection points between 2,775 and 4,500 liters of solution were applied. Through use of a manifold system, 4 to 6 wells were worked simultaneously, using a little overpressure to prevent blow-out at the surface. The sequence of the injections was performed from outside to inside located filters. In total, the field works lasted nine days to inject 155 m³ injection fluid of sodium persulfate.



Overview injection filters in source zone



Detail injection well manifold

Results

Before the initiation of the injections there was an investigation of the TRI concentrations onsite. Monitoring activities during and after the injections including measurements of pH, oxygen, redox and electrical conductivity. Following the injections with sodium persulfate, there was a notable decrease in pH and increase in electrical conductivity visible. The contractor used Klozur Field Test Kits to determine an indication of the amount of active sodium persulfate still available.



Klozur Field test kits

The parameters were monitored weekly. After four weeks most of the active sodium persulfate was consumed, allowing the monitoring wells to be used for groundwater quality. In total, monitoring was conducted through 10 wells and in all of them the TRI concentration was decreased to below remediation targets. Four weeks later, an independent verification by the engineering consultants confirmed the positive results. They also concluded that there was no active sodium persulfate left and that the trichloroethylene was sufficiently removed.

Monitoring well 2 depth: 4,5 m below ground level	Parameter		06-09-2019	24-09-2019	21-10-2019	21-11-2019
	PER	µg/l	<50	<1	<1	<1
TRI	µg/l	14.000	2,4	<1	<1	<1
CIS	µg/l	<50	1,4	1,4	1,4	1,4
VC	µg/l	<100	<2	<2	<2	<2
Sodium	mg/l	13	n.a.	3.900	2.600	2.600
Sulfate	mg/l	30	n.a.	1.300	1.400	1.400

Analysis overview of MW2 as representative data

In total the chemical oxidation removed 99.6% of the TRI pollution. With this good result we were able to close the active remediation phase.

4.3 Injection type

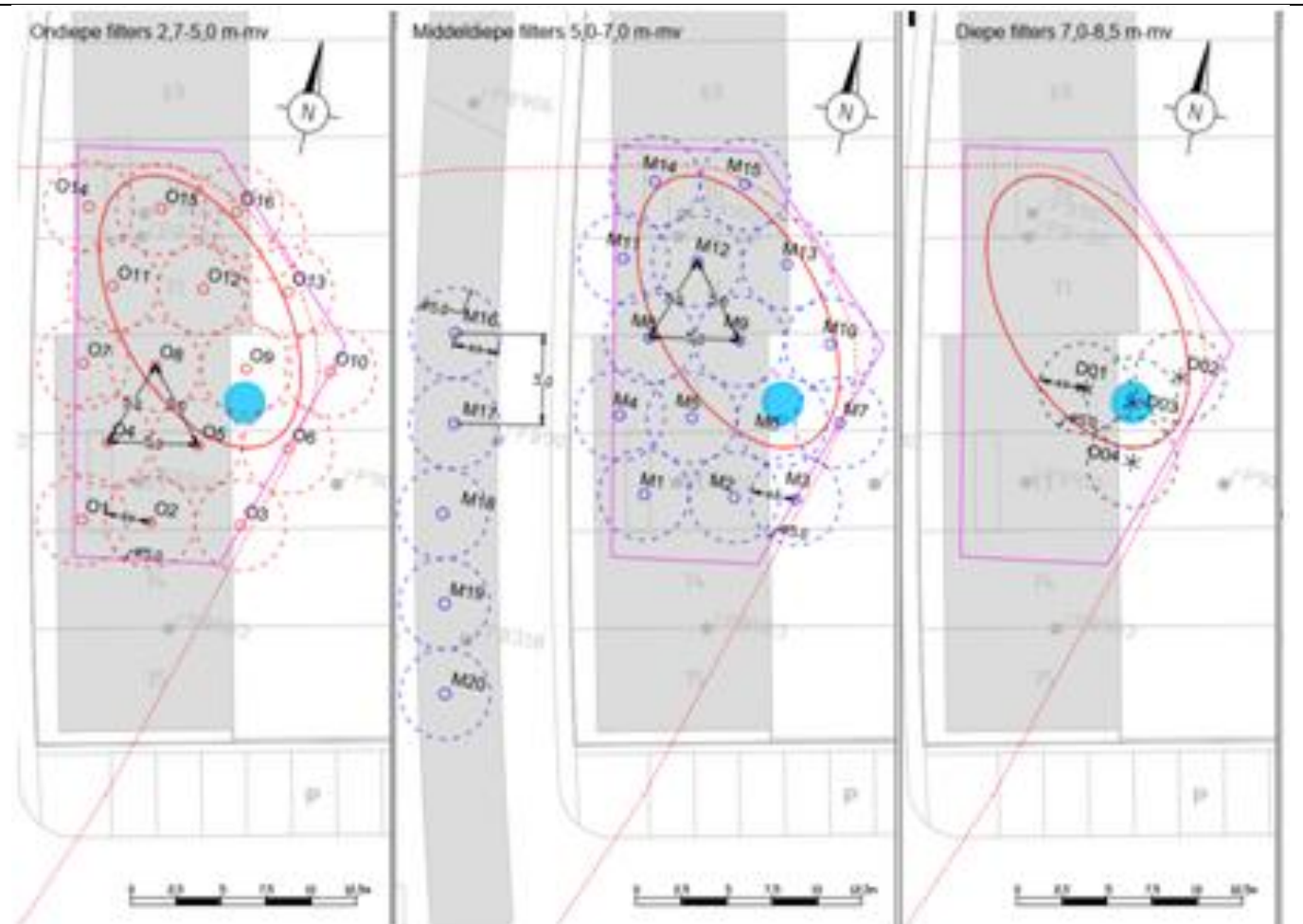

Within the source zone area of 270 m² a total of 35 injection wells were installed. The

injection wells in the source zone were spaced in grid formation with a distance of 5.0 meter. Downstream the source zone another 5 injection wells were installed in barrier formation. For the injection we installed new fixed injection wells with a diameter of $\varnothing 50$ and a screened length of 2 meter.

The injection wells were installed with a screened interval 2.7-5.0 mbs, 5.0-7.0 mbs and 7.0-8.5 mbs. In order to prevent preferential flow or blow-outs every injection filter had a fixed clay-stop was grouted with cement/bentonite up to the surface.



With this grid, it was possible to engineer contact across the entire source area. At spots with higher concentrations of contaminant, more solution was applied with a higher concentration of persulfate. At each injection points between 2,775 and 4,500 liters of solution were applied. Through use of a manifold system, 4 to 6 wells were worked simultaneously, using a little overpressure to prevent blow-out at the surface. The sequence of the injections was performed from outside to inside located filters. In total, the field works lasted nine days to inject 155 m^3 injection fluid of sodium persulfate.

4.4 Radius of influence

The radius of influence (ROI) was based on expert judgement. The actual injection radius of influence is monitored during the first injections. In this way, the ROI and the amount of injection volume for each injection filter was validated in the field.

7. Injection design		
	Lengte	22 m
	Breedte	12,5 m
	Permeability	5 m/day
	Vw	0,91 m/month
	Interval	1 month
		0,91 m
	h.o.h.	5 m
	Design ROI	2,5 m
	Injection ROI	2,05 m
	Design AOI	19,63 m ²
	Injection ROI	13,14 m ²
	overlap	15%



4.5 Control parameters

Before injection we monitored the natural field conditions in control monitoring wells:

- pH, temperature, dissolved O₂, redox potential, electrical conductivity, Sodium, Sulfate, Chemicals of concern

During injection we monitored the dispersion in the field in monitoring filters:

- pH, temperature, dissolved O₂, redox potential and electrical conductivity,
- injection pressure was monitored on each injection well

After injection we monitored the dispersion and contaminant in monitoring filters:

- pH, temperature, dissolved O₂, redox potential and electrical conductivity,
- Klozur Field Test Kits were used to determine an indication of the amount of active sodium persulfate still available.

The parameters were monitored weekly. After four weeks most of the active sodium persulfate was consumed, allowing the monitoring wells to be used for groundwater quality. In total, monitoring was conducted through 10 wells and in all of them the TRI concentration was decreased to below remediation targets. Four weeks later, an independent verification by the engineering consultants confirmed the positive results.

5. Full-scale application

5.1 Main Reagent

The first injection round of injecting 9,225 kg of activated persulfate Klozur One (155 m³ of solution) proved to be enough to reach the target values. No rebound occurred.

7. Additional information

7.1 Lesson learnt

We had limited time to reach our target values (2 months). As we had a low % of organic matter, we chose to perform a full-scale pilot instead of a laboratory batch test. This way we determined the amount of oxidant needed in the field (first injection round).



Eventually we would have had time to inject a second time, but this wasn't necessary anymore as we reached the target values after the first injection.
This way we have saved time and money.

7.3 Training need

The human safety regulations and creating a safe working process for the operating personnel have to be taken into account when applying this technique.
This includes the whole cycle of storage of the oxidant, handling, dust control, mixing and finally controlled injection.

1. Contact details - CASE STUDY: ISCO n.12

1.1 Name and Surname	Valentina Sammartino Calabrese
1.2 Country/Jurisdiction	Italy
1.3 Organisation	ARPA Campania
1.4 Position	Public servant - expert in site remediation
1.5 Duties	
1.6 Email address	v.sammartino@arpacampania.it
1.7 Phone number	+39 081 2301957

2. Site background

2.1 History of the site: Challenges and Solution

- The site is located in an area of medium population density and of important naturalistic / archaeological value.
- It is part of a former SIN
- The company operates and produces in the defence, aerospace and security sectors.

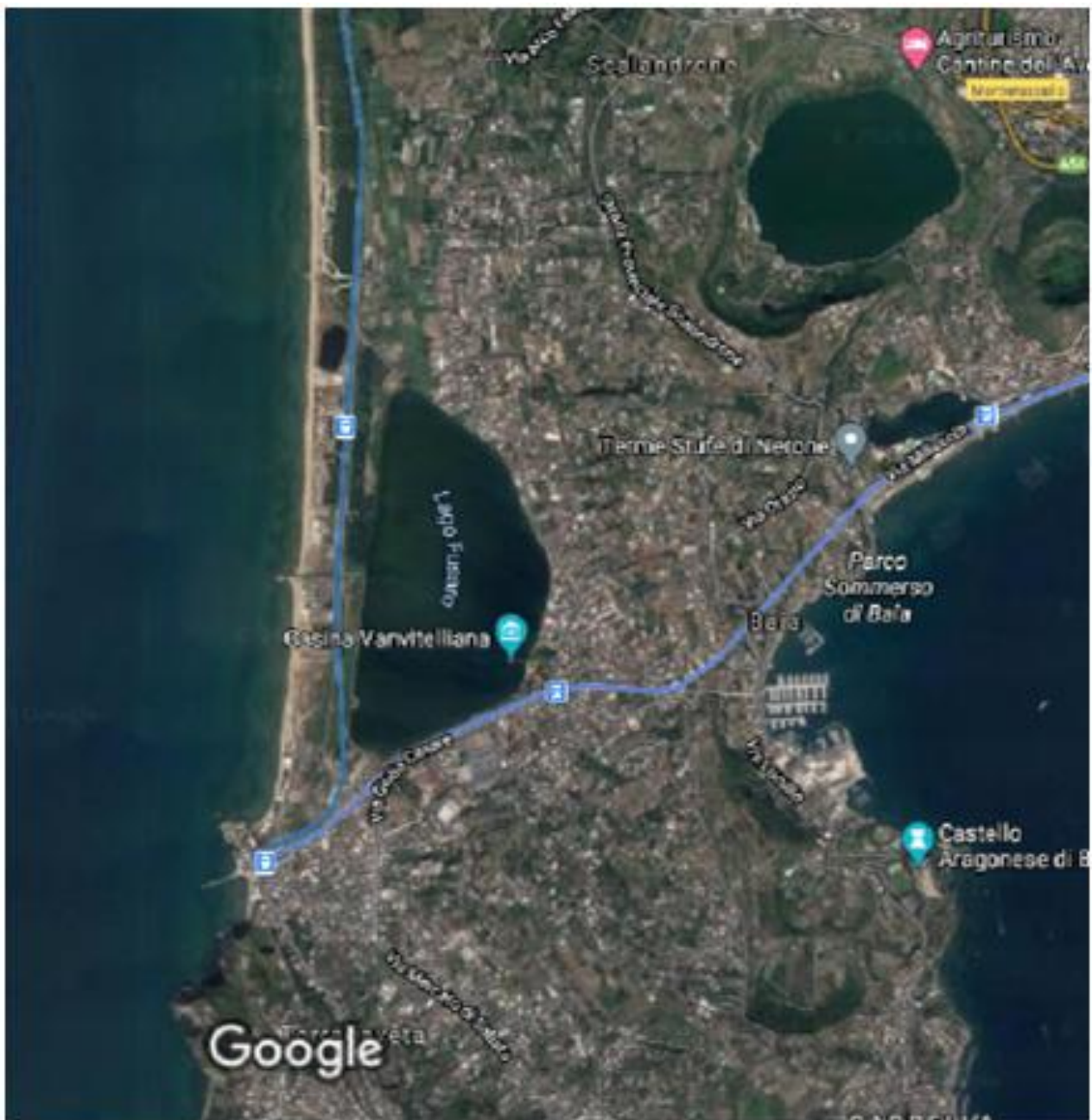



2.2 Geological and hydrogeological setting

In particular in the north-eastern portion of the site, where the ISCO technology was applied, the surface geological structure can be described by the following scheme:

- 0 - 0.60 m: ground floor including the underlying substrate composed of mixed inert material;
- 0.60 - 1.50 m: fill material composed of inert material mixed with a high permeability silty sand matrix;
- 1.50 - 4 m: fine sands, slightly clayey, of fluvio-lacustrine origin, high permeability;
- 4 - 9 m: coarse pumice and gray sands.

The water table has a depth ranging from about 1.5m to about 2 m from the ground level and is located in the alluvial lake deposits.

2.3 Contaminants of concern

- Soils:
 - Hydrocarbons: 3500 mg / Kg
- Groundwater
 - Benzo(a)anthracene: 7.6 µg / L
 - Pyrene: 29 µg / L
 - Benzo(b)fluoranthene: 4.2 µg / L
 - Benzo(g,h,i)perylene: 2.2 µg / L
 - Polycyclic Aromatic Hydrocarbon (PAH sum): 10 µg / L
 - Tetrachlorethylene: 50 µg / L
 - Trichloroethylene: 5.4 µg / L
 - Vinyl chloride: 4.1 µg / L
 - Benzene: 27 µg / L
 - Xylene: 133 µg / L
 - Toluene: 22 µg / L

2.4 Regulatory framework

National Regulations (D.Lgs. 152/2006)



3. Laboratory-scale application in field

3.1 Laboratory scale application

Scope of lab test:

- determine the amount of oxidizing reagent (SOD), for the two different oxidizing compounds tested (sodium permanganate or percarbonate), necessary for the oxidation of organic and inorganic pollutants present in the solid, liquid phase and in the saturated biphasic mixture.
- verify the reduction of pollutant concentrations using different stoichiometric ratios with respect to the SOD determined for each of the two oxidizers analyzed.

2. Lab scale test description:

The SOD determination tests were performed by preparing, for each reagent tested, 5 test tubes each containing an aliquot of 10 g of soil, kept stirred at 120 rpm at room temperature. The reagent solutions were added to the test tubes at three different concentrations. In order to verify reproducibility, the tests were performed in duplicate for each sample.

Reagent quantities for each test tube were calculated on the basis of samples TOC content and of similar experiences reported in the literature.

In total 6 tests were performed in duplicate at different stoichiometric ratios. The liquid / solid ratio used, based on literature reference data, was 3: 5.

During each test, lasting 8 days, the residual oxidant content was determined on a daily basis: for permanganate by means of a spectrophotometric absorption method at 520 nm, whereas for percarbonate by titration with permanganate. To evaluate the influence of the contamination on SOD, the determination of SOD was also carried out on a clean soil sample with the same procedure. Subsequent to the determination of the SOD, ISCO tests were carried out on soil saturated with groundwater using three different concentrations of oxidant in stoichiometric relation with respect to the SOD (ratios of 1: 1, 1: 3 and 1: 5) for two different times (24h and 72h). Consequently, 4 series of tests were carried out, one of which without the addition of oxidant, to check the quantities of pollutant volatilized in different test conditions.

At the end of these tests, the oxidant residual quantity was determined, and in particular metals, C_{>12} and PAHs were determined in the solid phase, whereas metals and chlorinated solvents were determined in the liquid phase.

The results of the tests conducted showed:

- In regards to the solid fraction: a marked reduction in total hydrocarbons C_{>12}, in



the case of using permanganate, even with a low stoichiometric ratio (1:1). The same efficiency was not achieved by percarbonate. A significant reduction in PAHs in the case of using permanganate with stoichiometric dosages greater than 1:3; the use of permanganate in a stoichiometric ratio 1:1 and percarbonate had instead shown unsatisfactory results.

- With respect to the liquid fraction, the analytical results show: CrVI below the instrumental detection limit after 72h of testing or at the end of the reaction control period, either in the slurry where permanganate was used, and in those where percarbonate has been used; complete oxidation of TCE and PCE when using sodium permanganate.

On the basis of the tests carried out in the laboratory, it has been highlighted the necessity to provide a dosage of reactive, to reduce the pollutants present, much higher than the pure stoichiometric ratio between the moles of oxidant and those of pollutant.

4. Pilot-scale application in field

4.1 Main treatment strategy

The laboratory tests showed that, due to the type of pollutants present, the most performing oxidant is permanganate, with percentages of pollutant reduction ranging from 40-50% up to about 90%.

The test consisted in the controlled injection of a solution consisting of:

- 2000 litres of industrial water
- 207.2 kg of sodium permanganate solution with a 40% concentration, corresponding to approximately 85 kg of permanganate.

The injection of the solution was carried on at a flow rate of about 15 l/min (0.9 m³/h) in order to minimize disturbance to the aquifer and avoid displacement of the contaminated water.



4.3 Injection type

To improve monitoring of the possible reagent downstream by migration, an additional control piezometer and a well (PE) were installed to recover any residual permanganate. Before the pilot scale application, in order to evaluate the migration routes of the injected solution, a test with fluorescein was performed. The test involved the controlled injection of a known volume and concentration solution (4000 liters of groundwater and about 0.4g of fluorescein), followed by monitoring of its propagation on a regular daily basis.

This test showed that despite the significant flow rates, the quantities of fluorescein recovered were equal just to approximately 30% of those injected, thus indicating minimal "migration" of the tracer.

The thickness of the saturated soil involved in the test was approximately 6.5m, from 1.5m up to approximately 8m below ground level. The pilot field consisted of: 1 injection well, 5 wells placed radially around the injection well, at a distance of 3, 5, 7 and 15m (internal control piezometers), and 6 external control piezometers/wells.

4.4 Radius of influence

The observation of the water colour in the piezometers adjacent to the injection point made it feasible to verify the solution distribution in the soil. The distinctive purple colour of the injected oxidant was found in the injection well alone, indicating that the reagent reacted completely before it could migrate downstream. Thus the reaction rate is higher than the rate of oxidant dispersion.

Field tests conducted by injecting an amount of sodium permanganate equal to 86 kg showed a radius of influence of less than 2 m, with a total consumption of the injected reagent over a few days.



4.5 Control parameters

During field monitoring the following measurements were carried out:

- A check of the groundwater colour in all points of the cell for 3 days (72 hours);
- groundwater sampling in all the cell points for analysis of metals (Fe, Mn, Cr (III) and Cr (IV), As), chlorinated solvents, IPA, total hydrocarbons, BTEX and COD, CO₂. During the sampling operations, the chemical-physical parameters were also measured after 1 day (T1), 10 days (T2), and 30 days (T3) from the injection.

The physic-chemical data collected during the sampling phases showed significant variations in the redox potential.

The chemical results showed an average percentage concentration reduction after 24 hours equal to 83%. In the following surveys (carried out after 8 days and after 1 month) the concentrations increased, but did not reach the values measured before the pilot test.

5. Full-scale application

5.1 Main Reagent

The laboratory tests and the pilot test highlighted the requirement for a higher dosage of permanganate than the dosage corresponding to the simple stoichiometric ratio, calculated with reference to SOD.

With permanganate, both the laboratory tests and the pilot field test showed a percentages of pollutant reduction of ranging from 40-50% up to about 90%.

5.3 Injection type

Considering the strong anisotropies, the most suitable and least impacting approach for the activities of the site involved injecting the oxidant mixture through a system of micro-perforations at different depths. In order to prevent reagent migration to the hydraulic barrier, wells had been created a few meters upstream of barrier itself, activated in the case of detection of unreacted permanganate (change of groundwater colour).

Considering the high consumption of oxidizer and the low radius of influence (less than 2m), in order to minimize the injection volumes per single point, 48 perforations were carried out (diameter of 127mm and a maximum depth of 7m) for the injection of the oxidizing compound. The drilling took place with continuous dry core drilling. In every perforation, two 1" PVC pipes were installed at different depths. The perforations were arranged along a regular 4 m side mesh with a thickening in the most impacted area, the distance between two injection points is about 2.5 m. A total of 48 injection clusters were created.

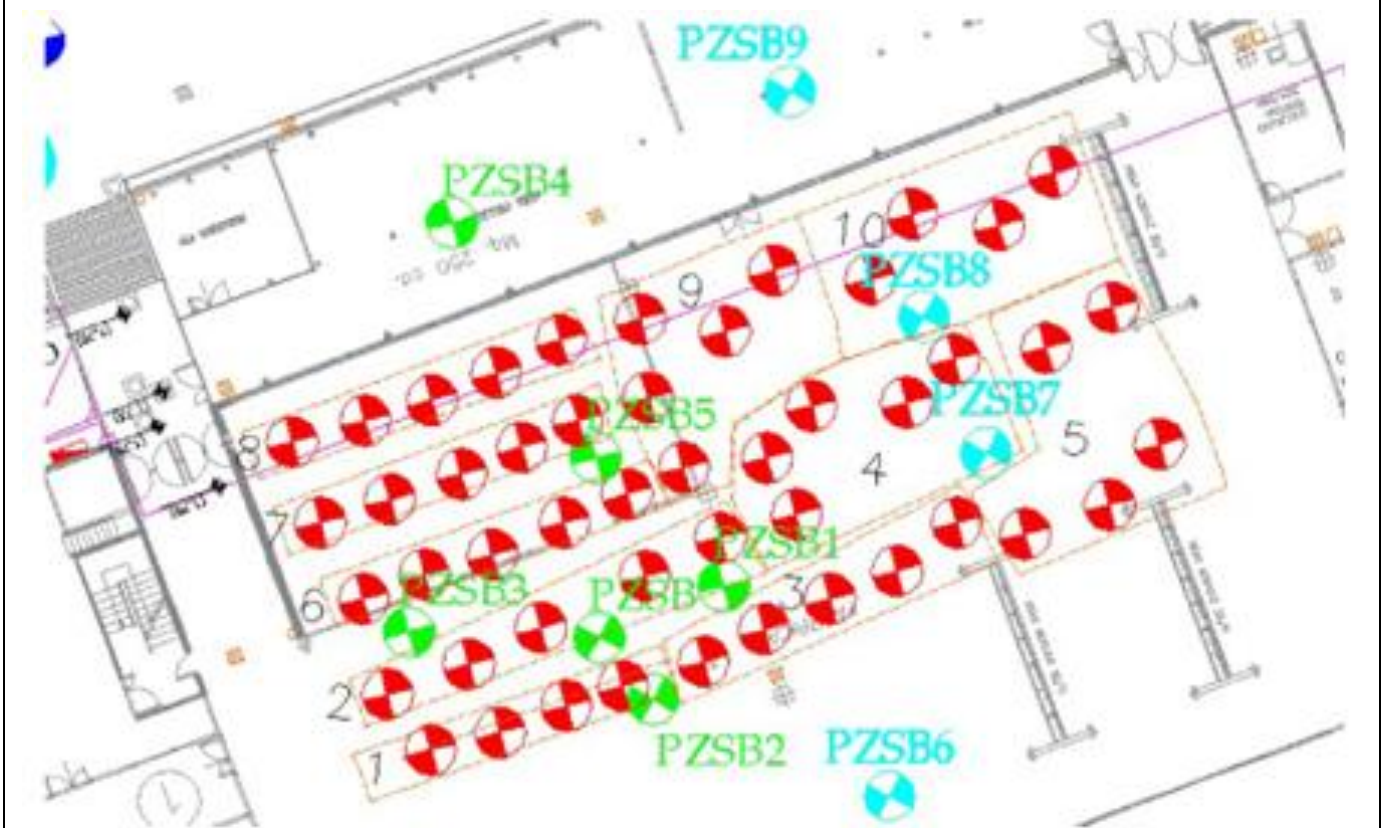

5.4 Radius of influence

Field tests enabled the estimation of a radius of influence of 2m or less with a total consumption of the injected reagent in few days as shown by water colour variation in the injection point.

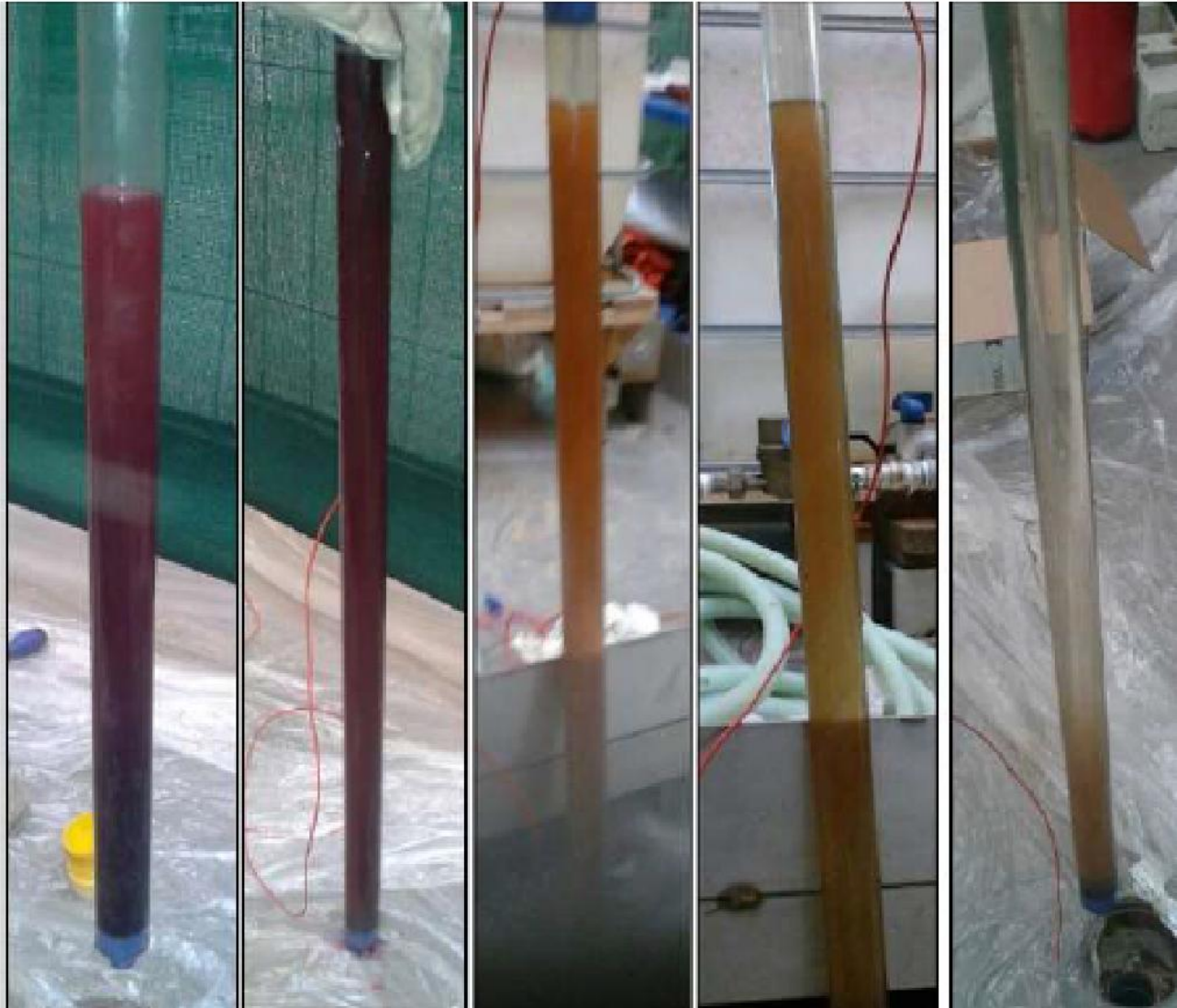



5.5 Process and performance monitoring

In addition to the 5 monitoring points of the pilot project phase, further 4 control points were installed.

- Before injections, in all the existing piezometers, the following parameters were measured at different depth using a multiparametric probe: temperature, dissolved oxygen, pH, conductivity, redox potential and salinity;
- During the injection phase all the piezometers were monitored in order to assess the propagation of the oxidation conditions;
- After the injections, all piezometers were monitored on a daily basis for the first 3 days in order to assess the propagation of the oxidation conditions following the injections.

6. Post treatment and/or Long Term Monitoring

6.1 Post treatment and/or Long Term Monitoring

After ISCO application all piezometers were monitored on a daily basis for the first 5 days, verifying oxidant traces and pollutants concentrations.

Then sampling surveys were carried out once a week for 1 month to check the content of: manganese, chlorinated solvents and polycyclic aromatic hydrocarbons

A long term monitoring was carried out to verify the fulfilment of remediation goals: Bi-annual monitoring of piezometers at quarterly frequency for the first year and then every six months.

The parameters analyzed during the biannual monitoring are: PAH, chlorinated solvents, BTEX, total hydrocarbons, Metals (Mn, Cr (VI), Cr (total)).

7. Additional information

7.1 Lesson learnt

Presence of buildings or underground services was a limiting factor for the application of this remediation technique.



7.3 Training need

Training course on transport models in groundwater.

Glossary of Terms

Term (alphabetical order)	Definition
PRB	Permeable Reactive Barrier
SOD	Soil Oxidant Demand
SIN	Sito di Interesse Nazionale (National Interest Megasite)

1. Contact details - CASE STUDY: ISCO n.13

1.1 Name and Surname	Puricelli Sara, Marin Rosa Angela, Ricci Diego, Confalonieri Massimiliano
1.2 Country/Jurisdiction	Italia
1.3 Organisation	ARPA Lombardia
1.4 Position	
1.5 Duties	
1.6 Email address	s.puricelli@arpalombardia.it ; m.confalonieri@arpalombardia.it
1.7 Phone number	+39 031 2743913

2. Site background

2.1 History of the site: Challenges and Solution

The industrial site in question is located in Northern Italy within an area subject to archaeological and hydrogeological constraints, in the vicinity of an important surface water body (which passes 250 m downstream of the site). The site occupies an area of approximately 63,000 m², of which approximately 50% is occupied by buildings (currently for non-productive use, but intended for the provision of services) and the remaining part used for parking and green areas.

The characterization highlighted a significant contamination by organohalogen solvents for the groundwater in the southern area of the site. This site corresponds to the area used for the storage of waste containing chlorinated solvents - used in degreasing and painting laboratories - on which degraded barrels are also located.



There are no specific protocols for the management of this site, but the control and technical evaluation activities in support of the Municipality (proceeding administration appointed by the Region for the management of contaminated sites) are carried out by ARPA. ARPA is the Environmental Protection Agency established in 1999 that deals with the prevention and protection of the environment, supporting regional and local institutions in multiple activities including:

- atmospheric pollution;
- noise pollution;
- water protection for surface water and ground water
- monitoring electromagnetic fields
- investigations on soil contamination and remediation processes.

The remediation activities through injection were carried out in the period between the 4th till 21st September 2012.

2.2 Geological and hydrogeological setting

The investigations carried out at the site revealed the presence of a semi-confined aquifer with a silty clay substrate (with low permeability at about 30-32 m from ground level and groundwater level at -6m. In the source of contamination area, which was subjected to ISCO, the saturated matrix had a thickness from -12m to -37m.

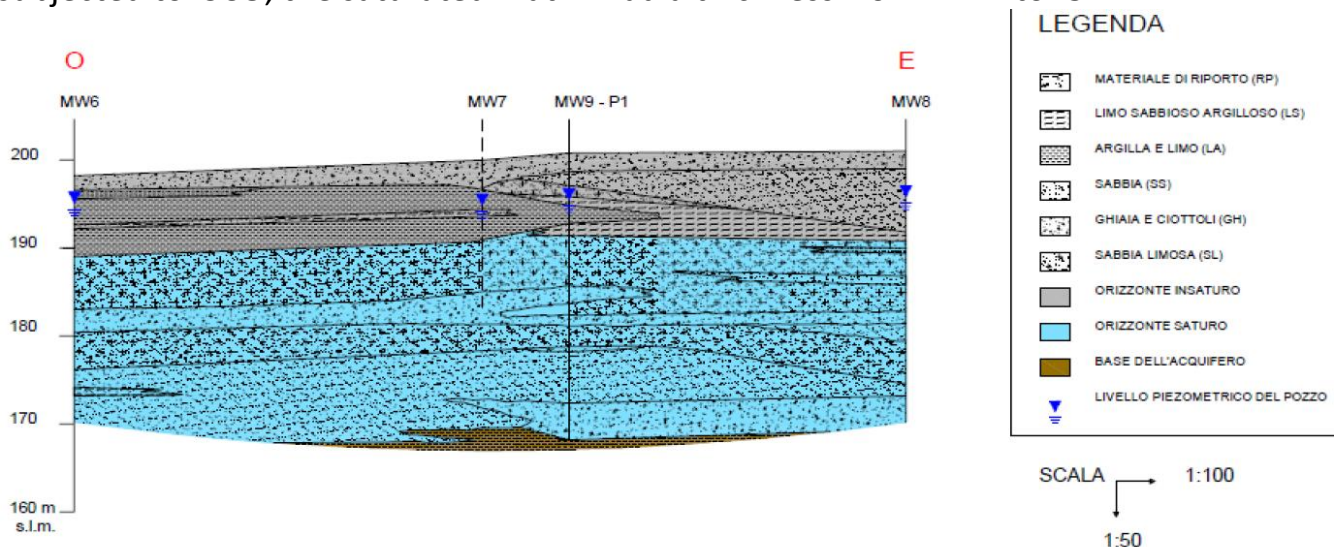

The local outflow of the aquifer is E-W in the portion of the site involved in the intervention. The average hydraulic gradient is equal to 0.5% and the permeability varies from 4.4×10^{-5} m/sec to 5.5×10^{-5} m/sec, the flow rate of the groundwater has been calculated equal to about 40 m/year.



In order to acquire more detailed information for the preparation of the remediation project, regarding the extent of contamination, an investigation was carried out using MIP (Membrane Interface Probe) consisting of 10 drilling points pushed to a depth of 35 m below ground surface thus being able to evaluate an area of about 175 m² around the MW8 piezometer.

2.3 Contaminants of concern

The environmental characterisation study was performed in 2001, from which, chlorinated solvents with concentrations in groundwater equal to approximately 3,000 µg/L were identified. The main contaminants detected were, in the order of concentrations found, PCE and, alternatively, TCE, 1,1 dichloroethylene. There was no evidence of the presence of the free product (DNAPL for chlorinated products) which is denser than the water to be sought at the base of monitoring piezometers.

Unsaturated soils in the same area did not show contaminant values higher than the CMA (Maximum Permissible Concentrations) established by the then current Ministerial Decree 471/99, also because it had been the subject of an EVS intervention.



2.4 Regulatory framework

The proceeding was conducted according to Ministerial Decree 471/99 as the proceeding was initiated in 2001, before the entry into force of Legislative Decree 152/2006.

Following the finding of values higher than the CMA, the preliminary remediation Project was presented to define all the suitable and economic sustainable remediation methodologies useful for the site. The EVS intervention was selected for the unsaturated and a direct oxidation technology in situ (ISCO) with KMnO_4 for the saturated. This also involved the execution of appropriate laboratory tests and a pilot test in situ.

An emergency safety intervention was also carried out on the aquifer, through the construction of a hydraulic barrier to avoid the migration of contaminants downstream.

The ISCO treatment was performed in accordance with the technical indications provided in Protocol No. 28220 of 20/07/2005 prepared by APAT (now ISPRA) for the application of chemical oxidation in situ.



3. Laboratory-scale application in field

3.1 Laboratory scale application

The purpose of the tests was to evaluate the PNOD (Permanganate Natural Oxygen Demand) parameter which represents the natural oxidant requirement for permanganate; i.e. the amount of permanganate necessary for the oxidation of organic and inorganic compounds naturally present in the soil.

Four soil samples and two groundwater samples were taken from the source area, for the batch tests carried out independently by the operator. PNOD was found to vary between 1 and 7 kg KMnO_4/m^3 soil as a function of the depth of the soil.

For the design, an average concentration of organohalogen compounds equal to 2 mg/l was considered; the stoichiometric KMnO_4 /contaminated ratio of 3.



4. Pilot-scale application in field

4.1 Main treatment strategy

In choosing the remediation technology, due consideration was placed for the presence of low permeability horizons that made more traditional techniques, such as Air Sparging, unfeasible.

Pharmaceutical grade Potassium permanganate (KMnO_4) was used in a 3% solution, with a maximum content of impurities such as to allow the injection of a solution that complies with the quality requirements of the Ministerial Decree 471/99 with the obvious exception of the manganese parameter.

For permanganate (sodium or potassium), the half-reaction of reduction in the typical conditions of the subsoil with pH between 3.5 and 12 is as follows:

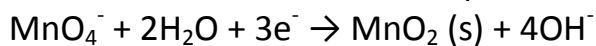

The manganese dioxide MnO_2 that is formed is an insoluble solid that is even used as a filter medium for the reduction of manganese concentrations from groundwater, therefore non-toxic and already known in remediation procedures. Manganese dioxide precipitates as a particle or as a colloid. As a result, the application of permanganate, at the end of the oxidation reactions, does not result in an increase in the concentrations of dissolved manganese.

Below are the oxidation reactions of the two main contaminants found in the groundwater:

Perchloroethylene (PCE):



Trichloroethylene (TCE):



Before the injection, a zero-time monitoring campaign was carried out, at T0, to be considered as a reference before carrying out the ISCO injections.

4.3 Injection type

The 2004 field pilot test was conducted with injection wells to allow greater flexibility during injections and sampling.

Three PVC injection wells with a diameter of 3" (IW1-A, IW1-B and IW1-C) made *ad hoc*, located at the vertices of a triangle, slotted respectively (slot 1 mm) in the following intervals: 25 -30m, 18-25m, 12-18m. In addition, three monitoring wells (MP2-A, MP2-B and MP2-C) were made with slits in the same intervals as those of injection. A plan of the pilot plant is shown in the figure below.

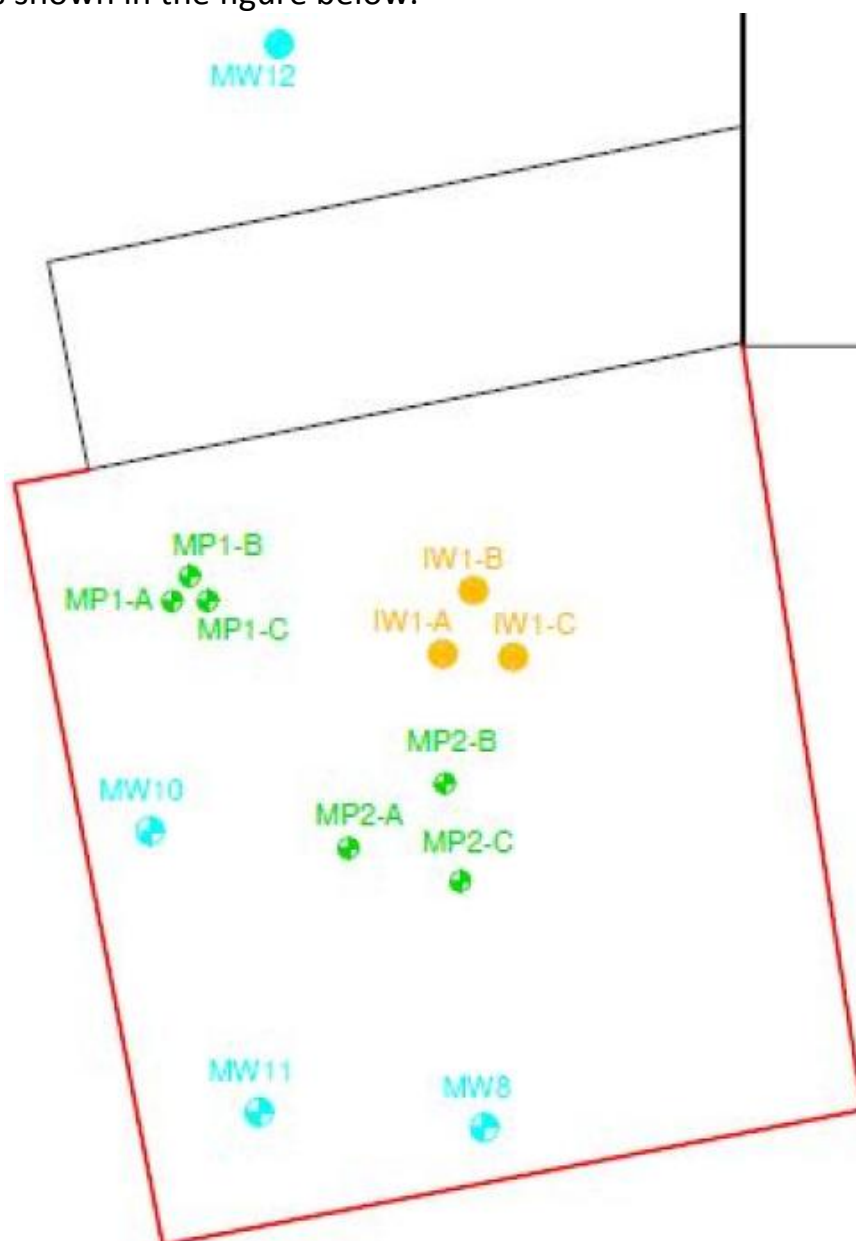

350 kg of permanganate were injected on the deep and intermediate intervals and 375 kg on the surface, in a single campaign, using the structures outlined below.

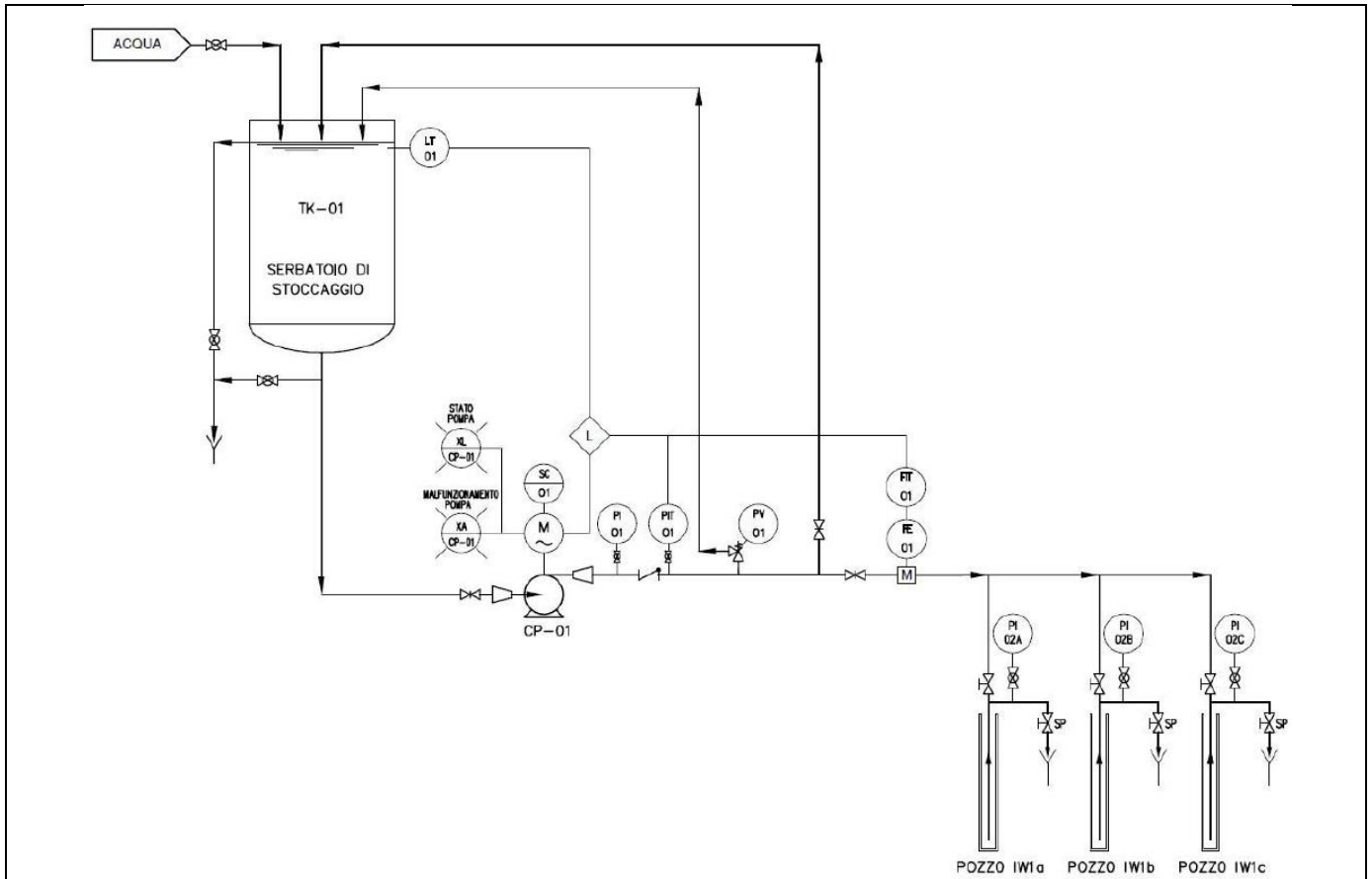

Finally, a photograph of the pilot plant is shown in order to demonstrate the scarcity of impact, compatible with an activity in operation.





4.5 Control parameters

The control parameters concerned the monitoring of the compounds of interest of any oxidation by-products and the recording of physical parameters with a multiparametric probe, with particular attention to the redox potential and conductivity.

In general, the concentrations of organohalogen compounds rapidly decreased, even below the detection limit, and then sometimes increased again, usually to much lower values than the initial starting concentration, in the latest monitoring campaigns. This phenomenon can be explained by the spatial and temporal limitation of the intervention which had evidently not completely eliminated the secondary source of contamination in the soil (as confirmed by the preliminary MIP investigations). The most relevant PCE concentrations remained confined to downstream-flow control piezometers.

Concentrations of TCE generally decreased, albeit to a lesser extent than PCE.

In the triplet of injection piezometers, the redox potential remained stabilized around 500 mV. The conductivity values initially increased at all points, with values of the order of $10^3 \mu\text{S}/\text{cm}$ at the injection points.

During the pilot test, no accumulations of organohalogen compounds with a low number of chlorine atoms (dichlorethylene and vinyl chloride monomer) or of other secondary organohalogen compounds were observed. This indicated that the oxidation of the organohalogen compounds was complete and that there was no risk of accumulation of compounds with a lower number of chlorine atoms.

5. Full-scale application

5.1 Main Reagent

NaMnO_4 was used as an alternative to the KMnO_4 used during the pilot scale test for operational needs, as it is more cost-effective, more soluble and with the advantage of using smaller injection volumes.

The reactivity of the two species is identical as the active ion is always the permanganate ion, with the only change being the dosage for the different molar weights.

The criteria for selection between the two salts was based on the greater ease of using a liquid instead of a solid and on the difference in cost. It should also be noted that the use of a solution presents fewer health and safety problems as the handling takes place entirely in the liquid phase without the emission of dust.

Below is a diagram of the injection systems of the oxidizing reagents which highlights the greater simplicity of management of sodium permanganate.

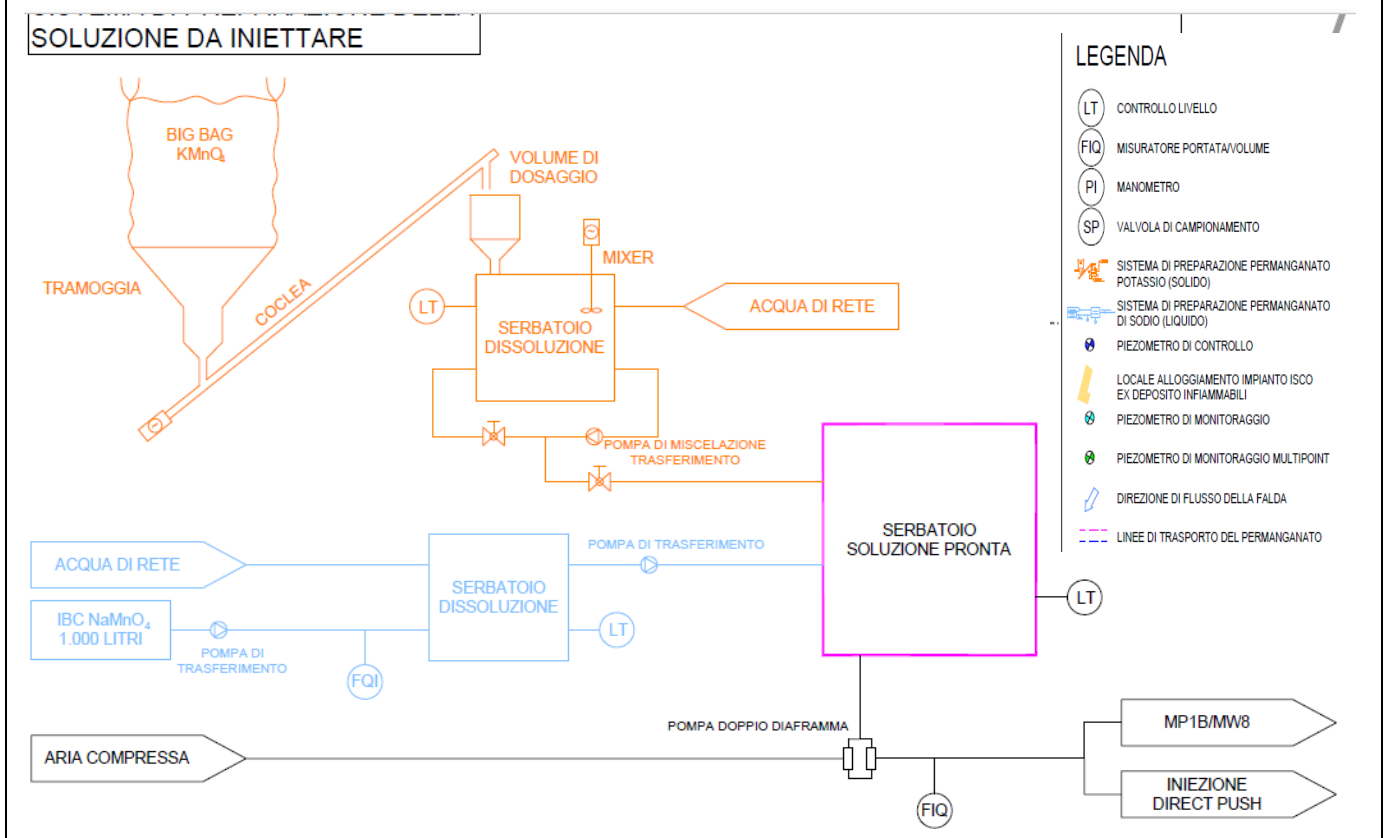

5.3 Injection type

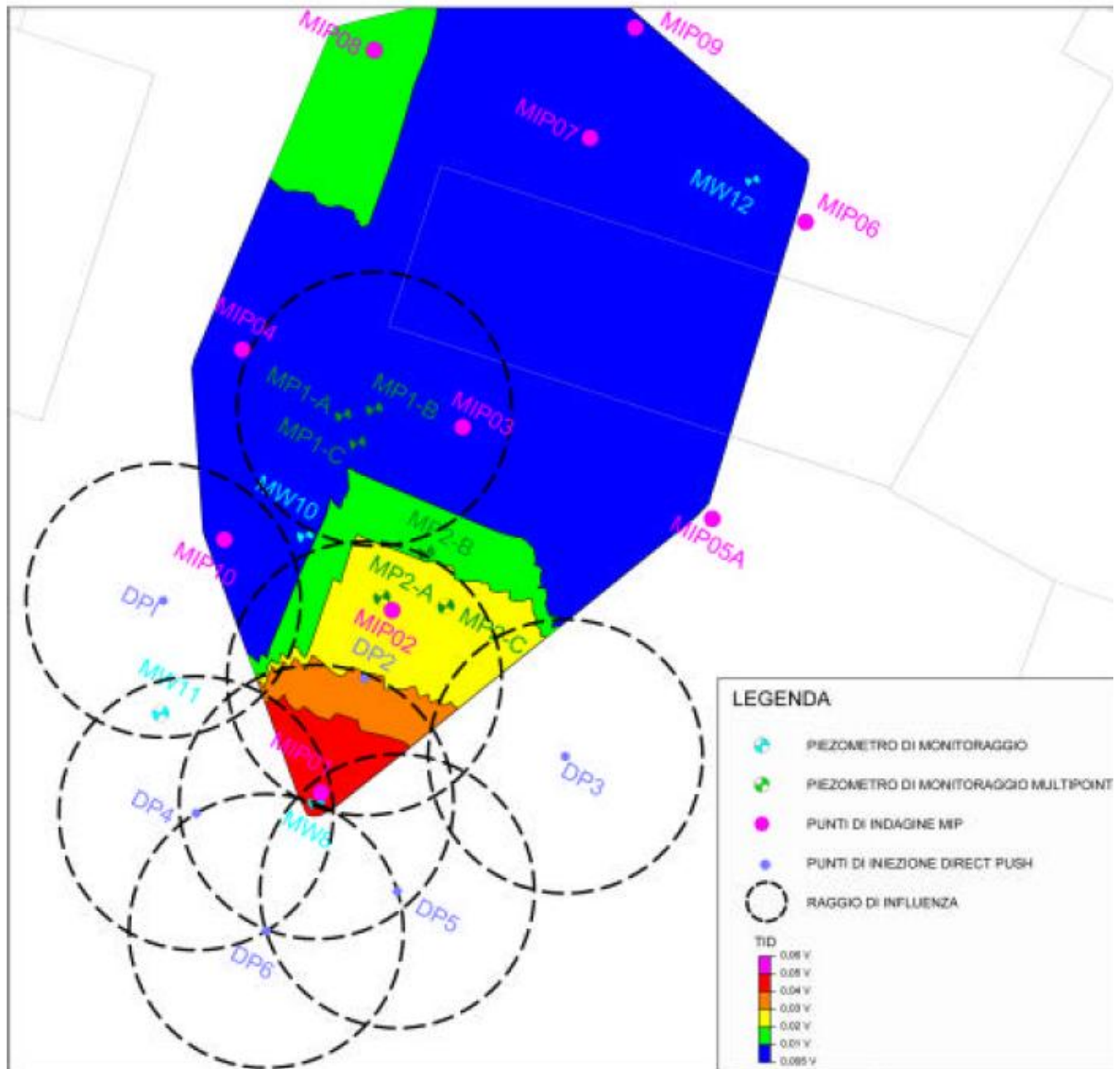

Injection points

The treatment, from the Reclamation Plan (PdB) included:

- The construction of 6 injection points in the area with the greatest contamination (around MW8), identified by the initials DP1 ÷ DP6, with permanganate injection with direct-push technology, at depths between 12 m and 37 m below ground surface;



- direct injection of permanganate into existing MW8 and MP1b piezometers;
- construction of an ad hoc monitoring piezometer (MW13) located downstream of the area subjected to reclamation, equipped with a barrier well, in compliance with the indications of the APAT 2005 Protocol, to be activated in the event of the presence of unreacted permanganate, with re-entry of the same in the MW12 piezometer located upstream of the treated area, creating a closed circuit that also acted as a barrier.

A continuous monitoring system was installed on this piezometer, consisting of a parametric probe aimed at determining the redox potential, associated with an alarm system that would allow, in the event of an anomaly or a potential leakage of the oxidizing agent, the immediate activation of the pumping activity.

Considering the need to inject at different depths, on considerable thicknesses with volumes of complex geometry, the "direct push" methodology was used, which allowed better dosing of the reagents using closer injection points with lower costs than those of injection wells.

A Geoprobe type probe was used, through injections in the 3 intervals -12-16 m; -16-25 m; -25-37m from p.c., also monitoring of the volumes injected was carried out.

The volume of land to be treated, at the design level, was estimated to be 4,648 m³, equivalent to approximately 7900 t, for which a quantity of KMnO₄ equal to 17973 kg was used, considering all the organic substances present in the soil on the basis of laboratory tests.

In addition to the piezometers from the PdB, an additional injection point (DP7) was also created for the injection of permanganate and the MW10 piezometer was also used, due to the poor filtering capacity of the piezometers which tended to disperse the reagent very slowly, slowing down injection operations.

We proceeded with a first dose of 20207 kg of NaMnO₄ equal to 9000 kg of permanganate (50% of the requirement), reserving the right to integrate this requirement later; being in solution at 40% by weight, this mass corresponded to an overall volume to be injected equal to 128 m³ of solution.

Compared to the design data, the volumes of injected permanganate have been modified, mainly due to the lithological nature, represented by very compact silt in the deeper horizons.

The injection pressure was always lower than 6 bar, thus avoiding macro-fracturing of the aquifer.







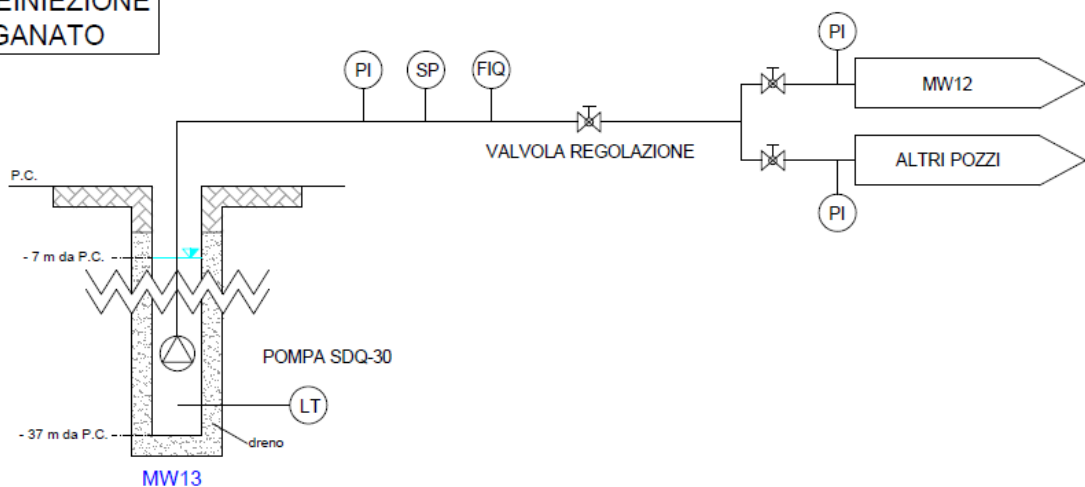





In order to control the possible migration of groundwater containing unreacted permanganate downstream from the hydrogeological area of the intervention area, a

control piezometer (MW13) was created which was pumped when the water present in the piezometer itself showed a violet colour (index of the presence of unreacted permanganate); the extraction was interrupted when the presence of permanganate was no longer visually detected and in any case before the test was carried out. The water extracted from MW13 was re-injected into the monitoring wells present inside the intervention area (in MW12 upstream of MW13) in order to fully exploit the extracted reagent and to create a dynamic treatment cell improving the distribution of oxidant, according to the system specified below.

SISTEMA DI REINIEZIONE DEL PERMANGANATO



LEGENDA

-  CONTROLLO LIVELLO
-  MISURATORE PORTATA/VOLUME
-  MANOMETRO
-  VALVOLA DI CAMPIONAMENTO
-  SISTEMA DI PREPARAZIONE PERMANGANATO POTASSIO (SOLIDO)
-  SISTEMA DI PREPARAZIONE PERMANGANATO DI SODIO (LIQUIDO)
-  PIEZOMETRO DI CONTROLLO
-  LOCALE ALLOGGIAMENTO IMPIANTO ISCO EX DEPOSITO INFIAMMABILI
-  PIEZOMETRO DI MONITORAGGIO
-  PIEZOMETRO DI MONITORAGGIO MULTIPOINT
-  DIREZIONE DI FLUSSO DELLA FALDA
-  LINEE DI TRASPORTO DEL PERMANGANATO



5.4 Radius of influence

A range of influence of 3.5 m was defined on the basis of the pilot test.

5.5 Process and performance monitoring

The monitoring consisted during the ISCO injection in the measurement of physical parameters with a multiparametric probe, namely: redox potential, dissolved oxygen, conductivity, pH and temperature twice a day. In particular, in the MW13 control piezometer, the continuous measurement of conductivity was provided to evaluate any permanganate leakage.

The first check in terms of chemical analysis of the compounds of interest was performed one week after the end of the injections.

Below is a summary of the monitoring carried out:

Deadline	MW13 (colour and redox)	pH, redox, conductivity, DO, T°, colour	Chemical analyses
Before the injection	NO	YES (a)	YES (a)
End of injection T0	YES	YES (b)	NO
1 week from T0	YES + analysis	YES (b)	NO
2 weeks from T0	YES	YES (b)	NO
3 weeks from T0	YES	YES (b)	NO
1 month from T0	YES + analysis	YES (b)	YES (b) + MW1
6 weeks from T0	YES	YES (b)	NO
2 months from T0	YES + analysis	YES (b)	YES (b) + MW1
3 months from T0	YES + analysis	YES (b)	YES (b) + MW1
4 months from T0- TESTING	YES	YES (a)	YES (a)

(a) Complete piezometric network: MW1, MW2, MW3, MW4, MW5, MW6, MW7, MW8, MW9, MW10, MW11, MP1-B, MP1-C, P1, EW1

(b) Reduced piezometric network: MW7, MW8, MW10, MW11, MW12, MP1-B, MP1-C and P1

The groundwater samples taken during the monitoring were subjected to the determination of organochlorine solvents, manganese and the following metals: Cd, Cr



VI, Fe, Cu, Pb, Zn. For the MW13 piezometer alone, the permanganate ion concentration was also determined.

The monitoring plan provided that, if the project objectives were achieved four months after the remediation intervention, post-operam monitoring would be activated; alternatively a second injection session would have been performed maintaining the same monitoring protocol as above, which was not necessary.

Due to an "anomalous" PCE value found on the expected date of testing on the MW4 piezometer upstream of the intervention area as well as the persistence of the purple colour inside the source area, testing was postponed to the next sampling, but also in this circumstance it was ascertained the persistence of the violet colour on the MW8 and MW11 piezometers inside the source area.

In the subsequent monitoring campaigns this criticality no longer emerged and the achievement of the remediation objectives for the organohalogen solvents for all the monitored points was verified.



6. Post treatment and/or Long Term Monitoring

6.1 Post treatment and/or Long Term Monitoring

From the end of the testing, post-construction monitoring was carried out for six years, starting from May 2013, according to the specifications shown in the table.

	Sampling	Frequency	Follow up actions
1st year	Complete piezometric network	quarterly	If compliant with the Italian threshold limits (CSC-CSR): shutdown of P1 (barrier well)
2nd year	Complete piezometric network	quarterly	
3rd year	Complete piezometric network	half-yearly	
4th year	Complete piezometric network	half-yearly	
5th year	Complete piezometric network	half-yearly	
6th year	Complete piezometric network	half-yearly	

The groundwater samples taken during post-construction monitoring involved the determination of organochlorine solvents and metals (Mg, Cd, Cr VI, Fe, Cu, Pb and Zn) only.

The last campaign carried out showed significant reductions in Mn, indicating that the permanganate had completely reacted in all the monitoring piezometers.

Barrier well P1 was shut down in July 2016.



7. Additional information

7.1 Lesson learnt

In general, ISCO offers the following advantages:

- ability to quickly treat a wide range of organic contaminants;
- allows you to set up temporary construction sites of limited size;
- It is particularly suitable for aliphatic compounds that chlorinate in not excessively fine horizons, to avoid the risk of rebound.

As a case-specific criticality, the presence of unreacted permanganate in the injection area was highlighted and therefore the barrier well was kept in operation until the injected permanganate was used up, as well as the maintenance of CSCs at the point of compliance. On the basis of the pilot test performed on site, however, the consumption of the injected product had occurred completely.

The lithological nature of the area subjected to injection, represented by very compact silt in the deeper horizons, has presumably influenced the distribution of permanganate, greatly slowing down its degradation. On the other hand, the failure to detect permanganate in the MW13 spy piezometer, located immediately downstream of the injection area, confirmed the poor mobility of the product due to the low permeability of the soil.

It is also noted that, from the analysis of the results of the post-operam monitoring, it is observed that with the exception of the MW8 piezometer, in which it is possible to appreciate the effectiveness of the intervention with total abatement of organohalogen solvents, for the other monitored points located in the area source (MW10, MP1B, MP1C) the concentrations of some halogenated solvents after total abatement in the first 4 months from injection gradually increased, settling on values around 15-20 ppm. This result is difficult to explain, especially if associated with the presence of unreacted product in the same points.

In relation to the monitoring of metals, the analysis of the analytical data showed a significant increase in the concentrations of Mn and lower increase of Fe in the piezometers located in the source area. No significant variations in the concentrations of metals before and after the intervention (therefore correlable to ISCO) for the other monitored piezometers were noted.

7.2 Additional information

The remediation objectives consisted of achieving concentration values below the Italian risk threshold (CSRs) for all the piezometers inside the site, defined by applying the site-specific risk analysis and coinciding with the contamination threshold concentrations (CSCs), i.e. the table limits conformity verification) for the MW7 piezometer placed at the site boundary, in the hydrogeological valley position, as specified in the table:

Parameter	CSR ($\mu\text{g/L}$) for all piezometers inside the site, from Risk Assessment evaluation with reference to the "inhalation" path	CSR = CSC ($\mu\text{g/L}$) For MW7 or site compliance point
PCE tetrachlorethylene	97	1.1
Trichloroethylene TCE	440	1.5
1,1 dichlorethylene	6.8	0.05
Cis-1,2 dichlorethylene	16000	60
1,2 dichloropropane	87	0.15
1,1,2 trichloroethane	220	0.2
Vinyl chloride	38	0.5

7.4 Additional remarks

With regard to the main limitations of this technology, it should be noted that:

- There is a need to ensure a physical or hydraulic barrier / margin protection system downstream of the treatment, in order to evaluate any leakage of the oxidizing agent outside the site or to avoid any migration phenomena of the reaction by-products towards sensitive targets (also in compliance with the 2005 APAT protocol mentioned above);
- Very strong oxidants can be corrosive and potentially explosive therefore particular attention must be paid to health & safety consideration ;
- The effectiveness of the process is influenced by the presence of heterogeneity of



the subsoil or by the poor mixing of the reagent in the groundwater;

- In certain cases, in areas difficult to access to the reagent, such as fine materials, the occurrence of rebound phenomena is noted. Consequently it is necessary to proceed with further injection cycles;
- Some reactants can be consumed by other oxidizable substrates present in the subsoil, thus limiting the effectiveness of the treatment;
- The use of permanganate could cause temporary increases in manganese concentrations and the precipitation of manganese oxides.

Glossary of Terms

Term (alphabetical order)	Definition
CMA	Maximum Permissible Concentrations
CSC	contamination threshold concentrations
CSR	Risk Threshold Concentrations
D.Lgs.	Legislative decree
D.M.	Ministerial decree
MIP	Membrane Interface Probe
PdB	Remediation Plan
PNOD	Permanganate Natural Oxygen Demand
SVE	Soil vapour extraction

1. Contact details - CASE STUDY: ISCO n.14

1.1 Name and Surname	Uwe Dannwolf
1.2 Country/Jurisdiction	Germany
1.3 Organisation	RiskCom GmbH
1.4 Position	Managing Director
1.5 Duties	Project Manager
1.6 Email address	uwe.dannwolf@riskcom.de
1.7 Phone number	+49 8851 8969 480

2. Site background

2.1 History of the site: Challenges and Solution

From 1945 through 1983 “processing” of used chlorinated hydrocarbons took place on the subject area (former garage shop). Initial site investigations started in 1984. A six-year-long pump & treat remediation ceased in 2006.

Due to continuously high groundwater concentrations of PCE/TCE of up to 200,000 µg/L remediation was necessary.



Because parts of the subsurface contamination are located below a main road (see picture below) with services including a sewer, gas pipeline, telecommunications only in-situ remediation technologies were deemed feasible for remediation of this specific sub area. A variety of methods were evaluated including thermal but from a cost-benefit viewpoint was ISCO using hydraulic fracturing as the preferred method.

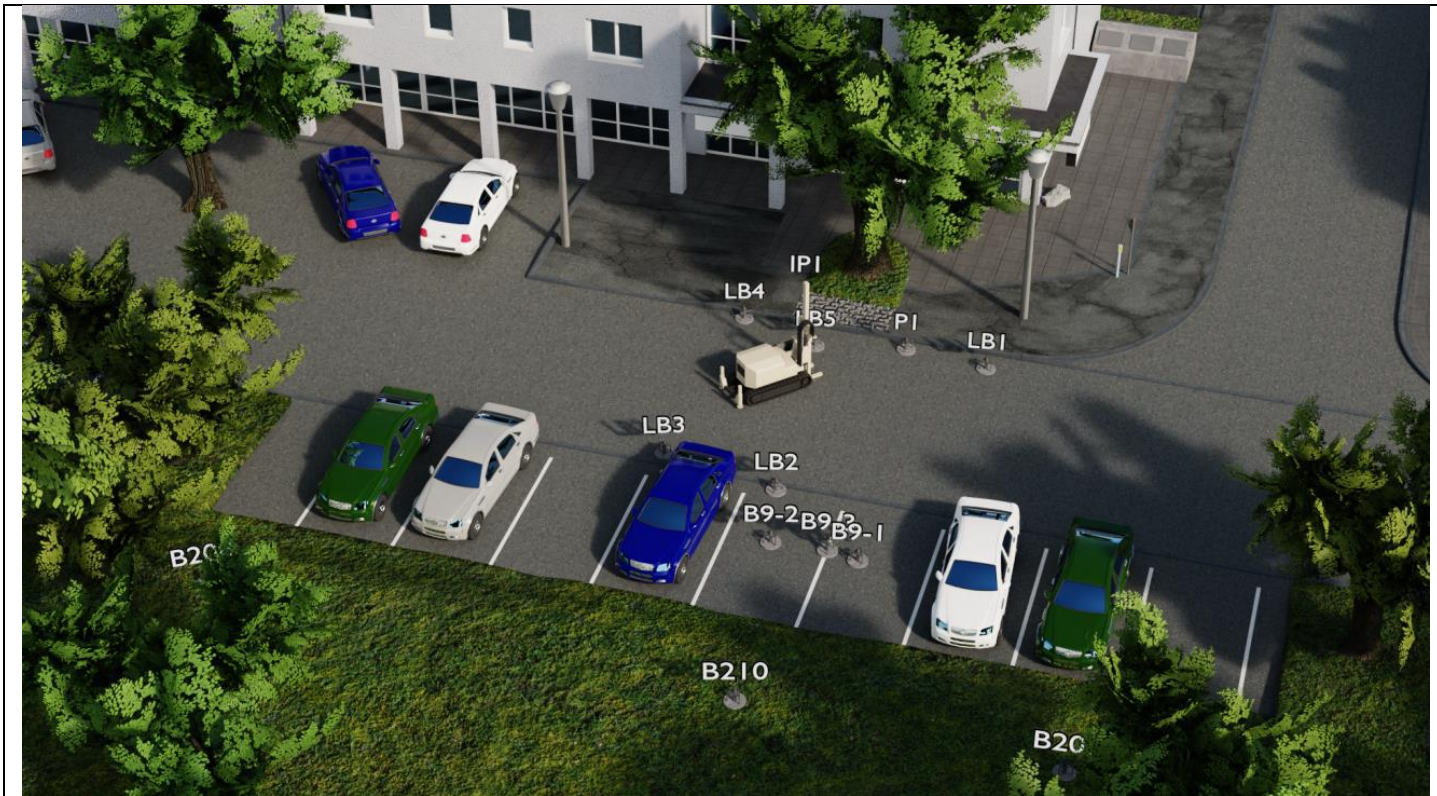

2.2 Geological and hydrogeological setting

The site is underlain by fill and Quaternary loess to a depth of 4 m below ground surface (bgs), which is overlaying a clayey silt layer followed by some silty clay layer of weathered marlstone to a depth of 7.5 m containing some perched water which is followed by the more competent, naturally fissured marlstone (Lias β). The marlstone reaches down to at least 12 m bgs and serves as a confined low permeability dual porosity „aquifer“ with a groundwater flow of only 5 m / month mainly occurring in the fissures. The permeability of the weathered marlstone clay is 7×10^{-9} m/sec and marlstone exhibits a permeability of about 5×10^{-7} m/sec.

A redox boundary formed at a depth of around 6 m bgs (see picture below).

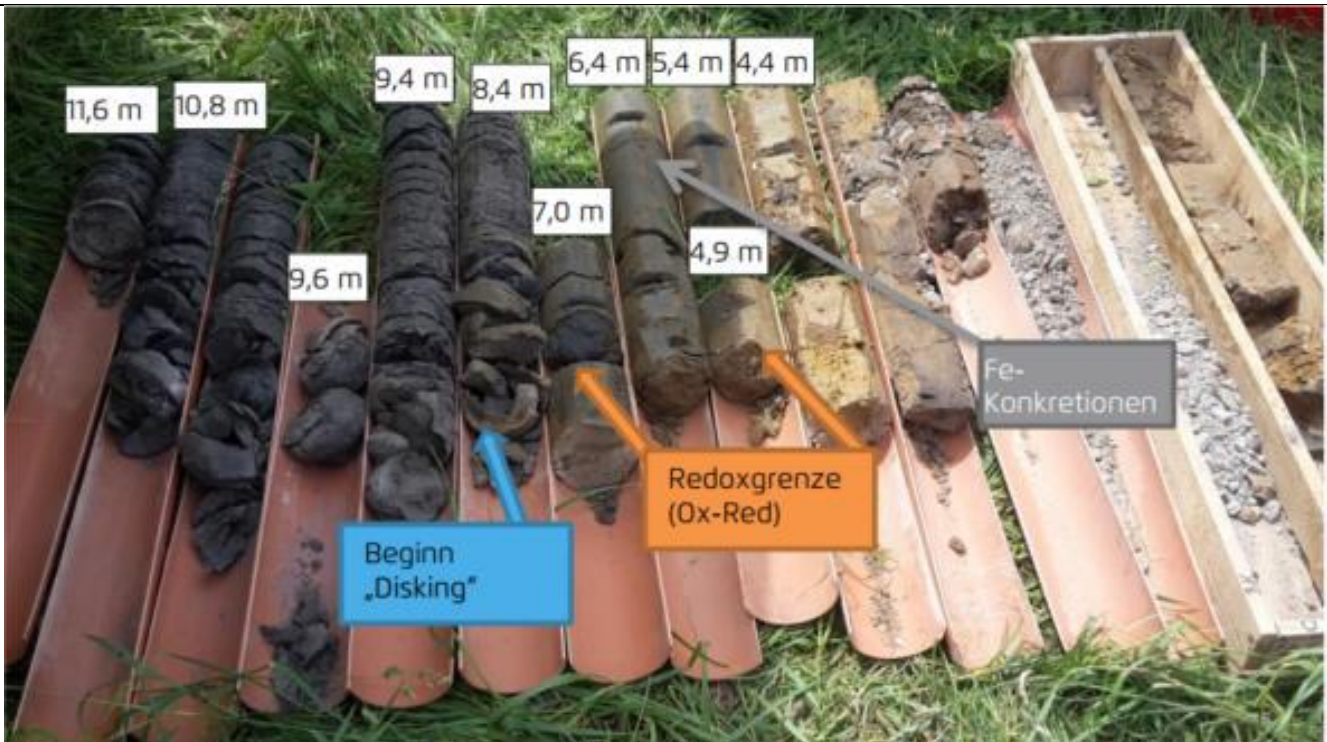

During the investigation phase, it was noted that the soil exhibited spots of high concentrations with neighbouring spots of low concentrations. The only interpretation at the time concluded that the subsurface is heterogeneous.

As a consequence, it was conducted research into the depositional environment followed by statistical analysis of the soil data including the type of clays. It could be shown that the natural heterogeneity based on TOC; Fe, Mn, Al, and NOD analyses had only a variation of $\pm 20\%$. This was much lower than the contaminant data variation which exceeded $\pm 140\%$. It was found that secondary diking structures were formed post-depositional and as a result of Tertiary and Quaternary overburden weathering. Post deposition and thereafter a vertical fracture network developed (as shown today in the marlstone) which subsequently partially healed as shown in the overlying tight weathered silty clays. This narrow spaced natural fracture network (fracture distance 0.2 m to about 1 m) was the pathway for contaminants to enter the subsurface to a depth of at least 10 m bgs. Vertical analytical transport modelling using a spreadsheet software proved this hypothesis.

From the CPTU data it was concluded that the soil contained some perched water to a depth of 4 m bgs. Below that depth the soil exhibited a pore water suction potential between -0.04 to -0.09 MPa to a depth of 12 m bgs. This fact had the potential of limiting the ISCO application significantly. Further research showed that for the reported suction potential enough water is present for sufficient diffusion of the oxidative front emanating from the permanganate and persulfate agents.



2.3 Contaminants of concern

Results of investigations in 2006 identified CVOC soil concentrations of the weathered clay of up to 75 mg/kg. Subsequent MIP-and CPTU investigations (pre RiskCom's involvement) including liner sampling provided a more detailed picture of the contamination and provided relevant geotechnical data in order to reliably plan the injection using hydraulic fracturing. Significantly higher CVOC soil concentrations of > 6,000 mg/kg were analysed during this campaign.

Groundwater samples indicated extreme concentrations of up to 447,000 µg/L total CVOC (on average about 150,000 µg/L) and up to 6,200 µg/L BTEX.

2.4 Regulatory framework

Due to continuously high groundwater concentrations of PCE/TCE of up to 200,000 µg/L, a remedial order was instigated.

The remediation plan focused on achieving a reasonable groundwater quality. Hence, a maximum CVOC discharge rate (i.e. mass flux) was prescribed. The prescribed goal is to reduce the contaminant mass with proportional means to such an extent that the long term total CVOC emission via the groundwater path is below 1 kg/a. An initial remediation target value for soil was 100 mg/kg total CVOC.

The competent Authorities were well satisfied with the method of hydraulic stimulation and the injection of 6 tons of permanganate and persulfate as solids was approved for the pilot test.



3. Laboratory-scale application in field

3.1 Laboratory scale application

Several lab tests for determination of a stoichiometric oxidant demand were conducted.

- SOD1 test on four samples with permanganate, and persulfate
- SOD2 batch tests on four soil samples before the injection with ground and intact soil samples from the clayey silt layer and the weathered marlstone for a period of 28 days
- SOD2 batch tests on ten soil samples from liner bores of the clayey silt layer and the weathered marlstone after the injection.

TIC and TOC as well as Fe and Mn were determined. With that data we were able to determine the oxidation state of the organic matter (OC) to +2.1 on average. With this evaluation the stoichiometric demand could be determined much better than using the standard methodology.

From the test results before the injection and after the injection the effectiveness of the oxidation was determined for the fraction of organic carbon and the CVOCs. It was determined that the clayey silt layer had a permanganate oxidant demand of 59 g/kg and the weathered marlstone had a permanganate oxidant demand of 78 g/kg. The SOD fast portion consisting of mainly Fe and OC required about 54% of the total SOD.

It could be shown from a detailed evaluation of the CPTU data that the suction potential is still in a range where saturated diffusion occurs. Henceforth, further kinetic parameters from the SOD2 tests were derived and initially an analytical kinetic diffusion model was developed and run. Later a numerical diffusion model ("quasi 2D") was run using CVOC input concentrations between 100 mg/kg to 2,000 mg/kg. It could be shown that PCE and TCE are faster oxidised than the SOD fast. SOD slow was much slower than the SOD fast which resulted in a 5 cm diffusion front for permanganate even for the 2,000 mg/kg CVOC concentration.

Consequently, the vertical distance between the hydraulically emplaced and permanganate laden fractures had to be in a 10 cm distance for a complete oxidation of the soil profile.

This distance of 10 cm was smaller than the distance originally chosen in the pilot test. Nevertheless, the result indicated that a complete remediation can be achieved if the full-scale application is conducted.

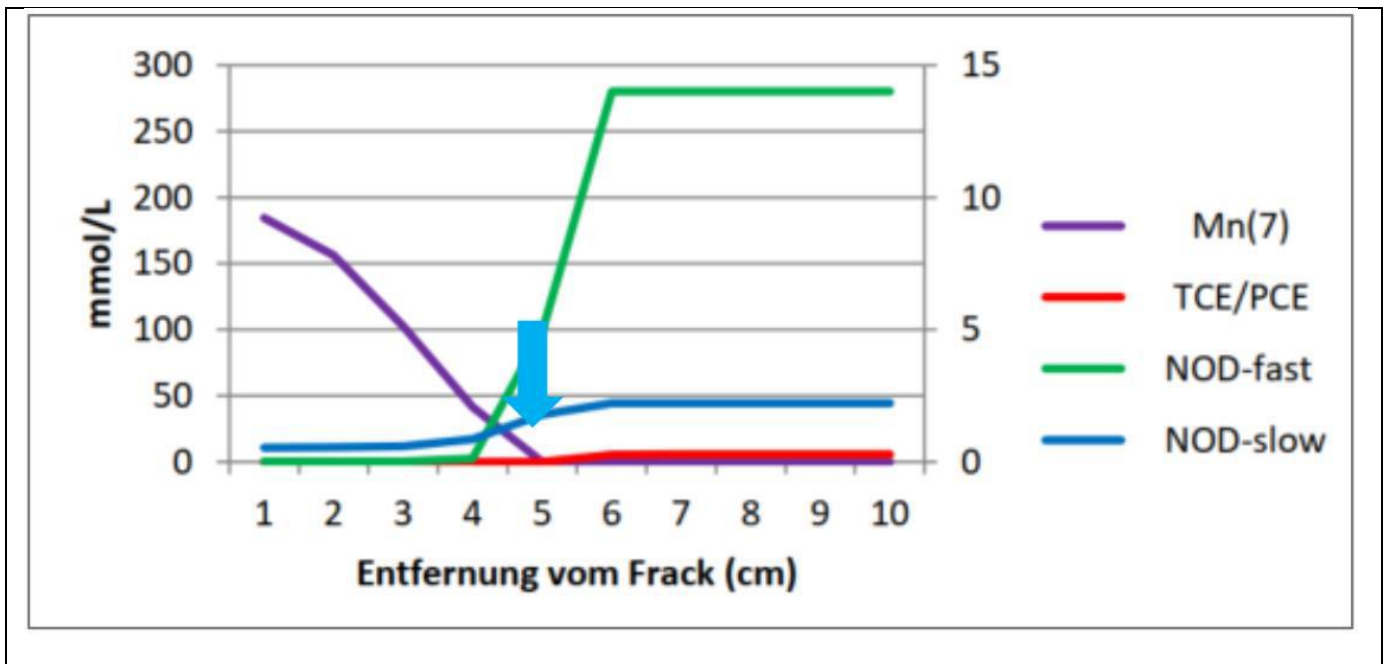

4. Pilot-scale application in field

4.1 Main treatment strategy

Due to the low permeability soil at the site hydraulic fracturing as injection technique was selected for the subsurface contamination below the main road, which was the pre-selected location for the pilot test. For the pilot test only one injection borehole was drilled. Remediation reagents were injected in the main contaminated area between 6.2 m and 10.5 m depth in a vertical distance of mainly 0.15 m.

Due to the low permeability clay and marlstone and the limited advective groundwater flow in the saturated zone as well as the dry conditions in the unsaturated zone, the injection of a combination of potassium permanganate (KMnO_4) and sodium persulfate ($\text{Na}_2\text{S}_2\text{O}_8$) was planned for the pilot test.

KMnO_4 was selected due to its fast reaction kinetics for the CHCs, its high diffusion coefficient, and its lack of interference with hydrogen carbonate ions. $\text{Na}_2\text{S}_2\text{O}_8$ was selected due to its low solubility and the long persistence as well as its reported (e.g. Siegrist et al., 2011) lower tendency to oxidize the NOM (natural organic matter). It was intended to inject a 50%-mix of the reagents.

After the injection of each 1.6 t KMnO_4 and $\text{Na}_2\text{S}_2\text{O}_8$ between 6.2 m and 7.55 m a slight uplift of the road and a slight widening of an existing crack in the road were observed. It was concluded that the heave was attributable to a spontaneous gas formation. The gas



formation was generated through the addition of $\text{Na}_2\text{S}_2\text{O}_8$ and the addition of 10% NaOH as activator. A post evaluation of the reaction kinetics showed that the amount of bivalent iron available in the soil would have been sufficient for the activation of $\text{Na}_2\text{S}_2\text{O}_8$. In this case the alkaline activation was excessive and unnecessary. As a consequence of the crack widening, the injection of $\text{Na}_2\text{S}_2\text{O}_8$ was immediately ceased. The subsequent injection was carried out with KMnO_4 only. At a depth of 8.8 m $\text{Na}_2\text{S}_2\text{O}_8$ was again injected, however without the addition of NaOH. The uplift of the road and the widening of the crack stopped and declined immediately after the amended reagent formula was applied. Originally it was planned to inject 5.3 t of oxidising agents including the gelling agent and activators. Due to the amended reagent formula as a result of the gas formation only 3.4 t of reagents were injected. The schedule for the fieldwork was extremely tight since the injection borehole was located in the middle of a main road which was blocked for bus and public traffic for only two weeks.

4.2 Additives

Guar Gum was selected as a gelling agent and viscosifier.
10% NaOH was added as activator.

4.3 Injection type

Remediation reagents were injected under pressure (hydraulic fracturing) in the main contaminated area between 6.2 m and 10.5 m depth via one injection borehole using the direct push system in one campaign. A total of 2.53 t of solid reagents ($\text{Na}_2\text{S}_2\text{O}_8$, "PS" and KMnO_4 , "PM") without additives were injected.

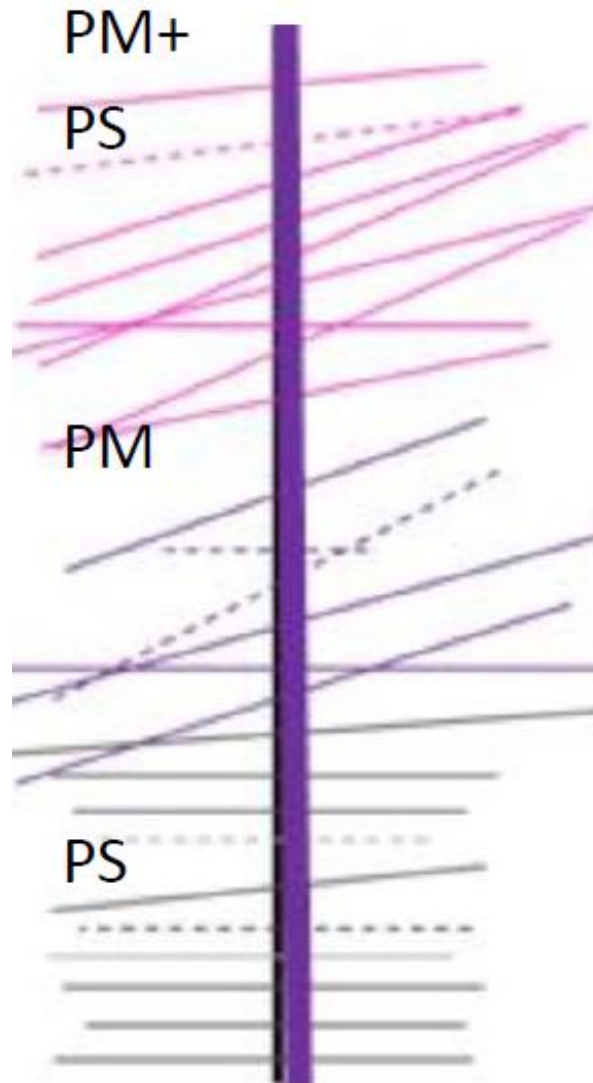

From 6 m bgs to 7.5 m bgs a mixture of solid permanganate and persulfate was injected. This was probably the first time when both agents were injected simultaneously. Thereafter, only solid permanganate was injected. The loading ranged from 150 to 250 kg per frac. From 9 m depth onwards only persulfate solution (50% concentration) was injected.

Our evaluation concluded that the reaction kinetics of persulfate and permanganate reached similar oxidation effects. However, the necessity of persulfate activation and its presumably lower diffusivity added additional complexity.

Mainly horizontal injection layers were generated in a vertical distance of mainly 0.15 m (see picture). Spatial monitoring of the artificially generated fractures was done using tiltmeters which were placed on the road's surface. A live evaluation of generated tiltmeter data allowed the on-site determination of each fracture with respect to its dip and strike. Later evaluation allowed the determination of the fracture thickness and lateral extent.

Measurements of the groundwater potential at three groundwater monitoring wells located around the injection borehole, indicated that existing fissures were (re)activated and thereby filled with reagents. This was also proven from real-time monitoring of the injection pressure data.

It could also be shown, that the generation of the 25 fractures increased the permeability at the area affected by the pilot test, which means that the groundwater flow locally (horizontally and vertically) became faster, which in turn positively influenced the distribution of the emplaced reagent afterwards.

It could be analytically proven that 25% of the injected KMnO_4 was still available in the subsoil two months after the injection. After nearly two years of monitoring it could be shown that a one-time injection of the remedial agents was enough to reach the remediation goals in the pilot test area.

4.4 Radius of influence

The following calculations are based on the evaluation of the tiltmeter data (also see next section):

Over the entire depth of injection approximately 70% of the fractures show dip angles of less than 20° and only 30% of the fractures dip $< 45^\circ$.

The average thickness of the fractures was estimated to about 12 mm. The aspect ratio is $\frac{3}{4}$ indicating that in line with the acting geotechnical stresses, ellipses instead of circles were formed. Compared to the radius of influence projected (5 m radius meaning 10 m in diameter) the calculated radii of influence for the $\text{Na}_2\text{S}_2\text{O}_8$ at depth is below the radii of influence of the permanganate application due to its soluble state and larger leak-off into the surrounding soils during injection. The permanganate only injection and the mixture of permanganate and persulfate reached about a 4.5 m extent in one direction. The calculated radius of influence was proven by the results of the sampling of the liner bores (see picture below), which were spatially placed at the tip of the planned injection coverage.



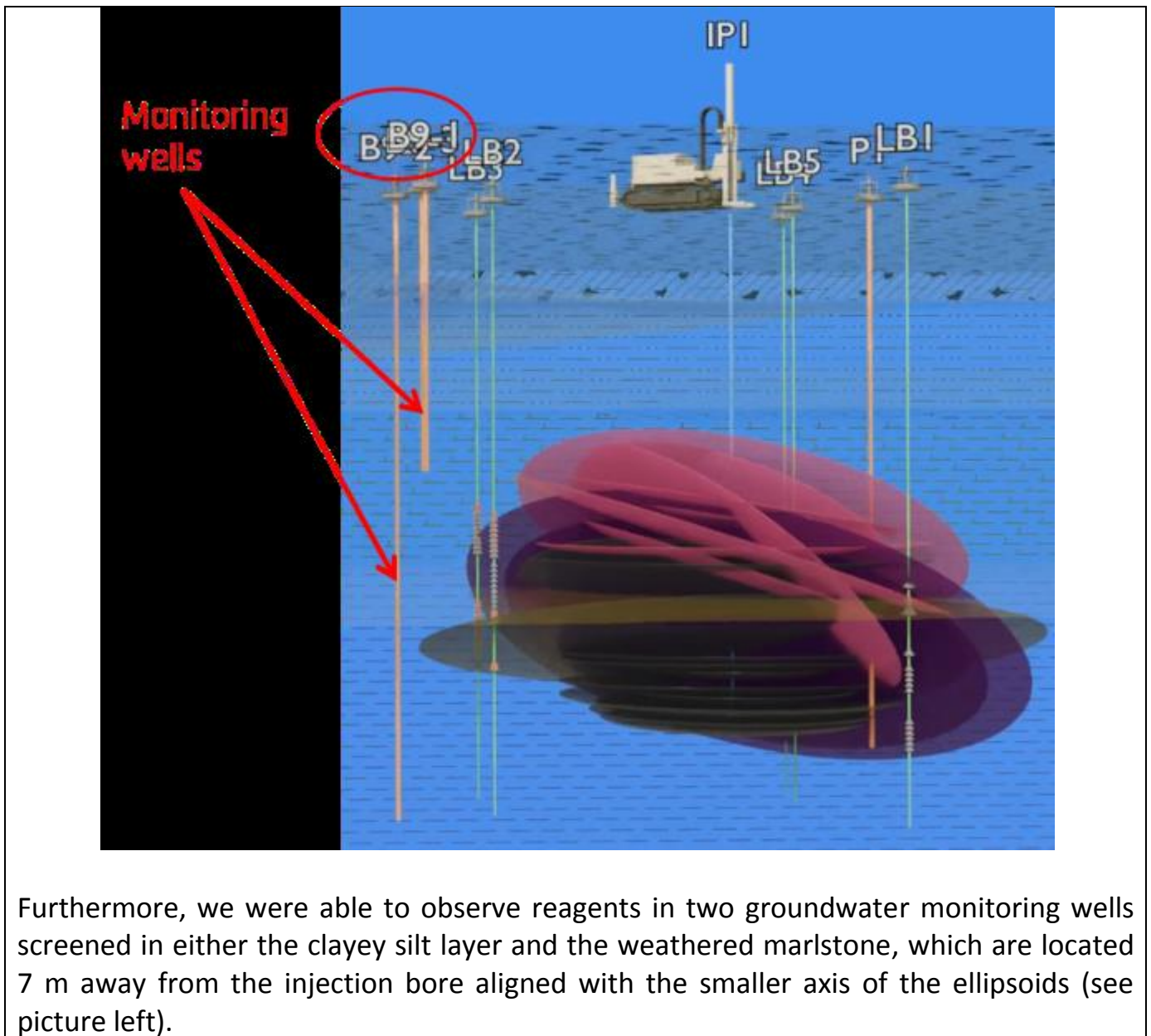



4.5 Control parameters

We recommend analysing for:

Soils (also from leachates as needed):

- CVOCs; here:
- Tetrachloroethane, Trichloroethane, cis-1,2-Dichloroethene, trans-1,2-Dichloroethene, Vinyl chloride, 1,1 Dichloroethane, 1,2 Dichloroethane, 1,1,1 Trichloroethane,
- dissolved iron, dissolved manganate, aluminium,
- Sodium, potassium, sulfate
- pH
- TC, TIC, TOC
- SOD.

Groundwater:

- CVOCs; here:
- Tetrachloroethene, Trichloroethene, cis-1,2-Dichloroethene, trans-1,2-Dichloroethene, Vinyl chloride, 1,1 Dichloroethane, 1,2 Dichloroethane, 1,1,1 Trichloroethane,
- CVOC Isotopes (C12/C13)
- anions, cations dissolved iron, dissolved manganate
- heavy metals
- chloride, and carbonate hardness.

5. Full-scale application

5.1 Main Reagent

Currently only a pilot scale application was performed. However, the results showed that there is no need for a full scale application for the achieved radius of influence in the pilot test area.

6. Post treatment and/or Long Term Monitoring

6.1 Post treatment and/or Long Term Monitoring

Two months after the injection of the reagents verification liner borings at five locations within the radius of influence were drilled. The liner borings (LB) showed the locations of most of the fractures via visual prove of pink (permanganate) and white (persulfate) discolouration.



Comparisons of CVOC concentrations in soil samples before the reagents were injected with CVOC concentrations in soil samples after the injection showed concentration reductions and concentration increases in various depths. We attribute these



discrepancies to the heterogeneity of the CVOC concentrations and the distance to the borehole where the baseline samples were taken from.

Interestingly, the analytical results of Na, SO₄, and K show a clear correlation of the increased concentrations at the depth ranges where persulfate and permanganate were injected.

For monitoring and evaluation purposes of the remediation success groundwater samples were also taken from three groundwater monitoring wells around the injection bore immediately before the injection starts and within 18 months after injection on a bimonthly basis. The following parameters were analysed: Tetrachloroethene, Trichloroethene, cis-1,2-Dichloroethene, trans-1,2-Dichloroethene, Vinyl chloride, 1,1 Dichloroethane, 1,2 Dichloroethane, 1,1,1 Trichloroethane, Isotopes (C12/C13), dissolved iron, dissolved manganese, chloride, heavy metals, anions, cations and carbonate hardness.

Analytical results more than 18 months after injection showed an average 92% decrease of CVOC concentrations in the groundwater at all three monitoring wells with individual reductions between 80 % and 98% compared to the concentrations before the injection of the reagents.

The ratio between groundwater flux and mass reduction showed that the groundwater mass flux reduction is at least twice as high compared to the mass reduction in the soil after the injection of 3.4 t of oxidising reagents nearly two years ago.

7. Additional information

7.1 Lesson learnt

The presumed heterogeneity of the soils beneath the site is limited to about 20% variance. The presumed heterogeneity was caused by the presence of a natural fissure system, which could be proven by contaminant transport modelling. As a consequence, the previously existing conceptual site model was significantly enhanced, paving the way for a successful pilot test.

SOD analyses revealed that a high natural soil oxygen demand prevails at the site, which would in most cases have meant that ISCO would not be applicable as a remedy for the site. However, intensively evaluated data analyses also for kinetic parameters have led to a 2D numerical diffusion model (see Section 3.1) which showed that ISCO is a feasible remedy that can achieve remediation targets. A 10 cm fracture distance can achieve complete oxidation of the contaminants between the fractures. Consequently, verification bores should be placed not earlier than 4 months after the injection was completed.



Stringent injection data analyses were able to demonstrate not only the 3D-position of the fractures in the subsurface, but also the filling of the natural fissure system with the oxidative agents.

Mass-flux-reduction/mass-removal behaviour is a key indicator for sites with high groundwater concentrations and the existence of the natural fissure system as the mass-transfer process is rate limited. We were able to demonstrate that at the site there is no 1:1 ratio between mass-flux-reduction and mass-removal; instead we found a 2:1 ratio. This means that a significant mass flux reduction can be achieved by partial removal of contaminant mass from presumed DNAPL sources.

The ISCO pilot test using hydraulic fracturing as an emplacement method showed that a 50% reduction in contaminant mass achieved a 92% groundwater mass flux reduction.

A further outcome of the pilot test was that at the site persulfate activation is barely controllable for both the combination of permanganate and persulfate, and persulfate only. Uncontrolled persulfate activation in low permeability site coupled with the use of viscosifiers can lead to rapid gas development. The escape route of the produced gas can be limited by the low permeability of the soils.

Specific activation guides for persulfate are absent which would enable a safer handling of persulfate in high concentrations in low permeability environments coupled with a variety of metal oxides in the subsurface.

For a successful emplacement of oxidisers by means of hydraulic fracturing the diffusion coefficient plays a crucial role. The diffusion coefficient permanganate appears to be three orders of magnitude larger than the one for persulfate. Therefore, for the full scale application it was recommended to inject permanganate only.

7.2 Additional information

- The utmost importance for the successful completion of this pilot test was the fact that the client was convinced that a sound investigation phase and a proper and detailed evaluation period is a key factor. Without the applied scientific approach, both from the client and its consultant, this project would have been buried two months after injection, when the results of the liner bores first came to light and the CVOC reductions were well below the expectations.

Other factors were:

- There is a large difference between stoichiometry and kinetics especially for sites where very high concentrations (30-80%) of oxidisers are emplaced. This process should not be overlooked. Using kinetic information can lead to a remediation of site with very high SOD.



- Ambiguity exists for diffusion coefficients of persulfate especially when the activation energy is taken into account. Excess activation and oxidizable matter can lead to rapid gas development, which in low permeability environments must be controlled.

7.4 Additional remarks

Apply science and do not rely on gut-based comments from practitioners. Perform in-depth analyses for every process – even the ones you haven't specifically targeted for or were not on the radar screen.

Most tools are already available, for specific questions one might have to go the extra mile. It pays off in the end.

1. Contact details - CASE STUDY: ISCO n.15

1.1 Name and Surname	Edel, Hans-Georg
1.2 Country/Jurisdiction	Germany
1.3 Organisation	Züblin Umwelttechnik GmbH
1.4 Position	Manager R&D
1.5 Duties	In-situ remediation technologies, PFAS remediation, others
1.6 Email address	hans-georg.edel@zueblin.de
1.7 Phone number	+49 7145 9324-249

2. Site background

2.1 History of the site: Challenges and Solution



Drilling work for the remediation wells in front of building 25/1

The project site, which has been in industrial use for some 90 years, exhibited massive contamination of the groundwater in the Keuper gypsum. The CVOC concentrations, whose origin could not be identified despite extensive investigation, peaked at 50 mg/l. Remediation was required in order to avoid further spreading of the contamination and minimize the hazard to the lower groundwater horizons. A number of different site-specific factors – e.g. the complex hydrogeological conditions and the continued use of the contaminated area as a customer centre – had to be taken into account.

Within the framework of a feasibility study on groundwater remediation various methods were examined in detail. They had to satisfy the following site-specific factors:

- Deep-lying fissured aquifer



- Extensive spread of the contamination plume through built-over area
- Consideration for the use of the affected works area as a customer centre with some
- 600 customers every working day
- Risk of so far undetected old explosive devices in the subsurface resulting from several bombardments of the works site and the former airfield during World War II.
- Multiple branched network of supply lines and sewer conduits

The feasibility study examined a number of innovative remediation. As a result of the study, in situ chemical oxidation was recommended as the method that can be most effectively implemented in compliance with the given site-specific factors. Apart from the site-specific reasons, it was decisive for the selection of this method that the high contaminant concentrations in the groundwater could potentially be effectively reduced within a relatively short period of time, thus decreasing the existing contaminant and hazard potential.

2.2 Geological and hydrogeological setting

Geological subsurface conditions

The area of investigation lies in the northeast to southwest valley plain of two watercourses.

These two brooks were rerouted in the 1970s and partly buried in underground conduits. The natural subsurface is composed of Quaternary valley deposits, interlocking in some areas with mud. The Quaternary deposits consist of a very variably structured sequence of clay, silt, sand, and fine gravel, interspersed with 0.5-3.0 m thick layers of peat, as well as of mixed-grain mud fractions. The thickness of the Quaternary deposits ranges from approx. 3.5 m to 15.0 m.

The figure below is a schematic cross-section in west-east direction through the investigation area, also showing the depression. Further down lies the stratigraphic sequence of the Keuper gypsum, encompassing the units dark red marl, Bochsinger horizon, and gypsum bottom layers. The dark red marls are mostly reddish-brown, clayey silt soils with individual leached gypsum residues and friable, layered silty claystones.

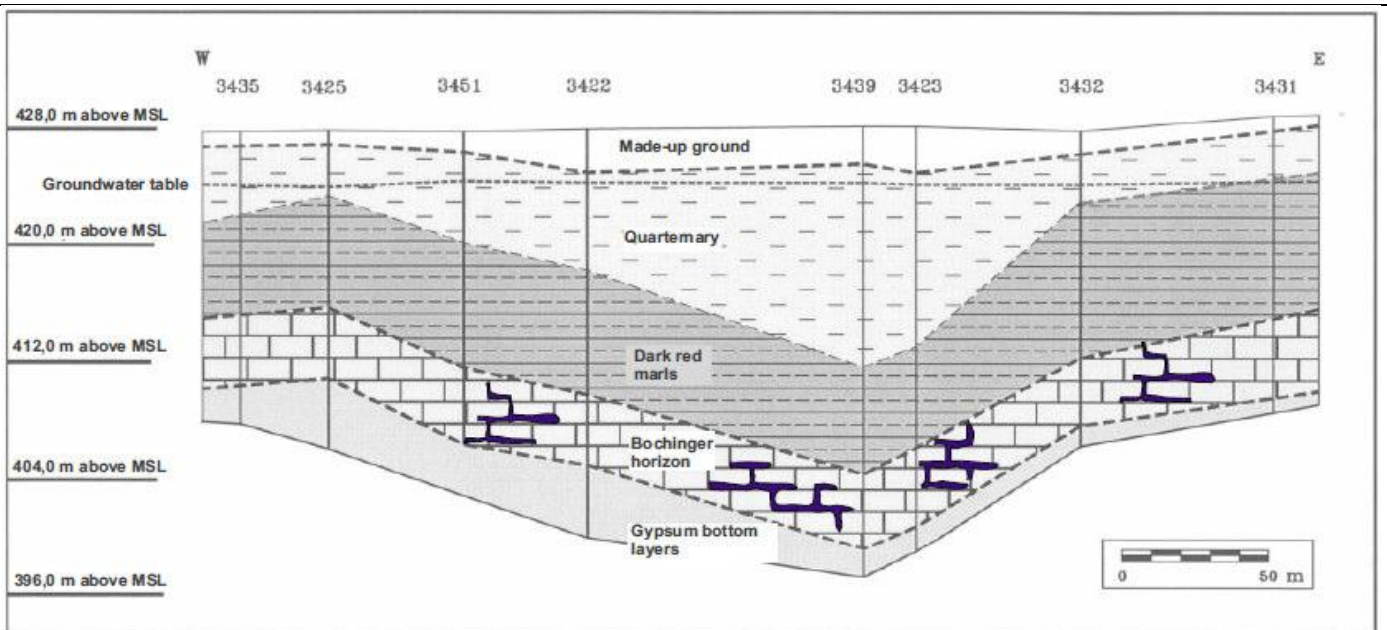

Geological cross-section in west-east direction, schematic

The layers of the underlying Bochliger horizon are composed primarily of claystones and silty claystones with leached gypsum residues and dolomitic beds. In the boreholes the thickness of the Bochliger horizon is between 4.6 m and 5.8 m. Further down the Bochliger horizon is succeeded by extensively leached gypsum bottom layers consisting of silty claystones incorporating numerous leached gypsum residues as well as residual silts and marly beds.

Towards the east and southeast there are also thicker gypsum layers. Gypsum leaching can produce cavities which are reproduced by the overlying layers. In the area of the contamination centre a doline-type structure with its lowest point near monitoring points GWM 3423 and GWM 3439 was encountered.

Hydrogeological conditions

The investigation area shows two groundwater storey formations across the subsurface range explored by drilling. The upper groundwater horizon lies in the Quaternary valley deposits of the two brooks. Because of the interstratified subsurface structure with cohesive, peaty and sandy gravelly soils, the permeability conditions vary greatly, as ascertained by short pumping tests.

The Keuper gypsum layers generally show a layered and fissured aquifer system where the groundwater circulates in individual zones of increased permeability. In the investigation area, the groundwater within the Keuper gypsum sequence is carried mainly in the Bochliger horizon which has been accessed through the groundwater monitoring points installed.

The Bochliger horizon is characterized by a relatively high permeability (k_f value 10^{-4} m/s)



and a high yield. The groundwater circulating there is hydraulically confined. The top edge of the Bochinger horizon was encountered at depths between 12.6 m and 23.6 m below ground level; the piezometric groundwater surface lies between approx. 3.5 m and 4.5 m below ground level.

In general, the direction of groundwater flow in the eastern section of the works site runs from east to west and then turns southwest to the south of the investigation area.

However, locally one must expect differing flow directions and a highly variable flow pattern.

2.3 Contaminants of concern

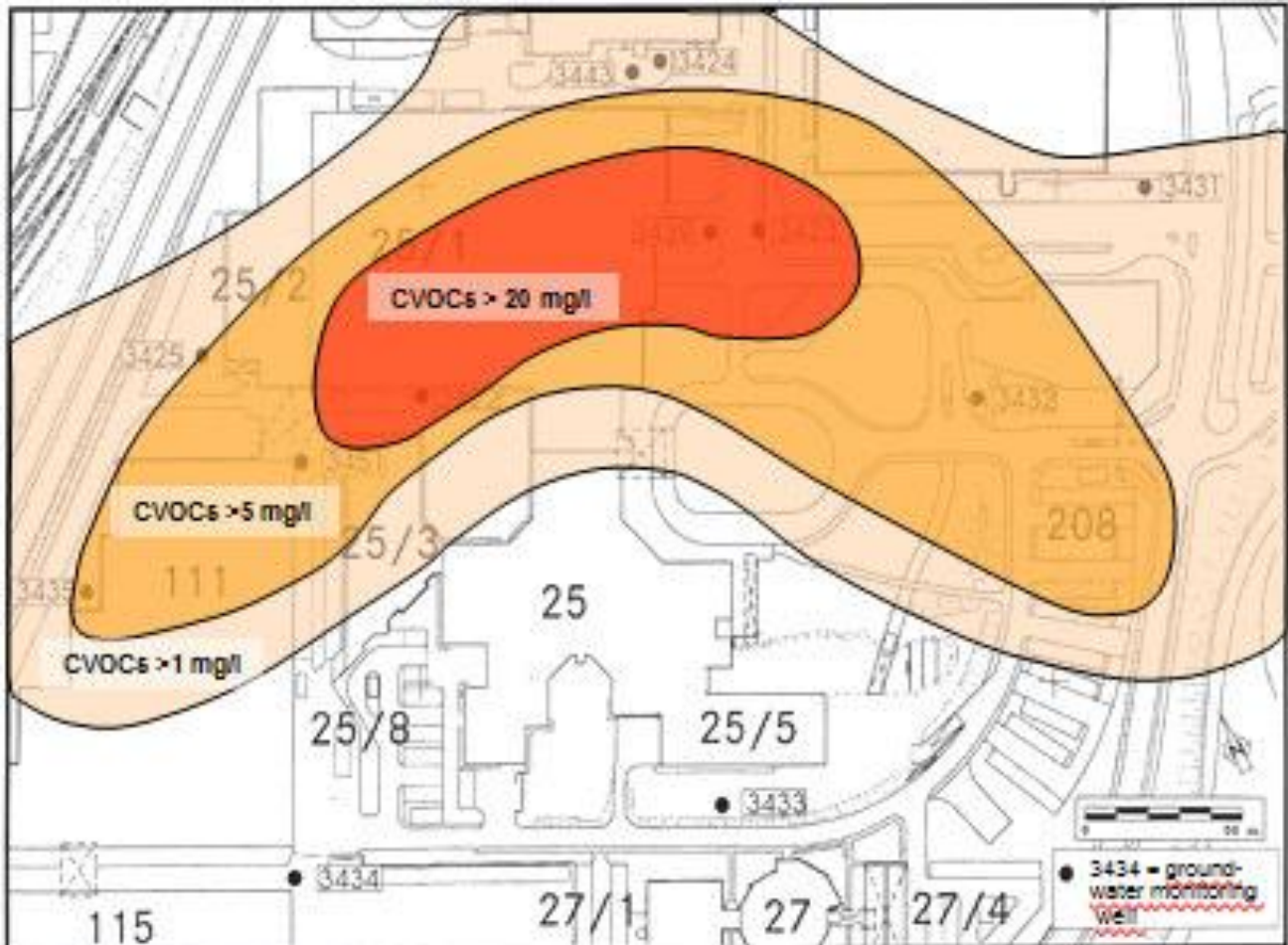

Contaminant distribution based on groundwater modelling before the start of remediation work in 2005

Contaminant distribution in the groundwater

On the basis of the drillings and investigations performed, it was possible to largely delimit the lateral contaminant distribution, which extends in the contamination centre over an area of approx. 5,000 m². The groundwater showed a clear CVOC maximum with concentrations from 30 to 50 mg/l in the region of monitoring points 3423 and 3439 on the eastern side of building 25. The contaminant spectrum was dominated by PCE which makes up approx. 80-90% of the CVOC total. Ranking secondary were TCE and cDCE as well as 1,1-dichloroethylene (1,1-DCE) and VC.

The drilling results from the actual investigation area, the works premises and the surroundings supplied the data for developing a groundwater model of the Keuper



gypsum aquifer at the Sindelfingen site. This model served to simulate the contaminant distribution in the investigation area using analytical findings from fixed-schedule sampling. The modelling result showed a contamination plume extending from east to west and turning southwest underneath building complex. In the downgradient flow further southwest, the contaminant concentrations were found to be reduced to 2-5 mg/l CVOCs.

With the isotope analyses it was established that the TCE and cDCE components found in the investigation area were direct by-products of the reductive dechlorination of tetrachlorethylene and not separately introduced contaminant components.



2.4 Regulatory framework

Remediation permit and other legal aspects

With innovative remediation schemes in particular – here the full-scale application of the in situ chemical oxidation (ISCO) method for the first time in Germany – it is advisable to negotiate a public law contract, making it possible to regulate complex matters within the framework of a cooperation agreement. The preamble expressed the will of the contractual parties to undertake the required remediation, and thus defined a starting point for potential contract interpretations or changes at a later date. The contract also laid down the procedure, the cleanup implementation, the monitoring measures, and the contract adaptation or termination in specific cases. In addition, the contract covered steps for a possible change concerning the method, special control mechanisms, and the establishment of a project group. Because of the novelty associated with the chosen remediation method, it was contractually agreed to publish the procedure and provide a special documentation. The water resources permit was granted taking into account all aspects for the withdrawal of groundwater and the introduction of the oxidant. It was further contractually stipulated that the fundamental effectiveness of the method should be checked on site by corresponding laboratory and field tests, and that the applicable criteria for the dosing of the oxidant should be determined with a view to the soil properties in the aquifer. The mode of action of the ISCO method was to be checked by means of a remediation test, and the required peripheral conditions with respect to occupational health & safety, well location density and oxidant injection modalities were to be optimized. Due to the positive results obtained, a permit was granted for the remediation of the Keuper gypsum aquifer.

<i>Year</i>	<i>Measure</i>
<i>May 2003</i>	<i>Laboratory test</i>
<i>Sept. 2003</i>	<i>Injection test</i>
<i>Oct. 2003</i>	<i>Pilot-scale test</i>
<i>May 2004</i>	<i>Remediation test</i>
<i>Sept. 2005 – May 2008</i>	<i>Source remediation</i>
<i>Since June 2008</i>	<i>Monitoring programme</i>

Before being able to commence with the groundwater cleanup activities at the site, using the in-situ chemical oxidation method, it was necessary to carry out a step-by-step check of the suitability of the ISCO method under site-specific conditions. Ever since the conclusion of the source remediation in May 2008, a monitoring programme has been in place.

3. Laboratory-scale application in field

3.1 Laboratory scale application

Chemical laboratory analyses of groundwater samples from the highly contaminated monitoring point GWM 3423 were performed in preparation for a field test.

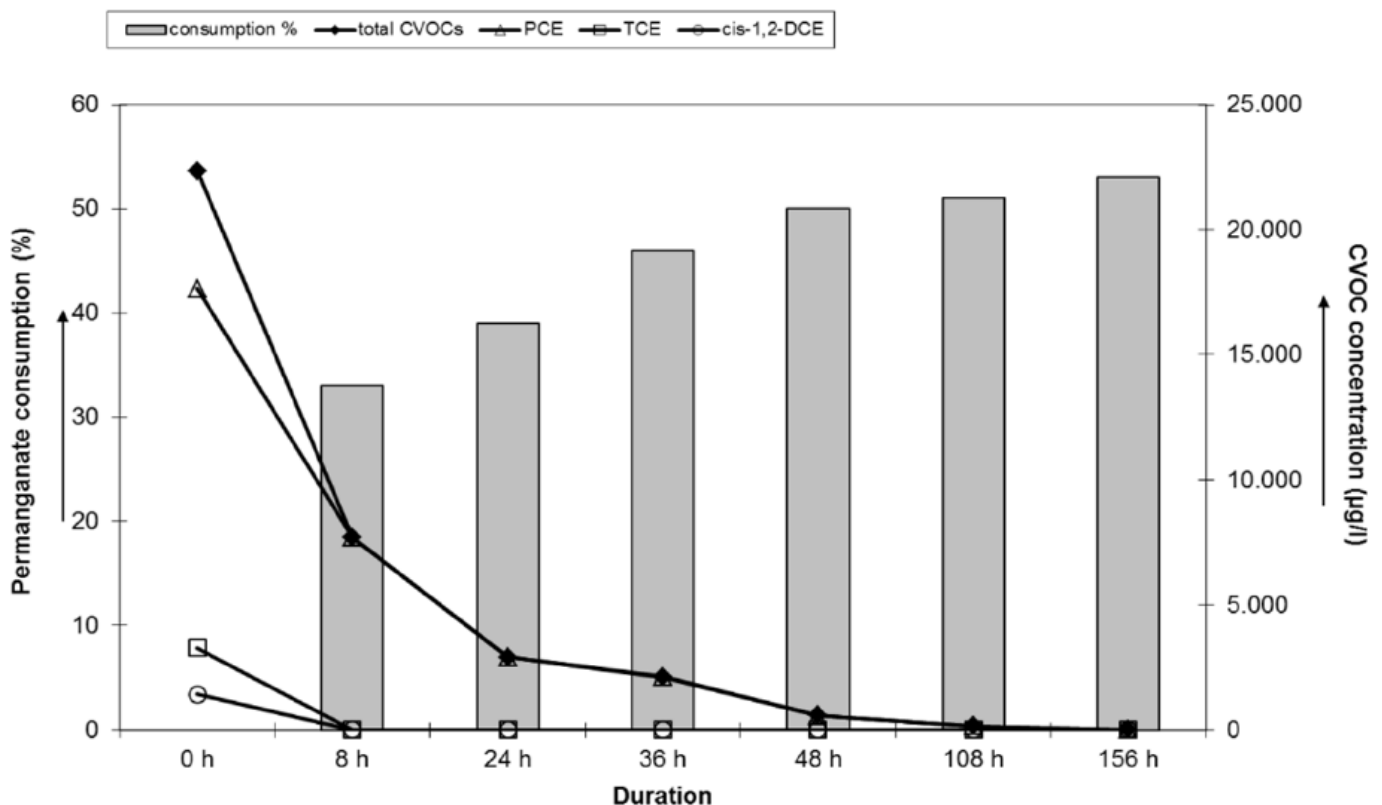

Laboratory test, oxidation of CVOC contaminated groundwater from monitoring point GWM 3423 using permanganate

The figure represents an example of a concentration curve of a measurement series with a permanganate concentration of 80 mg/l.

After only 8 hours the original CVOC content was degraded by almost 70%. The last measurement after 156 hours merely showed a concentration of 6.5 µg/l CVOC. Accordingly, the chlorinated ethylenes (PCE, TCE, cDCE, VC) were almost completely oxidized; this was however not the case with the chlorinated ethanes (1,1-dichloroethane and 1,1,1-trichloroethane) which were only present in low concentrations. In agreement with the literature (ITRC, 2006), the results show that low-chlorinated ethylenes are oxidized faster than higher chlorinated ones. The fast degradation was also promoted by a very low organic content of 2.0 to 3.5 mg/l TOC in the groundwater sample.



4. Pilot-scale application in field

4.1 Main treatment strategy

Pilot scale test

After the positive laboratory findings, the next step consisted of a pilot-scale test in the investigation area as a preparation for the ISCO cleanup of the groundwater using permanganate. It involved an injection test at monitoring point GWM 3424 and the actual pilot scale test with permanganate injections at monitoring points GWM 3423 and GWM 3424 as well as a four-week pumping measure at groundwater monitoring points 3422 and 3425 simultaneously.

The injection test showed that the groundwater level in the well rose in the case of permanganate injection compared to injection with ordinary water. The cause may possibly be that oxidation reactions in the filtration area already occurred during injection, so that reaction products hampered the outflow of the infiltrate. Moreover, the greater viscosity of the injection solution, compared with water, may also have been a reason for the rise in the water level.

The objective of the pilot-scale test was initially to test the method's basic mode of action at the site. Furthermore, it was to be checked to what extent the permanganate injected at monitoring points 3423 and 3424 could be distributed underneath building 25 by means of pumping measures in the downgradient monitoring points 3422 and 3425, in order to remediate the building area not directly accessible through drilling.

During the five-week pilot-scale test a total of approx. 1,390 kg MnO_4^- – in the form of sodium permanganate – was introduced into the contamination centre via the two monitoring points 3424 and 3423. To prevent uncontrolled drifting of the permanganate, approx. 7.5 m³/h of groundwater was abstracted in the downgradient flow at the two wells GWM 3425 and GWM 3422. The water was then cleaned in a mobile stripping plant down to CVOCs < 10 µg/l and discharged into the sewer system.

Accompanying the tests was an extensive monitoring programme carried out at a total of eight wells. The parameters CVOC, Mn^{2+} , Na^+ , Cl^- , pH value, temperature, conductivity, and redox potential were measured at regular intervals at monitoring point 3439, which lies closest to the injection monitoring points, and at the two extraction wells. The other monitoring points were sampled before the start and after the end of the test phase, in order to assess the impact on the further surroundings.

It was found that the CVOC concentrations fluctuated. After injection of permanganate the contaminant levels were at first clearly reduced, only to increase later. The increase is most likely due to the subsequent inflow of contaminants into this area. In general, the results were inconclusive and could not be fully interpreted because of the rather large

test area.

Remediation test

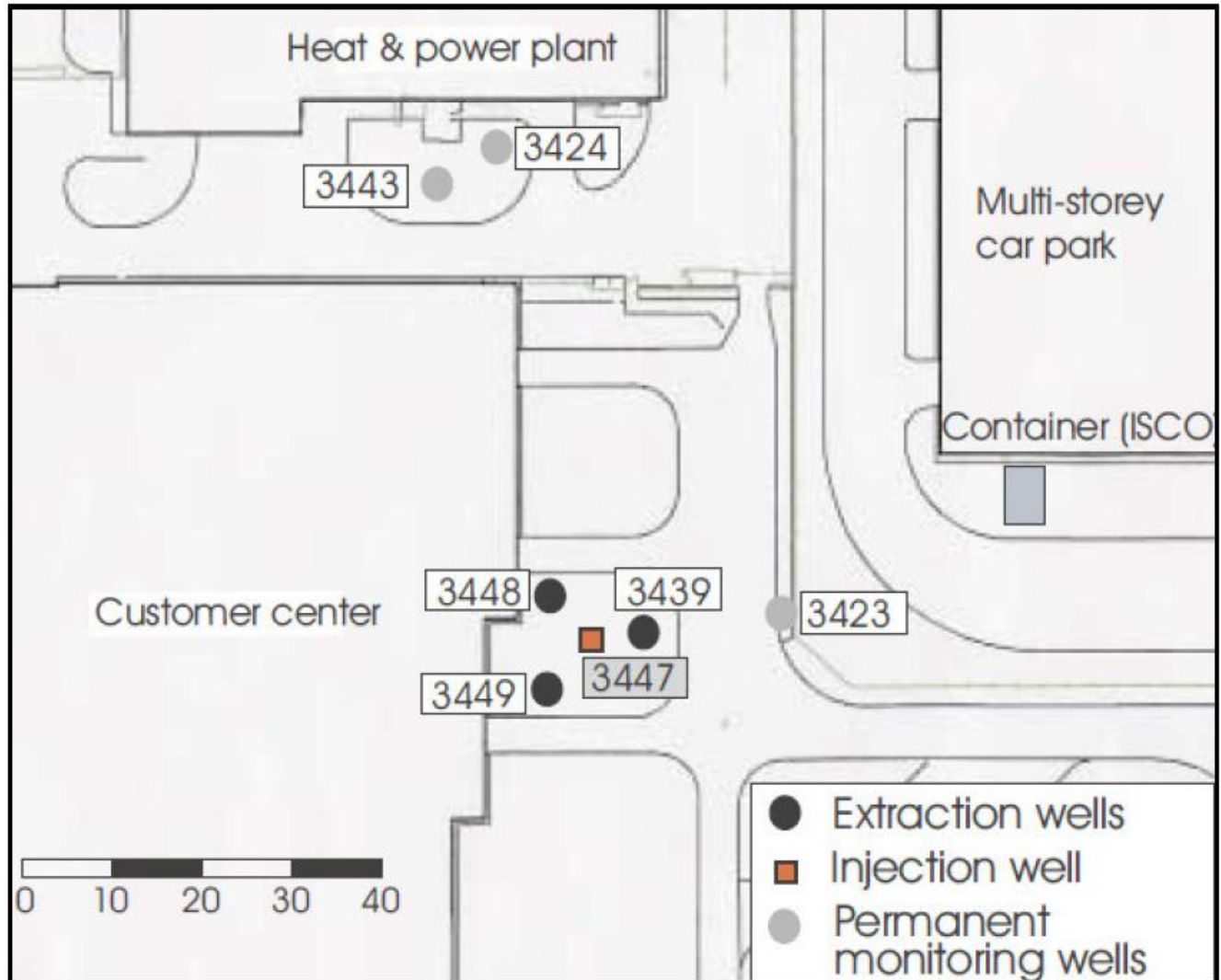

Layout plan of the test site with location of groundwater monitoring points

While the pilot-scale test in autumn 2003 covered a large area, the remediation test was carried out in a relatively small green area directly adjacent to building 25/1. The objective of the remediation test was to gain further insights with a view to the technical application of the ISCO method at this particular site. Firstly, significant oxidative destruction of CVOCs was to be proved; secondly, it was to be investigated how an optimum distribution and dosing of the oxidant in the subsurface could be implemented. Furthermore, it was to be tested to what extent the technical measures (drilling, pipe laying, etc.) would be acceptable in the area of the customer centre without undue disturbance.

The test concept envisaged the provision of a closed circulation system where the groundwater would be pumped off, enriched with permanganate and then reinfiltreated. The remediation test was also studied within the framework of a diploma thesis.

The test site comprised a small area of some 400 m² with the central groundwater monitoring point GWM 3447 used as an injection well and the three groundwater monitoring points GWM 3439, 3448 and 3449, which form a star pattern, serving as extraction wells. This arrangement and mode of operation were intended to ensure that the permanganate is distributed across the area without uncontrolled migration. The average circulation rate of the groundwater amounted to approx. 2.8 m³/h. In total, about 1.4 t of permanganate with a concentration of approx. 500-1,000 mg/l was injected and about 3,800 m³ of groundwater was recirculated in the aquifer of the test site. The permanganate was injected over a period of six weeks. After termination of the permanganate injection the test facility was run for another three weeks. Before, during and after the test, groundwater samples were analysed for CVOCs, and on-site measurements were performed with regard to the pH value, temperature, conductivity, and redox potential. Manganese, sodium and chloride were analysed as additional parameters. Furthermore, samples were taken regularly and examined photometrically in the laboratory for their permanganate content. The table presents a comparison of the CVOC total concentrations at the start of the test compared to two and fourteen weeks after the end of the test.

Time period t[d]	CVOC total concentrations [mg/l] percentage (%)			
	GWM 3439 extraction	GWM 3448 extraction	GWM 3449 extraction	GWM 3447 injection
t = 0 d	37.3 (100%)	34.2 (100%)	34.3 (100%)	35.1 (100%)
t = 77 d	22.5 (60.3%)	22.8 (66.6%)	17.6 (51.3%)	15.5 (44.2%)
t = 162 d	20.7 (55.5%)	16.1 (47.0%)	19.9 (58.0%)	2.71 (7.7%)

Contaminant concentrations at the groundwater monitoring points of the remediation test during the period t = 0 d to t = 162 d

The contaminant reductions achieved within only five months are quite remarkable. However, without further remedial measures the contaminant concentrations would presumably have risen again due to the inflow of groundwater with higher pollution levels.

The parameters pH value and redox potential (Eh), which were measured on site, showed a clear reaction directly after the injection of permanganate and proved to be suitable indicators for the CVOC oxidation processes occurring in the subsurface. By contrast, the



measurements of conductivity and temperature did not find any significant changes. In tandem, a sample from GWM 3439 was examined for possible by-products by means of LC-MS screening (U.S. DOE., 2000). Initially, the findings showed glyoxylic acid with 0.12 mg/l, hydroxyacetic acid with 0.04 mg/l and oxalic acid with 0.46 mg/l. This screening was repeated 4 months later using another sample from the same monitoring point, in order to be able to assess the potential long-term accumulation of these acids. Here, the concentrations were below the respective determination limit of 0.05 mg/l for glyoxylic acid as well as 0.1 mg/l for hydroxyacetic acid and oxalic acid. With the exception of the existing CVOCs, chlorinated organic compounds, such as trichloroacetic acid, were not detected.

4.3 Injection type

- Existing groundwater monitoring wells (GWM) were used for injection of permanganate and for establishing a groundwater circulation (cf. chapter 4.1 Main treatment strategy, Remediation test).
- The distance between injection and extraction wells was about 10 m.
- Permanganate solution was injected into the Bochinger horizon in a depth of about 15-25 m bgl.
- The permanganate was injected continuously over a period of six weeks. After termination of the permanganate injection the test facility was run for another three weeks.
- Sodium permanganate was used as ISCO agent. In total 1.4 t MnO_4^- with a concentration of approx. 500-1,000 mg/l were injected.

4.4 Radius of influence

The distance between the injection and extraction wells was about 10 m. The establishing of a circulation system was verified by tracer tests using the rising conductivity caused by injection of sodium permanganate.

The radius of influence is regarded higher than 10 m since there are another 10 m radius of influence around the extraction wells.



4.5 Control parameters

Before, during and after the test, groundwater samples were analysed monthly for CVOCs, and on-site measurements were performed weekly with regard to the pH value, temperature, conductivity, and redox potential. Manganese, sodium and chloride were analysed as additional parameters twice. Furthermore, samples were taken regularly and examined photometrically in the laboratory for their permanganate content. In tandem, a sample from GWM 3439 was examined for possible by-products by means of LC-MS screening (U.S. DOE., 2000). Initially, the findings showed glyoxylic acid with 0.12 mg/l, hydroxyacetic acid with 0.04 mg/l and oxalic acid with 0.46 mg/l. This screening was repeated 4 months later using another sample from the same monitoring point, in order to be able to assess the potential long-term accumulation of these acids. Here, the concentrations were below the respective determination limit of 0.05 mg/l for glyoxylic acid as well as 0.1 mg/l for hydroxyacetic acid and oxalic acid. With the exception of the existing CVOCs, chlorinated organic compounds, such as trichloroacetic acid, were not detected.



5. Full-scale application

5.1 Main Reagent

Remediation

Due to the positive test results coupled with the cost and time advantages compared with a pump and treat scheme, the cleanup of the contamination centre was implemented using the ISCO method with permanganate. The relevant public authorities deliberately refrained from laying down a specific cleanup target. However, the objective was to employ the ISCO method in order to reduce the contaminant contents by about 80-90% within 2-3 years. The entire contamination zone extends over an area of approx. 20,000 m², with some 5,000 m² thereof involving the contaminant source. Due to this large size and the limiting site conditions it was not possible to implement the method, as successfully tested, on a 1:1 basis across the entire contamination zone. The ISCO remediation was therefore restricted to the contamination centre located east of the customer centre, so as to achieve an effective contaminant reduction within a short time period and stop the further spreading of contaminants into the downgradient flow, as well as counter the hazard of migration into deeper groundwater horizons. In order to prevent uncontrolled movement of contaminants and permanganate, a pump-and-treat plant was installed as a hydraulic protection measure. This also served to distribute the oxidant over a large area underneath the building. The ISCO remediation in the Keuper gypsum aquifer proceeded in four successive phases. Initially, the cleanup took place in the area of the contamination source directly in front of the customer centre. Over a period of 15 months sodium permanganate was injected, as a dilution, into the upgradient groundwater wells; it was then transported westwards with the natural groundwater gradient. The transport and distribution of the oxidant were supported by groundwater extraction in the downgradient wells located in front of building 25/1. The extracted groundwater was cleaned and used as process water for diluting the 40% NaMnO₄ solution. Phase 2 The subsequent work, carried out over a period of 15 months, focussed on the contamination area underneath building 25/1. Here, a sodium permanganate dilution was injected through the groundwater monitoring points directly in front of building 25/1, and groundwater was extracted from the downgradient flow southwest behind the building. Phase 3 After termination of the phases 1 and 2, permanganate was once more injected through the wells directly in front of building 25/1, in order to create an oxidant pool for the destruction of the remaining CVOC content. Phase 4 In May 2008 the active measures of the ISCO cleanup project were concluded. Since that time a long-term monitoring programme has been running at the

site. If follow-up monitoring should indicate a rebound at individual wells, this will be dealt with by systematic permanganate injections. The groundwater in the downgradient area now contains only comparatively low CVOC concentrations of < 1 mg/l and is being cleaned via a conventional pump-and-treat system. The wells for downgradient protection are sampled at monthly intervals, all the other groundwater monitoring points at the site are sampled every six months and analysed for CVOCs, Mn²⁺ and Cl⁻. It is also planned to repeat the LC-MS screening for by-products.

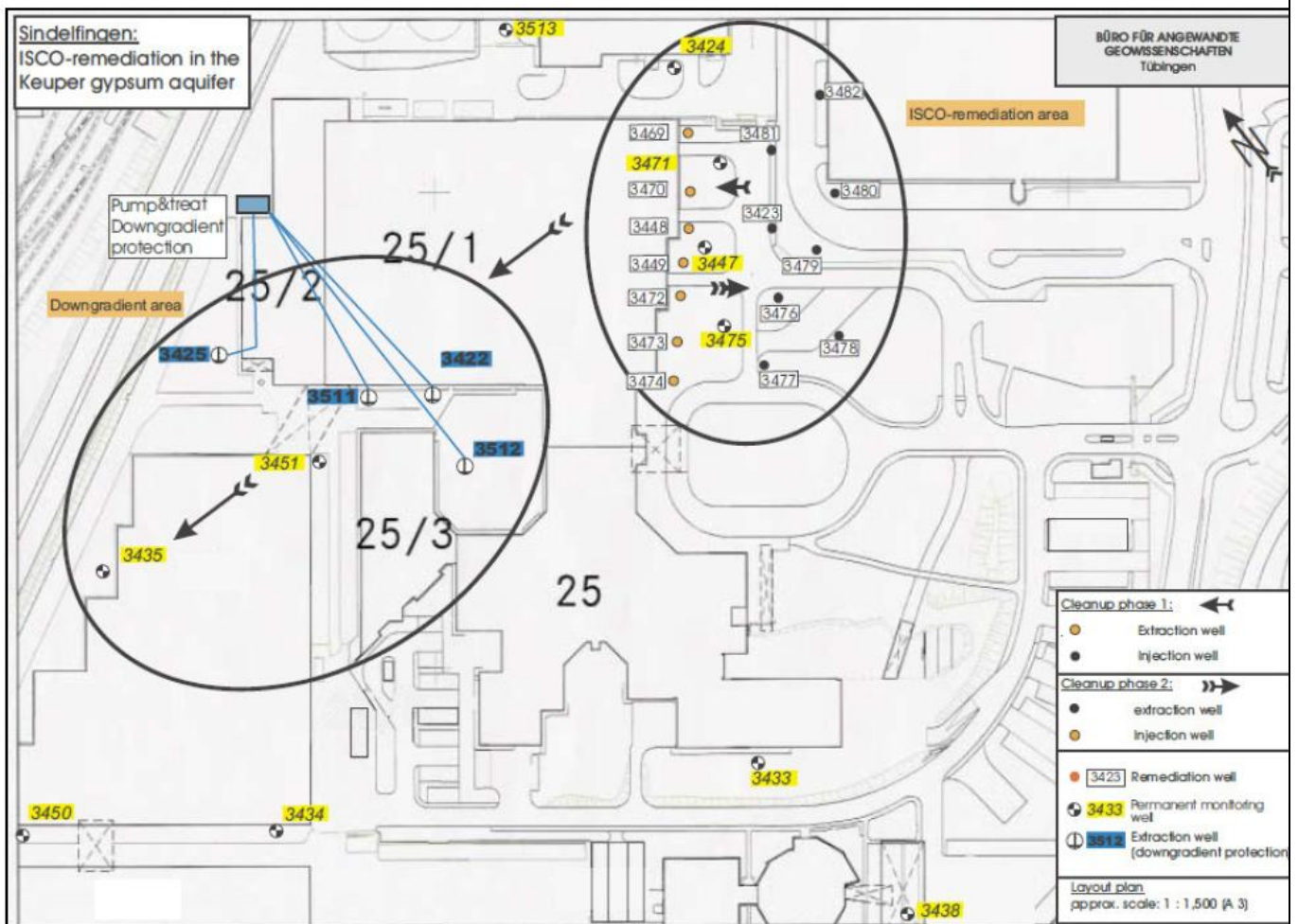

ISCO remediation of the Keuper gypsum aquifer. Layout plan with ISCO cleanup area and downgradient area

Results

In the period from September 2005 to May 2008, a total of 30 tonnes of oxidant was injected, corresponding to the destruction of about 7,500-10,000 kg of CVOCs. This calculation is due to results of the field tests which indicated a specific oxidant demand of approx. 3-4 kg permanganate per kg CVOCs. The figure below depicts the ISCO plant

technology including a dosing station for sodium permanganate.



ISCO plant technology



ISCO dosing station

The project achieved a reduction in the CVOC concentrations at the contamination centre down to approx. 0.1-1.9 mg/l, which equals a mean decrease of around 90-95%. As another positive result it should be noted that, with the exception of one well, there has been no significant rebound of the contaminant concentrations. Reduced permeability in the Keuper gypsum aquifer due to MnO_2 precipitation could not be detected.

The ISCO measure at the contamination centre has also had a positive effect on the downgradient flow. Currently (status 12/2020) the CVOC concentrations in the downgradient wells lie below 0.5 mg/l and have thus been reduced by approx. 85-90%. Consequently, in-situ chemical oxidation also offered economic advantages compared with the conventional pump-and-treat method.

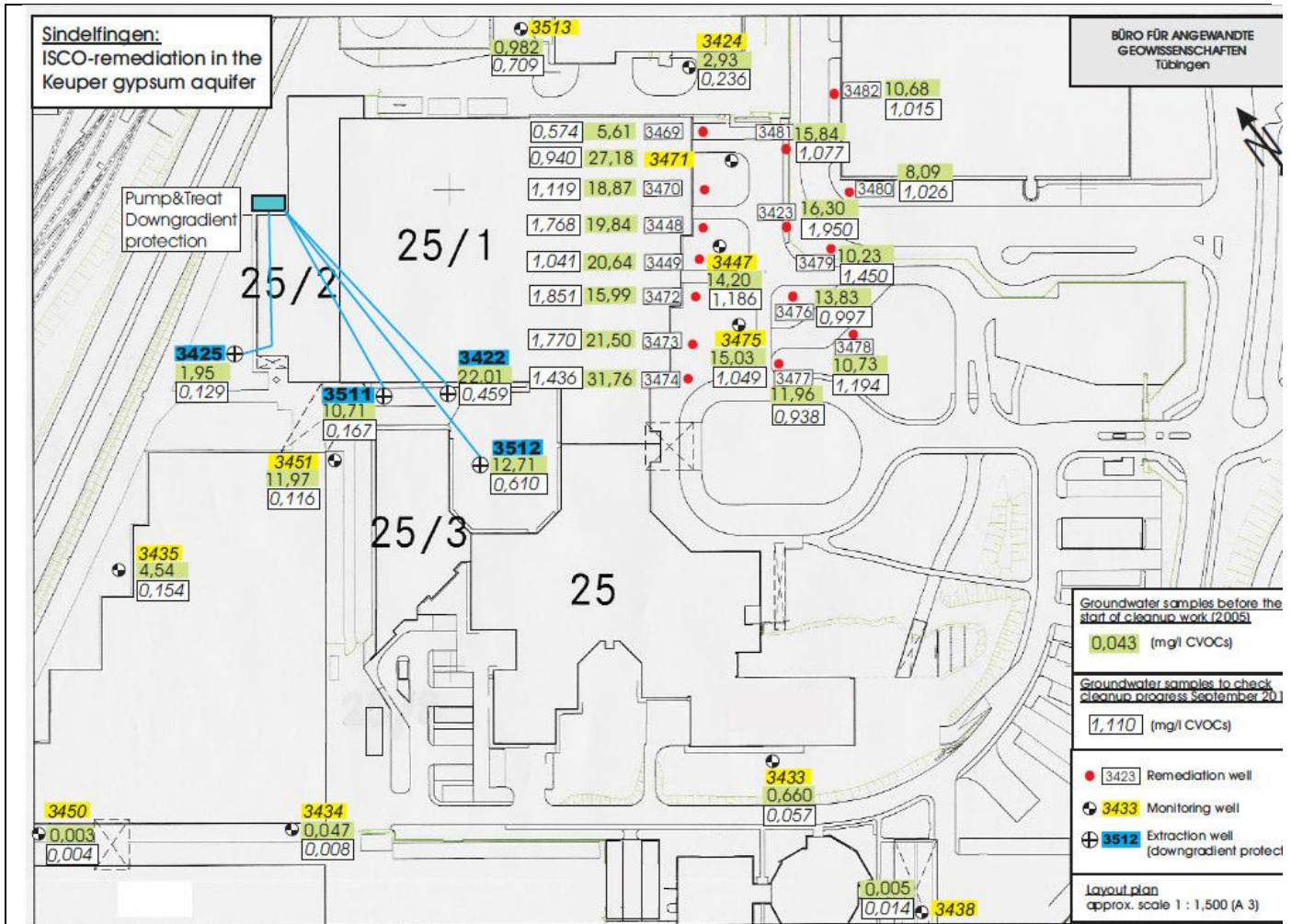

Contaminant concentrations before the start and after conclusion of active ISCO remediation in the Keuper gypsum aquifer (status December 2019)



5.3 Injection type

- Existing wells were used and new injection wells in front of building 25/1 were drilled.
- In phase 2 of the remediation works the new wells were used for ISCO treatment of the contamination area underneath building 25/1.
- Permanganate was injected continuously over a period of 15 months in phase 1 and in phase 2. After termination of the phases 1 and 2, permanganate was once more injected through the wells directly in front of building 25/1, in order to create an oxidant pool for the destruction of the remaining CVOC content. A total of 30 tonnes of oxidant with a concentration of 500 –mg/L MnO_4 was injected in the period from September 2005 to May 2008.

5.4 Radius of influence

The transport and distribution of the oxidant were supported by groundwater extraction downstream. The distance of influence was 50 – 100 m verified by monitoring.

5.5 Process and performance monitoring

The wells for downgradient protection are sampled at monthly intervals, all the other groundwater monitoring points at the site are sampled every six months and analysed for CVOCs, Mn^{2+} and Cl^- . On-site measurements were performed weekly to monthly with regard to the pH value, temperature, conductivity, and redox potential.



6. Post treatment and/or Long Term Monitoring

6.1 Post treatment and/or Long Term Monitoring

Since termination of the active remediation all wells and are sampled twice per year and analysed for CVOCs.

7. Additional information

7.1 Lesson learnt

Difficulties and weaknesses, successes and strengths, keystones, shortcomings and rooms for improvement

The project achieved a reduction in the CVOC concentrations at the contamination centre down to approx. 0.1-1.9 mg/l (status 12/2020), which equals a mean decrease of around 90-95%. As another positive result it should be noted that, with the exception of one well, there has been no significant rebound of the contaminant concentrations. Reduced permeability in the Keuper gypsum aquifer due to MnO_2 precipitation could not be detected. The ISCO measure at the contamination centre has also had a positive effect on the downgradient flow. Currently (status 12/2020) the CVOC concentrations in the downgradient wells lie below 0.5 mg/l and have thus been reduced by approx. 85-90%. Consequently, in-situ chemical oxidation also offered economic advantages compared with the conventional pump-and-treat method.

Outlook

In-situ chemical oxidation is an established and very promising groundwater remediation technology suitable for a wide range of organic contaminants. Among the various in-situ methods, ISCO occupies a prominent market position in Germany and is also increasingly being applied in other European countries. The projects of Züblin Umwelttechnik GmbH implemented so far at more than 40 different contaminated sites have shown that the ISCO method enables a fast reduction of high contamination levels in groundwater. Additionally, the method is also very well suited for minimizing the existing contamination potentials underneath buildings. The direct contact of pollutants and oxidants is the essential prerequisite for a successful application of the ISCO technique. ISCO in a low permeable underground is a challenge but can be realized successfully using specific injection technology (e.g. fixed manchette tubes). However, the ISCO method cannot be applied for all types of contamination involving CVOCs or organic pollutants. Large pools of DNAPL and LNAPL phase cannot be remediated using ISCO. For economic reasons, the method is less suitable for the remediation of extensive



contamination plumes or soils with a very high content of organic substances. The successful application of the ISCO method requires detailed knowledge of the subsurface conditions and the spatial distribution of the contaminants, as well as broad practical experience. Field tests for checking the cleaning efficiency in the aquifer are strongly recommended in case of complex hydrogeological situation.

7.3 Training need

Workshops, training on-the job, webinars, e-learning could be an effective training tool

1. Contact details - CASE STUDY: ISCO n.16

1.1 Name and Surname	Federica Danesin
1.2 Country/Jurisdiction	Italy
1.3 Organisation	ARPAV – Agenzia Regionale per la Prevenzione e la Protezione Ambientale del Veneto
1.4 Position	Professional Technical Collaborator
1.5 Duties	
1.6 Email address	federica.danesin@arpa.veneto.it
1.7 Phone number	+39 041 544 5642

2. Site background

2.1 History of the site: Challenges and Solution

The area subjected to the remediation is into the Porto Marghera Site of National Interest - Venice – Italy

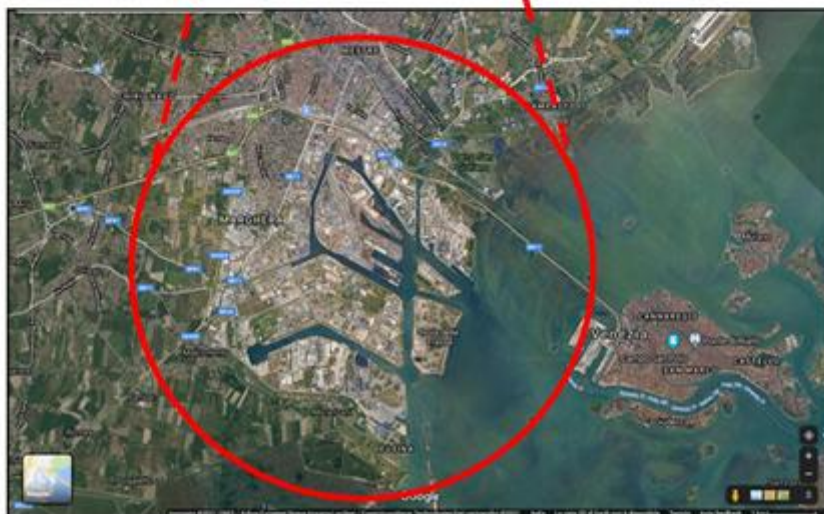



2.2 Geological and hydrogeological setting

- The area subjected by the remediation has a flat surface, at an approximate altitude of 3 meters above the average sea level.
- The surface morphology of the area is the result of the lagoon landscaping carried out in the past to enlarge the industrial area, with the creation of the peninsula now called “Nuovo Petrolchimico”. The sales pitch was aimed at raising and levelling the area to enlarge the industrial area, and is made up of material of a heterogeneous nature, often residues of industrial processing. Within this backfilled material, saturated areas impregnated with water are observed, commonly defined as “groundwater in the backfill” or “backfill impregnation waters”. The absolute altitude of the groundwater level is quite variable and cannot be correlated with each other, making it impossible to identify a real direction of groundwater flow.
- From the ground level to a depth of about 3 meters: heterogeneous fill layer, consisting of coarse material (gravel, tout-venant) in fine matrix (sands, silty sands, silts), used in the past for the raising of the ground level and for the localized filling of the most depressed areas, in order to create the new industrial zone.
- Up to a depth of about 5 meters from the ground level: fill made up of red bauxitic mud or blackish mud. Materials of pasty consistency, compact, of variable thickness within the site, used in the past for the artificial filling of the lagoon sandstone area and the raising of the countryside floor, in order to create the new industrial area.
- Depth of the aquifer of the backfill from the ground level 1.2 m



2.3 Contaminants of concern

Given the nature of the fill and the relative “suspended” aquifer characteristic of the Porto Marghera area, the qualitative state of the environmental matrices is not homogeneous within the site. The characteristics of the very limited area, identified by the LEV06 survey, on which the In Situ Chemical Oxidation (ISCO) technology has been applied, are reported.

The area actually affected by the reclamation intervention is equal to 450 m².

The integrative characterization, carried out in January 2016, also showed exceedances in the S2 and S5 surveys which confirmed the presence of heavy hydrocarbons C> 12 and some polycyclic aromatic hydrocarbons (PAHs). The overall portion of contaminated land is between 3 m and 5 m from the ground level

The contamination was detected between 4 m and 4.6 m deep and it is due to the presence of heavy hydrocarbons C>12, detected in a concentration equal to 837 mg/kg and some PAHs (benzo(a)anthracene 16, 1 mg/kg, benzo(b)fluoranthene 22.5 mg/kg, benzo(a)pyrene 15.3 mg/kg and indeno(1,2,3-cd)pyrene 10.3 mg/kg).

There is no NAPL (Non-Aqueous Phase Liquids)

Qualitative status of the groundwater in the LEV06 piezometer, located near the intervention lot with ISCO:

- Al: 146 µg/l
- As: 44.6 µg/l
- Mn: 42.4 µg/l
- Benzene: 1.38 µg/l
- Vinyl chloride monomer (VCM): 2.47 µg/l
- 1,1-dichloroethylene: 0.00914 µg/l
- Sulphates: 6.63 µg/l

2.4 Regulatory framework

- Italian Legislative Decree 152/2006
- Italian Ministerial Decree 31/2015
- “Accordo di Programma per la Bonifica e la Riquilificazione Ambientale del Sito di Interesse Nazionale di Venezia – Porto Marghera e Aree Limitrofe”



3. Laboratory-scale application in field

3.1 Laboratory scale application

Due to the deep location of the contamination and the heterogeneity of the backfill, no laboratory tests were performed as they were considered not significant.

4. Full-scale application

4.1 Main Reagent

ISCO technology was chosen for the depth to which the contaminated layer was located and for the ability of oxidizing substances to degrade hydrocarbons into simpler compounds that are generally not critical for the environment.

For the case under examination, two oxidizing compounds produced by Regenesis were chosen.

For the first cycle, it has been chosen the compound Regenox™, which is a compound designed to treat areas characterized by elevated concentrations of organic contaminants. The main characteristics of the product can be summarized as follows:

- It allows rapid and effective oxidation of a wide range of compounds, such as hydrocarbons (aromatic, aliphatic, polyaromatic, chlorinated);
- It consists of two parts:
 - Part A: it is the oxidizing complex consisting of a mixture of sodium percarbonate ($2\text{Na}_2\text{CO}_3 \cdot 3\text{H}_2\text{O}_2$), sodium carbonate (Na_2CO_3), sodium silicate and silica gel. The oxidizing complex appears as a fine white powder.
 - Part B: it is the activator complex consisting of a mixture of sodium silicate, silica gel and ferrous sulphate. It looks like a liquid gel. It has a rather limited longevity and acts only on the desorbed phase.

For the second cycle, it was planned to use an oxidizing product with a greater capacity to permeate the subsoil such as Sodium Persulfate ($\text{Na}_2\text{S}_2\text{O}_8$). In fact, together with a high oxidation potential, Sodium Persulfate has characteristics of high solubility and medium persistence in the subsoil. With a solubility limit equal to 40% w/w it is therefore possible to apply, for the same volume of injected solution, a greater quantity of oxidant. The reagent, suitably activated (thermally or chemically) produces the release of free radicals with high oxidation potential ($\text{SO}_4^{\cdot-}$, OH^{\cdot} , $\text{O}_2^{\cdot-}$) allowing the degradation of a broad spectrum of contaminants including organic compounds such as PAHs.



In consideration of the characteristics of the subsoil and the contaminants to be treated it is provided the use of a solution of 15% Sodium Persulfate, together with an activator based on caustic soda in 25% solution.

The criticalities found in the case in question are due to the low permeability of the soil and the recalcitrant nature of the PAHs

Reactive dosage

The theoretical dosage of RegenOx provides for an oxidant / hydrocarbon weight ratio equal to

10: 1. In this case, the theoretical dosage requires the use of 140 kg of oxidant.

In the case of injections in saturated soils, the yields for this type of intervention vary from 40% to 95% depending on the site specifics and contaminant characteristics. To ensure an adequate safety margin, it was chosen for a double dosage of oxidant, equal to a total of 300 kg. A similar quantity will be provided for the activator Part B.

According to the supplier's instructions, in order to obtain an 8% aqueous solution of oxidant, it was necessary add a quantity of water equal to about 10 liters per kilogram of oxidizer and activating agent. Therefore, for the procedure it was necessary to use a volume of water equal to approximately 3 m³.

Since it was planned to apply the oxidizer through multiple injection points, the preparation of the solution was carried out by dividing the quantities on the basis of the number of injection points.

As for the Sodium Persulfate, 400 liters of reagent were injected into the soil at each input point., resulting from the mixing of sodium persulfate at 15% and caustic soda at 25% according to the following proportions:

- 50 kg of Sodium Persulfate (Na₂S₂O₈) at 15% in 350 l of water;
- 15 kg of Caustic Soda (NaOH) at 25% in 50 l of water.

Application system

First course of treatment

The injection of the solution containing the RegenOx™ in deep soil was carried out by direct injection, with direct push machines like Geoprobe® in order to improve the oxidant distribution and homogenization in the aquifer. Due to the limited soil thickness to be treated, direct injection has been done in bottom-up mode. The injection probe, the final element of the drill rod system, is brought to the maximum depth to be treated. This probe was equipped with a nozzle opening-closing system controlled by surface, integral with the probe or disposable. This probe was equipped with a nozzle opening-closing system controlled by surface, integral with the probe or disposable. Once the desired depth is reached, the rod system was connected to the injection pump, which in turn was connected to the tank containing the oxidizing solution. At this

point the injection nozzle was opened, and then the pumping of the solution started. The pumping was continued during the rods system rise, until this reached the minimum depth of treatment. The injection system must have a volumetric counter, to allow dosing of the correct volume of solution per unit of vertical length. To guarantee a safety margin, the injection will be carried out between the depths of 3.8 m and 4.8 m from the ground level. Once the upper end of the injection interval has been reached, the same injection system will be used for the injection of a bentonite mixture during the ascent of the rod system to the surface.

The first injections cycle were performed on 30, 31 May and 1 June 2016, the second one on 11, 12 and 13 July 2016. Overall, during the two campaigns, 27 injections positioned around the polluted points of investigation LEV06, S2 and S5 were performed, where the contamination by heavy hydrocarbons C_{>12} and PAH was found. Specifically, around each point 9 injections were done according to the configuration below:

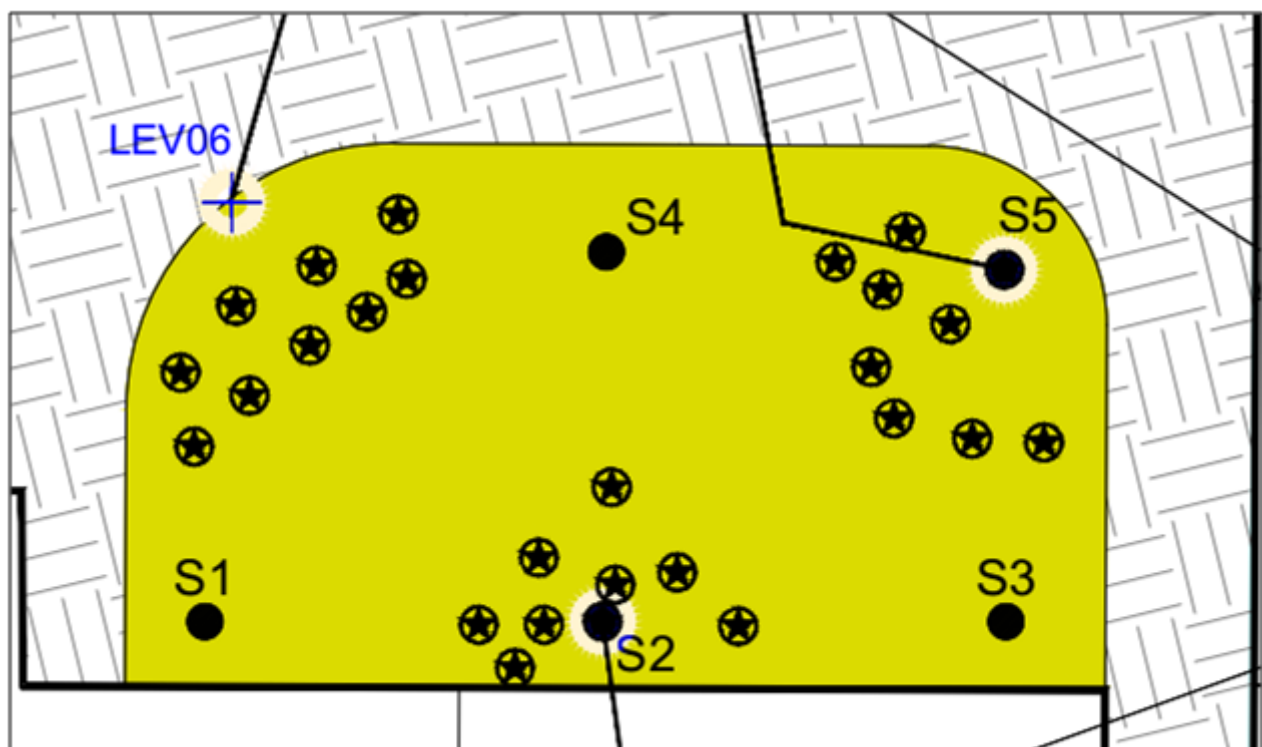

Following the injection of the oxidizing mixture, the remediation monitoring activity was carried out, which included the execution of n. 4 boreholes, with a fortnightly frequency, up to 5 m deep, for a total of 3 survey campaigns from 01/08/2016 to 29/08/2016 (T1, T2 and T3). In this way, the effect of the oxidizing mixture was monitored respect to the portion of soil subject to remediation (between 3.0 m and 5.0 m of depth from the

ground level) As shown in the following figure, the results of the performed monitoring showed a residual contamination by PAHs and heavy hydrocarbons ($C > 12$) compared to the contamination threshold concentrations (CSC) and the risk threshold concentrations (CSR) of reference provided by the Italian legislation, exclusively between 4.0 m and 5.0 m of depth, therefore in saturated soil, in the ST2 and ST4 boreholes, carried out at verification time T1 and in the ST4btris borehole carried out at verification time T3.

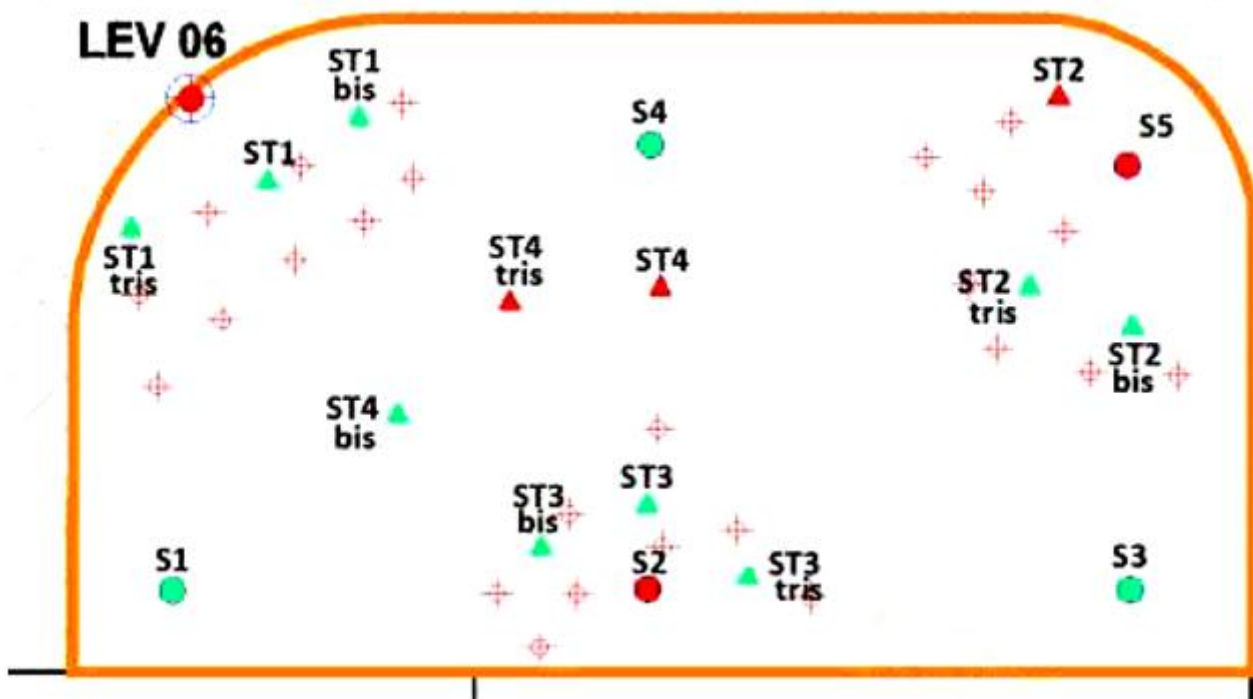

Samples to monitor remediation (ST, STbis, STtris), green means that the target concentration was reached, red means that the target concentration was not reached

In order to better define the extent of the contamination identified in the survey were ST4tris additional investigations, on 15 November 2016, were carried out:

- the perforation of 3 geognostic boreholes, up to a depth of about 5 m by the ground level (SC1, SC2 and SC3), located around the ST4tris borehole, as shown in the following figure;
- the taking of 5 soil samples corresponding to each survey (one sample representative for each meter of depth in accordance with the provisions of the current Italian law - "Protocollo operativo per la caratterizzazione dei siti ai sensi del D. Lgs.152/06 e dell'accordo di programma per la chimica di Porto Marghera – Revisione Gennaio 2008"). Altogether they were sampled and sent to the laboratory 15 samples;

- laboratory analyzes to research polycyclic aromatic hydrocarbons (PAHs) and heavy hydrocarbons C > 12.

The analytical results relating to the supplementary investigation campaign showed that the CSCs were exceeded for heavy hydrocarbons C > 12, for the SC3 and SC1 boreholes, but with concentrations lower than the target values, equal to 2200 mg/kg. For the PAHs, modest exceedances of the CSCs (corresponding to the target values) are identified in SC3 borehole only.

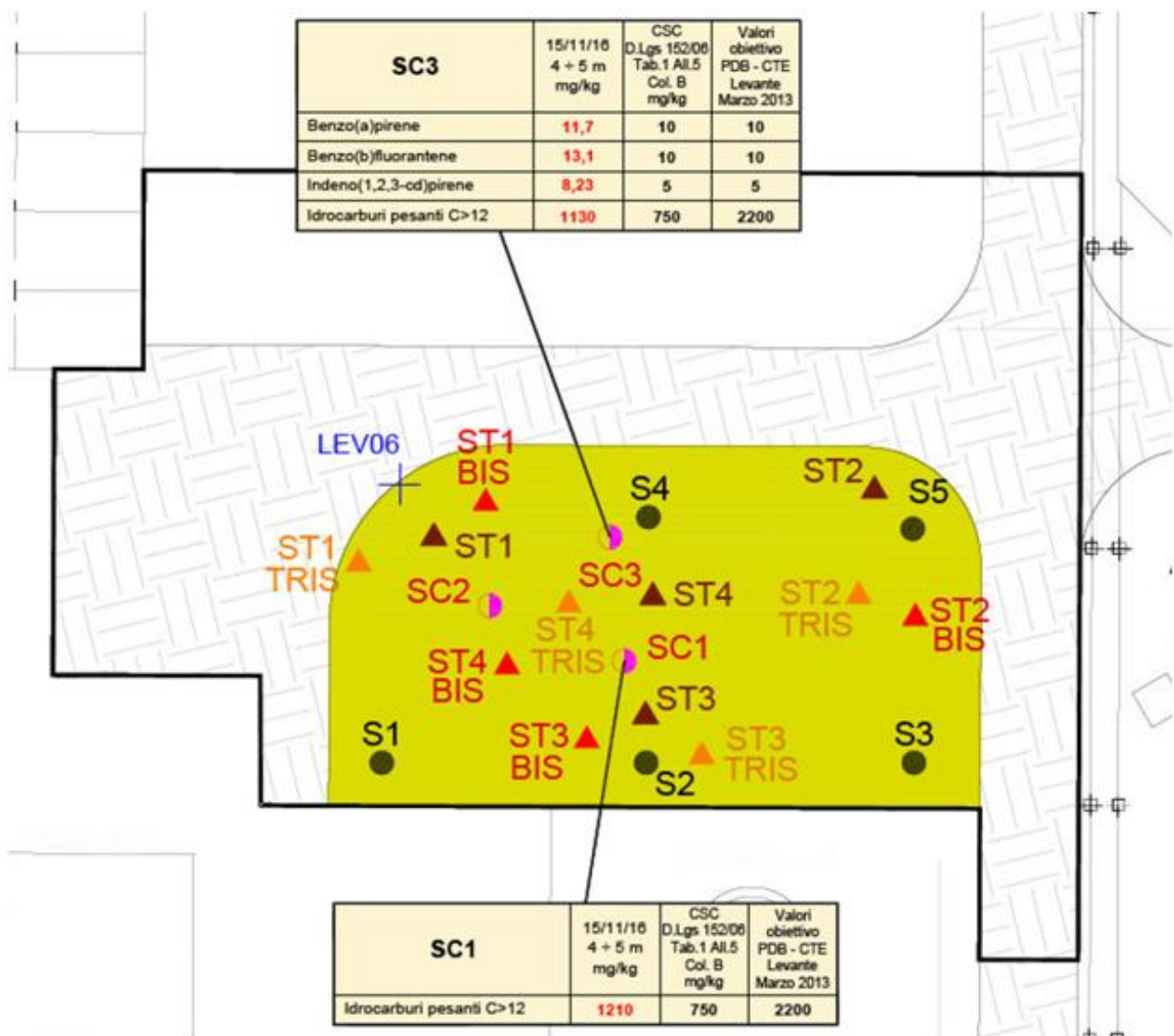

Survey of 2016

Second course of treatment

Considering the specific lithological conditions and the state of contamination found in the area in question it was chosen to use sodium persulfate ($\text{Na}_2\text{S}_2\text{O}_8$), an oxidizing product with greater ability to permeate the subsoil than the RegenOx already

employed. In addition, in the light of the need to make multiple injection; campaigns or it, it was decided to carry out the application of the oxidizing mixture through a network of injection wells specially realized. The 10 injection points, sequentially named P1 - P10 were distributed according to a regular mesh of about 2.20 m within the polygons identified by the SC3, ST4 and ST4tris probes. They were manufactured through the use of a drilling machine Atlas Copco up to 5.0 m from the ground level, to intercept the layer of soil between 4.0 and 5.0 m in depth where the overcoming of the CSCs were highlighted. At the end of the drilling activity, the boreholes were equipped with a piezometer using 3" HDPE pipes, 5.0 m long. In all piezometers the slotted portion (slot = 0.5 mm) extends for 1.5 m starting from the bottom of the hole, while the remaining 3.5 m part is blind. A drainage mantle with pre- calibrated gravel ($\varnothing = 2$ mm) from about 0.3 m above the "top" of the filtered section to the bottom of the hole was prepared in the hole/pipe interspace. To ensure a proper insulation by the penetration of surface water and to prevent the possible ascent to the surface of the oxidizing solution during the injection operations, over the drain core were paid, in sequence, a 0.5 m layer of bentonite pellets and cement mortar up to 0.3 m from ground level.

At each injection point, 400 l of reagent was injected into the soil, resulting from the mixing of Sodium Persulfate at 15% and Caustic Soda at 25% according to the following proportions:

- 50 kg of Sodium Persulfate ($\text{Na}_2\text{S}_2\text{O}_8$) at 15% in 350 l of water;
- 15 kg of Caustic Soda at 25% in 50 l of water.

The two substances, solid powder the sodium persulfate and liquid the caustic soda, were previously mixed with water in separate tanks in order to minimize the probability of triggering of exothermic reactions dangerous for operators and, only subsequently, mixed together in a common tank. The mixing of the substances was carried out by means of a manual electric mixer with stainless steel stirrers and was continued until their complete or homogenization.

The injection took place by means of a dedicated automatic unit consisting of a piston motor pump and a sealing cap screwed to the wellhead. The injection pressure was constantly monitored and kept less than 2 bar to prevent the flowing back of the substance in neighbouring injection points. Respecting this modality, the only visible effect of the injections was an increase in the local piezometric level of about 0.5 m. In May 2017, 10 injection points were distributed, according to a regular mesh inside of the polygons identified surveys SC3, ST4 and ST4tris as indicated in the following figure.

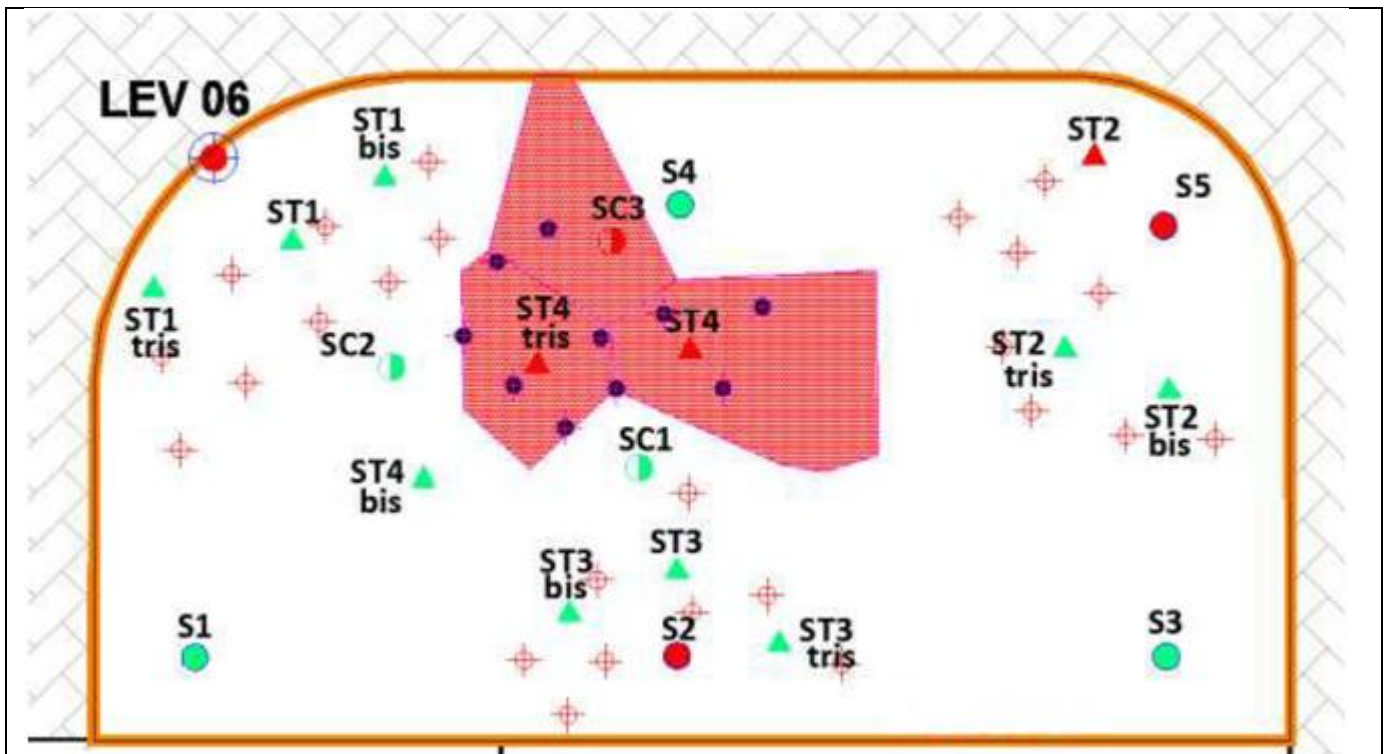

New injection points

Once the new network of injection points had been developed, the first ISCO intervention took place on the 10 injection points on 29, 30 and 31 May 2017 and the second intervention took place on 3 and 4 July 2017. Subsequently, on August 9, 2017 a land monitoring campaign was carried out that showed the presence of PAHs and heavy hydrocarbons ($C > 12$) in concentrations superior to remediation targets in the range of a depth of only between 4.0 m and 5.0 m in depth only, corresponding to saturated soils, and for the monitoring points SMI_1 and SMI_3 only. Instead, at the same depth, the SMI_2 sample presented concentrations of heavy hydrocarbons in excess respect to the CSC reference but lower than the CSR reference. Finally all the samples from the survey SMI_4 showed concentrations of the sought parameters lower than the reference CSC.

SMI_3	09/08/17 4 + 5 m mg/kg	CSC D.Lgs. 152/06 Tab. 1 All.5 Col. B mg/kg	Valori obiettivo PCB - CTE Levante Mazzo 2013
Benzo(a)antracene	25,3	10	10
Benzo(a)pirene	21,3	10	10
Benzo(b)fluorantene	17,8	10	10
Benzo(g,h,i)perilene	12,0	10	10
Indeno(1,2,3-cd)pirene	11,7	5	5
∑ idrocarburi polic. aromatici	167	100	-
Idrocarburi pesanti C>12	4050	750	2200

SMI_2	09/08/17 4 + 5 m mg/kg	CSC D.Lgs. 152/06 Tab. 1 All.5 Col. B mg/kg	Valori obiettivo PCB - CTE Levante Mazzo 2013
Idrocarburi pesanti C>12	1740	750	2200



SMI_1	09/08/17 4 + 5 m mg/kg	CSC D.Lgs. 152/06 Tab. 1 All.5 Col. B mg/kg	Valori obiettivo PCB - CTE Levante Mazzo 2013
Benzo(a)antracene	26,7	10	10
Benzo(a)pirene	27,2	10	10
Benzo(b)fluorantene	25,4	10	10
Benzo(k)fluorantene	13,0	10	10
Benzo(g,h,i)perilene	16,5	10	10
Indeno(1,2,3-cd)pirene	13,8	5	5
∑ idrocarburi polic. aromatici	203	100	-
Idrocarburi pesanti C>12	7120	750	2200

Point with concentration higher than the remediation target

From the outcomes of the executed campaigns it should be noted that the oxidation intervention resulted only partially effective in the treatment of contamination from heavy hydrocarbons and IPA in the saturated soils, between 4.0 m and 5.0 m in depth. This occurred even if an increase in the reagent dosage and more soluble mixtures were adopted. The verification investigations have in fact highlighted a residual contamination in the soils characterized by the presence of high concentrations of heavy hydrocarbons and PAHs in a localized portion of the subsoil around the monitoring points SMI_1 and SMI_3.

In light of the results achieved, it was necessary to evaluate the state of affairs of the area by means of a testing activity aimed at defining the portions of land that have

achieved the objectives and those that still present residual concentrations, higher than those foreseen in the authorized project.
 Finally, the persistence of concentrations exceeding the target value was resolved with a risk analysis.

5.2 Additives

In the case of oxidant complex RegenOx™, consisting of a mixture of percarbonate of sodium and an activating complex constituted by a mixture of sodium silicate, silica gel and ferrous sulfate. It appears as a liquid gel.
 Instead, in the case of Sodium Persulfate ($\text{Na}_2\text{S}_2\text{O}_8$), Caustic Soda (NaOH) has been added.

5.3 Injection type

The methods of injection of the oxidant are described in section 4.1
 The figures below describe the different phases of treatment.

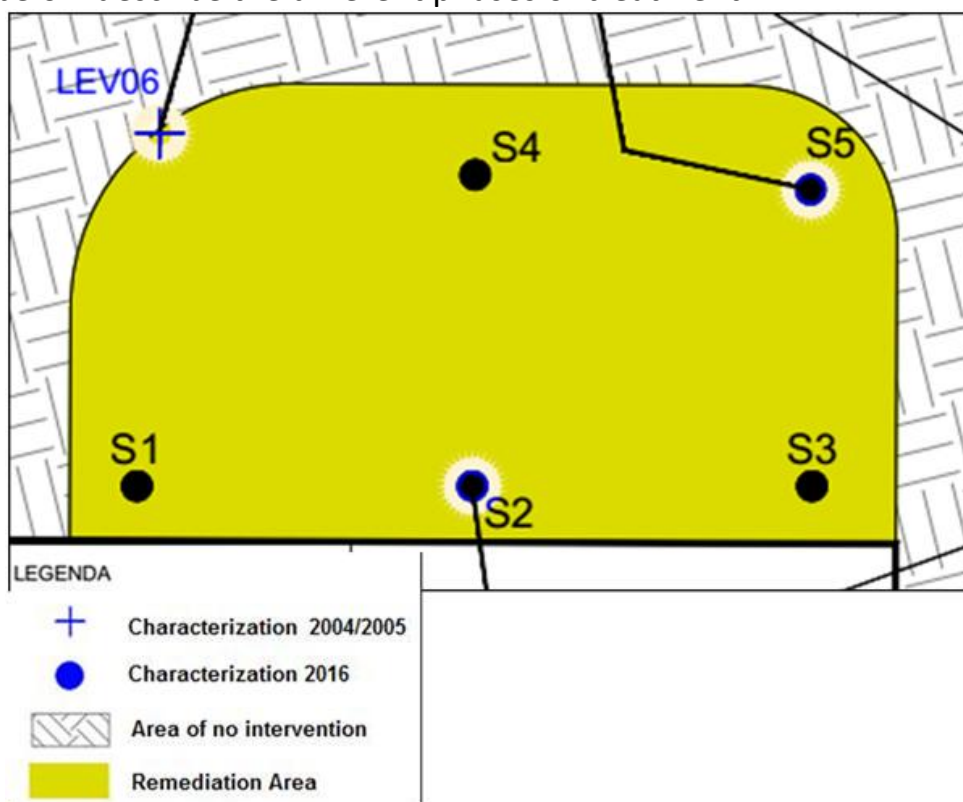

Survey contaminated by LEV06 characterization and integrative surveys to limit the intervention area

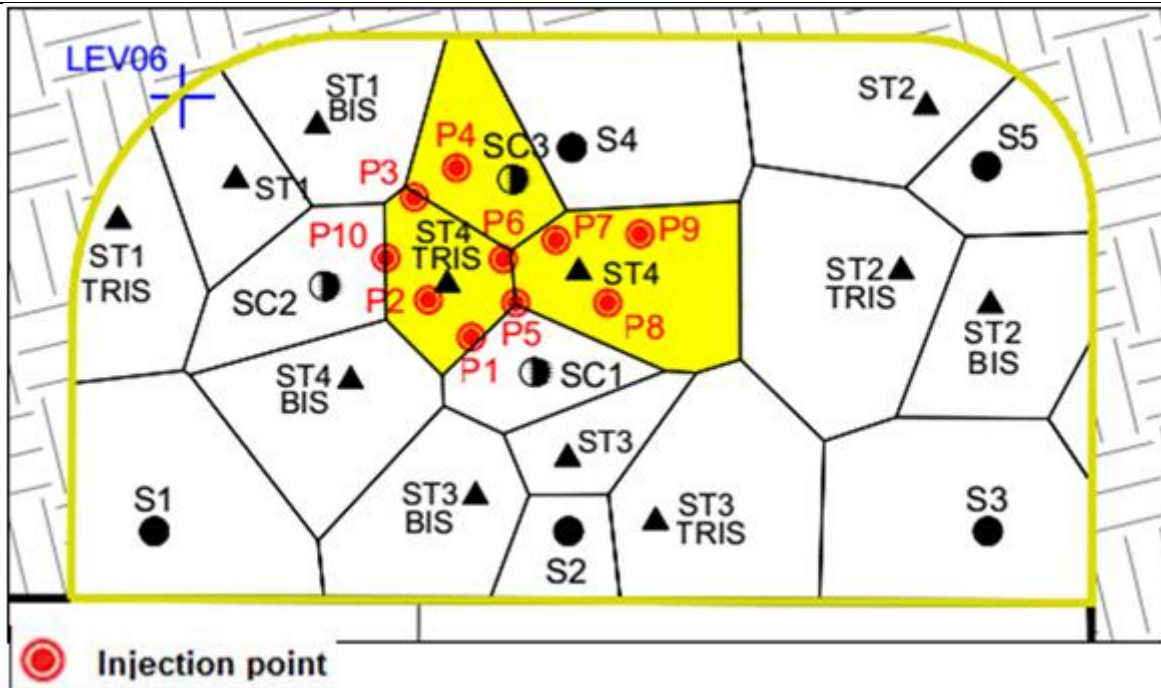

Second cycle of treatment with sodium persulfate

- Information on the injection layer is given in paragraph 2.3
- Information about the number of injection campaigns (how many campaigns, timing, dosages) and the dosage of the ISCO agent are reported in section 4.1
- No injection enhancement system was used.

The following table shows a summary of the activities performed

Summary of the activities performed		
Activity	Task	Date
January 2016 - November 2016		
Setting up of the construction site area	1. Setting up of the construction site area 2. Laying of the fences	26/01/2016
Additional characterization of the LEV06 parcel of the area	1. Drilling activity 2. Supervision of soil sampling activities 3. Laboratory analysis	26 and 27/01/2016
Injection of oxidant (RegenOx)	1. Preparation of the oxidizing mixture 2. Direct push into the soil	First stage 30+31/05/2016 and 01/06/2016 Second stage 11+13/07/2016



Monitoring of the remediation progress	<ol style="list-style-type: none"> 1. Drilling activity 2. Supervision of soil sampling activities 3. Laboratory analysis 	First investigation campaign 01/08/2016 Second investigation campaign 12/08/2016 Third investigation campaign 29/08/2016
Additional characterization	<ol style="list-style-type: none"> 1. Drilling activity 2. Supervision of soil sampling activities 3. Laboratory analysis 	
May 2017 – August 2017		
Location of injection points and construction of piezometers	<ol style="list-style-type: none"> 1. Identification of underground utilities 2. Location of injection points 3. Execution of drilling 4. Installation of piezometers 5. Piezometer development 	22+23+24/05/2017 29/05/2017
Injection of oxidant (Sodium Persulfate)	<ol style="list-style-type: none"> 1. Preparation of the oxidizing mixture 2. Injection activity 	First stage 29+31/05/2017 Second stage 03+04/07/2017
Monitoring of the remediation progress	<ol style="list-style-type: none"> 1. Drilling activity 2. Supervision of soil sampling activities 3. Laboratory analysis 	First investigation campaign 09/08/2017



5.4 Radius of influence

Additional surveys were planned to precisely limit the extent of the contamination of the area, within the intervention area defined on the basis of the Thiessen polygon. The boreholes were arranged with a regular mesh (15 m x 15 m) around point LEV06. The perforations were pushed up to the “Caranto” (local name of a Pleistocene paleosol consisting of an extremely compact, silty-sandy clay), the top of which is located in this area at a depth of approximately 4.5 m from the ground level. One sample per meter of thickness crossed was taken, to be analyzed in the laboratory.

Based on the analytical results, the area to be treated was defined and the quantities of contaminants present were estimated.

The range of influence has not been calculated. An estimate It was made from literature data as a function of low permeability of the soil and the test was carried out on a pilot-scale according to the supplementary characterization performed as in the first figure of the previous paragraph 4.3, verifying the effectiveness of the treatment as per the following paragraph

5.5 Process and performance monitoring

To assess the actual degradation of the contaminant in the first injection cycle and for possibly define some corrective manoeuvres, samples of soils within the injection area were carried out fortnightly, during the 45 days following the injection.

In the second treatment cycle, the first check of the remediation progress was performed approximately 30 days after the last injection.



6. Post treatment and/or Long Term Monitoring

6.1 Post treatment and/or Long Term Monitoring

In the case study described, it was not necessary to provide for long-term monitoring due to the low mobility of the contaminants.

Glossary of Terms

Term (alphabetical order)	Definition
CSC	Contamination threshold concentrations
CSR	Risk threshold concentrations
NAPL	Non-Aqueous Phase Liquids
SIN	Site of National Interest
VCM	Vinyl Chloride Monomer