

LESSONS LEARNT
from industrial accidents

IMPEL Seminar
Aix-en-Provence, 16 and 17 November 2011

Table of contents

Fire outbreak in a wood recycling plant	Page
Saint-Cyprien (Loire) – France	
22 August 2008	
Break in a liquid hydrocarbon pipeline	page
Plaine de la Crau (Bouches-du-Rhône) - France	
7 August 2009	
Massive alumina red sludge release after the failure of a containment dam.....	Page
Kolontár - Hongrie	
4 October 2010	
Explosion of a superheater within a steam-cracking unit	Page
Saint-Avold (Moselle) - France	
15 July 2009	
Derailment of LPG tank-wagons followed by a UVCE explosion and	Page
an intense fire	
Viareggio - Italy	
30 June 2009	
Explosion of a sulphuric acid tank.....	Page
Gonfreville l'Orcher (Seine Maritime) - France	
4 August 2009	
Explosion in a chlor-alkali plant due to a voltage dip.....	Page
Ibbenbüren - Germany	
23 July 2009	
Rupture of a pipeline within an underground hydrocarbon storage facility.....	Page
in saline cavities	
Manosque (Alpes-de-Haute-Provence) - France	
1st may 2010	
Hazardous substance release following inadequate HAZOP studies	Page
Heilbronn - Germany	
21 September 2010	
Fertiliser decomposition in a dryer	Page
Ribécourt-Dreslincourt (Oise) - France	
8 February 2010	
Explosion in a carboxyméthylcellulose production plant.....	Page
(cellulose gum)	
Nijmegen (Gelderland) – The Netherlands	
11 July 2009	
Bursting of a high-pressure steam pipe	Page
Grand Quevilly (Seine Maritime) – France	
28 June 2010	
Rupture of an oxygen pipeline	Page
Richemont (Moselle) - France	
13 June 2010	

- ANNEXES -

Analogies	Page
European scale of industrial accidents.....	Page
Glossary and acronyms	Page

Fire outbreak in a wood recycling plant

22 August 2008

Saint-Cyprien (Loire)

France

Fire
 Atmospheric releases
 PCB / dioxins
 Waste
 Soil pollution
 Health impact

THE FACILITIES INVOLVED

This accident took place at an industrial site that had been devoted to copper and lead recovery since the 1970's. Authorisation was granted in July 1981 to extend operations to include metal recovery by means of burning (using combustion furnaces) and destruction of electrical transformers. In July 1989, the site operator added radiator milling to its scope of activities.

Findings issued by the classified facilities inspectorate on the state of pollution at the site led to commissioning, by a 1997 Prefectural order, a comprehensive soil analysis.

In June 2006, the site was taken over by a new operator and an official permit was awarded in July of the same year for the activity of milling and storing recycled timber (headings 2260 / milling and 1530 / storage, under the nomenclature of classified facilities).

The site's environment :

The site was set in a rural locale. It was bordered on the south by a gas depot and sand blasting operation. To the north and east were agricultural fields for the most part and the west side contained derelict land. The nearest dwellings were 300 m away.

The water table was flowing relatively close to the surface in a north-easterly direction. Some 20 pools used as cattle watering holes were found in the sector, in addition to the MELBIEF and MALTAVERNE streams and Veauchette ponds.

The LOIRE River ran just 1 km east of the site.

THE ACCIDENT, ITS CHRONOLOGY, EFFECTS AND CONSEQUENCES

The accident :

On 22 August 2008, a fire broke out around 4 am at a wood storage zone (containing pallets), spanning 2,000 m² of land area with heights in some spots reaching 10 m. Emergency response units quickly arrived at the scene with over 60 fire-fighters deployed. An impressive column of smoke drifted towards the agricultural areas.



SDIS 42

Several days were needed to bring the fire under control, as winds fanned the flames. Also, fire-fighters were forced to change strategy at the end of August, following a pollution incident at the Veauchette ponds due to the fire extinction water. Fire sources had to be isolated from the rest of the stockpile, which led to mixing wood with earth.



The wood stockpile was allowed to gradually burn through the beginning of December 2008. Heavy rains in November 2008 gave rise to many instances of flooding in the Loire and Haute-Loire Departments: this had the effect of lowering the wood combustion rate.

From 15 September to 17 October 2008, an organisation specialised in air quality monitoring was commissioned to conduct air measurements both onsite and offsite. Several pollutants were monitored (e.g. VOC, PAH, SO₂, NO₂...), with emphasis on dioxins and PCBs. Results of this measurement campaign were released on 18 November 2008.

Subsequent to the observation of major atmospheric emissions of both dioxins and polychlorobiphenyls (PCBs) onsite, the local Veterinary Department extracted a series of milk samples on 26 November 2008 from a neighbouring farm. Contamination was shown to be present, in light of results exceeding the regulatory threshold values for marketing foodstuffs (European regulation 1881/2006/EC); the farm had to be cordoned off.

What exactly are PCBs?

Also referred to as "askarel", PCBs are synthetic molecules:

- with a similar composition to that of dioxins (especially for the PCB-DL, with a toxic action mechanism similar to that of dioxins and furans)
- previously used in industry for their insulating properties (electrical transformers, condensers, lubricating oils, inks, etc.)
- prohibited on the market, since 1987

Substance classified as "likely carcinogen".
Hepatitis and dermatology-related problems have been known to occur in populations experiencing heavy exposure.

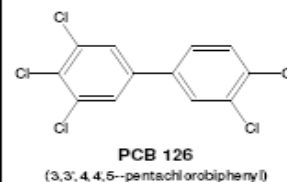

What are the critical challenges for the environment?

A **residual background** of dioxins and PCBs within the environment.

PCBs **only decompose very slightly** and remain difficult to destroy. Present in both soil and sediment, these contaminants continue to accumulate throughout the food chains in animal fat.

90% of total exposure to PCBs is accounted for today through food sources (very little through air or water).

Regulations issued regarding dioxin and PCB contents in food:

- Regulation EC No. 1881/2006
- Recommendation No. 144/06/COL, dated 11 May 2006

Maximum contents of dioxins, furans and dioxin-like PCBs in foods (WHO-PCDD/F-PCB-TEQ):

- Meats and fat BV/OV: **4.5 pg/g fat**
- Milk and dairy products: **6 pg/g fat**
- Eggs and egg products: **6 pg/g fat**
- Fish and fishing products: **8 pg/g flesh**

Unit of measurement: 1 picogram (1 pg) = 0.000 000 000 001 g (1 picogram/g = 1 nanogram/kg)

Sources: DDPP 42 Protection Authority, Loire Department Prefecture Website

This oversight was then gradually extended to the milk and fat produced by farm cattle over a zone encompassing 42 towns and villages. In all, 914 farms underwent examination within the zone. A series of sanitation protocols were adopted, and a total of 2,353 animals wound up being slaughtered (cows, sheep, pigs and horses).

Historical overview of the accident :

2008

22 August : Fire outbreak at the company's premises (former site devoted to transformer destruction); in-depth visit by the classified facilities inspection authorities with the Regional Office for Environment, Planning and Housing (DREAL).

28 August : Detailed inspection of the site conducted by DREAL staff.

29 August : Emergency shutdown on the grounds of an ICPE (environmental protection) order calling for water and soil analyses under windy conditions; reported pollution sighting at the Veauchette ponds.

3 September : Announced suspension of all site activity.

During September : New strategy unveiled to extinguish the fire by limiting pollution entering the Veauchette ponds, subsequent to the use of large quantities of water.

15 September : Intervention of an independent organisation to conduct onsite air measurements.

18 November : Publication of the air analysis results.

26 November : Initial sampling at a farm site (results known on 9 December 2008).

During December : Complete extinction of the fire.

Based on a proposal submitted by DREAL staff and after the inspection pursuant to the ICPE order:

8 December : Prefectural order mandating the removal of all waste and polluted soil, along with a study focusing on compatibility of the local environment with potential land uses and activities.

24 December : Issuance of a Prefectural decree ordering sampling in groundwater and surface water sources, soils, plant life, as well as stripping of the affected site and its network of ditches.

2009

January : Investigations performed at several farms within a 1-km radius.

February and March : Continued investigations over a zone lying between 1 and 2 km.

April and May : Subsequent to modelling work, extension of the investigation zone to the 2-5 km range.

25 May to 3 July : Sampling campaign targeting animal products covering 40 towns and villages.

25 June : First slaughter of contaminated animals.

29 June : Release of a draft Prefectural order mandating land use modifications, with a specialised public-sector body assigned to secure the site (through waste disposal).

July : Removal of wastes (wood and cleaning sludge) from the burned parcel.

5 August : Inspection by DREAL staff to sign off on the completion of restoration works.

21 October : Based on the DREAL proposal, Prefectural notification order relative to : groundwater monitoring ; execution of a study on the compatibility of the local environment with land uses ; and stripping of the burned parcel until reaching a residual PCB content of 1 mg/kg, with the removal of polluted earth through appropriate channels.

2010

18 January : Prefectural notification for the definitive shutdown of activities at installations dedicated to the recovery of metals that had not been extracted for at least 3 years.

4 February : Order relative to a deposit amount of €4,000 for the groundwater monitoring campaign (conducted during summer 2009), subsequent to the October 2009 official notification.

23 February : The recycling company enters into bankruptcy proceedings.

24 February : Site visit by the Classified Facilities Inspectorate, none of the follow-up works mandated in the October 2009 order had been completed.

16 April : Prefectural order relative to a deposited sum of €1,920,000 for noncompliance with the October 2009 order.

24 June : last slaughter of animals.

Consequences of this accident :

This accident resulted in multiple consequences :

Hazardous substances released :

Air samples collected near the site during the fire revealed significant concentrations of dioxins, furans and PCBs.

Sampling carried out following the accident yielded atypical PCB values in soils as well as in surface water and groundwater, which correlated with the previous activities performed at the same site (involving electrical transformers).

Environmental and health-related consequences :

The tremendous quantities of fire extinction water used on the blaze was responsible for a high rate of mortality among fish population in the Veauchette ponds at the end of August 2008.

During the first quarter of 2009, a campaign was launched to analyse farm products, initially targeting all farms lying within a 1-km radius around the burned parcel. Results from these investigations did not match findings of the analyses on milk and fat at 14 of the 19 farms tested.

Over time, investigations were extended to a radius of 2 kilometres (March 2009), then out to 5 km (April 2009).

In July 2009, a specialised body noted in a report that beyond the 2-km radius, it becomes difficult to determine the precise origin of soil contamination, meaning that beyond a 2-km distance, no scientific justification can be made for correlating animal contamination with the fire.

On the other hand, the dioxin and PCB results obtained on milk and fat samples stemming from contaminated animals indicate similarities for a large proportion of samples (particularly the PCB/dioxin ratio found in fats).

Data interpreted by this independent body apparently showed the fire's major impact, covering a 1-km radius with effects decreasing steadily out to 2 km.

On 25 May 2009, the monitoring zone was expanded, by means of Prefectural order, to include 40 towns and villages, and then eventually to 42 municipalities in August 2009.

Economic consequences :

a) Animal slaughter :

The cost of investigative work (including analyses), the destruction steps applicable to contaminated products and animals, plus the compensation sums awarded was collectively valued at nearly €4.5 million (end of January 2011).



RR

b) Removal of wastes from the site :

A deposit amount of €100,000 was entrusted to the site operator as part of the June 2009 Prefectural order to dispose of all remaining wastes (wood and cleaning sludge) on the burned parcel.

c) Pollution clean-up of the site :

This clean-up work consisted of :

- stripping the parcel over a depth varying from 30 to 150 cm, in recognition of the pollution gradient, amounting to a total volume of 7,600 m³ of earth to be removed (or 12,000 tonnes);
- disposing of all soils whose PCB contents lie below 50 mg/kg at a Class 2 dumpsite, along with loading and transporting of these soils, which required 600 lorry rotations at a specially designated site in the Allier Department (central France) or at a dumpsite for inert wastes, depending on the contents involved;
- treating the soils at a specialised facility whenever PCB contents exceeded 50 mg/kg, making these soils ineligible for landfill disposal. The quantity of soils undergoing specific treatment was supposed to be limited to just the most heavily polluted zones and represent a total of 60 tonnes;
- restoring the site to its prior condition upon completion of these clean-up works (replacement with good quality soil and necessary earthworks);
- conducting a study to assess compatibility of the local environment with land uses (sampling and analyses in various settings, inventory of water resources, evaluation of the site's hydrology and hydrogeology), and given these studies' specific scope the set of analyses left to be performed in the investigated zone.

The monetary amount eventually entrusted to the operator to execute these various works and/or studies was set at €1.92 million, as stipulated in the 16 April 2010 Prefectural order.

The European scale of industrial accidents :

By applying the rating rules applicable to the 18 parameters of the scale officially adopted in February 1994 by the Member States' Competent Authority Committee for implementing the 'SEVESO' directive on handling hazardous substances, and in light of information available, this accident can be characterised by the four following indices:

Dangerous materials released		<input checked="" type="checkbox"/>	<input type="checkbox"/>	<input type="checkbox"/>	<input type="checkbox"/>	<input type="checkbox"/>	<input type="checkbox"/>
Human and social consequences		<input type="checkbox"/>	<input type="checkbox"/>	<input type="checkbox"/>	<input type="checkbox"/>	<input type="checkbox"/>	<input type="checkbox"/>
Environmental consequences		<input checked="" type="checkbox"/>	<input checked="" type="checkbox"/>	<input checked="" type="checkbox"/>	<input checked="" type="checkbox"/>	<input checked="" type="checkbox"/>	<input checked="" type="checkbox"/>
Economic consequences		<input checked="" type="checkbox"/>	<input checked="" type="checkbox"/>	<input checked="" type="checkbox"/>	<input checked="" type="checkbox"/>	<input checked="" type="checkbox"/>	<input type="checkbox"/>

The parameters composing these indices and their corresponding rating protocol are available from the following Website: <http://www.aria.developpement-durable.gouv.fr>

The "Dangerous materials released" index was assigned a "1" as a default rating, due to the smoke release containing PCB that spread into the environment.

The "Environmental consequences" index was scored a "6", as the polluted land area spanned a 2-km radius centred at the point of fire outbreak; this area amounts to roughly 1,250 hectares (parameter 'Environment 13').

The "Economic consequences" index was assigned a "5" since sanitation operations were estimated at a cost of nearly €4.5 million ('Parameter €17').

The "Human and social consequences" index was left blank due to a lack of data on this indicator.

THE ORIGIN, CAUSES AND CIRCUMSTANCES SURROUNDING THIS ACCIDENT

The fire :

The blaze was discovered around 4 am by the site caretaker, whose house was located just opposite the wood storage zone. Local fire-fighters were notified immediately thereafter.

The source of the fire however has remained unconfirmed. It appeared that the fire broke out on a crushing machine. During the follow-up investigation, the classified facilities inspection authorities noted that according to employee accounts, the crusher was turned off around 5 pm the previous day. Plant workers had not noticed anything in particular that could have triggered combustion of the wood stockpile.

The local gendarmerie at Andrézieux-Bouthéon carried out an investigation to determine the causes of this accident.

PCB pollution :

Several elements are undoubtedly at the origin of this pollution event :

- Various operators have successively set up operations at the Saint Cyprien site, and their activities would have possibly included unloading, storing and draining materials at the exact spot (parcel no. 132) where the fire broke out, consuming electrical transformers containing askarel;
- The pollution clean-up work imposed in 2001 upon a former operator was most likely left incomplete and moreover only applied to parcels adjacent to no. 132, since this parcel was not selected for the simplified risk study conducted by the former operator;
- The location of the wood milling unit on parcel no. 132, as opposed to one of the neighbouring parcels, as stipulated in the authorisation documents.

ACTIONS TAKEN

Administrative impacts :

During its site visit on 22 August 2008, the classified facilities inspectorate noted that the wood could have been contaminated or treated using chemical products. The volume of wood stored onsite also exceeded the authorised limit according to the corresponding activity code. A Prefectural emergency decree, issued on 29 August 2008, prescribed analyses of both the site's groundwater and soils in adjacent agricultural zones.

The Loire Departmental Prefect also mandated the following, by means of Prefectural orders issued on 29 August, 3 September, 8 December and 24 December 2008 :

- investigations on soils, groundwater and surface water resources in order to measure the consequences of this fire on the environment ;
- cleaning of the contaminated zones ;
- suspension of all site activity ;
- clarification of the company's administrative situation ;
- deposit of the amount earmarked for waste disposal ;
- role of a specialised organisation in the waste disposal process ;
- deposit of the amount earmarked for pollution clean-up works.

These decrees, and particularly the administrative sanctions that followed (with the issuance of Prefectural orders serving as official notifications on 29 May and 12 June 2009, plus the allocated sum announced in the 23 June 2009 order), set the stage for a specialised body to intervene in the disposal of wastes remaining on parcel no. 132 in July 2009 (order adopted on 29 June 2009).

To identify the environmental contamination and its source, the inspectorate commissioned an expert to characterise the state of the various media occupying this sector. An initial model was developed by taking into account the very active phase of the fire over a several-day period beginning on 22 August 2008.

This study confirmed a large-scale impact in terms of dioxins and furans on the burned parcel, in addition to pointing out a substantial impact for parcels lying close to the fire outbreak and strong residual background for those located within a wider perimeter (on the order of a few kilometres).

The classified facilities inspectorate has been heavily solicited after the accident : a dozen or so inspections by DREAL staff were carried out over the period from August 2008 to April 2011. Dozen of work meetings were also necessary.

In addition, the Veterinarian Services were also strongly engaged :

- numerous meetings for crisis management ;
- accommodation and supervision of the crisis unit ;
- a hundred or so interviews with farmers whose animals were contaminated ;
- a thousand or so tests performed, as part of sanitation protocols.

Health-related aspects :

An initial appraisal of 10 samples of milk and fat conducted within a zone situated more than 5 km from the site revealed that samples from the 10 dairy farms displayed PCB contents compliant with standards, yet 7 of the 10 breeding farms produced noncompliant sample results.

A series of administrative decrees were adopted in order to limit the consumption of products from local farmyards or cattle, in addition to prohibiting grazing on local pastureland.

Moreover, a number of orders were gradually enacted during 2009 for the purpose of prohibiting the consumption of local products or restricting their use, as presented below in chronological order:

- 30 January 2009, isolating products intended for human consumption that had been potentially contaminated by dioxin-like PCBs;

- 17 April 2009, prohibiting the consumption of all meat products from farmyards and cattle raised within a 2-km radius around the site;
- 25 May 2009, prescribing monitoring measures over the zone potentially contaminated by dioxin-like PCBs;
- 28 May 2009, prohibiting the feeding of cattle with water directly drawn from the the MALTAVERNE stream, over its stretch downstream of the accident site and until reaching the confluence with the LOIRE River;
- 2 June 2009, isolating products intended for human consumption that had been potentially contaminated by dioxin-like PCBs (from game hunting);
- 25 June 2009, prohibiting any kind of farming practice over a 200-m strip around the accident site;
- 11 September 2009, prohibiting the consumption of game, over a zone extending 5 km;
- 8 December 2009, prescribing a set of measures relative to the grazing and watering conditions for animals on farms within the 2-km zone, encompassing the villages of Saint-Cyprien, Sury-le-Comtal, Craintilleux, Veauchette, Andrézieux-Bouthéon and Bonson.

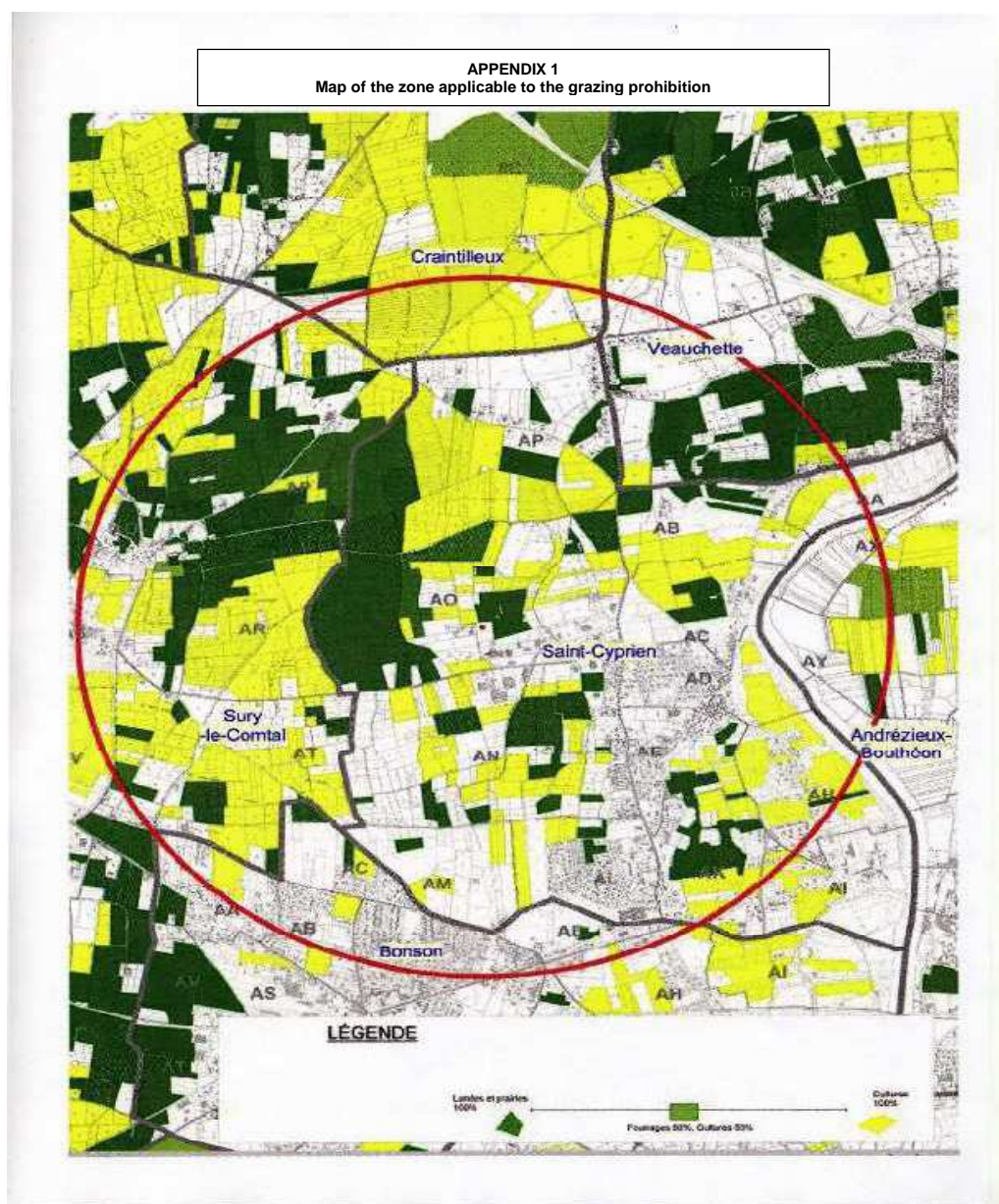

Copyright

Between August 2008 and October 2011, 2,353 animals were slaughtered (mainly cows). The animal corpses generated bone meal that was treated by a local cement plant as well as fats capable of containing PCBs, which were subsequently shipped to a treatment plant in Belgium. 186,937 litres of raw milk were discarded. Once skimmed, the milk was poured out, and the cream was treated at a specialised centre. 320 tonnes of fodder, along with nearly 700 kg of products intended for butcher shops, were incinerated.

Ultimately, a total of 960 animals were slaughtered within the 1-km radius zone, 186 within the second kilometre, 591 between 2 and 5 kilometres out, and another 518 in the monitoring zone beyond 5 km from the original site.

The French Agency for Food Safety (AFSSA) was solicited on several occasions to provide input on measures to adopt that would ensure limiting the risks of food chain contamination. The Agency issued its opinion on 7 July, 2009 relative to soil contamination from dioxins and dioxin-like PCBs, as well as to the potential use of these soils in connection with eventual repercussions on the sanitary quality of certain agricultural products. The Agency released an additional opinion on 20 April 2010 regarding pig farming activities in the area.

An opinion dated 1st June 2010 was also issued relative to an accidental contamination of foodstuffs by dioxins and PCBs at Saint-Cyprien (Loire Department).

Monitoring plan :

A monitoring plan was implemented following an instruction of the Directorate General of Food (DGAL) on the central area of 2 km. It revealed two new positive cases in 2010/2011, which resulted in a new slaughter of about 70 cattle. This monitoring plan was renewed in 2011.

Crisis communication measures :

From the outset, managing the consequences from this fire gave rise to multiple exchanges, for starters between the Mayor of Saint-Cyprien, a subcontractor specialised in atmospheric pollution, the Deputy Prefect of Montbrison, local Fire and Emergency Services (SDIS 42), local gendarmerie, Departmental Health and Social Affairs Office (DDASS), Departmental Public Works and Agriculture Agency (DDEA) and, lastly, the Regional Office for Industry, Research and the Environment (DRIRE, subsequently became DREAL). This first set of meetings (held on 11 September, 15 October and 18 November 2008) were intended to provide regular updates on the initial consequences identified from pollution of: air, surface and groundwater resources, and soils.

During the meeting of 18 November 2008, the subcontracted organisation presented the results of air measurement analyses on PCBs and dioxins. These follow-up meetings were extended to include Veterinarian Services, Civilian Population Protection Services and the agricultural profession, as represented by the Chamber of Agriculture and National Farmers' Trade Union Federation (FNSEA), and then reached out to the Loire-Forez Metropolitan Council (CALF) and the Loire Departmental Council. The Loire Prefecture organised a total of 18 meetings between December 2008 and October 2010.

Moreover, the Prefecture and/or State agencies communicated via the press, during television interviews and with local newspapers, as well as through the Prefecture's Website, which featured a page dedicated to the PCB crisis. On this same Website, the main set of reports, studies, analysis results and orders restricting uses were made available for public consultation. The area's mayors and farming profession relayed information to the local level.

From a health protection standpoint, communication tools, established for the most part by the Departmental Health and Social Services Office, were disseminated to the various municipalities, village physicians in areas concerned by atmospheric fallout, in addition to their availability on the Prefecture's Website. These documents contained recommendations for limiting PCB ingestion.

Treatment of fire-related wastes :

Crushed wood stockpiles and sludge stemming from ground clean-up operations constituted the bulk of onsite wastes. Transport of these wastes to specialised treatment facilities took place between 10 and 31 July 2009. Afterwards, a dedicated basin was created for cleaning vehicle wheels. In addition to its function of preventing pollution from spreading beyond the plant boundary, this basin was intended to reduce the incidences of dirtying the public street system.

Airborne dust represented one of the major risks for personnel on this jobsite. To prevent dust from becoming airborne during lorry loading with a power shovel, hydraulic sprinkling was designed into the process, with a 10-m³ tank installed for this very purpose.

In all, 70 lorry rotations were necessary to dispose of the waste stored onsite (1,678 tonnes of wood and 8.14 tonnes of cleaning sludge). An additional transport operation was devoted to polluted individual protection gear as well as the water and cover used on the cleaning basin.

Fate of the recycling company :

On 23 February 2010, the recycling company filed for bankruptcy with the Saint-Etienne Commercial Court. In a correspondence dated 26 March 2010, the court-appointed liquidator informed the appropriate agency that the ongoing procedure against the bankrupt company would not yield any financial return.

The company was actually bought on 12 May 2009 by another firm ; however, the business sales contract excluded the Saint Cyprien site from the buyout arrangement.

Treatment of polluted soils :

Some 7,600 m³ of soil had to be removed, i.e. the equivalent of 12,000 tonnes. Given the cost of pollution clean-up work reaching approx. €2 million and due to the fact that the Saint Cyprien site was now considered devoid of management,

only the intervention of a public-sector body could ensure appropriate safety measures and effective site management over the long run.

On 10 December 2010, the Ministry of Sustainable Development gives its consent to the Loire Departemental Prefect for a public body to be commissioned to :

- conduct a hydrogeological and hydrological study of the sector of the site ;
- define more precisely the areas in which the concentration thresholds proposed by the AFSSA are exceeded ;
- to propose a management plan of the site pollution and of all parcels impacted and presenting a health risk.

In a second phase, remediation work will be conducted.

LESSONS LEARNT

Even though the operator had benefitted from the administrative approvals granted to predecessors, the most recent activities performed on the site pertained strictly to the administrative authorisation. As such, a "simple facility" subjected to administrative approvals might have been the cause of major environmental nuisances: PCB pollution, slaughtering of farm animals, etc.

The expert evaluations performed by specialised organisations could take time and in some instances prove difficult to reconcile with the speed of decision-making processes. In the case of Saint Cyprien, farmers grew impatient when faced with a lack of explanation given the stringent measures being imposed. Incompressible timetables sometimes have the effect of delaying modelling work, as exemplified by waiting for soil analysis results. Moreover, very significant divergences in the measurements recorded by certified laboratories may raise interpretation problems.

A sanitation agency has been requested to define the concentration thresholds of PCDD/F and PCB in soils that are capable of leading to animal product contamination.

The absence of environmental sampling dating from the time of the accident was also highlighted as a constraint in the analytical working procedure. Various hypotheses could have been verified had the fodder from 2008 been sampled or had a background reference from the sector been available. In a similar situation, a good reflex might be to very quickly take samples within the accident zone.

This accident demonstrates the consequences capable of being induced by soil pollution on burned parcels.

Oversight of the Saint-Cyprien accident underscores the need for effective coordination between the various administrative departments operating at the State and local levels. The administrative agencies responsible for inspecting classified facilities dealing with waste treatment and with the warehousing and storage of chemical products must remain highly reactive in such cases and never hesitate calling in a third-party specialist.

In particular, tools such as geographic information systems (GIS) are essential in managing this type of crisis that affects an area accounting for 42 municipalities. Access to GIS data managed by different administrative bodies (especially DREAL/DDPP/DDT) should be facilitated and the participation of GIS experts is essential for this type of crisis management.

The decree and order issued on 19 June 2009 (instituting a compensation measure and establishing the protocols for estimating the number of farm animals slaughtered and foodstuffs and products destroyed upon administrative request for a contamination incident involving agricultural products) have made it possible for the State to acknowledge the heaviest impact of pollution, namely the compensation to be paid out for destroying contaminated animals and feed.

In addition, the method of sanitation protocols has been implemented for the first time on this scale with highly positive results. Without it, the slaughter of 2 to 3 times more animals was likely.

In closing, the Agricultural Modernisation Law No. 2010-874 enacted 27 July 2010 authorises, in Article 26, the creation of a national fund for managing agricultural risks (FNGRA), which replaced the previous national funds for managing agricultural disasters (FNGCA). This fund is intended to participate in the financing of management systems for coping with hazards related to climate, health, phytosanitary products and the environment within the agricultural sector.



Break in a liquid hydrocarbon pipeline

7 August 2009

**Plaine-de-la-Crau
(Bouches-du-Rhône)
France**

Releases
Pipeline
Hydrocarbons
Construction flaws
Pollution clean-up
Protected natural zones

THE FACILITIES INVOLVED

The facility involved in this accident is a pipeline featuring the following primary characteristics :

- nominal dimension = 40 inches (102 cm) ;
- service pressure = 40 bar ;
- year of operational start-up = 1972 ;
- annual transport capacity = 35.8 million tonnes of product ;
- length = 714 km.

This pipeline was conveying oil products (crude) for the refineries at Cressier (Switzerland), Reichstett (France), Miro (Germany), for the petrochemical facility at Carling (France), and moving product to Fos-sur-Mer (Provence / Alps-Riviera Coast) / Oberhoffen (Alsace).

The company awarded this pipeline operating license was also responsible for 2 parallel facilities, namely :

- a 24-inch line connecting Fos with Feyzin (length: 260 km) ;
- a 34-inch line (length: 770 km), which was idle at the time of this accident.

At the spot where the leak occurred, the pipeline crossed the *La Crau* Nature Reserve, one of the nationally registered "Natura 2000" sites home to several protected species.



Pipeline alignment through France (RR)

THE ACCIDENT, ITS CHRONOLOGY, EFFECTS AND CONSEQUENCES

The accident :

In order to better understand the chronology of the pertinent events, it is helpful to examine the longitudinal profile of the facility over its first 50 km, as this section features the various remote-controlled shutoff valves (denoted VL1 and VL2) :

Longitudinal profile of the 40" pipeline

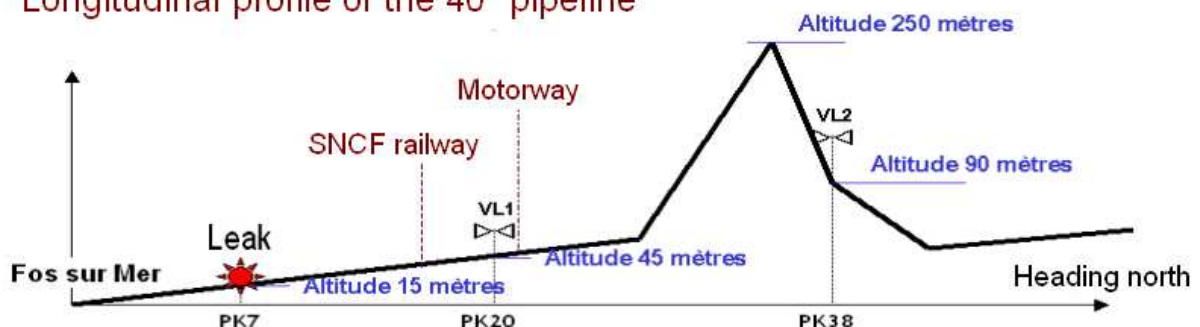

Chronology of pertinent events :

- 7:32 am : A pressure drop was detected in the control room (pressure stall causing a loss from 38 to 2.5 bar). The pumps were shut down automatically. A technician left the premises to inspect valve positions on the line.
- 7:35 am : The pipeline operator received a call from a warden stationed at the *La Crau* Nature Reserve to notify the operator of a leak. However, the information transmitted was insufficient to easily locate the exact spot where the leak had occurred. A rapid procedure for draining the pipeline was initiated.
Since the pipeline had already been shut off, the internal pressure depended solely on the level of relief (i.e. hydrostatic pressure).



Discharge of hydrocarbons (RR)

- 7:50 am : The operator activated the facility's external emergency intervention plan.
- 8:00 am : Response teams were dispatched to the site (at marker PK 38).
- 8:03 am : The valve VL2 in Saint-Rémy de Provence was closed.
The back-pumping operation began.
- 8:24 am : The local fire department was notified.
- 8:29 am : Valve VL1 was closed following confirmation by control room staff of the precise leak location.
- 9:18 am : Fire-fighters and the gendarmerie arrived on the scene and a safety perimeter was set up.
- 1:00 pm : A drainage ditch was dug to the west side of the leak to avoid the risk of horizontal propagation. France's Secretary of State for Ecology made a site visit at 4:30 pm.

The rapid pipeline drainage procedure was completed at 3:40 am the following morning. The volume of hydrocarbons recovered by this method was estimated at 11,794 m³. The task of pumping hydrocarbons that had spilled into the soil began at noon. Many hydro scrapers were deployed for the purpose of recovering oil at the surface during the first 36 hours after the incident.

The emergency plan was lifted by the operator on 10 August at 9 am.

Consequences of this accident :

Environmental impact :

5,400 m³ of crude oil were discharged over a 5-hectare land area amidst the nature reserve. The oil spill was measured by a certified land surveyor.



Polluted zone (SDIS 13, Fire and Emergency Services)

A series of boreholes, consisting of core specimens and analyses of ground samples, were executed in order to assess in depth the impact of pollution over the designated zone.

Since the water table was located between 9 and 12 m belowground, a set of 72 piezometers were gradually installed during the month following the leak in order to monitor the impact of pollution on groundwater; also, a hydraulic barrier was erected to contain any eventual migration of this pollution outbreak.

The analyses regularly conducted by the pipeline operator (at the request of administrative authorities) proved that no water extraction operation at a lower hydraulic level, whether for irrigation, animal drinking water or human consumption, had been adversely affected.

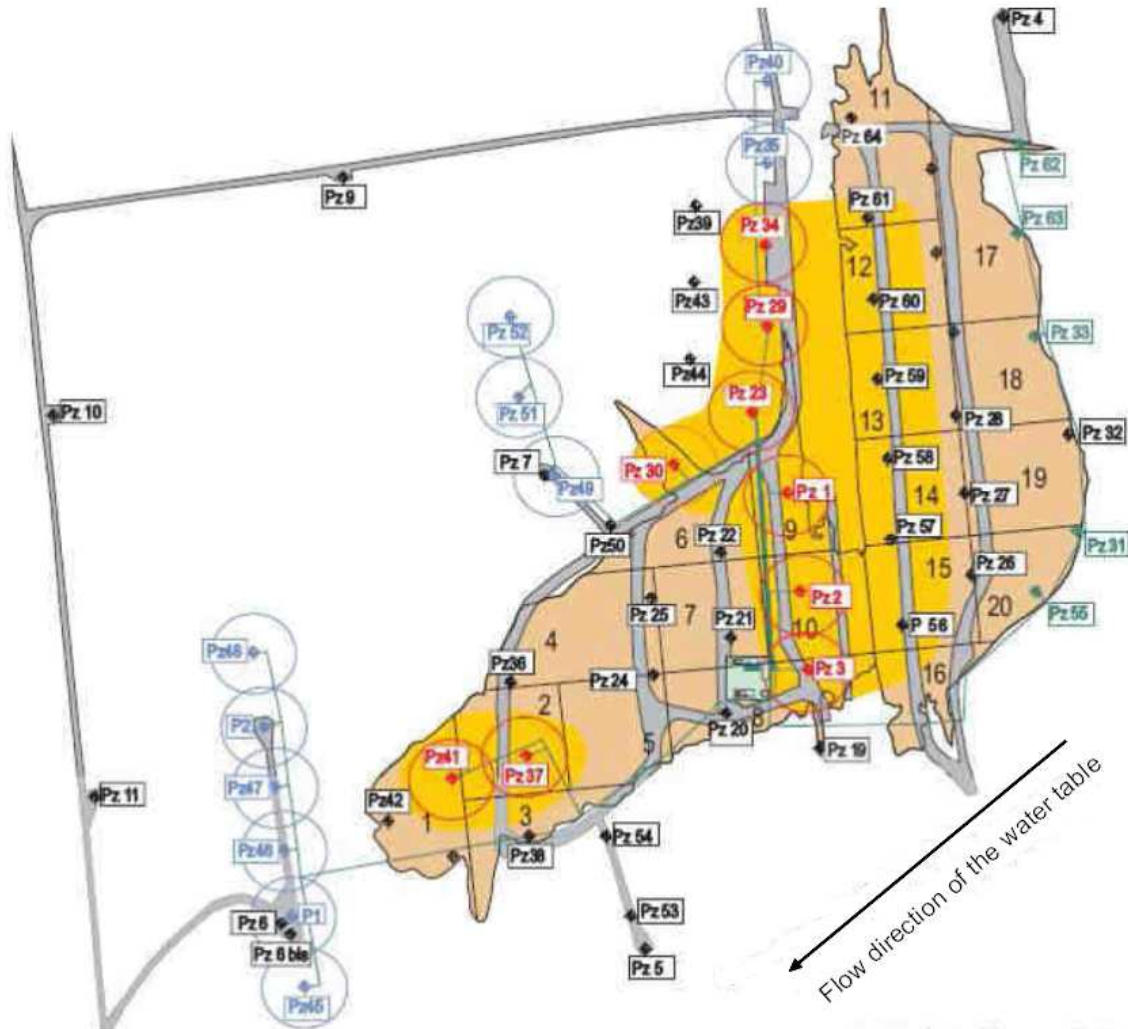

Water table protection plan

RR

Moreover, many studies were undertaken to characterise as accurately as possible the impact of this accident on local flora and fauna found within the nature reserve. Yet the consequences were difficult to evaluate beyond the polluted zone due to lack of a precise reference state, even inside a nature reserve. Flora on the "coussoul" steppe-like plains was destroyed over the 5-hectare area affected by the pollution.



Le Coussoul (steppe) - RR

Economic consequences :

Subsequent to the pipeline shutdown, a supply interruption in crude oil threatened shortages at several refineries: Cressier (Switzerland), Reichstett (Alsace), Karlsruhe (Germany), and Feyzin (France).

To prevent against complete supply blockage, it was anticipated to use the adjacent 24-inch pipeline until reaching St Quentin Fallavier, at which point the flow would have connected back to the 40-inch line after repair and inspection.

This solution, while not supplying the refineries under normal conditions (with a capacity deficit reaching 2,000 m³/hr), was still able to avoid total shutdown of the refining units. The Cressier refinery in Switzerland nonetheless was forced to close due to a lack of product for refining.

One year after the accident, the pipeline operating company announced a cumulative expenditure of €50 million related to consequences of this leak, with tens of millions devoted to environmental restoration.

The European scale of industrial accidents

By applying the rating rules applicable to the 18 parameters of the scale officially adopted in February 1994 by the Member States' Competent Authority Committee for implementing the 'SEVESO' directive on handling hazardous substances, and in light of information available, this accident can be characterised by the four following indices :

Dangerous materials released		<input type="checkbox"/>	<input type="checkbox"/>	<input type="checkbox"/>	<input type="checkbox"/>	<input type="checkbox"/>	<input type="checkbox"/>
Human and social consequences		<input type="checkbox"/>	<input type="checkbox"/>	<input type="checkbox"/>	<input type="checkbox"/>	<input type="checkbox"/>	<input type="checkbox"/>
Environmental consequences		<input checked="" type="checkbox"/>	<input checked="" type="checkbox"/>	<input checked="" type="checkbox"/>	<input type="checkbox"/>	<input type="checkbox"/>	<input type="checkbox"/>
Economic consequences		<input checked="" type="checkbox"/>	<input checked="" type="checkbox"/>	<input checked="" type="checkbox"/>	<input checked="" type="checkbox"/>	<input checked="" type="checkbox"/>	<input type="checkbox"/>

The parameters composing these indices and their corresponding rating protocol are available from the following Website: <http://www.aria.developpement-durable.gouv.fr>

The "Environmental consequences" index was assigned a "3" score since 5 hectares of a nature reserve were polluted ('Parameter H3').

The "Economic consequences" index was scored at a "5" due to the cost involved in site rehabilitation work, which amounted overall to some €10 million ('Parameter €18').

The "Dangerous materials released" index was not rated given that crude oil is not included on the list of products in Appendix 1 of the Seveso Directive.

THE ORIGIN, CAUSES AND CIRCUMSTANCES SURROUNDING THIS ACCIDENT

A "button-hole" opening 15 cm wide and 1.8 m long on a longitudinal weld was the source of this leak. Several hypotheses were forwarded to explain such a pipeline break.



"Button-hole" opening of the 40-inch pipeline (RR)

Roof effect :

Similarities were observed with a previous accident that the Saint-Rémy de Provence site operator had already encountered in 1980 (ARIA 14766), relating to the presence of a tube exposed to the roof effect, with onset of cracking and a break caused by fatigue.

The 40-inch pipeline was composed of 5,190 tubes built by the same manufacturer and capable of exhibiting the same defect. These tubes were located along the southern part of the facility alignment, yet were not necessarily contiguous. Following a measurement campaign using an instrumented scraper, the roof effects associated with these tubes turned out to lie between 0 and 4 mm.

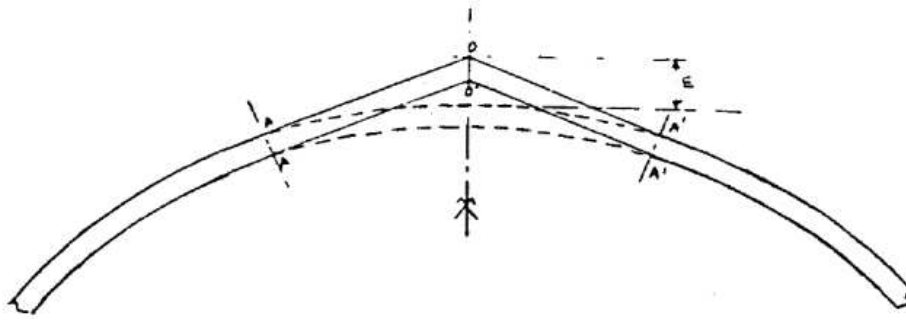
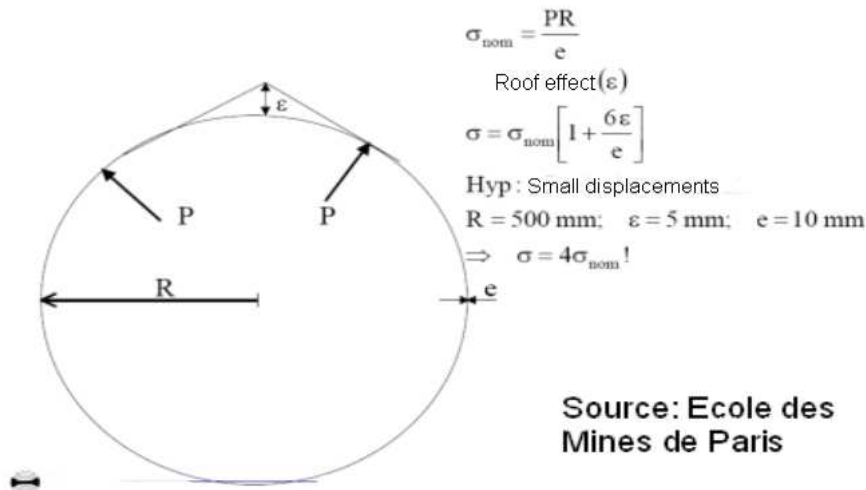

Diagram of the roof effect – RR

A specialised laboratory had modelled the behaviour of tubes displaying a roof effect of no more than 3.5 mm, which were dependent on loading variations caused by pressure variations over time. Tube sections featuring a roof effect above 3.5 mm were singled out for onsite inspection. On the basis of these studies, a strength test designed for 150% of the maximum service pressure was scheduled to be conducted at the beginning of 2011.

The most recent tube inspection had been performed in 2003; five tubes underwent inspection, including the one that eventually burst. These inspections confirmed the presence of roof effects, yet they only varied slightly and moreover no cracks were detected when applying ultrasound techniques.

HARMFUL ROOF EFFECT



Delamination :

Following the accident, a delamination defect was exposed at the level of the longitudinal weld of another tube displaying the roof effect and positioned not far from the tube that burst. The facility operator compared this observation with the results of the 2003 inspection of the broken tube.

According to the 2003 inspection report, at the time of the ultrasound examination, no clue suggesting root cracking on the longitudinal weld could be identified, though delamination zones were still apparent.

The operator submitted these findings to a specialised body for interpretation.

The initial conclusions drawn from this independent expert after analysis of the 2003 inspection report indicated: "The presence of extensive delaminated surface areas on the tube sheet metal at the level of the longitudinal welded joint, precisely in the zone where the break occurred. On its own, this defect is not necessarily deleterious to pipeline operations, yet given its location, 2 major disadvantages arise:

- impossibility of evaluating the integrity of the weld root,
- when combined with a fatigue crack, this defect is of the type to considerably shorten the tube life cycle when exposed to cyclic loadings (e.g. increasing propagation speed of a fatigue crack in comparison with the theoretical model output)."

As a result, delamination might have concealed internal cracks that had formed from the tube interior.

At the request of the facility operator, a laboratory specialised in metallurgy analysed how this lamination could have affected the fatigue phenomenon. This expert organisation concluded the absence of any direct correlation between the presence of delamination and accelerated crack development. Delamination basically played the role of a mask, interfering with the detection of a crack from the external or internal skin.

Characteristics of the steel used to manufacture the tube :

The testing campaign conducted by the specialised laboratory demonstrated that the mechanical characteristics of the broken tube were variable and, in some instances, dropped below the acceptable minimum threshold specified in manufacturing standards, especially regarding some of the resiliency values (characteristic of the steel, representing its capacity to resist crack propagation).

According to the operator, this assessment of the exceptional nature of the break was reinforced when using the instrumented scraper for crack detection in April 2010. During this application, no other tube could be found to exhibit any trace of significant crack onset. The tube that burst thus appeared to be a singular occurrence within the pipeline.

ACTIONS TAKEN

Subsequent to the accident, the primary problems encountered pertained to pollution of the soil, subsoil and water table, as well as the environmental impact on the nature reserve and the need to place the pipeline back into operation given the tremendous economic burden its immobilisation had caused.

A - Soil and subsoil pollution :

The main set of actions undertaken consisted of :

- maintaining safety measures to cope with the elevated risk of fire and explosion ;
- mitigating the event's impact and pollution clean-up efforts on the nature reserve's flora and fauna (given this site's extreme sensitivity) ;
- limiting the impact of pollution on this sector's very sensitive water table (including drinking water supply extraction sites at Port Saint Louis on the Rhone River and Fos-sur-Mer only a few kilometres away, plus agricultural pumping activity at a distance of just a few hundred metres) ;
- rapidly initiating pollution clean-up work and investigations in order to estimate impacts on the nature reserve.

Water table restoration :

As of 19 December 2009, a specialised firm was called onsite to initially skim surface hydrocarbons from 3 wells separated by some 50 metres and lying near the pipe corridor (first zone of the water table to be reached by the spreading of this pollution). In all, 43 additional wells were bored in a pattern that allowed meshing the impacted zone; this network was then completed by a drawdown system (hydraulic barrier). The water suctioned from these wells was channelled to a treatment plant set up onsite, where pollution removal proceeded by means of activated carbon filtration. Following analysis, the treated water could be re-injected into the water table at an upstream location.

In August 2010, 200 litres of hydrocarbons were still being extracted each week from the water table by skimming.

Removal of polluted ground :

The protocol adopted to remove polluted ground required agreements between the nature reserve land managers and the various clean-up specialists so as to protect against any further damage to the site and limit the impacts of clean-up measures.

A number of problems were identified after several days on the job :

- land surfaces that remained "contaminated" due to the crossing of lorries and site vehicles and equipment ;
- polluted dust being transported by wind during lorry loading/unloading.

As of the end of 2010, results indicated that more than 73,000 tonnes of polluted ground had been excavated and transported since 21 August, 2009 to a treatment facility located in a neighbouring department. This debris stemmed from stripping soil from the polluted zone over a depth of roughly 40 cm outside the pipe corridor.

Out of the 73,000 tonnes of ground processed :

- 23,500 tonnes were routed to a site for storing Class 1 hazardous waste ;
- 49,500 tonnes were transported to a biological treatment plant and then reused at the storage depot site as capping material.

By the end of 2010, experts estimated that between 600 and 1,600 m³ of hydrocarbons were still present in the soil based on the various material evaluations performed with their corresponding levels of uncertainty.

B - Service restart of the facility :

To effectively restart operations of the 40-inch pipeline and thus avoid shortages of finished products within the service zones, the operator designed a multi-phased programme :

- The first phase called for restarting pipeline operations with a scaled down activity. Towards this end, the 19 tubes identified as the most critical as regards exposure to roof effects were inspected: 16 of them were reinforced by means of an epoxy sleeve, while the other 3 (including the one that burst) were replaced ;
- The second phase consisted of developing and then implementing an instrumented scraper in order to accurately measure the roof effects ;
- The third phase then entailed rehabilitating the 34-inch pipeline over the southern part to allow switching the material transport route ;
- The fourth phase involved switching the contents of the 40-inch pipeline for transport via the 34-inch line over the southern part of the alignment, while inerting the 40-inch line ;
- The fifth and final phase consisted of removing the tubes identified during the second phase and devising a plan for repairing all tubes displaying a roof effect superior or equal to 3.5 mm, as well as tubes with a delamination defect and effect of roof above 3, 0 mm, to the extent that it is resolved continue to use the work of 40 inches.

Once the set of repairs had been completed on the 40-inch line, the operator conducted hydraulic resistance tests on the various pipe sections. This testing campaign began on 30 November, 2009 in the Provence-Alps-Riviera Coast region and was concluded before Christmas in the Franche-Comte region.

C - Restoration of the directly impacted site :

Over the observed 5-hectare zone, backfilling over a depth of approximately 0.40 m was performed using local materials transferred from a nearby quarry in conformance with the soil's original structure. The surface layer was reconstituted by means of directly transferring some of the "*coussoul*" steppe material extracted on zones not yet quarried. A scientific monitoring campaign had been scheduled to observe the re-composition of this material. These works were completed on 15 April, 2011.



Aerial view - March 2011 - RR



Restored and compacted zone - RR



Spreading of the surface layer - RR

D - Administrative monitoring :

A series of emergency prefectural decrees were adopted beginning on 13 August, 2009 to impose upon the operator a set of conditions required to manage the consequences of this accident. Successive administrative orders prescribed the following:

- suspension of the pipeline transport activity ;
- submission of an accident report within 10 days ;
- transmission of the list of tubes exhibiting the same defects as the one that burst ;
- commissioning of a third-party expert at the expense of the facility operator ;
- maintenance of safety features at the accident site to protect human life, property and the environment ;
- study of the causes and measures to be adopted to avoid repeat of this type of accident ;
- a technical and economic study of all hypotheses for transporting the product ;
- conditions for pollution clean-up and rehabilitation of the affected site ;
- impact studies of this pollution on the environment during both the accident and clean-up work ;

In order to practically address the various environmental problems, several committees were created, i.e. :

- an environmental monitoring committee presided by the Arles Deputy Prefect, who held regular briefings on the state of progress of clean-up operations, in addition to overseeing water table monitoring and communicating with all individual and collective parties involved ;

- executive technical committees for each of the identified problems, assigned to develop action protocols for :
 - cataloguing impacts on flora and fauna, and defining working procedures within the nature reserve ;
 - establishing the set of rehabilitation conditions applicable to the affected site ;
 - managing stormwater and surveying, then cleaning, the water table ;
 - removing pollution from soils and managing land areas.

LESSONS LEARNT

Several lessons have been drawn from this accident:

Ageing of installations :

Confronted with the succession of accidents that occurred towards the beginning of 2009 in both the chemical and oil industries, as well as in the pipeline transport of hazardous materials, a forum was organised on the theme of industrial safety and environmental protection challenges in September 2009 between the Secretary of State for Ecology and the principal leaders of these sectors. These influential industrialists formulated a series of proposals aimed at improving the safety of their equipment by, among other things, reinforcing controls on installation ageing and maintenance, while making the commitment to pay closer attention to ecologically sensitive zones in an effort to enhance efforts to protect vulnerable species or zones.

In August 2010, one year after the accident, the Secretary of State for Ecology provided an assessment of the measures adopted over the previous year to improve pipeline safety. The action plan intended to limit the risks tied to equipment ageing, launched on 13 January 2010, called for increasing inspection frequency and better identification of natural areas. All pipelines displaying a roof effect, which was the defect found on the damaged oil pipeline, were required to undergo an inspection by 2012.

Installation inspection and monitoring :

Beyond the problem associated with works conducted adjacent to facilities, the *La Crau* accident provides an effective illustration that an abrupt break may also occur under other circumstances. In this instance, the inspection methods introduced were apparently insufficient to detect in a timely manner the defects capable of arising during operations.

Moreover, the tube had been exposed to a delamination flaw, which, even if it does not undermine the tube's mechanical strength, can still create difficulties in the process of locating other more significant defects. During ultrasound inspections, the signal emitted when the scraper made its pass actually corresponded to the initial delamination flaw intercepted by the ultrasound beam. A weak, yet representative, signal of an unacceptable defect may be concealed by a stronger signal that may correspond to an acceptable flaw.

Site clean-up :

Time is a determinant factor in the effort to mitigate environmental impacts given that hydrocarbons infiltrate into the soil, since increased land area contamination requires additional treatment and in turn threatens the water table.

To follow up on the *La Crau Plain* accident and under the banner of experimentation, in August 2010, the Secretary of State initiated a project intended to create adjacent to the affected zone a reserve of natural assets that enable compensating for the negative impacts on biodiversity.

This mitigation operation, coordinated by a specialised firm, consisted of restoring the habitats of rare and threatened species by transforming an industrial orchard into pastureland. This experiment, designed to last 3 years, comprised 4 sites located within different ecological settings.

Accident statistics have been recorded from many cases of leaks on pipelines transporting hazardous substances :

ARIA 168 - Accident at Rosteig (France), 28 July 1989

ARIA 14768 - Accident at Grenoble (France), 18 January 1984

ARIA 35176 - Accident at Appomattox, Virginia (United States), 14 September 2008



Massive alumina red sludge release after the failure of a containment dam

4 October 2010

Kolontár
Hungary

Aluminium
Dam
Environmental impact
Transboundary effects
Crisis management
Water pollution

THE FACILITIES INVOLVED

The site :

The aluminium plant is located in Hungary around 100 km south-west of Budapest in the surrounding area of Ajka town. Established in 1995 at the time of the privatisation of the Hungarian aluminium industry, the company became the owner of the formerly state owned plant that has been in operation since 1942. During the privatisation the company managed to get involved in all sectors relevant to aluminium production (bauxite mine in the Bakony, alumina plant in Ajka, aluminium smelter in Inota). 75% of the company's products are exported to Western Europe. It has been active in neighbouring countries (Slovenia, Romania, and Germany) with the purchase of companies with related profiles.



1. Location of the site

RR

The involved unit :

The plant placed the red sludge into tailing ponds in the Torna Creek's valley between Ajka and Kolontár. Between 1943 and 1968 the red sludge was brought to Reservoirs 1-4 inside the premises of the factory. After 1967 six new reservoirs (5th -10th) were built west from the factory. The Reservoir 10, where the accident occurred has been in use since 1998.

The factory is located on a 49 hectare land, and the reservoirs cover a further 207 hectares. Reservoir 10's volume is 4.500.000 m³ and its base is on 19 hectares. The height of the dam walls is between 21-25 metres, and the width is 10 metres at crest.



2. Satellite view of the Reservoir 10 and Kolontár before the accident

RR

THE ACCIDENT, ITS CHRONOLOGY, EFFECTS AND CONSEQUENCES

The following description of the accident, as well as information on the causes, actions taken and lessons learnt, are based on the elements provided by the Hungarian authorities.

The accident :

At around midday on 4 October 2010 a breach occurred in the dam wall (app. 50 metres long) holding back red sludge in containment Reservoir 10. The strongly alkaline water produced through the Bayer process for the treatment of bauxite, containing residues of aluminium and toxic metals, immediately flooded the town of Kolontár, then Devecser and other towns. Instant response was necessary to protect lives and property, and to preserve natural assets and agricultural areas.

The red sludge itself is a residuum of aluminium production. Around 24-45 percent of the red sludge was ferrous oxide, other metallic compounds (aluminium oxide, titanium dioxide, silicon dioxide, sodium oxide and calcium oxide) were also contained, and less than one percent was rare earth metal oxides. The red sludge also contained sodium hydroxide, which is a caustic base.

As the result of the rupture of the dam wall, the Torna Creek and its valley were contaminated by the estimated amount of over 1 million m³ of alkaline red sludge. The pollution plume reached the MARCAL River at 6:00 pm on the same day, in which the recent flood wave was already decreasing, therefore the transport of the pollution fortunately slowed down. In the morning of the 5 October a warning message was sent out to the DANUBE basin countries by Hungarian national centre (PIAC) through the Accident Emergency Warning System (AEWS) of the DANUBE Protection Convention. The head of the plume passed the village of Mersevár at 3:00 pm on the same day.



3. Dike breach

RR



4. Contamination along the TORNA Creek

RR

For the mitigation of the environmental damage, the Environmental and Water Directorates involved (Székesfehérvár, Szombathely, Győr) ordered emergency preparedness state on the same day. From 4:00 pm on 4 October the highest alert (level III.) has been in force along the TORNA Creek and MARCAL River on a total length of 92.3 km.

At the Governmental Coordination Committee meeting held at 4:00 pm on 5 October 2010, decision was made about the immediate reconstruction of the levee of the tailing pond and about the further treatment of the residues of red sludge in the area.

In the framework of the mitigation activity in order to reduce the alkaline effect, gypsum has been spread since the morning of the 5 October in the village Kolontár, later in Devecser and Somlóvásárhely as well as into the MARCAL River at the bridge between Szergény and Vinár. The spread of the material was later continued from aeroplane. At the downstream section of the MARCAL River (at 22 river km) gypsum-depot was created at Móríchida. Water jets were used to increase efficiency of the mixing of the gypsum and the pollutant.

Hungary took intensive measures on the whole length of the MARCAL River before the arrival of the pollution plume to settle down the suspended solids possibly contaminated by heavy metals. For this reason decision was made to construct 7 so called “riverbed barriers” (artificially created obstacle under water – on the river bottom - to stop the heavier fractions of contamination (the red mud) in the riverbed).



5. Riverbed barrier

RR

In order to reach a tolerable level of pH, an intensive neutralisation process was going on at the end-section of MARCAL River (upper of its confluence). It was achieved by neutralisation effect of bio-acetic-acid. The water reached the DANUBE after further dilution process in the RABA and the MOSONI-DANUBE Rivers only, where neither water quality problems nor harmful to health effects were detected. Consequently Hungary could successfully avoid severe alkaline and heavy metal pollution of the RABA and DANUBE rivers.

The Hungarian State's priority aim was to keep the pollution plume inside the territory of the country, to localize the mud in the Marcal river bed and to prevent pollution plume to reach the Danube River via Rába River and MOSONI DANUBE.

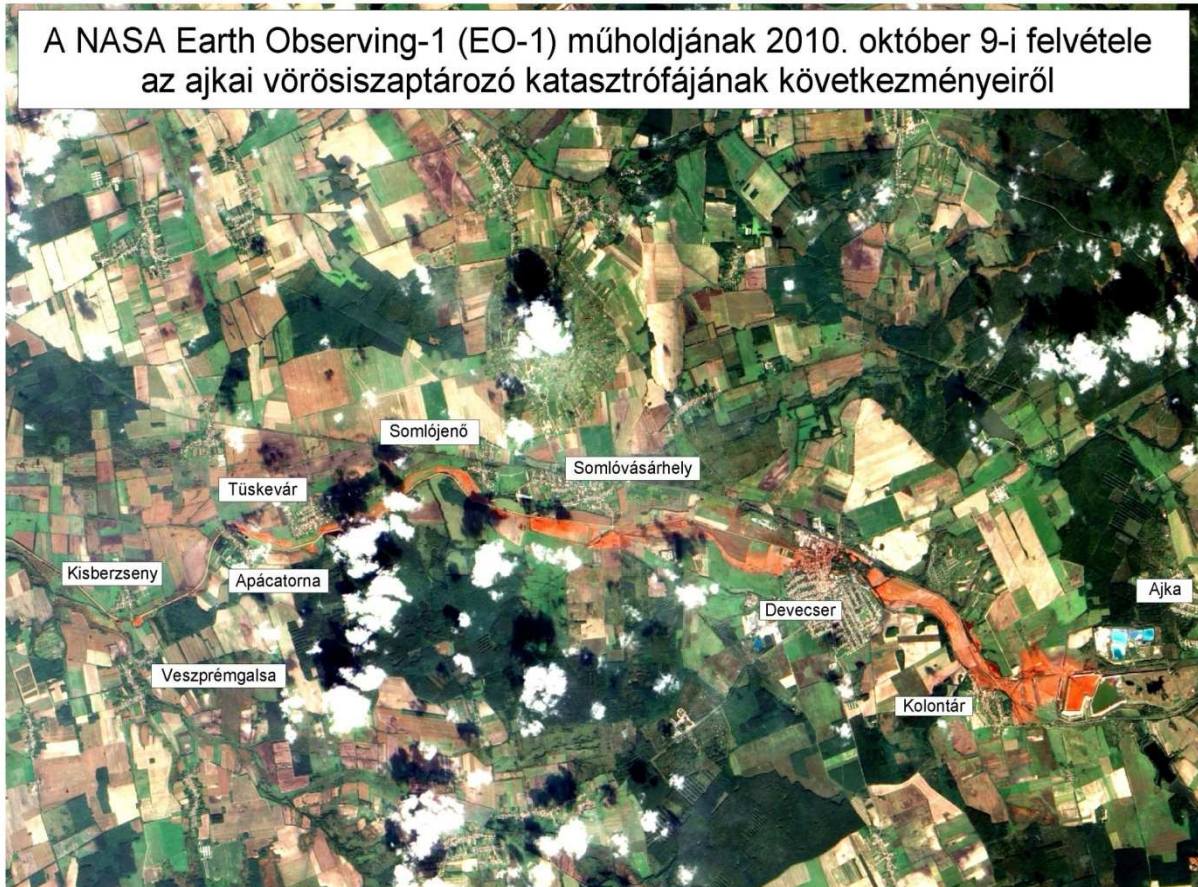

6. Satellite image of the area (9/10/2011)

RR

The effect and risk of the dust-polluted air was continuously controlled by the environmental agency and the public health institute. The risk communication was represented by the Government and the Ministry for Interior.

Consequences of the accident :

The accident was the most severe industrial catastrophe in Hungary’s recent history, with 10 fatalities, 286 injured persons (121 required treatment in hospital) and major environmental and economical damages. There were 51 houses in Kolontár, 275 in Devecser and 39 in Somlósárhely damaged by the red sludge, and a thousand hectares of soil contaminated. 284 houses were irreparable and must have been demolished. Also the TORNA Creek’s and the MARCAL river’s ecosystems were seriously affected.

As we are still in the time of constant interventions, long run impacts cannot be estimated accurately.

The European scale of industrial accidents :

By applying the rating rules applicable to the 18 parameters of the scale officially adopted in February 1994 by the Member States’ Competent Authority Committee for implementing the ‘SEVESO II’ directive on handling hazardous substances, and in light of the information available, this accident can be characterised by the four following indices:

Dangerous materials released	1	<input type="checkbox"/>	<input type="checkbox"/>	<input type="checkbox"/>	<input type="checkbox"/>	<input type="checkbox"/>
Human and social consequences		<input checked="" type="checkbox"/>	<input checked="" type="checkbox"/>	<input checked="" type="checkbox"/>	<input checked="" type="checkbox"/>	<input checked="" type="checkbox"/>
Environmental consequences		<input checked="" type="checkbox"/>	<input checked="" type="checkbox"/>	<input checked="" type="checkbox"/>	<input checked="" type="checkbox"/>	<input checked="" type="checkbox"/>
Economic consequences		<input checked="" type="checkbox"/>	<input checked="" type="checkbox"/>	<input checked="" type="checkbox"/>	<input checked="" type="checkbox"/>	<input checked="" type="checkbox"/>

- Parameter Q1 is 1, as the red sludge includes in small quantities hazardous substances
- Parameter Q2 is 0, no explosive substance was involved
- Parameter H3 is 6, 10 casualties, but all persons from the public
- Parameter H4 is 6, 121 hospitalised mostly persons from the public

Parameter H5 is 6, over four hundred injured were treated by medics on site

Parameter H6 is 6, 365 houses and other buildings were damaged

Parameter H7 is 6, as initially over 800 residents were evacuated, many of them couldn't return as their houses must have been torn down due to heavy damages

Parameter H8 is 2, there were just minor interferences with the public utilities

Parameter H9 is 6, as all residents and rescue personnel must attend regular health checks since then, as recommended by the World Health Organisation

As for parameter Env10, Env11 there is no data available, assessments are still in process for estimates, but no results yet

Parameter Env12 is 6, as over 10 million m³ of water was contaminated

Parameter Env13 is 6, around 1000 hectares were contaminated

Parameter €17 is most likely 6, but there are no accurate estimates available to specify concrete sums

Parameter €15, €16 and €18 cannot be determined properly yet as the assessments are not finished

The parameters composing these indices and their corresponding rating protocol are available from the following Website : <http://www.aria.developpement-durable.gouv.fr>

THE ORIGIN, CAUSES AND CIRCUMSTANCES SURROUNDING THE ACCIDENT

On the 4 October 2010 at 12:30 the western dyke of the Reservoir 10 broke and approximately 1,000,000 m³ of red sludge and alkaline water flooded the lower parts of Kolontár, Devecser and Somlóvásárhely through the TORNA Creek.

At the time of the accident the aluminium factory still used a so-called wet technology, which was quite outdated and resulted in producing the red sludge during the production process. It must be highlighted that the tailing ponds did not simply function as waste containers, but were part of the production process (the liquid phase was reused from the tailing). That is the reason why not only the solid and otherwise quite harmless red sludge was in the reservoir but also a considerable amount of alkaline water. During the production the alkaline was collected and deflected back through a tube system into the factory for further use.

One of the reasons that led to the accident was the extreme amount of rain in the year 2010. It was the source of numerous agricultural and environmental problems all over Hungary in that year. The extreme quantity and the intensity of rain resulted in huge agricultural areas covered with inland waters and caused floods in some areas where it was unprecedented before. The enormous amount of rain that fell on the top of the red sludge in the Reservoir 10 further increased the pressure on the wall of the dam. It worked as a catalyst in the dike's erosion process and finally led to the breach of the wall.

The reasons behind the fatalities and the injuries of the accident came from two different sources. First of all the weight, the speed and the amount of the flood waves pouring out of the reservoir was the cause of the casualties and traumatic injuries. It was also responsible for the physical damages of the houses, roads and the railways. The alkali mixed with water and the sludge was responsible for the high pH level of the mixture, which resulted in chemical burning injuries and chemical damages on property.

ACTIONS TAKEN

According to the severity of the accident rapid action was required from the Hungarian Government, with the joint actions from the Ministry of Internal Affairs, the National Directorate General for Disaster Management and the Ministry of Rural Development. The exemplary work of the local population, local councils, civil defence organisations, the fire department, environmental protection activists and hydrological experts must be highlighted.

Immediately after the accident the Official Fire Department of Ajka arrived to the scene with 84 men in 12 vehicles. They were followed by further 103 policemen with 22 vehicles, 174 soldiers with 43 vehicles, 41 officials of the directorate for disaster management with 20 vehicles, five persons from the public health service with 2 vehicles, 149 civilians with 43 vehicles and 50 workers. In November 2010 all together 8535 persons and 4881 technical devices worked at the scene of the accident.

Assessment of water quality in the area began immediately: measures were taken of the water temperature, pH values, specific conductivity and levels of dissolved oxygen, and water levels monitored continuously. The assessment included evaluation of general water chemistry, toxicity and metal content.

Over the course of four days (9-12 October) teams of construction professionals built a defence dam (Dam Number 1) 620 metres long, 2.75 metres high and 6.8 metres wide near the ruptured sludge container. After constructing the defence dam, hydrological experts began work on temporarily sealing Reservoir 10. The breach has been completely closed with tiered ring dam walls with water outlet capacity. The six cascade basins formed by the ring dams safely drain alkali water from the damaged reservoir, while holding back red sludge.

From the end of November until the end of December the permanent defence dam (Dam Number 2) was built with 1,300 metres in length and 4.5 metres height. Along the entire length of the base of the dam wall a waterproof barrier wall was built, extending down below the ground surface to the base stratum of clay (6-9 metres)

Protection of water quality also demanded immediate action. The most important measures were neutralisation of water and the capture of floating matter containing heavy metals. Gypsum (23,500 tonnes) and acetic acid (cc. 1,800 m³) were used to reduce water pH levels. The mixing of gypsum as it began to be applied was aided by the use of high-pressure fire-hoses and aeration equipment. In the settlements involved gypsum was also added directly on affected areas.



7. Decontamination (gypsum dispersion, below Kolontár Bridge)

RR

In order to capture solid pollutants, so-called “riverbed barriers” were constructed on the River MARCAL, the TORNA Creek and the MALOM ditch. The deposit of boulders in water slowed down the flow of water – reducing it to a third of its previous speed in places – and caused sedimentation of harmful red sludge.

As the sludge destroyed and permanently damaged many houses in Kolontár, Devecser and Somlóvásárhely, there was a need to help the owners of the real estates, as they suffered a great loss. Considerable amount of dedication was shown, as the Hungarian Government, NGOs, companies and individuals offered their financial and material support. A lot of help was received from abroad as well.

The red sludge also flooded around 400 hectares of agricultural land. Because of its high pH level and high percentage of metallic compounds these fields were seriously damaged and became incapable to produce healthy farm products. The top two centimetres of the soil was cleared and remediated everywhere in the affected area. The more heavily contaminated soil was cleaned up and brought to an officially designated dumpsite (cc. 730.000 m³). In those areas where the contamination did not affect the soil so significantly, the agricultural authority (soil conservation service) decided to use acidifying organic soil improvers i.e. “dudarit” (humic mineral) to neutralize the alkaline and improve the soil function.

As planting for human or animal feeding is still not permitted, rehabilitation of the contaminated land is continuing with the cleanup processes, using the above mentioned organic soil conditioners and soil fertilizers, and with the cultivation of “E-grass”, plant that is less sensitive than other crops and is a major source of renewable energy. The strategy of the Hungarian Government in order to help to recover the area is to establish a centre for renewable energy with energy plant fields. This would create jobs and provide the surroundings with sustainable energy.

The company’s IPPC permission was issued in 2006, and was valid until 28 February 2011. The company had to shift to the use of the dry technology in order to receive the new permit for further five years. As a result the pH level of the residuum decreased from 13,6 to 10 and the percentage of water from 75% to 25-30%. This means that the red sludge is less liquid and less alkali, therefore the chance of a similar accident has significantly decreased.

The accident in Kolontár showed the risk, what the remedies of mining sites were representing, that is why the Hungarian Government decided to run a grand scale assessment on the operating mining waste deposition sites. All the relevant authorities were involved throughout the country and they had to report on their findings. The assessment of the reports is still not completely finished but all necessary measures have been taken to prevent another accident.

As the damages caused by the accident proved to be major, the Hungarian government decided to establish a financial fund in order to help financing the reconstruction of the destroyed villages and homes. It was called the Hungarian Compensation Fund. There was a massive dedication shown from Hungarians and foreigners who helped the people involved through this fund.

LESSONS LEARNT

According to the severity of the catastrophe, extensive investigations were trying to assess the causes of the accident, and also the question of responsibility. The accident was the subject of an investigation by a Committee of the Hungarian Parliament, the National Investigation Office, the police and the Parliamentary Commissioner of Future Generations (Ombudsman). Also civil law and criminal law proceedings are on-going in front of the Hungarian courts regarding responsibility. As most of these investigations and legal procedures are not finished at time of writing (June 2011), official conclusions are not yet available.

The investigation of the Ombudsman of Future Generation was concluded in January 2011, and so far this is the only relevant evaluation of the accident. The main focus of the Commissioner's analysis was on the legal environment of the factory, and what were the deficiencies of the permission and supervision process of the aluminium factory.

As the investigation of the Ombudsman has already noted there were some legislative loopholes regarding mining waste in the Hungarian legal system. After the incident the Government analysed the relevant regulations, and as the result of this investigation amendments were accepted to the current laws and decrees. These changes clarified the situation of the mining residues and by-products and also managed to ensure the better implementation of the relevant EU law. As a result the legal situation became clear, and now the District Mine Inspectorates are the responsible authorities in the cases of the tailing ponds.

The accident in Kolontár also highlighted, that the regulation in the European Union regarding the red sludge is not exactly clear. Hungary initiated the amendment of the relevant EU law. According to the Hungarian proposition if the red sludge is not the result of the dry technology, but the residuum of the wet method, then it should be labelled as hazardous waste. At the time of the accident it was not clearly stated, but there was a possible choice between hazardous and non-hazardous waste.

The case confirmed the high level of risks of the tailing dikes and the unpreparedness of the company for a catastrophic situation. The company had a damage prevention plan, but it was designed for a much smaller scale of accident (i.e. leakage or overflow of the reservoir) and not a catastrophe where the inhabitants of the area can be threatened.

In order to better avoid the problems resulting from such an accident, the Hungarian government realised it must be compulsory for all companies who are dealing with hazardous material to have insurance covering for such incidents as well.

Since the accident the Hungarian Government lost no time to act (securing the site and the townships involved, intensify authorities supervision, revise legislation concerned, etc.) in order to lower the risk of another incident like this happening again to a minimum.

Explosion of a superheater within a steam-cracking unit

15 July 2009

Saint-Avold (Moselle)

France

Petrochemical industry
 Gas explosion
 Ignition/start-up
 Instructions
 Automatism/regulation

THE FACILITIES INVOLVED

The site :

The installation, located in Saint-Avold (France's Moselle Department), had been incorporated into an extensive industrial platform spanning over 340 hectares. The site was initially created in 1954 to combine a variety of activities related to the chemical and petrochemical sectors (see Fig. 1). The petrochemical operations at this facility were developed during the 1960's, with the 1969 start-up of a first steam cracker along with a polyethylene manufacturing plant a key moment in the life of this facility.



Fig. 1: Exterior view of the site (RR)

Using naphtha (light petroleum distillate) as the input material, the site manufactured basic petrochemical products (ethylene, propylene, methane), which then served as raw materials for the site's production of plastics (polyethylene, polystyrene).

This facility incorporated many installations that required special easement approvals ; it had been classified as an upper-tier "SEVESO" site due to the quantities of inflammable and/or toxic substances manufactured and handled.

The specific unit involved :

The steam cracker occupied the heart of the site. A light petroleum distillate, of the naphtha type, would undergo a cracking reaction at high temperature in the presence of water vapour in order to fragment the molecules into even lighter compounds.



Fig. 2: View of the unit's two superheaters (RR)

This facility comprised many pieces of equipment and machinery, including two superheaters (Fig. 2). Their role was to increase the temperature of vapour produced in the cracking furnaces so as to eliminate water droplets, through the use of 7 burners fed by a fuel oil-gas mix. This overheated vapour then served as the driving force behind the main cracked gas compressor (Fig. 3).

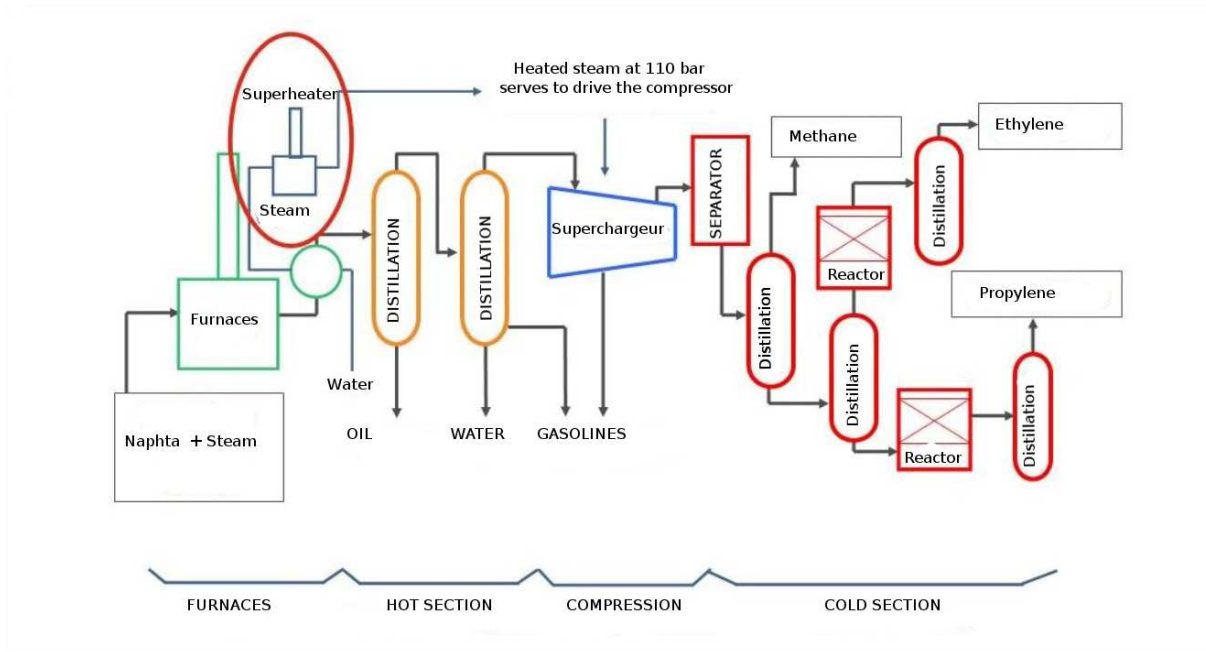

Fig. 3: Operating diagram of the steam cracker unit

THE ACCIDENT, ITS CHRONOLOGY, EFFECTS AND CONSEQUENCES

The accident :

Subsequent to a series of violent atmospheric precipitations during the night of 13 July 2009 to 14, combined with water infiltration causing damage to a utility room and disturbing the digital command and control system (damaged electronic cards), the steam-cracking line was shut down and placed in safety mode.

The line restart procedure was initiated on the morning of 14 July. On 15 July, the superheater was reset around 3 pm with the intention of manually lighting the burners. A technician, holding a mobile pole, took a position underneath the floor plate in order to light the pilot burners when the superheater exploded.

Consequences of this accident :

A total of eight victims were reported onsite :

- 2 deaths (both company employees), found below the superheater floor plate due to its collapse ;
- 4 injured (2 company personnel + 2 temporary workers), with second-degree burns ;
- 2 subcontracted employees at the scene, who were indirectly hurt (both sustained shock).

Property damage was confined to the superheater and its immediate vicinity (Fig. 4).



Figure 4 : View of damage sustained on the upper part of the superheater and collapse of the floor plate (DREAL Lorraine)

This explosion did not however produce any consequences outside the site and moreover in no way compromised the interests addressed in Article L. 511-1 of the French Environmental Code, namely :

- on environmental and health-related conditions, no exterior impact beyond the noise directly due to the blast, as well as the emission of a very short-lasting dust cloud resulting from the projection of refractory material, could be observed. The exploded superheater did not contain any toxic products (given its design as a steam superheater) ; moreover, the explosion was not followed by a fire.
- from the standpoint of accidental risks to third parties and given the amount of property damage, the pressure surge impacts were confined to the superheater's immediate vicinity. Broken glass was observed on the windows of a number of vehicles parked at an onsite lot some 50 metres across from the exploded superheater. This broken glass was most likely caused by either spewing refractory bricks that had lined the inside of the superheater or the excess pressure wave. Refractory debris and fragments, some reaching 50 cm in size, were found around the installation and up to 100 metres away. No risk however was generated in the form of a domino effect at other site installations.

The European scale of industrial accidents

By applying the rating rules applicable to the 18 parameters of the scale officially adopted in February 1994 by the Member States' Competent Authority Committee for implementing the 'SEVESO' directive on handling hazardous substances, and in light of information available, this accident can be characterised by the four following indices:

Hazardous materials released						
Human and social consequences						
Environmental consequences						
Economic consequences						

The parameters composing these indices and their corresponding rating protocol are available from the following Website : <http://www.aria.developpement-durable.gouv.fr>

The "Hazardous Materials Released" index only received a "1" rating due to the small quantity of explosives involved (i.e. the quantity of natural gas < 0.1 tonne).

The "Human and Social Consequences" index was rated a "3" due to the deaths of 2 technicians and injuries sustained by 6 others.

The "Environmental Consequences" index was not rated given the absence of any impacts on the environment.

The "Economic Consequences" index scored a "4", based on the total destruction of a superheater, coupled with significant production losses resulting from the imposed 8-month plant shutdown.

THE ORIGIN, CAUSES AND CIRCUMSTANCES SURROUNDING THE ACCIDENT

At the time of this accident, the steam-cracking line had been undergoing a restart phase subsequent to a number of foul weather incidents that had occurred the day prior (during the night from July 13th to 14th, 2009). The procedure mandated was relatively long, with the start-up sequence being conducted section by section. The superheater was in the ignition phase when the explosion occurred.

According to the site operator, this accident resulted from the simultaneous occurrence of two factors :

- an accumulation of inflammable gas, yet within the flammability limit: the operator's investigation pointed to the hypothesis of a gas flow surge in the direction of a burner during the start-up phase as the ignition step was being carried out ;
- ignition of the cloud by either the tube ignitor or a hot spot inside the superheater convection zone. Other ignition sources could also be envisaged (e.g. electric spark, static electricity), yet these two cited sources would seem the most plausible.

A number of elements favoured the onset of this accident, whose serious consequences were tied to the presence of personnel in the vicinity of the superheater during manual ignition :

- failure to steam-sweep the superheater prior to its re-ignition, as stipulated in the operating procedure issued by the plant management ;
- gas input via a burner, despite the flame on the associated pilot being extinguished ;
- the technical safety system, which prevented supplying burners with gas in the absence of a pilot flame, was not operational. This system was composed of an automated mechanism that closed the gas supply valves in the event the flame detector was not triggered following a 10-second time delay. This mechanism would have been by passed due to its perceived lack of reliability within the specific environment of this superheater. Such a reliability loss could have caused the superheaters to behave erratically and led to repeated shutdowns/start-ups of the steam cracker, hence a greater number of transient phases (keep in mind that a steam cracker shutdown remains exceptional, since it is normally operating continuously).

ACTIONS TAKEN

Government inspectors for industrial facilities arrived on the scene within a few hours after the accident. Subsequent to the observations recorded, a number of emergency measures were imposed upon the operator by the local Government authority. These measures were intended to make start-up of steam-cracking line installations contingent upon :

- submission of the accident report on the superheater explosion ;
- release of the safety report update specific to this part of the steam cracker ;
- presentation by a certified body of a set of elements proving the good working order of all plant equipment either directly or indirectly affected by this accident.

The facility was also placed on notice over failure to comply with a number of specifications laid out in the Gov. authority decree regulating operations of the facility's steam-cracking line, namely :

- performing a steam sweep prior to reigniting the superheater ;
- measuring flammability prior to restarting the superheater ;
- implementing a safety feature that activates in the event of pilot flame extinction on superheater burners.

LESSONS LEARNT

This accident led the site operator to completely modify the ignition sequence of a superheater in order to limit the risk of repeating such an accident, in terms of both probability of occurrence and consequences; these efforts consisted of :

- introducing a programmable and servo-controlled automaton requiring all start-up stages to be performed, namely :
 - o steam sweeping ;
 - o pilot ignition ;
 - o burner ignition.
- setting up a control chart that comprises, among other things, the pilot lighting sequence and the procedure for remote-controlled valves. This measure made it possible for personnel to initiate the superheater ignition sequence remotely, thus limiting their exposure in the event of explosion.

This accident also provided the opportunity for an effective round of collaboration between the teams responsible for site inspection and the team supervising pressurised equipment, even though this factor was quickly eliminated as a potential accident cause. The ensuing collaboration served to streamline information exchanges and raise the calibre of corresponding analyses. Similarly, close collaboration was quickly established between labour inspectors and the classified facilities team.

As a final point, despite an event qualified as a "workplace accident" with no impacts felt outside the facility, management of this accident and its consequences heavily mobilised local teams of the French environmental administration. Media coverage, along with the assigned judicial investigation, also contributed significantly (Fig. 5).

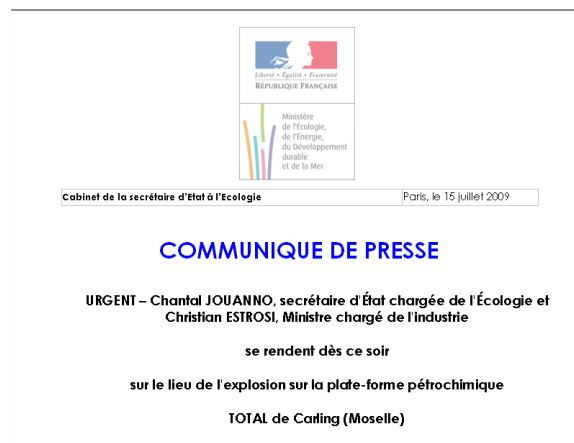

Figure 5 : Press release on the site visit by a delegation of Cabinet members following the accident

Derailment of LPG tank-wagons followed by a UVCE explosion and an intense fire

29 June 2009

Viareggio

Italy

Transport of hazardous materials
LPG
Maintenance
Tanker-wagon
Explosion (UVCE)

THE FACILITIES INVOLVED

The site :

The accident happened nearby an Italian railway station, in June 2009. The station serves the city of Viareggio, in the region of Tuscany, central Italy. Opened in 1936, it is along the Pisa–La Spezia–Genoa railway line (Tyrrenic coast line), and is also a junction for a secondary railway line to Lucca. The station is managed by the national infrastructure manager. Train services to and from the station are operated by different railway undertakings authorized by RFI (now by ANSF - Agenzia Nazionale per la Sicurezza Ferroviaria).

Due to its position, the station is one of the most important in the north-centre-west coast of Italy and in particular in the Province of Lucca, and it is an important junction connecting Pisa, Livorno and Rome with La Spezia, Genoa, Parma and Milan, providing interchange for passengers to and from all of these cities.

On the 29th of June 2009 (day of the accident), the 50325 train was transporting LPG from the oil refinery of Treocate, near Milan, to a LPG storage depot located in Gricignano, near Naples. The train was crossing the Viareggio’s railway station shortly before midnight.

The involved unit :

The train was composed of fourteen rail tankers loaded with LPG, each one with a nominal capacity of 110 m³ and loaded with 45 t of LPG [2] [5].

The tankers were all leased by an international rolling stock operating company to an Italian railway undertaking and were built between 2003 and 2006. The lead rail tanker was registered to a Polish railway undertaking and the other 13 to a German rail and distribution group. Each wagon was equipped with 4 wheel-axes, 2 in front and 2 at the rear (fig. 1) [5] .

The first rail tanker, which derailment created the LPG release, was a cylindrical tank model 462 R (fig. 1), 15,95 m long and 3,04 m of diameter [5]. The derailment was probably caused by the rupture of one of the wheels axes.

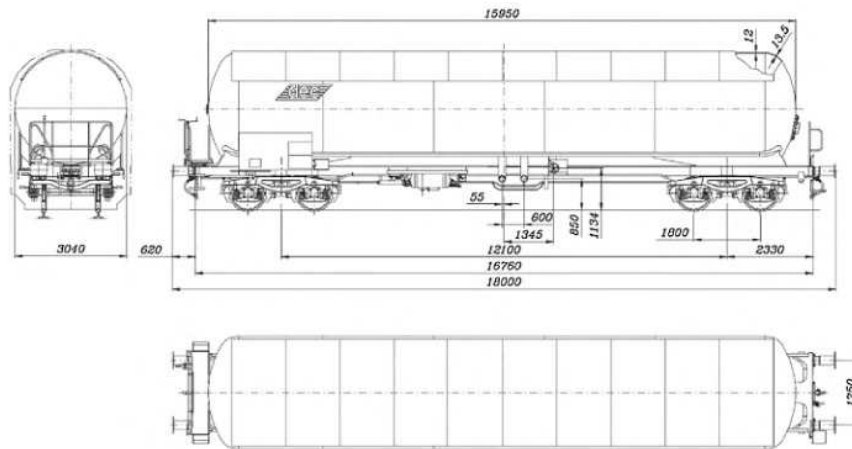

Fig. 1: Rail-tanker 462 R geometrical characteristics (mm)

Tare [t]	33,5
----------	------

Max speed loaded [km/h]	100
Max speed unloaded [km/h]	120
Max loading per axe [t]	20
Max loading [t] at operative speed of 100 km/h	A=30,5, B=38,5, C=46,5
Total capacity [m3]	110
Design pressure [bar]	25
Working pressure [bar]	25
Test pressure [bar]	25
External overpressure [bar]	1

Tab 1: Rail-tanker 462 R technical form (GATX). Categories A, B, C are referred to the International Wagon Regulations (RIV).

THE ACCIDENT, ITS CHRONOLOGY, EFFECTS AND CONSEQUENCES

The accident :

On the 29th of June 2009, shortly before midnight, the 50325 train derailed while crossing the station of Viareggio and five of fourteen rail tankers overturned (fig. 2) [4]. The train was travelling at about 90 km/h (below the speed limit set at 100 km/h) [1] [5]. The first rail tanker plowed the ground and breached probably after the hit with a signaling stake beside the railway or with a rail switch (this point is at the time of writing under investigation during the trial) : the impact caused a hole, about 40 cm long and about 2 to 5 cm wide [3] [2], from which all the LPG escaped (45 t). No loss of containment occurred from the other 13 rail tankers vessels.

The LPG was released: the liquid phase formed a boiling pool on the ballast while the dense gas started spreading and evaporating in the atmosphere. Some people living in the surrounding could hear a loud noise like a gas emitted by a valve, and went to the open windows to see what was going on. They could see a white and short cloud of gas that was moving towards their houses. The dense gas cloud moved radially from the derailed tank mainly across the railway line, due to the rather calm weather conditions. Meteorological conditions at the moment of the release were: 22°C, 92% relative humidity, stability class F, wind almost absent (on the seaside, wind at 0.3 m/s blowing towards the E-SE direction was recorded at the moment of the accident) [4].

The gas cloud found its way towards via Ponchielli, which is a narrow and long street parallel to the railway line with more than forty houses facing on it. A rather loose cement fence divided via Ponchielli from the station and the gas cloud went through it. Finally, the LPG cloud, also due to the hot night that forced people to leave their windows open, entered the ground floors and basements and accumulated up to flammable limits. According to the report of the engine drivers, no immediate ignition followed the release. It is not clear if the first ignition source was nearby the railway or among the surrounding houses (more probable), however when it occurred a fire propagated through the flammable portion of the cloud (FLASHFIRE), reached the houses and caused some deflagrations (VCE) [2].

No BLEVE occurred as the LPG cloud did not involve the other wagons and also due to the subsequent heavy cooling operations made by the firefighters.

Some witnesses reported 2 min, others 5 min, as the time elapsed between the crack opening and the first explosion. A short time later, two further explosions were heard [2].

Buildings up to 200 m from the release point were damaged due to the collapse of some of the apartments and glasses were projected over an extended area. A large-scale fire developed near the damaged rail tanker. Thirty-two people died (the last one died exactly two months after the accident); more than thirty people were seriously injured. About 1100 people were evacuated for safety reasons [3].

The national and regional fire Emergency Centers dispatched support fire teams, which came from all of the Provincial Fire Departments of Tuscany and neighbouring regions. About 300 firefighters were involved in the operations. At early dawn, all fires were extinguished and brought under control. Fire operations continued during the night and all day on June 30. Early in the morning on June 30, clean-up of the collapsed buildings debris and rescue operations for injured people were started. The firefighters removed the LPG load from the undamaged derailed tankers working 24 hours a day with no interruptions from the morning of June 30 to the evening of July 2 [3] [4].

The main cause of the accident seems to be a mechanical failure in the first LPG tanker of the train. One of the axles was found broken probably due to a fatigue crack (also under investigation).



Fig. 2

RR

The drivers felt a strong jerk on the traction; they went to the window and saw the first tank car gone off the rails. The drivers applied immediately the emergency brakes and they started to smell the gas. Before the ignition of the gas cloud, the drivers had sufficient time to shut-down the engine (e.g., lowering the pantograph), remove some documents and run about 150-200m away from the railway line. They took shelter behind a wall of the station and immediately after, the explosions and the fire occurred [2] [4].

The railway accident investigation branch of RFI (that is the state owned railway infrastructure manager) opened a technical investigation to find out the cause of the accident, in parallel and independently from the investigation aimed to identify any possible responsibilities in the lawsuit.

Consequences of the accident :

The accident caused serious damages to people and generated distress in the population.

The buildings along via Ponchielli, and the neighbouring streets were on fire, with approximately 200 metres of flames on both sides of the road. Five houses collapsed due to inner explosions. Almost all the remaining houses of via Ponchielli burned due to the subsequent fires that engulfed also other areas surrounding the station (fig. 3) [4] including trees in a small public children's park some bushes and parked cars and trucks (fig. 4) [4]. The poolfire from the liquid-phase LPG could be noticed far away with flames as high as 20-25 m [2] [3].

Fourteen people died immediately: some under the collapse of buildings or suffocated by the smoke inside their houses ; some burned because standing inside the flash area. The fatalities rose to 22 people the day of the state funerals. Finally, there were 32 fatalities (one woman had a heart attack), the last person died exactly two months after the accident. More than thirty people were seriously injured. About 1100 people had to evacuate their homes for safety reasons.



Fig. 3 RR

The overall damages for the population and the infrastructures have been preliminarily estimated to a few tens of millions euros [2].



RR Fig. 4



RR

The European scale of industrial accidents :

By applying the rating rules applicable to the 18 parameters of the scale officially adopted in February 1994 by the Member States' Competent Authority Committee for implementing the 'SEVESO II' directive on handling hazardous substances, and in light of the information available, this accident can be characterised by the four following indices:

Dangerous materials released	<input checked="" type="checkbox"/> <input checked="" type="checkbox"/> <input checked="" type="checkbox"/> <input checked="" type="checkbox"/> <input type="checkbox"/> <input type="checkbox"/>
Human and social consequences	<input checked="" type="checkbox"/> <input checked="" type="checkbox"/> <input checked="" type="checkbox"/> <input checked="" type="checkbox"/> <input checked="" type="checkbox"/> <input checked="" type="checkbox"/>
Environmental consequences	<input type="checkbox"/> <input type="checkbox"/> <input type="checkbox"/> <input type="checkbox"/> <input type="checkbox"/> <input type="checkbox"/>
Economic consequences	<input checked="" type="checkbox"/> <input checked="" type="checkbox"/> <input checked="" type="checkbox"/> <input checked="" type="checkbox"/> <input checked="" type="checkbox"/> <input checked="" type="checkbox"/>

The parameters composing these indices and their corresponding rating protocol are available from the following Website : <http://www.aria.developpement-durable.gouv.fr>

The full content of the crashed LPG tank was released and burnt. These 45 t (22.5 % of the upper-tier Seveso threshold) made the "dangerous material released" index climb up to 4.

In total, 32 people with no relation to rail freight lost their life and more than 50 were severely wounded : the human impact index raises at 6.

Finally, the total economic loss incurred to third parties stands at several tens of million €. The “economic consequences” are rated 6.

THE ORIGIN, CAUSES AND CIRCUMSTANCES SURROUNDING THE ACCIDENT

The accident is still under investigation and the trial is not concluded, so until now we can only assume on the basis of a preliminary analysis, some direct causes :

- 1) Mechanical failure of the front axle of the first wagon. The failure occurred exactly between the wheel and the axle (fig. 5) [7] probably when the train was at the entrance of the station, and the train derailed after about 700-800 m [7], then the truck (the whole complex wheels-axle) was projected at about 70-80 m away [7], and the first wagon overturned (fig. 6a). The section of the rupture looks smooth on more than 90% of the surface (fig. 6b and 6c) [4], the other part of the section appears instead coarse and corrugated. These elements seem to suggest a fatigue-type rupture [1] [4], that developed in a relatively medium - long period, and consequently raise questions about identification of the problem, control inspection procedures and adequacy of verification techniques applied: is there any evidence that this kind of rupture happened in the past ? Was a risk analysis conducted identifying this kind of failure and possible consequences? Do tanker control inspection procedures require specific attention to the system wheels - axle? What is required in terms of integrity test of that specific part? Is the kind of test required sufficient to identify the potential problems ? Is the time period between controls short enough to prevent that kind of failure? In case of transportation of dangerous substances are these controls sufficiently stressed?
- 2) Train speed at about 90 km/h: it was below speed limit set at 100 km/h [1] [2] ; however, a specific analysis could be helpful to establish if more restrictive speed limits, time of transit or any other particular additional precaution are required when dangerous substances are in transit nearby densely populated areas.
- 3) A breach, about 40cm long and 2-5 cm wide (fig. 8) [4], was produced in the first rail tanker after the derailment. The cause of the breach is still under discussion, highly suspected are either the I-shaped stakes disposed close to the railway line (fig. 7) [4], used as references to control rail stability, or the “common crossing” (or “frog”) of a rail switch [1].



Fig. 5

RR

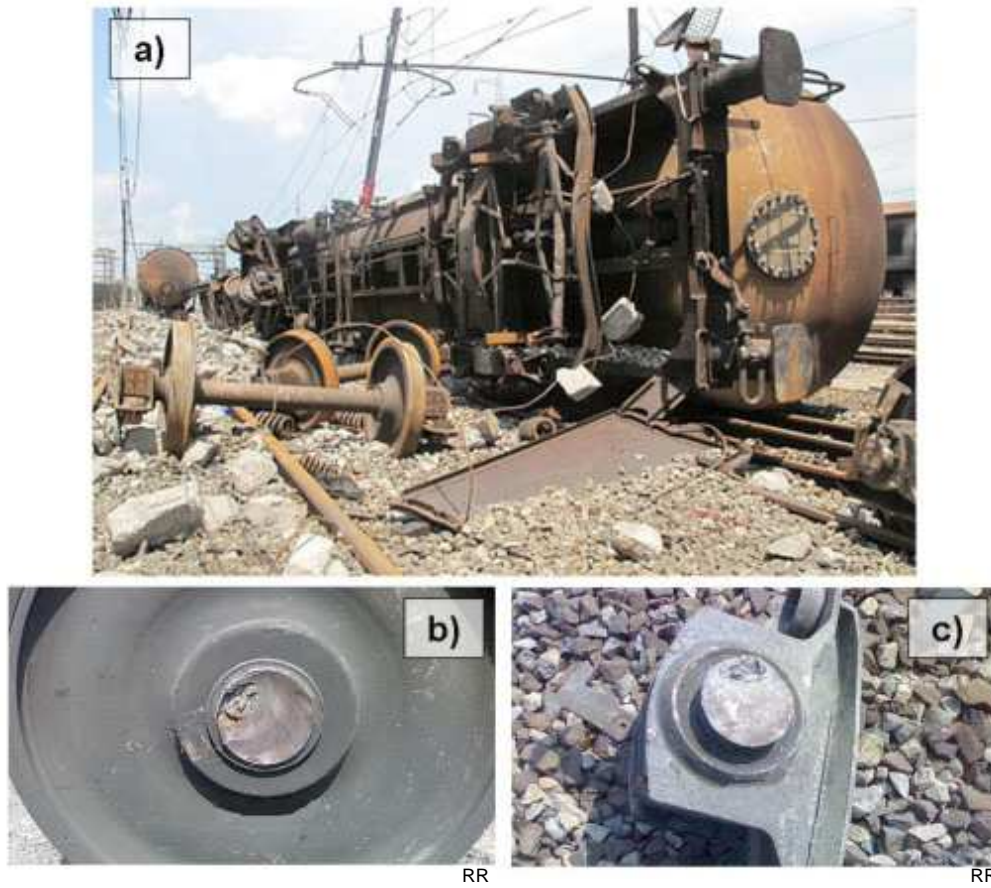

Fig. 6

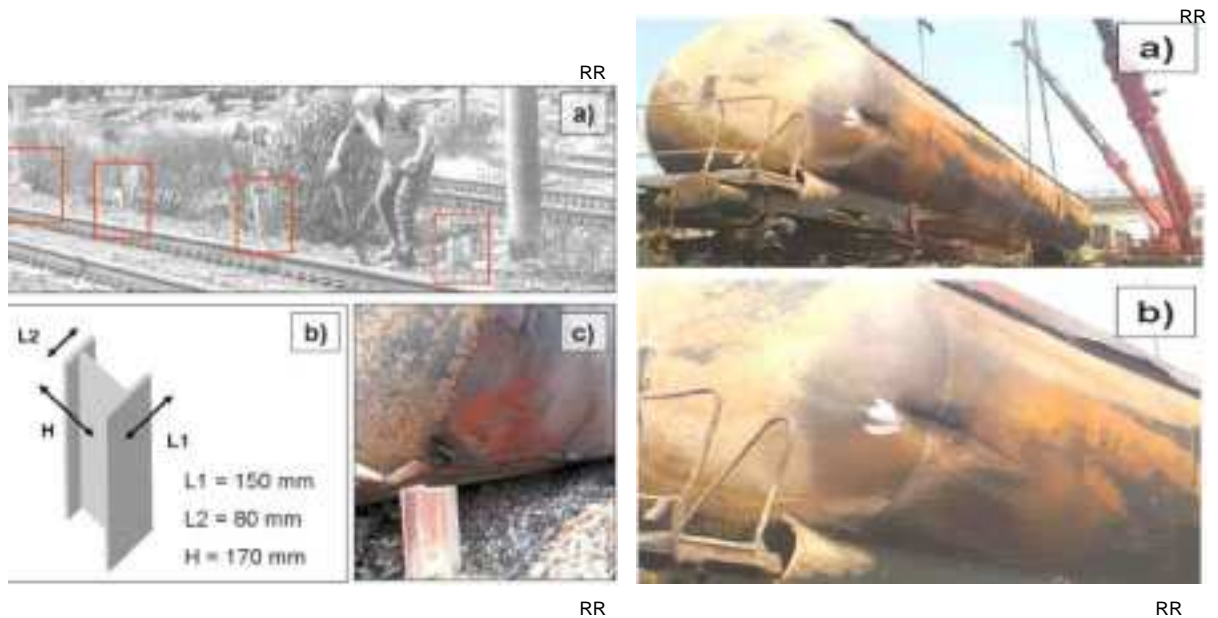

Fig. 7

Fig. 8

ACTIONS TAKEN

Emergency measures :

After the accident a joint emergency centre (COM) for rescue coordination and an advanced medical post (PMA) were set up. The national and regional fire emergency Centres dispatched support fire teams, which came from all of the Provincial Fire Departments of Tuscany and neighbouring regions. About 4 hours later, early at dawn, all fires were brought under control.

The fire teams had to face difficult scenarios. On the north side of the railway, the buildings along via Ponchielli and the neighbouring streets were on fire, with approximately 200 metres of flames on both sides of the road. The trees in a small public children's park were also burning, as well as some bushes and cars and trucks parked along the road. Making their way through the flames, the firefighters encountered people lying down who were engulfed in flames while trying to escape from the area; crews extinguished the flames and handed the injured over to the Emergency Health Services. Firefighters rescued people from burning houses, having to access some buildings through first floor bedroom windows to reach injured people and take them to safety. Besides these rescues, three buildings collapsed, and several victims were trapped under the rubble. Even wearing the complete required personal protective equipment, firefighters needed additional protective cover from their colleagues' hoses in order to endure the strong thermal radiation.

In the railway area, in order to avoid flames threatening the other intact LPG tankers, fire teams proceeded to cool the tankers closest to the one on fire. The other fires were kept under control in order to ensure a complete combustion of the gas released. Wooden sleepers were burning, as well as electrical and transmission cables, brushwood, shrubs and various other combustible materials along the railway [3] [4].

An Advanced Command Post (PCA) for the operation command was activated immediately in a safe zone close to the intervention area. All fire teams arriving on site were sent to the PCA where they received instructions for positioning and tasks to be carried out. Fire operations in via Ponchielli and along the railway line continued during the night and all day on June 30. Early in the morning on June 30, clean-up of the collapsed buildings debris was started in order to search for people trapped under the rubble, and to remove unsafe building elements.

The National Fire Emergency Centre immediately alerted and deployed the regional advanced CBRN (Chemical-Biologic-Radiological-Nuclear) units to the site in order to carry out the LPG transfer operations from derailed tankers to other tankers and allow its removal to a safe place. CBRN units from the provincial fire departments of Tuscany, as well as the Regional Advanced Unit of Tuscany, were called to the site to detect any trace of LPG gas and constantly monitor the derailed tankers. CBRN units from the provincial fire departments of Venice, Milan and Rome reached the incident site during June 30, to start preliminary operations – the setting up of special safety and gas transfer equipment and the deployment of fire teams in charge of ensuring support and assistance to operations (fig. 9) [3] [4]. From the morning of June 30 to the evening of July 2, working 24 hours a day with no interruptions, about 700 tons of LPG were transferred to a total of nine tank lorries [3] [4].



Fig. 9

RR

Official action taken :

The railway accident investigation branch of RFI has opened an investigation about the cause of the accident, in parallel with an official public inquiry. A detailed investigation is still open, and involves 349 inquired parts, 8 companies and 38 inquired persons [7]. The trial started in the beginning of 2011.

LESSONS LEARNT

The analysis below is based on information provided by ISPRA.

The Viareggio accident is the worst railway accident that ever happened in Italy related to the transportation of dangerous substances, and the most serious accident occurred in Italy involving LPG.

The analysis of the accident points out the following elements concerning lessons learnt :

- a) fatigue-type rupture of the axle, if confirmed by the conclusion of the investigation, will point out the need to reinforce the check-inspections, in particular in terms of :
 - o efficiency of the inspections-controls actually in force for the mechanical device origin of the accident (axle-wheels system) ;
 - o review of techniques and procedures for this type of mechanical device, and if needed addition of new and more specific control tests ;
 - o review of the specific requirements to be established (responsibilities, technical specifications, procedures, etc.) for regulating the case of involvement of more contractors and the use of subcontractors (in particular for maintenance activities).
- b) train speed at about 90 km/h and presence of structures (stakes/switches) along the railroad line: a specific risk assessment should have been used to assess their compatibility. A risk assessment study, in particular for transport of dangerous substances, should consider all the risk factors present along the railroad line (i.e. allowable speed of the train, presence of nearby structures, level of vulnerability and urbanization of crossed areas, etc.) and its results could consequently useful to identify, if needed, additional technical/managerial measures to adopt, for example :
 - o speed limitations to trains carrying dangerous substances when crossing populated areas ;
 - o additional safety devices like RTB installation (temperature-detectors of the truck), Derailment Detection Device (DDD) [1] ;

adoption of different types of stakes/switches in the rail (plastic or metal-alloy stakes with low mechanical resistance) or possible prohibition of them.

On the basis of the elements indicated above, even if the rail transport is excluded from the Seveso scope, it can be useful, also as an exercise, to refer to Seveso SMS elements for the analysis of the accident, especially considering that the large quantities of dangerous substances carried by the rail tankers can be of the same order as that present in the storage depots located in the industrial establishments.

The SMS faults analysis used by the Seveso inspectors in Italy was experienced on the Viareggio accident. This method makes reference to a check list of SMS elements (see Annex 1), consistent with the SMS structure given in the Annex III of Seveso Directive. The analysis aims to point out the SMS faults identified as root causes of the accidents ; in Viareggio accident the main elements available seem to highlight the following SMS faults:

- faults in identification of possible accidental events, safety analysis and residual risk; faults in planning and updating of technical and/or managerial solutions for the reduction of risks (Seveso inspectors check list elements 3.i, 3.ii, 3.iii) ;
- faults in identification of plants and equipment to be subject to inspection plans, and in maintenance procedures; faults in clear definition of maintenance activities responsibilities, and in communication of accomplishment of the maintenance-work, re-examination to assure the proper recovery of correct operational standard (elements 4.i, 4.ii, 4.iii, 4.iv, 4.v).

In conclusion, all the management faults previously identified as hypothetical critical issues causing the Viareggio accident could probably, if confirmed after the conclusion of the trial, show the need to put more emphasis on risk assessment procedures in the rail transport of dangerous substances and on consequent actions more similar to those already required for the operators subjected to the Seveso Directives. Additional efforts towards a higher level of harmonisation of the maintenance regimes existing across Europe in the European regulation for transport of dangerous substances would likely be of great value.

REFERENCES

- [1]. G.Landucci, A.Tugnoli, V.Busini, M.Derudi, R.Rota, V.Cozzani (University of Pisa and Politecnico di Milano) - The Viareggio LPG accident: lessons learnt - Journal of Loss Prevention in the Process Industries, 24 466-476. 2011
- [2]. S.Brambilla, R.Totaro, D.Manca - Simulation of the LPG release, dispersion, and explosion in the Viareggio railway accident - Presented at AIDIC/CISAP 4th International Conference on Safety & Environment in Process Industry, Florence, Italy. March 2010
- [3]. G.Romano (Official of the Italian National Fire Brigades) - Italy: train crash LPG blaze - CRISIS Response Journal, Vol. 5, Issue 4. June 2010
- [4]. G.Romano (Official of the Italian National Fire Brigades) - Viareggio, the night between June 29 and 30 2009 rail accident - VIII International Forum on Industrial Safety, Saint-Petersburg. May 2010
- [5]. B.Sannoner, M.Bresemi, C.Ortolani (Politecnico di Milano) – Sicurezza nell'impiego e nel trasporto del GPL. December 2010.
- [6]. G.Mancini – Viareggio, Esplosione del GPL fuoriuscito dalla cisterna di un convoglio ferroviario - Il giornale dell'ingegnere, n. 14. 2009
- [7]. Articles from news agencies and national and local and newspapers: Ansa.it, La Repubblica, La Nazione (2009-2011).

Annex 1: Elements of SMS Seveso inspectors check-list

1. The document on prevention policy

- 1.i Definition of prevention policy
- 1.ii Verification of the SMS structure and its integration with the establishment organization
- 1.iii Policy Document Contents

2. Organization and personnel

- 2.i Definition of responsibilities, resources and planning of activities
- 2.ii Information activity
- 2.iii Training and formation activities
- 2.iv Human factors, operator/plant interfaces

3. Evaluation and identification of major hazards

- 3.i Identification of substances and processes hazards; definition of safety requirements and criteria.
- 3.ii Identification of possible accidental events, safety analysis and residual risk
- 3.iii Planning and updating of technical and/or managerial solutions for the reduction of risks

4. Operational control

- 4.i Identification of plants and equipment to be subject to inspection plans
- 4.ii Process documentation
- 4.iii Operating procedures and instructions in normal, abnormal and emergency conditions
- 4.iv Maintenance procedures
- 4.v Materials and services procurement

5. Management of change

- 5.i Technical and organizational plant modifications
- 5.ii Documentation updating

6. Emergency planning

- 6.i Accident analysis, planning and documentation
- 6.ii Roles and responsibilities
- 6.iii Controls and verifications of the management of emergency situations
- 6.iv Alarm and communication systems and support to the external intervention

7. Monitoring performance

- 7.i Performance evaluation
- 7.ii Accident and near-accident analysis

8. Audit and review

- 8.i Safety audits
- 8.ii Review of safety policy and of Safety Management System.

Explosion of a sulphuric acid tank

4 August 2009

Gonfreville-l'Orcher

(Seine-Maritime)

France

Chemistry
 Sulphuric acid
 Hydrogen
 Explosion
 Tank
 Maintenance
 Equipment defect
 Organisation / controls

THE FACILITIES INVOLVED

The site :

This plant, rated upper-tier SEVESO, was using naphtha and butane as inputs to produce the most widespread intermediate chemical compounds in the petrochemical industry (i.e. ethylene, propylene, butadiene and benzene), for subsequent input into plastics manufacturing processes.

The unit involved :

The accident occurred on a 100-m³ capacity tank (built in 1974) containing sulphuric acid concentrated to 96%. Installed outdoors on piles above a retention basin lined with epoxy resin and part of the unit for treating sodium-bearing water, this tank was used to supply :

- the neutralisation reactor for sodium water stemming from the absorption of hydrogen sulphide on the vapour cracking unit ;
- demineralisation chains of water for boilers and cooling towers with sulphuric acid when the dedicated tank was undergoing maintenance.

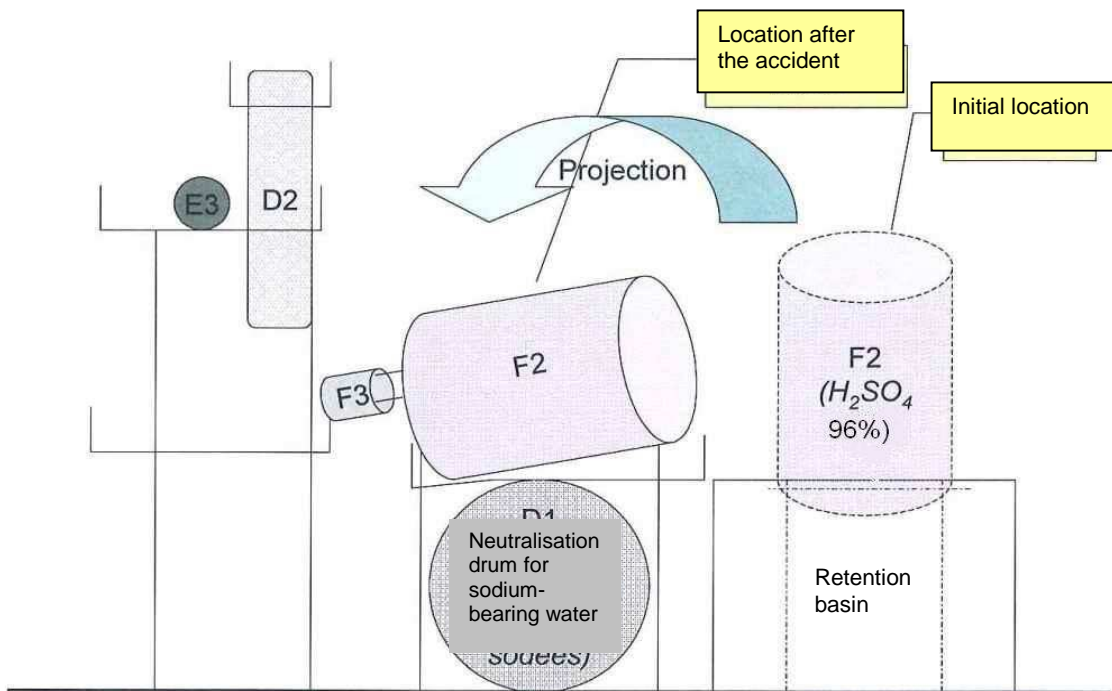

Diagram of the accident scene

This tank had already been repaired in 1989 following an incident that caused its delamination, yet without breaking any fastenings, due to a release of carbonic gas during the sulphuric acid neutralisation step (ARIA 23705). A support bracket had been added in response to this initial accident, and the cleaning procedure was also revised.

THE ACCIDENT, ITS CHRONOLOGY, EFFECTS AND CONSEQUENCES

The accident :

On 17 July 2009, a leak was detected on the F2 tank containing 70 m³ of concentrated sulphuric acid (caused by a 1-mm hole). This leak was plugged on 18 July using a temporary sealant system following approvals delivered by the onsite inspection department.

On Friday 31 July, the tank was emptied to a point of inducing pump cavitation. The remaining product was drained into the retention basin and the tank was rinsed with water over the weekend. A scaffolding was set up to accomplish the rest of the works programme.

On Monday 3 August, the rinsing water collected in the retention basin was conveyed to the water treatment plant.

On Tuesday 4 August, the task of chemical consignment (platinum plating) of the inventory was undertaken in order to isolate the storage capacity. A member of the plant staff, accompanied by 2 subcontractor employees, climbed onto the tank to open the manhole. An explosion occurred around 9:15 am when the plant technician used a grinder to shear the seized bolts.

The F2 tank, empty at the time of the accident, was suddenly lifted 2 or 3 m high and then fell back to the ground on top of a nearby drum. As it was falling, the tank brought down the scaffolding that had been installed for upcoming maintenance.

The Internal Emergency Plan was activated. The site operator notified the local Prefecture, town halls and the general public.

Consequences of this accident :

Three individuals were hurt, with two of the injuries serious.

Two subcontracted employees and a site technician were on the scaffolding at the top of the tank at the time of the explosion. One subcontractor was ejected towards a neighbouring structure 5 metres aboveground when the tank suddenly thrust upward. He landed back on the ground away from the scaffolding. The other subcontractor was pinned in the scaffolding. The third victim (plant technician) took a hard fall and was found on the ground unconscious. Ten other people were seen by the psychological response team at a treatment office opened onsite.

No environmental impact was reported and no hazardous substances released.

The damages were limited to destruction of the tank and all connecting piping; the unit was shut down. The tank was torn apart over half the shell/bottom junction circumference. Its anchorages were also ripped out.



Photos courtesy of DREAL:
Concrete base where the tank was positioned



Damaged tank

The European scale of industrial accidents

By applying the rating rules applicable to the 18 parameters of the scale officially adopted in February 1994 by the Member States' Competent Authority Committee for implementing the 'SEVESO' directive on handling hazardous substances, and in light of information available, this accident can be characterised by the four following indices:

Dangerous materials released		<input checked="" type="checkbox"/>	<input type="checkbox"/>	<input type="checkbox"/>	<input type="checkbox"/>	<input type="checkbox"/>	<input type="checkbox"/>
Human and social consequences		<input checked="" type="checkbox"/>	<input checked="" type="checkbox"/>	<input type="checkbox"/>	<input type="checkbox"/>	<input type="checkbox"/>	<input type="checkbox"/>
Environmental consequences		<input type="checkbox"/>	<input type="checkbox"/>	<input type="checkbox"/>	<input type="checkbox"/>	<input type="checkbox"/>	<input type="checkbox"/>
Economic consequences		<input checked="" type="checkbox"/>	<input checked="" type="checkbox"/>	<input checked="" type="checkbox"/>	<input type="checkbox"/>	<input type="checkbox"/>	<input type="checkbox"/>

As the accident unfolded, an explosion occurred that revealed the presence of a Seveso-listed substance, namely hydrogen. Since the quantity was estimated at 200 g, the index relative to hazardous substances released was set equal to 1 (see parameter Q1). Three injuries were reported, two of them serious, assigning the index relative to human and social consequences a "2" score (parameter H4). No environmental consequence was identified, resulting in a "0" rating for the environmental consequences index. Lastly, the cost due to property damage and operating losses was estimated at €6 M, yielding a score of "3" for the index relative to economic consequences (parameters €15 and €16).

The parameters composing these indices and their corresponding rating protocol are available from the following Website: <http://www.aria.developpement-durable.gouv.fr>.

THE ORIGIN, CAUSES AND CIRCUMSTANCES SURROUNDING THIS ACCIDENT

Insufficient rinsing of the tank (just a single rinsing cycle was performed) combined with the presence of a low concentration of sulphuric acid caused an acid attack of the metal, leading to the formation and accumulation of hydrogen at the top of the tank (dome-shaped tank roof). The explosion occurred by means of igniting the flammable mix created with air at the time of splitting the corroded bolts on the dome manhole with a grinder.

The metallurgical assessment performed on this tank indicated the presence of extensive internal corrosion over the lower part of the structure. This observation confirmed the sudden onset of corrosion at the tank sidewall due to diluted acid, thus generating a source of hydrogen production.



Photo courtesy of DREAL: The damaged tank

ACTIONS TAKEN

A lawsuit was filed against the site operator; a safety perimeter was set up around the installation on the day of the accident.

On the day following the accident, an extraordinary session of the Committee for Hygiene, Safety and Working Conditions (CHSCT) launched an investigation commission that held its first meeting on 13 August. An executive summary of the accident analysis, accompanied by a set of guidelines (see below under "Lessons learnt"), was presented at a second meeting of the full CHSCT body. This report stated the findings of a 200-g release of hydrogen and the formation of a 4 to 6-m³ flammable gas cloud, in accordance with simulations run in-house when reproducing the effects observed due to the presence of sulphuric acid at low concentrations inside the tank after failing to bleed the tank.

The sodium water treatment facility remained idle for several weeks. Following its temporary storage (which entailed a temporary authorisation, with renewal) within a bulk chemicals warehouse immediately adjacent to the site, the sodium water was conveyed as waste to authorised treatment centres.

A temporary sulphuric acid storage unit was set up to allow restarting the sodium water treatment unit.

LESSONS LEARNT

Regarding risk identification and evaluation

Iron, like the primary common metals (zinc, aluminium), is attacked by diluted acids with hydrogen release, according to the following reaction:

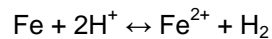

Hydrogen is a highly flammable gas (4%-75% in air) at very low levels of ignition energy (0.02 mJ, vs. 0.29 mJ for methane). The risk of a hydrogen explosion is present whenever an acid corrosion of metal has extended to a point of being observable. In certain cases, the flow of fluid against a wall (through friction) or a shock can be of sufficient magnitude to ignite.

A locally high hydrogen concentration (above 4% in air), e.g. in a dead air pocket or at the upper level of an enclosed capacity, can engender an explosion risk when undertaking works on a tank. Such an event occurred in Saint Fons (69), on 9 August, 1989 (ARIA 169), where preliminary flammability measurements conducted prior to the works phase had not enabled detecting the presence of hydrogen at the top of the tank.

The feedback available included reports of several H₂ explosions following an attack of diluted acid on steel tanks in a number of facilities: ARIA 169, 22278, 31082 (detailed accident report).

Regarding feedback management, organisation and controls

A series of recommendations were issued before placing the installation back into operation:

- Design : The new tank would be fitted with a bleed valve that was both accessible and manoeuvrable.
- Tank availability (through steps of drainage and rinsing) was improved. The completed drainage step, facilitated by tank design, was to be visually inspected by opening a manhole at a high point. This improved accessibility will serve to minimise the quantity of residual acid to just drippings at the tank bottom and on its sidewalls, in addition to enhancing not only acid neutralisation to return to a neutral pH but also tank rinsing. Moreover, this operation avoids producing diluted acid and attacking the tank.
- The method for awarding hot-work permits was improved. Feedback mainly focused on building awareness among onsite personnel of both the risks incurred and the atmospheric measurement methods to be implemented (as regards positioning of the explosimeter probe).
- The tank was to be rebuilt using carbon steel; this solution was preferred over a composite so as to streamline inspections.
- During the normal operations phase, a very minor hydrogen release into the tank remains a possibility. Measures were taken to minimise hydrogen production and prevent its accumulation by means of :
 - a vent positioned at a high point, with no internal tank structure causing evacuation of the hydrogen eventually produced during operations and preparation;
 - continuous flushing with dry air to allow hydrogen to evacuate and the tank to breathe; this feature serves to prevent moist air from entering the tank (one possible cause of corrosion).
- The classified facilities inspectorate requested that the tank be made breakable at the shell-roof junction, so that in case of an incident, the tank would remain in place and its contents not ejected.

Following this accident and several others during the same period within the chemical and petroleum industries as well as in the transport of hazardous substances via pipeline, a meeting was organised in September 2009 between the Secretary of State for Ecology and leading figures in these sectors to review the key challenges inherent in industrial safety and environmental protection. Industry leaders forwarded a series of proposals intended to improve the safety of their installations, with emphasis on strengthening controls dedicated to facility ageing and maintenance, while agreeing to pay special attention to ecologically-sensitive zones with the aim of enhancing species protection or protecting designated habitat. As part of the action plan intended to limit the risks tied to equipment ageing, launched on 13 January 2010, this resulted in the issuance of two administrative orders on 4-5 October 2010 relative to structural ageing and technological risk, making it possible to incorporate ageing concerns into the site's safety management system (SMS).



Explosion in a chlor-alkali plant due to a voltage dip

23 July 2009

Ibbenbüren
Germany

Chlorine
Electrolysis
Electric defect
Hydrogen
Explosion
Gaseous releases

THE FACILITIES INVOLVED

The site :

The accident happened in a chlor-alkali plant based on the mercury-process. The plant is located in an industrial estate which houses among others four chemical plants consuming products of the chlor-alkali-plant. Adjacent to the west there is a commercial area. The estate lies in rural setting alongside a Channel. The shortest distance from the chlor-alkali-plant to an inhabited area is about 750 m, to a school about 1100m. A farmhouse is situated at a distance of 520 m.

The annual capacity of chlorine production is 146 kt. The input salt is shipped via the channel. Chlorine is transported from the site solely by rail. All other products are transported by ship, rail or road. Besides the chlor-alkali plant there are consumers for chlorine and hydrogen on the site (synthesis of sodium hypochlorite, hydrochloric acid, metal chlorides).

The main features of a chlor-alkali plant are the cell room, the chlorine absorption unit, the brine circuit, chlorine processing, hydrogen processing, caustic processing and storage tanks for chlorine, caustic soda and hydrogen.

The involved units :

The involved units are the cell room and the standby set as causal units, and parts of the chlorine processing as damaged units.

The cell room contains the low height (a few tens of cm) and large surface (several tens of m²) cells, inside which the electrolysis takes place. A 3 mm thick layer of mercury flows on the slightly inclined bottom of the cells and acts as a cathode, on which the brine (NaCl) previously purified (removal of carbonates, sulphates, calcium, manganese ions and metals traces) runs at a speed of 1 m / s. The anodes made of titanium coated with ruthenium and titanium oxides, are arranged parallel to the surface of mercury at a distance less than 5 mm.

Chlorine gas is directly formed at the anode by redox at high temperature (T = 80°C) and in acid medium (pH = 4) to avoid chlorine disproportionation.

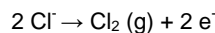

The cathode reaction is divided into two steps in order to separate chlorine and hydrogen : In the cell a sodium/mercury amalgam is formed, which is decomposed to hydrogen and caustic in a separate denuder.

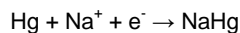

The depleted brine is recycled to the inlet of the cell after being enriched by the addition of NaCl crystals. Mercury amalgam formed by the reaction (NaHg) is pumped to the top of a vertical tank (called decomposer) filled with graphite impregnated with a transition metal (Fe or Ni) used to break it down into hydrogen, caustic soda at 50% and mercury by the addition of distilled water. The hydrogen formed is collected for use in other manufacturing processes.

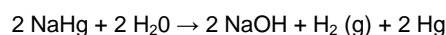

The hot and wet chlorine gas produced in the cells is fed into a collecting pipe leading from the cell room to the primary chlorine processing, which comprises wet gas cooling and low-pressure compression. These tanks are directly in front of the cell room. Further chlorine processing takes place in an adjacent building.

The 110 kV voltage of the external electricity supplier is transformed to 10 kV in a substation near the site and then led to the 10 kV station of the site. The lower voltages required are produced in a series of step down transformers and are then distributed via several conduction rails. Vital aggregates for preventing hazards are connected to the emergency

conduction rail. In case of voltage failure the stand by set is automatically started and switched to the emergency conduction rail.

Figure 1 shows the flow diagram of the mercury cell technology (excerpt from the “Chlor-Alkali” BREF, 2001)

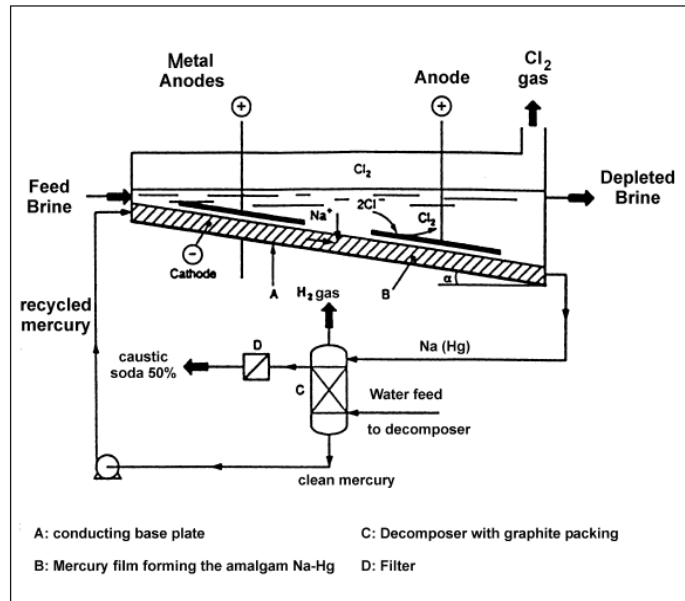

THE ACCIDENT, ITS CHRONOLOGY, EFFECTS AND CONSEQUENCES

The accident :

On 23 July 2009 a lightning strike caused a voltage dip in the external power. The chronology of the accident is shown in the following table :

01:12	Lightning in overhead line, voltage dip in internal power network (30ms - 200 ms)
01:13	Control desk: rectifiers drop out, Potentiometers to zero
01:15	Attempt to start the chlorine absorption unit via a gas blower
01:30	Alarm activation
01:38	Arrival of the on call team “electrical workshop”
01:41	Loud bang, devastations in the low-pressure system of the chlorine processing
01:45 – 02:00	Electrical workshop team puts emergency power rail into operation, decouples intact and damaged units (chlorine low-pressure/ medium-pressure)
01:45	Sprinkler system in operation, arrival of fire brigade
02:00 – 03:00	Measurements of the fire brigade in the surrounding and at site. As a precaution, construction of a water shield
03:00 – 05.00	Removal of chlorine from the different parts via absorption unit, shut down of plant

Consequences of the accident :

The whole low-pressure system of the chlorine processing was destroyed. The photos below show the damage to the chlorine-collecting pipe below the cell room and to two cooling towers and a demister.

Up to 500 kg of chlorine gas were released in the course of the accident. A small portion was released due to the failure of the chlorine absorption unit after 1:12, but most of the gas was released after the explosion via the ruptured tanks.

The spread of the gas was hindered by the sprinkler system and the water shield.

Chlorine concentration measured by the fire brigade ranged between 0,1 and 1,5 ppm. The AEGL-1⁽¹⁾ level for 30 minutes had been exceeded at two measuring locations; the AEGL-2⁽²⁾ level for 30 minutes was not exceeded.

One member of the staff inhaled chlorine for a short time; one member was injured in the leg and hospitalised less than 24 h.



RR

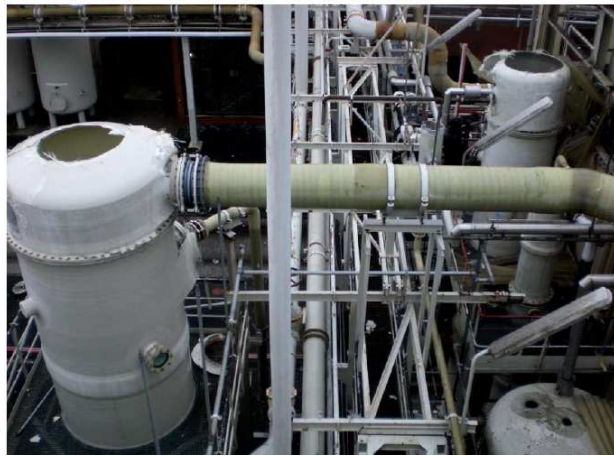

RR

⁽¹⁾ airborne concentration above which US EPA predicts that the general population could experience notable discomfort, irritation, or certain asymptomatic nonsensory effects, however, the effects are not disabling and are transient and reversible upon cessation of exposure

⁽²⁾ airborne concentration above which the general population, including susceptible individuals, could experience irreversible or other serious, long-lasting adverse health effects or an impaired ability to escape

The European scale of industrial accidents

By applying the rating rules applicable to the 18 parameters of the scale officially adopted in February 1994 by the Member States' Competent Authority Committee for implementing the 'SEVESO II' directive on handling hazardous substances, and in light of the information available, this accident can be characterised by the four following indices:

Dangerous materials released		<input checked="" type="checkbox"/>	<input checked="" type="checkbox"/>	<input checked="" type="checkbox"/>	<input type="checkbox"/>	<input type="checkbox"/>	<input type="checkbox"/>
Human and social consequences		<input checked="" type="checkbox"/>	<input type="checkbox"/>	<input type="checkbox"/>	<input type="checkbox"/>	<input type="checkbox"/>	<input type="checkbox"/>
Environmental consequences		<input type="checkbox"/>	<input type="checkbox"/>	<input type="checkbox"/>	<input type="checkbox"/>	<input type="checkbox"/>	<input type="checkbox"/>
Economic consequences		<input checked="" type="checkbox"/>	<input type="checkbox"/>	<input type="checkbox"/>	<input type="checkbox"/>	<input type="checkbox"/>	<input type="checkbox"/>

The parameters composing these indices and their corresponding rating protocol are available from the following Website : <http://www.aria.developpement-durable.gouv.fr>.

The amount of chlorine released was about 500 kg. The SEVESO threshold (upper tier) being equal to 25.000 kg, the amount released corresponds to 2 % of the threshold. The scale for the category "dangerous materials released" is 3.

The scale of the category "human and social consequences" is 1, because of two slightly injured employees.

There were no environmental consequences according to the criteria of the European scale of industrial accidents.

The property damage resulting from the accident in the plant resulted to approximately 237.000 €. Production losses lasted for 5 weeks. The scale for the category economic consequences is estimated to 1.

THE ORIGIN, CAUSES AND CIRCUMSTANCES SURROUNDING THE ACCIDENT

The major accident prevention policy with regard to power failure is based on the emergency power supply of the units necessary to prevent hazards. These units are especially the mercury pumps and the chlorine absorption unit. The electrolyzers are expected to be out of operation during power failure.

The principle of the emergency power supply is shown in the following current network.

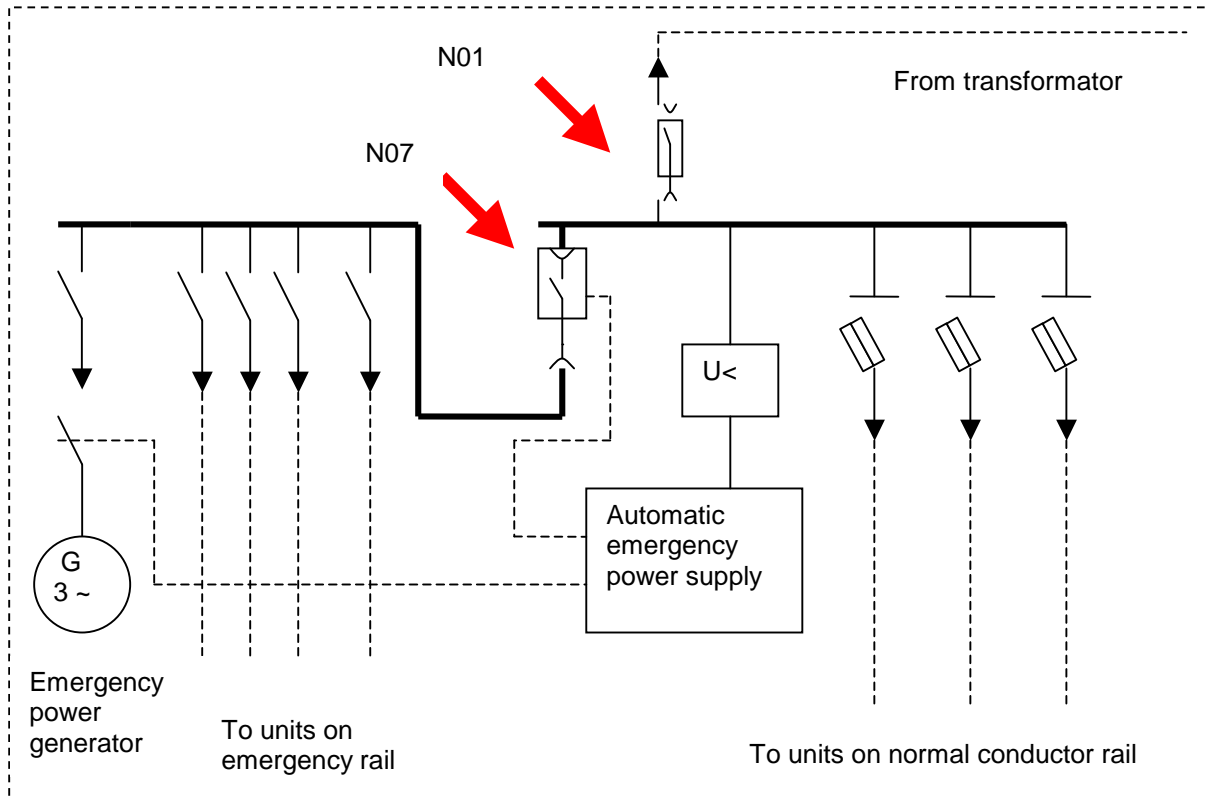

During normal operation the emergency conductor rail is supported by the internal power distribution, the switches N01 and N07 are closed. If the network monitoring registers a voltage dip and classifies the dip as failure, the N07 will open and the emergency power generator is started. On matching the connection conditions, the emergency power generator connects to the emergency conductor rail and supports the units with power.

After return of the power, there is an automatic synchronized changeover to the normal power supply. The automatic control synchronizes the emergency power supply with the internal net, closes N07 and switches off the generator.

This automation had worked for years, for example during a voltage failure on 21 July 2009.

On 23 July 2009, this happened: the voltage dip was registered by the network monitoring, the switch N07 was opened and the generator was started. But the emergency power generator was not connected to the emergency conductor rail, as the internal net had already returned. The opened switch N07 could not be closed, as the contradictory commands caused a blockade. The whole emergency conductor rail had no power, while the internal net was available.

The reaction of aggregates to voltage dips depend on different aspects as the size of the electric drive, discharge voltage, remanence and device specifications.

In this event, the medium-pressure compressor failed, while the low-pressure compressor remained operating.

Due to the failure of the medium-pressure compressor, the intensity for the electrolysis was automatically lowered to 6 kA.

The failure of the mercury pumps caused a break of the mercury surface covering the steel bottom of the cell, which is connected to the negative pole of the direct current. As a result, hydrogen was directly formed in the cell at the bare steel cathode. It was drawn together with the chlorine gas into the collecting pipe to the chlorine-processing unit, where it exploded in the low-pressure system of the chlorine processing.

The situation was complicated by the fact that some monitoring devices, which were not yet switched to uninterruptible power supply but were still connected to the emergency conductor rail, failed. These were measuring devices for hydrogen in the chlorine absorption unit, and for the Chlorine concentration after the absorption unit.

In addition, the 6 kA circuit was not monitored by the potentiometer. As a consequence, the operator could not get a complete and confirmed overview of the plant status. This is the reason, why a dangerous chlorine/hydrogen mixture could build up in the chlorine processing system for about 30 minutes. The probable sources of ignition were either an electrical sparking or electrical discharge in the cells or a spontaneous decomposition reaction due to the steam injector in the collecting pipe. After the first explosion in the collecting pipe, air was drawn in the low-pressure system by the compressor and caused subsequent deflagration and detonation.

A similar accident occurred in France in 1995 under comparable circumstances (electrical overload of a transformer, ARIA 22101). Other explosions due to an accumulation of hydrogen in the collection system of chlorine in Norway, Sweden, The Netherlands and France (ARIA 6442, 6443, 6444 and 10316) also highlight a lack of means for detecting hydrogen in the collected and processed chlorine (ARIA 14987).

ACTIONS TAKEN

An expert survey report was commissioned to clarify the facts leading to the accident and to derive the necessary actions to prevent such accidents in the future. This whole paper is based mainly on the expert survey report. The main recommendations were :

1. Optimisation of the control technology for the emergency supply in order to exclude blockades.
2. Design of the emergency power supply insuring a safety integrity level (SIL) 2 according to EN IEC 61508/61511.
 - Alternative 1: a redundant stand by set with a monitoring device in SIL 2 quality
 - Alternative 2: abandonment of emergency power supply in the safety policyActions taken: the design of the emergency power supply in SIL 2 quality was not realizable. Instead, the redundant stand by set was implemented. Additionally the lack of emergency power supply is regularly regarded in the risk analysis.
3. Alarm of the failure of the emergency power supply and the mercury pumps in SIL 2, emergency shutdown in SIL 2
4. Visualization of the switching status of the power supply, completion of connecting control devices to uninterruptible power supply
5. Instructions for operating in exceptional situations

The implementation of the recommendations is surveyed by the competent authority.

LESSONS LEARNT

According to the expert, there may well be comparable power supply systems in other plants. He reckons the technical expertise concerning the power supply system drawn from this accident of general importance. The most important lesson we have learnt is that power failure should not be considered a binary event (voltage/ no voltage) in hazard and risk assessment studies. The consequences of very short voltage dips (30 ms – 200 ms) have to be considered likewise. When hazards due to power failure are possible, the emergency power supply should be designed in a quality ensuring a safety integrity level (SIL) 2 according to EN IEC 61508/61511. Alternatively the option of emergency power supply may be abandoned in the safety policy, requiring the appropriate risk analysis and plant design.

Action 4 gives evidence to the immanent problems when gradually improving existing plants. In this case, the switching cupboard for the monitoring devices had not yet shifted from the original emergency conductor rail to the uninterruptible power supply.

The recommendation 5 emphasizes the necessity of training operators for exceptional situations. To achieve this aim, two strategies were discussed. The expert recommended additional instructions. The company emphasizes on the training of detailed understanding with the argument, that no instruction could comprise all possible hazards.

Rupture of a pipeline within an underground hydrocarbon storage facility in saline cavities

1st May 2010

Manosque (Alpes-de-Haute-Provence)
France

Releases
Pipe network / pipeline
Hydrocarbons / naphtha
Corrosion
Pollution clean-up
Offset retention

THE FACILITIES INVOLVED

The site :

The event at the origin of this accident involves a storage site devoted to petroleum products in saline cavities located within the towns of Manosque and Dauphin, right in the heart of the Lubéron Natural Park. These installations were connected with the main petrochemical plants of Fos-Berre and Lavéra by a network of pipelines.

Characteristics of the installations :

Since 1969, 7.5 million m³ of petroleum products, including 350,000 m³ of naphtha*, were capable of being stored in 26 large cavities 300 to 400 m high excavated into geological strata within salt formations.

These installations were not subjected to the regulations applicable to classified facilities, but instead to the Mining Code and SEVESO Directive.



Geographic location of the site and the area's primary watercourses (all rights reserved)

* Raw material used by chemical plants in the synthesis of plastics.
Naphtha, which is a highly volatile product, carries risks of ignition and explosion when placed in contact with air.

The site's subwatershed converges towards a single outfall. A retention basin (R1008) was set up to recover hydrocarbons or brine in case of an incident. This retention basin was equipped with hydrocarbon and salinity detectors.

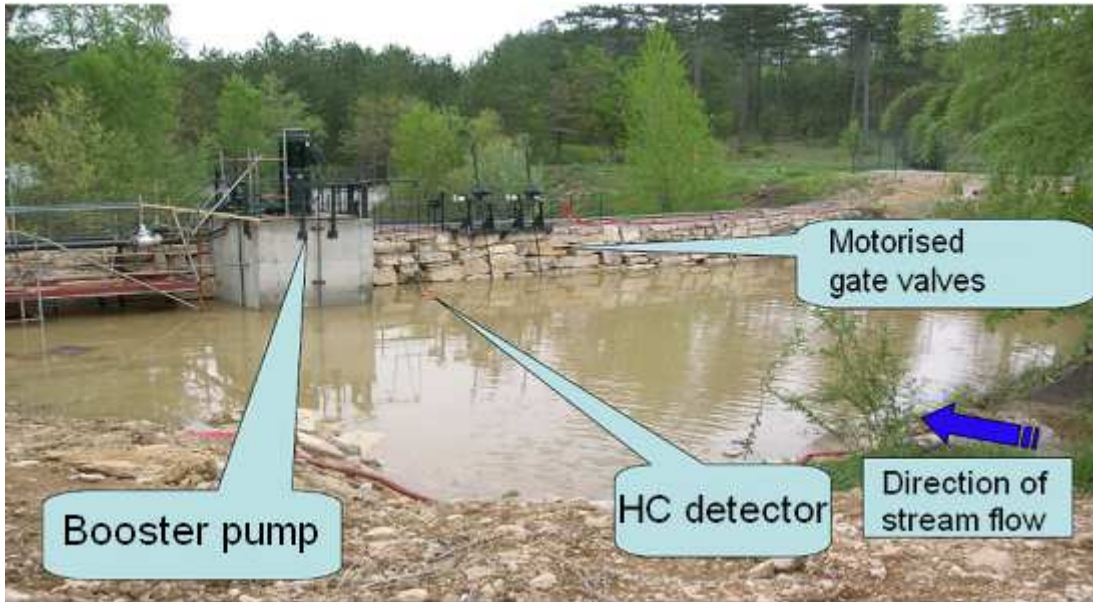

Retention basin R1008 - with an upstream cell (all rights reserved)

The infrastructure involved :

The infrastructure was an underground section of pipeline connecting a pumping station to a saline cavity (denoted ER 151 on the drawing), featuring the following primary characteristics :

- Diameter (DN): 500 mm ;
- Maximum service pressure: 66 bar ;
- Pressure at the time of the accident: 62 bar ;
- Underground depth: 2 m ;
- Component material: Steel (type: API 5L X42) ;
- Nominal tube thickness: 7 mm ;
- Product being transported at the time of the accident: naphtha, whose flash point is on the order of 41°C. The Lower Flammable Limit is 0.6% to 0.8%, while the Upper Flammable Limit is 6%-7%. Moreover, the vapour pressure equals 0.3 kPa at 20°C.

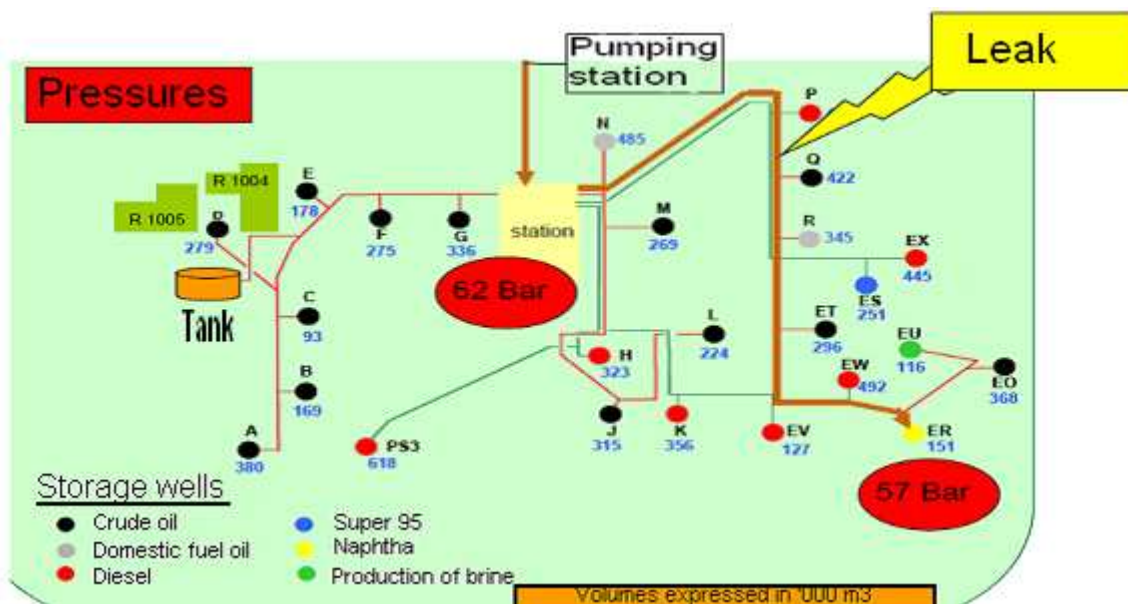

Installation layout and leak location (all rights reserved)

This pipeline was tested at 110% of its maximum service pressure in 2003. A regularly-monitored cathodic protection system was implemented to ensure its corrosion resistance.

THE ACCIDENT, ITS CHRONOLOGY, EFFECTS AND CONSEQUENCES

Chronology of events :

1st May :

7:20 pm : Rupture of the pipeline transporting the naphtha.

A loud noise followed by a sudden pressure drop was observed at the level of the pumping station.

7:23 pm : The shift foreman stopped the ongoing naphtha injection process.

7:25 pm : Notification was sent to the on-call security detail.

7:30 pm : The Internal Emergency Plan was activated.

7:43 pm : The leak was located; naphtha was flowing on the road and into the stream for ultimate discharge at the outlet.



All rights reserved

7:45 pm : End of the closing period of the motorised gate valves from the 5,000-m³ retention basin (R1008), i.e. 25 minutes after the pipeline break.

The hydrocarbon detection alarms on the retention basin were triggered.

The presence of naphtha was observed in one of the cells upstream of the basin.

Access to the site was blocked subsequent to explosibility measurements.

8:30 pm : The local fire department was called.

8:50 pm : The presence of naphtha downstream of retention basin R1008, combined with the construction of absorption dams on the AUSSELET River. A call was placed to the Prefecture as well as to the agency policing the mines.

9:00 pm : Arrival of fire-fighters at the scene.

9:48 pm : An onsite visit by the Deputy Prefect.

10:05 pm : Presence of naphtha in the "Patte d'Oie" hamlet(*) 2 km downstream of retention basin R1008, which was located in the vicinity of residential dwellings.

The Prefecture initiated the External Emergency Plan; 75 fire-fighters were deployed, along with a chemical emergency squad, a specialised pollution cleanup unit and some 20 gendarme officers.

10:14 pm : A call was made to the administrative agencies responsible for dealing with health issues, given the fact that drinking water extraction zones had been set up in neighbouring municipalities.

10:20 pm : Following the runaway of a vehicle engine that penetrated into the flammable gas cloud at "Patte d'Oie"(*), all parties involved were reminded of the strict necessity to respect the (1-km) safety perimeter.

Absorption dams were installed at "Patte d'Oie".

10:30 pm : The request was filed to set up a dam on the CD5 local road and evacuate the first group of dwellings.

10:50 pm : Request filed to install a foam blanket (400 litres of emulsifier to be poured onto the R1008 basin surface).

(*) See map on p.1.

10:52 pm : Assessment of the behaviour of naphtha, issued by the Fire Department Chief : "Heavy vapours, absence of wind, relatively low outside temperature. The naphtha vapours for the most part remained confined to the streambed."

11:00 pm : Evacuation of the villages of Dauphin(*) and St Maime(*); 15 people assigned from 5 gendarmerie brigades, along with 70 fire-fighters, were dispatched for this mission.

11:32 pm : The foam blanket was poured onto the retention basin.

The placement of additional dams on the LARGUE River(*) was targeted at its confluence with the DURANCE(*).

Explosibility measurements were being constantly taken from the R1008 basin extending to the LARGUE(*).

2nd May :

12:20 am: Use of mobile pumping facilities, then stationary pumps in order to recover naphtha from within the basin. A specialised subcontractor wound up pumping 150 m³ of naphtha.

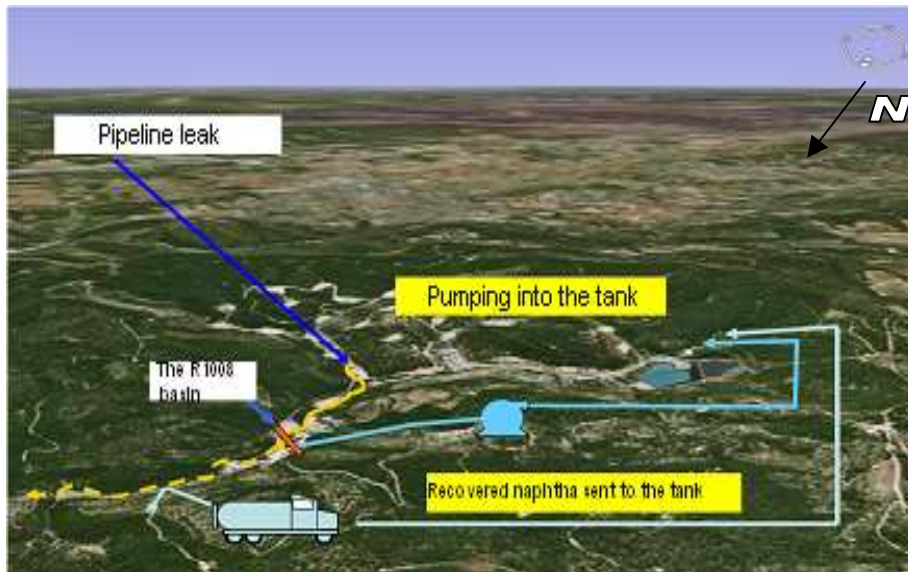

All rights reserved

3:00 am : After another campaign of explosibility measurements at "Patte d'Oie"(*), the rescue team installed a water curtain.

3:45 am : Local residents were allowed back to their homes (except for 5 dwellings).

4:00 am : The majority of residents had returned home, yet water extraction in 3 municipalities was suspended.

6:00 am : The response teams onsite were replaced by fresh personnel.



Water curtain - all rights reserved

10:35 am : The Lower Flammability Limit recorded a 0% reading both in the R1008 basin and at "Patte d'Oie"(*).

1:15 pm : Interviews were given with television stations (France 3 and M6).

2:30 pm : In conjunction with the mining police agency, recommended measures were determined (preconditions for resuming operations and environmental measures).

4:00 pm : Information was communicated to residents of Dauphin(*) and St Maime(*). A 0% Lower Flammability Limit was recorded at all measured points.

6:30 pm : The External Emergency Plan was lifted.

(*) See map on p.1.

Consequences of this accident :

This accident generated a range of consequences, including :

Hazardous substances released :

An estimated volume of 400 m³ of naphtha flowed out through the pipeline opening towards the 5,000-m³ capacity retention basin situated several hundred metres downstream, on a section with a 20-m elevation difference. 200 m³ of product escaped from this basin via 2 gate valves that had been left open for over 25 minutes. The quantity of naphtha evaporated during the accident is not known. The cloud shape had never been modelled.

Human and social consequences :

During the personnel evacuation step, the site caretaker felt faint and had to be taken to hospital. While rescue teams were onsite, 2 fire-fighters were overcome by naphtha fumes and had to be placed on oxygen. A 1-km safety perimeter was introduced, and 282 residents from 2 different towns were evacuated at around 5 am. Upon returning to their homes, local residents were prohibited from using tap water upon the recommendation of authorities. Since the water supply was not sufficient to meet the needs of residents, 168 cases of bottled water were purchased and distributed by the town hall of Dauphin. For the other municipalities, water supply wells were inspected; no pollution however was noted.

Environmental consequences :

Impacts on both flora and fauna within exceptional protected habitats were observed: dead mammals, amphibians and invertebrates.



Fatal impacts on toads and foxes (all rights reserved)

Naphtha flowed over a 5-km distance along both the AUSSELET and LARGUE Rivers. At the spot where the leak occurred, 1,500 m² of ground were polluted over depths ranging from 3 to 4 m.

Economic consequences :

The site operator allocated €7 million towards modifying and inspecting the pipe network (covering more than 8 km).

The European scale of industrial accidents

By applying the rating rules applicable to the 18 parameters of the scale officially adopted in February 1994 by the Member States' Competent Authority Committee for implementing the 'SEVESO' directive on handling hazardous substances, and in light of information available, this accident can be characterised by the four following indices:

Dangerous materials released	 <input checked="" type="checkbox"/> <input checked="" type="checkbox"/> <input checked="" type="checkbox"/> <input type="checkbox"/> <input type="checkbox"/> <input type="checkbox"/>
Human and social consequences	 <input checked="" type="checkbox"/> <input checked="" type="checkbox"/> <input checked="" type="checkbox"/> <input type="checkbox"/> <input type="checkbox"/> <input type="checkbox"/>
Environmental consequences	 <input checked="" type="checkbox"/> <input checked="" type="checkbox"/> <input checked="" type="checkbox"/> <input type="checkbox"/> <input type="checkbox"/> <input type="checkbox"/>
Economic consequences	 <input type="checkbox"/> <input type="checkbox"/> <input type="checkbox"/> <input type="checkbox"/> <input type="checkbox"/> <input type="checkbox"/>

The parameters composing these indices and their corresponding rating protocol are available from the following Website : <http://www.aria.developpement-durable.gouv.fr>.

The "hazardous substances released" index was scored a "3" as a result of the 400 m³ of naphtha that spilled out subsequent to the pipeline rupture.

The "human and social consequences" index was assigned a "3" for causing the evacuation of 282 residents for a period lasting more than 5 hours.

The "environmental consequences" index was set equal to "3" due to the extensive flow of product over a 5-km distance along the AUSSELET and LARGUE Rivers.

The "economic consequences" index could not be rated given the lack of any information relative to this indicator.

THE ORIGIN, CAUSES AND CIRCUMSTANCES SURROUNDING THIS ACCIDENT

The pipeline was excavated. A break was observed over a 3-m length at the level of the lower generatrix line at the 6 o'clock position:

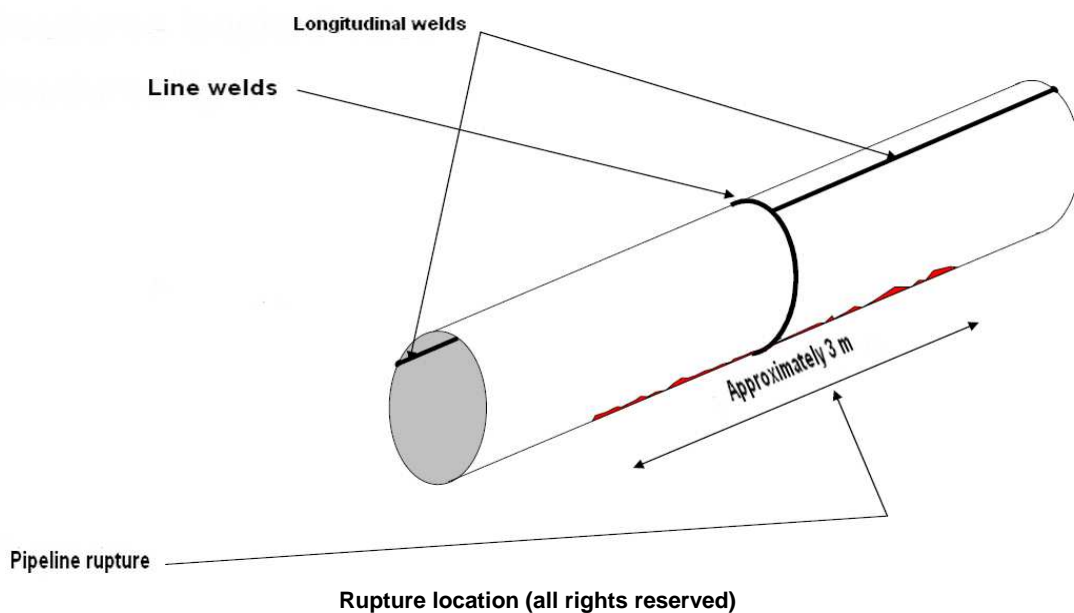

Damaged part (DREAL PACA)

Following an expert appraisal, a laboratory concluded in June 2010 that the rupture was caused by pitting corrosion that had developed underneath a hardened deposit at the tube bottom.

The positioning of this corroded zone, aligned with the lower generatrix, would have been correlated with the circulation of saltwater, which is denser than naphtha within the pipe.

The hard deposit was composed of a mix of hydroxide and iron oxide, and included traces on the surface of: oxygen, sulphur, and chlorine. The chlorine, present in the form of chloride, contributed to the loss of pipe wall thickness by means of a corrosion mechanism involving differential aeration.

This loss of thickness on the lower generatrix created a zone of less mechanical strength, which in turn facilitated the line's rupture, in propagating its tear over a length exceeding 3 m.

Non-destructive controls (NDC) were performed on selected points of the pipeline section in order to localise other critical zones over the larger segment; no loss of thickness was observed elsewhere. Tests conducted to determine the mechanical characteristics of the tube's component steel revealed no anomaly.

ACTIONS TAKEN

Measures adopted following the event :

The operator devised an initial series of corrective measures on the retention basin (R1008), in addition to focusing on the site's pipeline network. The External Emergency Plan was modified for the purpose of incorporating feedback from the May 1st event.

Retention basin :

Several measures were introduced:

- Reconfiguration of the R1008 retention basin and installation of new automated mechanisms: motorised gate valves with remote controls and control room relays, servo-control of these devices to pressure drop detectors;
- Verification of the state of repair and seal of these valves;
- Improvement of upstream (early) detection and increased number of hydrocarbon detectors.

Pipelines :

Following the accident and in compliance with a Prefectural order, the mine police requested the operator to lower the service pressure of all pipelines throughout the site.

As a result, the operating pressure dropped from 65 bar to 45 bar.

The pipeline section isolation devices to be used in the event of a leak were also modified.

Environmental impact monitoring :

In August 2010, a consultant performed a diagnostic assessment of site soil quality based on a campaign of several samples of :

- water and sediments on various streams and watercourses,
- soils at various depths.

The results of this assessment revealed soil pollution at the level of the leak with high concentrations of benzene, toluene and volatile hydrocarbons. Since these compounds are biodegradable, the consultant proposed a number of *in situ* solutions to treat the soil and water table. The relevance of these potential solutions was examined by the inspectorate to determine the remediation works required, pollution cleanup targets as well as the execution schedule.

Regarding impacts on flora and fauna, a specialised laboratory confirmed in a report dated 30 November 2010 that a severe impact had occurred in the aquatic environment, though the consultant had the impression that flora and fauna tended to re-establish their populations rather quickly despite the deteriorated habitat.

Moreover, it did not appear necessary to scour the AUSSELET River, as the flora and fauna were observed to return to normal conditions shortly thereafter.

These conclusions were entirely consistent with the prospection reports produced by other consultants in June and October 2010.

Monitoring of service provision for the site's pipeline network :

The operator studied the technical feasibility of running an instrumented scraper through its pipe network. The focus of such a strategy was to verify the possibility of modifying the current pipe alignment in order to operate an instrumented tool capable of performing a thorough inspection of pipe conditions.

Towards this end, the operator submitted to the inspectorate in November 2010 a report whose provisional conclusions offered several contributions, namely :

- Scraping and inspection of collection pipelines by means of an instrumented piston of various sections at the Manosque site was feasible.

- The entire series of preliminary modifications necessitated a works schedule on the order of 10 months prior to initiating the inspection phase using an instrumented piston.
- The phase of scraping and inspection carried with it a timetable that could not be compressed to less than 3 months, as evaluated without taking into account either the availability of supplier(s) for this specific phase or the operating constraints.

The cost of the corresponding operations has been estimated at over €7 million.

A Prefectural decree adopted in June 23, 2011 assigned the calendar of tasks and measures to be implemented in order to both manage additional pipeline risks and define the site retention system. This decree also specifies the protocols for cleaning up polluted ground as well as for restoring ecological monitoring of the zone affected by the accident.

LESSONS LEARNT

Following this event, the operator provided an assessment of the main positive features and areas requiring improvement. Among the positives, the effective response of the crisis unit was cited in addition to the constructive relationship developed with the agency responsible for policing the mines.

Regarding areas slated for improvement, the operator indicated the need to be prepared with :

- individual protective gear in adequate supply (cartridge respirators) ;
- a stock of explosimeters, flashlights and radios that meet ATEX Directive specifications, as well as disposable work outfits ;
- resources on hand for constructing road dams ;
- a reserve of non-perishable food and water onsite ;
- a fleet of vehicles capable of making emergency stops and equipped with a fire control pan.

Generally speaking, accident statistics indicate that human intervention on leaks fed by a flammable liquid may be quite hazardous. An adequate safety perimeter must be quickly established around the leak zone. In the case of this accident, the perimeter was spread over a 1-km radius circle. Naphtha vapours are capable of forming explosive mixes when in contact with air or cause fires by accumulating electrostatic charges (Klinkenberg experiment); consequently, it is recommended to limit the product's evaporation surface area to the greatest extent possible.

In Manosque, several techniques were used :

- construction of floating dams and use of haystacks on watercourses to limit the naphtha flow ;
- installation of a foam blanket on the retention basin to reduce the rate of product vaporization ;
- a 1-km safety perimeter in order to mitigate ignition sources.

Explosibility measurements and hotspot prevention deserve considerable attention and precautions, as a simple cell phone or piece of camera equipment is capable of triggering combustion. Pockets of flammable gas can arise within confined spaces, and explosibility measurements must be conducted in such spaces without underestimating the risk of explosion.

The emergency plan serves as a benchmark used for the various actors during emergency situations. This plan includes the intervention procedures previously agreed upon between the operator, fire-fighters and gendarmerie or police that clearly define the roles and protocols for each actor's intervention : valve shutoff, safety perimeter designation, assistance provided the population, and confinement phase management.

Beyond the existence of a regularly-tested emergency plan adapted to the various types of fluid transported through the pipeline, emergency response management relies on effective coordination between the intervention services involved (i.e. police, gendarmerie, fire-fighters) and the operators. Relief for victims, installation of a command and control centre shared among all services, adjustment of the safety perimeter and communications management constitute the key elements of any such plan.

Other accidents involving transport pipelines :

ARIA 168: Accident at Rosteig (France), on 28 July 1989,

ARIA 35176: Accident at Appomattox in Virginia (United States), on 14 September 2008,

ARIA 36654: Accident at La Plaine de la Crau (France), on 18 August 2009...

Hazardous substance release following inadequate HAZOP studies

21 September 2010

Heilbronn
Germany

Hazardous releases
Risk assessment
Human factor
Design

THE FACILITIES INVOLVED

The facility :

The company is a manufacturer of additives for the paper and leather industry. It is located in the industrial area of the town, with a number of other companies in close proximity. The site has been occupied by the company since 1947 with modifications and extensions over the years. The chemical operations are carried out in multi-purpose batch reactors.

The unit involved :



The unit involved in the accident was a multi-purpose batch reactor fitted with glass reflux condensers, a bursting disc of nominal bursting pressure of 0.8 bar overpressure. Operation of the reactor is a mix of manual and process controlled operations.

The reactor was connected to a water tank of capacity 32 l by a pipe. In the pipe there were two valves. The valve at the lower level was manually operated, the valve at the higher level was normally open and designed to be shut automatically on activation of the overpressure alarm at 0.5 bar. The manually operated valve was supposed to be closed before starting the hydrolysis reaction.

RR

Fig. 1: A view of the reactor after the incident

THE ACCIDENT, ITS CHRONOLOGY, EFFECTS AND CONSEQUENCES

The accident :

A failure in the addition of water to a reactor (30 litre added at once instead of in 3 litre aliquots) led to an exothermic runaway reaction. The foaming contents of the reactor broke the glass condenser and led to the release of HCl vapour (ca. 60 kg) to the atmosphere.

Against the intended operation, the manually operated valve was open, which meant that when the process was started and the process controlled valve opened the entire contents of the 30 l tank ran straight into the reactor. Although the overpressure alarm (0.5 bar) was triggered, this was too late to prevent any flow into the reactor.

The release of the HCl cloud inside the reactor building triggered the fire alarms and notified the fire brigade. An employee switched the building ventilation on which led to the spreading of the HCL vapour outside of the building and affecting the surrounding area.

Consequences of the accident :

Seven people outside of the establishment required medical attention, two of them were kept overnight in hospital. Damage to the equipment was limited to the broken glass condensers and large scale contamination of equipment and the outside of the reactor with the reactor contents.

The European scale of industrial accidents :

By applying the rating rules applicable to the 18 parameters of the scale officially adopted in February 1994 by the Member States' Competent Authority Committee for implementing the 'SEVESO II' Directive on handling hazardous substances, and in light of the information available, this accident can be characterised by the four following indices :

Hazardous materials released		<input type="checkbox"/>	<input type="checkbox"/>	<input type="checkbox"/>	<input type="checkbox"/>	<input type="checkbox"/>	<input type="checkbox"/>
Human and social consequences		<input checked="" type="checkbox"/>	<input checked="" type="checkbox"/>	<input checked="" type="checkbox"/>	<input type="checkbox"/>	<input type="checkbox"/>	<input type="checkbox"/>
Environmental consequences		<input type="checkbox"/>	<input type="checkbox"/>	<input type="checkbox"/>	<input type="checkbox"/>	<input type="checkbox"/>	<input type="checkbox"/>
Economic consequences		<input type="checkbox"/>	<input type="checkbox"/>	<input type="checkbox"/>	<input type="checkbox"/>	<input type="checkbox"/>	<input type="checkbox"/>

The parameters composing these indices and their corresponding rating protocol are available from the following Website : <http://www.aria.developpement-durable.gouv.fr>

The "Hazardous Materials Released" index was not rated given the nature of the substance released (HCl does not belong to the Seveso list).

The "Human and Social Consequences" index was rated a "3" due to the injuries sustained by 7 people outside the establishment, including 2 overnight hospitalisation.

The "Environmental Consequences" index was not rated given the absence of any impacts on the environment.

The "Economic Consequences" index was not rated given the economic damages lower than 100 k€ (30 k€).

THE ORIGIN, CAUSES AND CIRCUMSTANCES SURROUNDING THE ACCIDENT

The reaction was the hydrolysis step in a multi step process carried out in the same reactor.

The first step was the reaction of an organic phosphate ester chloride with a fatty alcohol. In the following step water is added, liberating HCl (see below) - this is the step which failed. Finally, the hydroxyl groups were to be reacted with NaOH, liberating water.

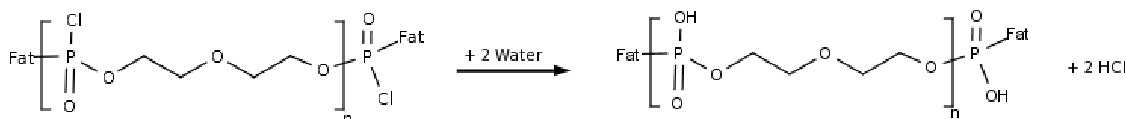

Fig. 2 : The hydrolysis step, which liberates HCl, and was the process step which failed

Within the company's Safety Management System the reactions had been assessed using the HAZOP (Hazard and Operability) method to identify the hazards and the potential consequences of deviations from the intended operation.

The HAZOP had identified the hazard potential of adding too much water as loss of control of the reaction, but only indicated that the standard operating procedures (SOP) should be improved. Standard operating procedures are not suitable for controlling the potential loss of control of a reaction. In this case only an inherently safe design through which the addition of maximum 3 litre aliquots to the reactor at one time was possible could have prevented the accident under manual control.

Other methods for handling "runaway-reactions" which are dependent on process control systems would only be able to react once the water had been added and the pressure had risen to a critical level. Pressure relief systems for foaming contents require detailed knowledge to be able to design them. The best approach is to ensure that the reaction "runaway" cannot occur in the first place.

An inspection of the plant revealed that the design of the apparatus did not deal with the human factor aspects of operating the reactor adequately. The 30 litre water tank was connected by a pipe to the reactor, the flow in the pipe was controlled by two valves, one of which was manual and should have been closed at the start of the operation, the other being electronically controlled by the process. The second valve was normally open and it was intended that it should close in the event of an overpressure. The manually operated valve was without position markings, and the physical position of the valve was difficult to see. When the accident occurred the manual valve was open; starting the process step to add water opened the electronically operated valve and all 30 litres of water were added at once. The control

systems could not respond to prevent any build up of pressure. The peak pressure of the foaming contents was sufficient to break the glass condenser, but was below the nominal pressure of the bursting disk, which was undamaged.

The conception of the automatic control system was fundamentally flawed, as it could only respond once the high pressure alarm had been triggered. In this case all of the water was in the reactor and shutting the valve had no effect.

ACTIONS TAKEN

The plant has since been modified to limit the maximum volume of water which can be added at one time and to improve the electronic control system. The HAZOP studies have been reviewed for all exothermic reactions carried out on in this apparatus. In particular attention being paid to consequences of operating failures and a balance between risk control measures and the potential severity of the consequences.

LESSONS LEARNT

Two main lessons can be learned from this accident :

1. The hazard identification within a HAZOP study must be coupled with a balanced and appropriate approach to risk mitigation and control. Hazards which potentially may lead to loss of control of the reaction require either an inherently safer design approach or highly reliable, fast acting electronic process control systems.
2. The design of the reactor and its peripheral equipment should take account of human factor aspects and support the workers in the operation. This means it should be clearly visible which valves are open or closed. Interlocks and control systems should be used to prevent failures which can lead to the loss of control of the process.

Fertiliser decomposition in a dryer

8 February 2010

Ribécourt-Dreslincourt (Oise)

France

Chemistry
 Fertilisers
 Decomposition
 Organisation / procedures
 Corrosion
 Process control

THE FACILITIES INVOLVED

The site :

This plant produces, stores, mixes, packages and ships solid NPK-type fertilisers. Manufacturing activity includes binary fertilisers (PK, NP and NK), along with liquid fertilisers (NS and NP) though in lesser quantities.

Onsite operations require administrative approvals, in addition to easements, for the storage of ammonia under heading 1136-A-1. Approvals are also required for the onsite storage of ammonium nitrate in hot solution form (heading 1330-2) and for the storage and use of sulphuric and phosphoric acids (heading 1611).

The specific unit involved :

The accident occurred at the fertiliser drying unit.

Fertilisers exiting the granulator were being dried within a rotating tube. An ammonium phosphate slurry, obtained in a tubular reactor by means of reaction between phosphoric acid and ammonia, was sprayed onto aggregates at the dryer intake. The drying stage relied on hot air produced by a natural gas generator operating at a 7 MW heat release rate.

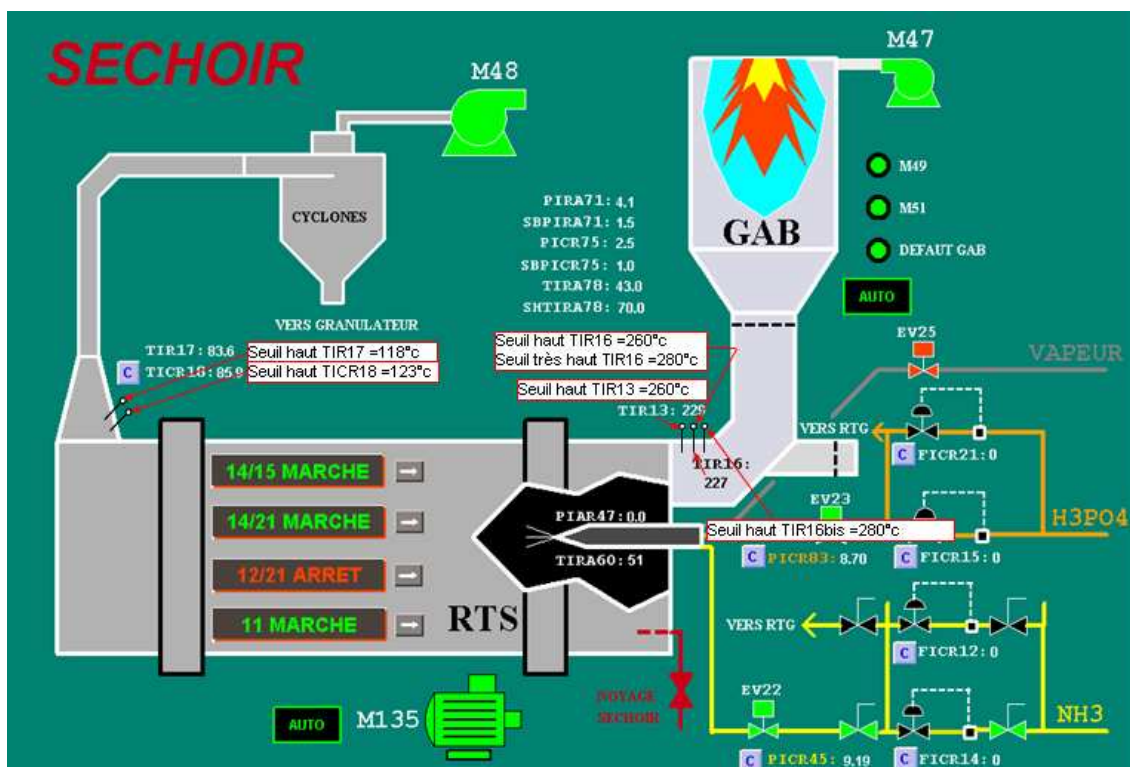

RR

THE ACCIDENT, ITS CHRONOLOGY, EFFECTS AND CONSEQUENCES

The accident :

Around 10:30 am, an employee noticed yellow smoke being emitted from the main chimney of the NPK fertiliser plant. This smoke was caused by a decomposition of the NPK 11-11-32 fertiliser contained in the dryer. To limit the accidental discharge, the technician running the control room shut off the exhaust fan ; the gas resulting from decomposition of this product was thus released into the plant.

Consequences of this accident :

A technician had to be transferred for observation to the Compiègne Hospital after inhaling these nitrous vapours inside the plant.





The internal emergency plan was activated and the local fire crew arrived on the scene at 11:10 am. Once the dryer had been restarted and flooded, fertiliser decomposition could be stopped, with the responsible material removed from the dryer and stored for a full day before reuse by the operator.



Photograph downloaded from the Internet / Expompierdu60

The European scale of industrial accidents

By applying the rating rules applicable to the 18 parameters of the scale officially adopted in February 1994 by the Member States' Competent Authority Committee for implementing the 'SEVESO' directive on handling hazardous substances, and in light of information available, this accident can be characterised by the four following indices :

Dangerous materials released		<input type="checkbox"/>	<input type="checkbox"/>	<input type="checkbox"/>	<input type="checkbox"/>	<input type="checkbox"/>	<input type="checkbox"/>
Human and social consequences		<input checked="" type="checkbox"/>	<input type="checkbox"/>	<input type="checkbox"/>	<input type="checkbox"/>	<input type="checkbox"/>	<input type="checkbox"/>
Environmental consequences		<input type="checkbox"/>	<input type="checkbox"/>	<input type="checkbox"/>	<input type="checkbox"/>	<input type="checkbox"/>	<input type="checkbox"/>
Economic consequences		<input type="checkbox"/>	<input type="checkbox"/>	<input type="checkbox"/>	<input type="checkbox"/>	<input type="checkbox"/>	<input type="checkbox"/>

At the time of the accident, no substance covered under the SEVESO Directive was being emitted into the environment, hence the index relative to hazardous materials released was set equal to "0". Since a technician had to be hospitalised after inhaling the nitrous vapours, the index relative to human and social consequences was scored a "1" (see Parameter H5). No environmental consequences were recorded, resulting in a "0" assigned to the environmental consequences index. Given the lack of detail on property damage costs, the economic consequences index was not rated either.

The parameters composing these indices and their corresponding rating protocol are available from the following Website : <http://www.aria.developpement-durable.gouv.fr>

THE ORIGIN, CAUSES AND CIRCUMSTANCES SURROUNDING THIS ACCIDENT

On Thursday, 28 January 2010 around 7 pm, a leak in Tank No. 3 containing diluted phosphoric acid (10% to 30% P₂O₅) forced technicians to transfer tank contents in concentrated acid form (53% / 54% P₂O₅) into Tanks 1 and 2, thereby causing a considerable dilution to occur: Tank 1 at 42% P₂O₅, Tank 2 at 38% P₂O₅. Tank No. 3 was corroded, and its shell was leaking at a level 1.5 m from the bottom.

On 8 February, the dryer was being shut down to proceed with the maintenance of a chain conveyor. This task was conducted in accordance with a protocol that called for stopping the inflow of raw materials, turning off the dryer and introducing a minimum regime for the burner set at 35%, followed by a cooling phase. These guidelines were respected.

The use of a lower concentration phosphoric acid (38%) than that typically used (53%) caused a thermal disequilibrium of the dryer installation. The slurry of ammonium phosphate powder on aggregates therefore contained more water to be evaporated, resulting in a lower dryer outlet gas temperature. Since this temperature had been set at 110°C, the drying inlet air temperature was automatically raised in order to compensate for this disequilibrium. A temperature close to 300°C was recorded at the dryer inlet instead of the more customary 240°C.

This technically-motivated shutdown procedure transitioned the plant into a dry granulation operating mode with periodic interruptions of the rotating tubes, to ensure the product stayed dry in the granulation loop and avoid clogging by product riprap on the tube walls. Nonetheless, the temperature reached at the dryer inlet, after the cooling phase (according to a procedure that was strictly followed), was 170°C in stead of 110°C due to the high initial temperature (300°C). Start-up temperature for the dry fertiliser decomposition process (above 170°C) was reached inside the dryer inlet tube, thus leading to fertiliser decomposition and the release of yellow smoke. No alarm was sounded since the alarm threshold (370°C) for the hot air intake temperature probes had not yet been exceeded.

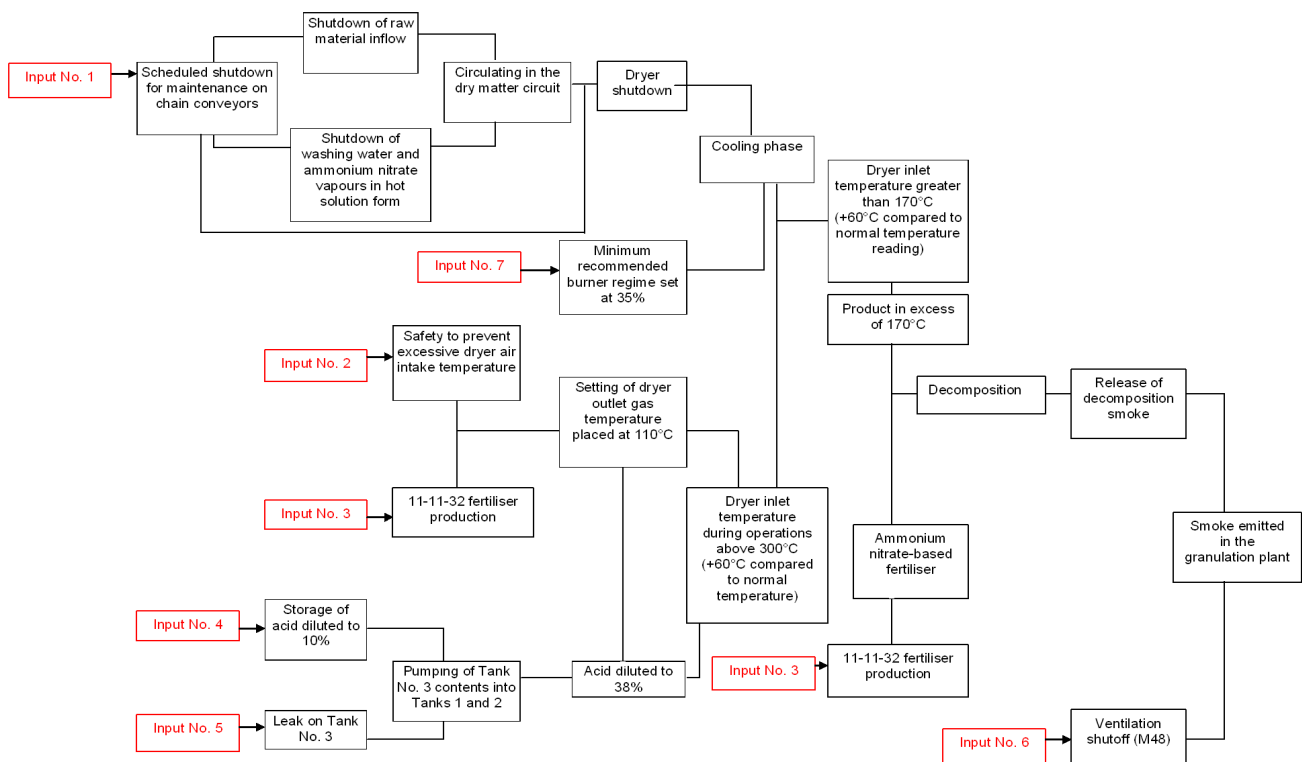

Causal tree of the accident

ACTIONS TAKEN

The assigned inspectors, notified upon activation of the internal emergency plan, arrived onsite and participated in a meeting devoted to the causes and circumstances of the accident. One of the inspectors also took part at the exceptional Corporate Committee for Hygiene, Safety and Working Conditions (CHSCT) assembly held subsequent to the accident. For the annual inspection, the safety management system (SMS) topic discussed was "Process Controls".

The site operator agreed to adopt several measures, namely :

- modification of the manufacturing standards to incorporate an alarm threshold on the hot air intake temperature adapted to each manufacturing process ;
- an alarm threshold for the ammonium nitrate-based fertilisers increased to 260°C ;
- revision of the maintenance shutdown procedure for the purpose of specifying temperature controls and thresholds on the various steps required for the installation shutdown routine ;
- creation of a response guide as part of the internal emergency plan, in order to avoid having a technician shut off ventilation in the event of a toxic gas release.

LESSONS LEARNT

Process organisation, procedures, controls and oversight :

This accident was due to a series of events that had occurred 10 days prior, at which time the contents of a corroded tank were drained into tanks containing more heavily concentrated phosphoric acid. Plant operations continued in a degraded mode, without conducting any analysis of the impacts generated by use of a more diluted acid at the level of the dryer (the case herein) on both the loss of process controls and the release of nitrous vapours.

Moreover, a visual inspection of the acid tanks would have led to observing the corrosion responsible for one of the tank cracks. The inspection and maintenance of all plant equipment are required to prevent against the installation "ageing" phenomenon, providing the setting for operations with an appropriate level of safety.

Managing the feedback loop :

The measures adopted by the operator focus on avoiding any repeat of such an accident, particularly through the rapid detection of an anomaly during the drying step, by means of revising the maintenance shutdown procedure, strengthening controls and refining temperature thresholds.

At the time of the accident, an alarm threshold set at a lower temperature than that corresponding to dry fertiliser decomposition would have allowed technicians to intervene quickly, since the inclusion of an alarm threshold specific to each manufacturing set-up is now expected to more quickly detect and better control process deviations.

The strategy being targeted on the safety management system topic of "process control" lies within the scope of measures to improve the understanding of risks related to installation start-up in degraded mode. Continued operations at a level comparable to the reference thus require more thorough monitoring of the state of degradation for the specific function, along with the implementation of remedial actions and a close recording of their ultimate efficiency. Such an approach assumes greater controls on vulnerable installations and machinery through adapted human and equipment resources.

More in-depth technician training relative to both the process steps to be followed and the types of actions carried out under degraded operating conditions (procedures, response guide, etc.) would serve to erect barriers capable of preventing similar accidental situations.

Explosion in a carboxymethyl cellulose production plant

11 July 2009

Nijmegen (Gelderland)

The Netherlands

Explosion
Fire
ATEX
Degraded mode of operation
Human factor / operating procedures
Risk analysis
Management of modifications

THE FACILITIES INVOLVED

The site :

The company was part of a worldwide organisation with several plants in Finland and China. The site concerning in this case was located in the city of Nijmegen at the bank of the river Waal. This site was licensed to have 50 tons Monochloroacetic acid (MCA), a toxic component which makes it a lower tier SEVESO site.



Carboxymethyl cellulose (CMC) is a cellulose derivative with carboxymethyl groups (-CH₂-COOH) bound to some of the hydroxyl groups of the glucopyranose monomers that make up the cellulose backbone. It is often used as a sodium salt, sodium carboxymethyl cellulose.

CMC (food additive E466) is used in food science as a viscosity modifier or thickener, and to stabilize emulsions in various products including ice cream.

CMC has a high viscosity and is non-toxic and non-allergenic. These properties made it widely-used in many non-food products, such as lubricant, toothpaste, laxatives, diet pills, water-based paints, detergents, textile sizing and paper products.

In Nijmegen this company produced carboxymethyl cellulose (CMC) in two separated production lines. The production was housed in a building which was founded in 1928 for the production of synthetic yarns.

After the production of synthetic yarns was delocalised to low-wage countries in 1969, the production of carboxymethyl cellulose for various applications started in this building in 1970.

The demand for CMC increased and in 1998 the old building was modified to house two separated production lines, one for the production of technical CMC and one for pharmaceutical CMC. Each line consisted of a reactor followed by two in line slurry tanks, a vacuum belt filter a

grinding mill, a dryer and CMC powder storage tanks.

The production section is marked in red on the picture ; the other buildings were used for the office labour and storage.

The production units have walls with a 60 minutes fire protection, sprinklers and LEL detection.

65 employees are working on site in several different shifts, with 25 employees in the factory during daytime. The involved unit operates in a continuous flow mode (24 hours a day and 7 days a week) and is permanently controlled by a team of 2 persons also during weekends.

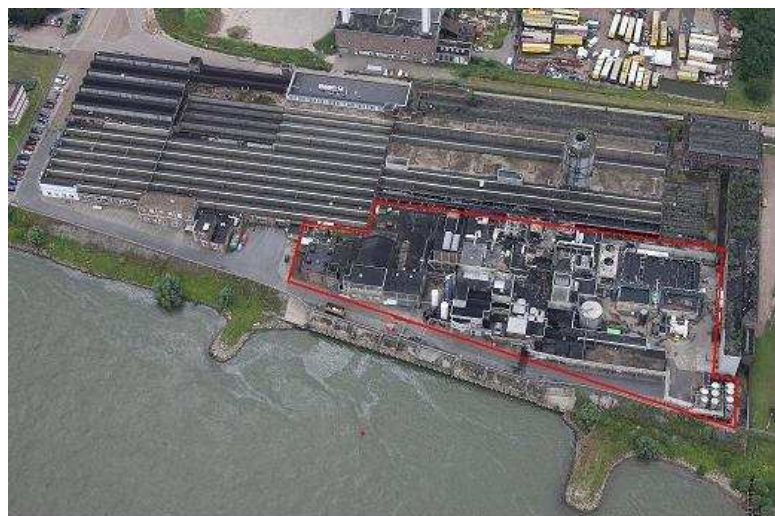

RR

After one synthesis in the reactor, the CMC slurry is stored in a 15m³ tank. This slurry, so-called “Technical CMC”, is a mixture of approximately 60% CMC and 40% salts (sodium chloride and sodium glycolate) and can be directly used, e.g. in detergents. A further purification process is necessary to remove the salts to produce pure CMC which is used for food, pharmaceutical and toothpaste applications. This purification process is carried out on a vacuum belt filter using a 65 %vol ethanol solution.



- 1- Reactor line 1
- 2- Belt filter line 1
- 3- Dryer line 1
- 4- Reactor line 2
- 5- Belt filter line 2
- 6- Dryer line 2

The involved unit :

The involved unit is a vacuum belt filter type RT (Reciprocating Tray). A continuously moving filter cloth is supported inside a rigid, profiled movable vacuum tray, providing the vacuum area of the filter. The bottom of the tray is an open grid structure. The cloth is driven via a head pulley.

The slurry is distributed on the cloth at one end and the liquid from the slurry is removed via the vacuum tray in a first vacuum step.

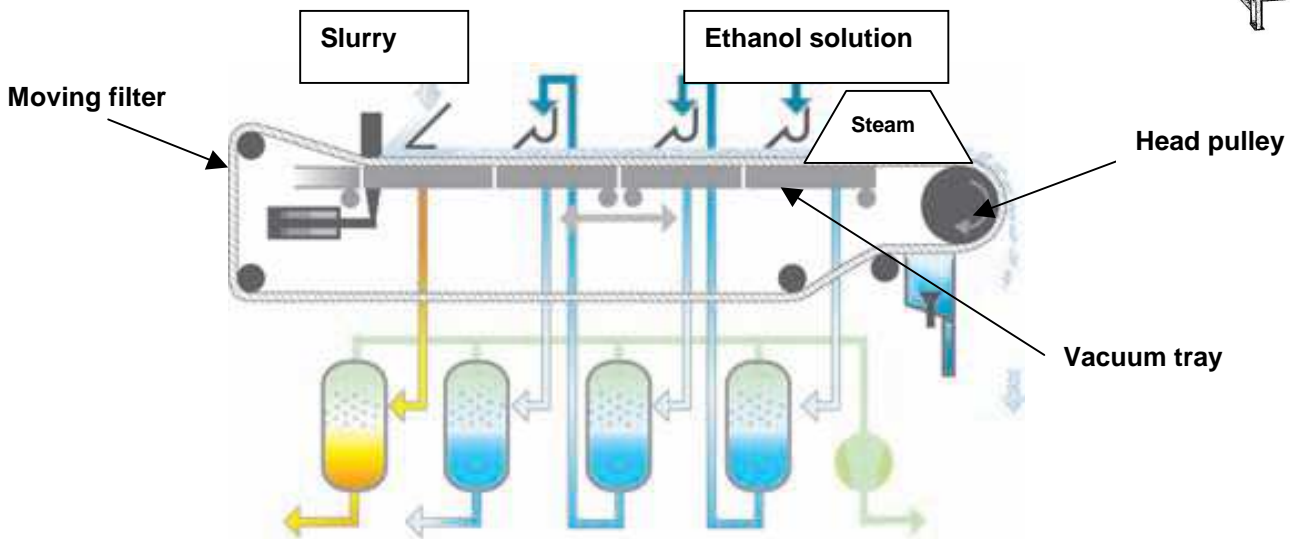
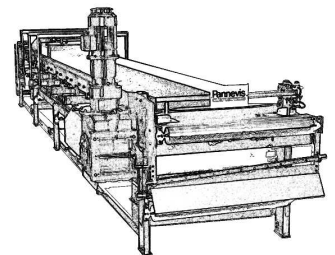

Counter current cake washing (Picture Larox Pannevis R.R.)

In a second step called “counter current washing”, the CMC cake is wet with a 65 % ethanol solution which is then sucked through the CMC cake in the vacuum step.

After three steps of counter-current washing, the cake is dried by a steam injection that removes the ethanol solution from the CMC-cake.



Generic illustration of a RT vacuum belt filter (Picture Larox Pannevis R.R.)



View of the filter inside the enclosure (RR)



Outside view of the steel plated enclosure (RR)

In 1999, the CMC demand was high and the production capacity needed to be doubled. Two new vacuum belt filters were installed in the old factory. No safety facilities such as Explosion Release Control (ERC) equipments were present or installed in the old building.

Good practice is to use a GT (Gas Tight) type vacuum belt filter when a solvent is used during the purifying process. However, due to the experience of this company (difficulty for maintenance, adjusting the belt) and the costs involved (GT Type 3 times more expensive than RT type)) the company decided to buy two RT Types vacuum belt filters and build the enclosure on their own behalf.

Since possible ignition sources were present in the enclosure, the prevention of an explosion entirely rested on upon the prevention of an explosive atmosphere. A nitrogen purge unit was used to prevent an explosive atmosphere in the enclosure.



GT type (Picture Larox Pannevis R.R.)

Around 2003, a chemical expert from this company stated that the nitrogen purge was not necessary. He claimed that the ethanol vapour was presumed to be at its saturation point and therefore above the upper explosion limit (UEL). The drops on inside of the window screen of the enclosure were supposed to indicate the presence of saturated vapour of ethanol inside the enclosure. From this point on, continuously nitrogen purge was no longer applied.

In 2005, the operator wrote a new procedure for operating the vacuum belt filter. In this procedure the nitrogen purge was only applied after opening and closing the doors of the enclosure. Furthermore, the nitrogen purge should not excess 2 hours.

To comply with the ATEX regulation, an explosion protection document was prepared by an external expert. This document showed that the maximum oxygen concentration in the enclosure should not excess 10 %vol O₂. The inerting system inside the enclosure of the vacuum belt filter should be maintained with a continuously purge of nitrogen. In practice however, no nitrogen purge was applied other than two hours during start-up after an open enclosure as described in the procedure.

No other measures like overpressure, minimum flow supply or automatic shut-down, for preventing explosion of an explosive atmosphere (according to NPR-CEN/TR 15281) were implemented. Although an oxygen meter in the control

room showed an oxygen percentage between 18 %vol and 20 %vol during process, the management of the company did not react.

Finally, because of a rise in prices and taxes on ethanol, the company implemented a close follow-up of the quantities of ethanol used (to avoid spills and ethanol vapour losses...). To reduce the loss of ethanol vapour, a cooling system was installed in the enclosure, which cooled the vapour to 24 °C. At this temperature, the potential losses of ethanol were reduced and well monitored, but the volumetric concentration of ethanol consequently came closer to the stoichiometric volumetric concentration (concentration at which the vapour explosion force is the greatest).

THE ACCIDENT, ITS CHRONOLOGY, EFFECTS AND CONSEQUENCES

The accident :

At 6.45 am on that Saturday morning, the vacuum belt filter was automatically stopped because of an emergency shutdown in the CMC dryer installation. It seemed that a large piece of CMC-cake blocked a cell-lock.

This shutdown lasted for 9 hours, as maintenance had to be called in to the factory. The cell-lock had to be dismantled and repaired before installing back into the dryer line.

The remaining CMC-cake on the filter belt was unusable and had to be removed from the filter. In order to do so, a trap door was opened in the closed transport screw that conveyed the CMC cake to the mill and dryer unit. By slowly running the filter belt, the cake was removed from the belt and the cake-breaker and put into waste bags. The opening was then closed and the vacuum belt filter was re-started at 4.00 pm. No nitrogen purge was applied because the door of the enclosure itself, containing the filter and the cake breaker, was never directly opened.



RR

At about 4.15 pm, the supervisor opened the slurry valve in order to continue the production process. Immediately after opening the valve an explosion occurred and destroyed the enclosure and surrounding compartments of the factory and set fire to the building. The stored CMC in the expedition part of the factory smouldered for 38 hours.

Consequences of the accident :

The explosion heavily injured one employee who was working in a compartment just beside the enclosure; he deceased later that evening.

Despite important fire-fighting efforts, the fire of the building lasted for 38 hours, producing a thick dark cloud of smoke over the city of Nijmegen. The authorities decided to recommend residents within 3 km of the plant to close doors and windows.

The installation and building were destroyed and the insurance calculated a damage of € 50 millions.

The company closed its facility in Nijmegen and transferred its CMC production to China, 65 employees were laid off.

The European scale of industrial accidents :

By applying the rating rules applicable to the 18 parameters of the scale officially adopted in February 1994 by the Member States' Competent Authority Committee for implementing the 'SEVESO II' directive on handling hazardous substances, and in light of the information available, this accident can be characterised by the four following indices:

Matières dangereuses relâchées		<input checked="" type="checkbox"/>	<input type="checkbox"/>	<input type="checkbox"/>	<input type="checkbox"/>	<input type="checkbox"/>	<input type="checkbox"/>
Conséquences humaines et sociales		<input checked="" type="checkbox"/>	<input checked="" type="checkbox"/>	<input type="checkbox"/>	<input type="checkbox"/>	<input type="checkbox"/>	<input type="checkbox"/>
Conséquences environnementales		<input type="checkbox"/>	<input type="checkbox"/>	<input type="checkbox"/>	<input type="checkbox"/>	<input type="checkbox"/>	<input type="checkbox"/>
Conséquences économiques		<input checked="" type="checkbox"/>	<input checked="" type="checkbox"/>	<input checked="" type="checkbox"/>	<input checked="" type="checkbox"/>	<input checked="" type="checkbox"/>	<input type="checkbox"/>

The parameters composing these indices and their corresponding rating protocol are available from the following Website : <http://www.aria.developpement-durable.gouv.fr>

The quantity of ethanol in the enclosure was about 300 liters ; the amount of ethanol vapor in the enclosure was about 100 m³. The energy of the explosion caused by 100 m³ ethanol is about 350 MJ, that is ≈ 70 Kg TNT equivalent. Thus, the dangerous materials released parameter reaches 1.

The human and social consequences index reaches 2 since one employee died.

Property damage and production losses was estimated to 50 million Euros. Cleaning and dismantling the building for investigation cost 1.5 million Euros, thus amounting to level 4 on the scale of economic consequences.

Despite atmospheric pollution by the fire, no harmful environmental consequences were reported; the environmental consequences index is not rated.

THE ORIGIN, CAUSES AND CIRCUMSTANCES SURROUNDING THE ACCIDENT

The explosion was the result of an ignition source associated with an explosive atmosphere in the enclosure of the vacuum belt filter :

- The ignition source is not precisely known, as the explosion completely destroyed the vacuum belt filter and surrounding enclosure, but several plausible sources were present: moving items, electrical components and a mechanical cake-breaker inside the enclosure as well as electric lights, pumps and engines outside the enclosure.
- The explosive atmosphere was present due to the presence of ethanol and air. Indeed, fresh air was brought into the enclosure via the opening of the trap door of the transport screw, which led to an oxygen (O₂) concentration of 20 %vol.

300 litres of liquid ethanol were present in the enclosure for washing the CMC-cake. The volume of the enclosure was about 100 m³, filled with air and ethanol vapour. The concentration of ethanol vapour depends on the temperature in the enclosure. The temperature was not monitored but estimated between 24 degrees (temperature of the cooling system) and 35 degrees Celsius (temperature of the ethanol liquid).

Depending on the temperature, the volumetric concentration of ethanol had to be between 5 vol% and 15 vol%.

The stoichiometric volumetric concentration of ethanol is 5.8 vol%. At this concentration, the lowest ignition energy can cause a vapour explosion which is at its maximum force.

Ethanol: C₂H₅OH

Flash Point: 16.6 °C
 Auto ignition temp: 363 °C
 Explosion Limit: 3.3 - 19.0 vol%
 Vapor Pressure: 59.3 mmHg
 Boiling point: 78 °C
 Molecular Weight: 46.04 g/mol

ACTIONS TAKEN

Short after the accident, a security perimeter of 500 m was set up and significant human and equipment resources were put in action including one hundred firemen, twenty-five vehicles and a fireboat to attack the fire from the river. The fire lasted 38 hours.



Fire fighting operations (picture: De Gelderlander R.R.)

Administrative and penal actions :

The investigation resulted in a legal procedure to determine the responsibility of the players involved in the accident. The date for court sessions are planned mid-2012.

Technical actions :

Because the plant and production was not rebuilt, no technical actions were taken. However the Labour inspectorate stopped the same type of CMC production using a vacuum belt filter at a plant 25 km from Nijmegen. This company was forced to take several actions before starting up their vacuum belt filter, which included :

- a new explosion prevention document
- a study of all possible ignition sources,
- measurements to prevent ignition, for instance installing a spring lockwasher under every nut.
- establishing several LEL meters.



This company also made a study of new ways of purifying CMC cake and will replace in 2012 their vacuum belt filters by Rotary Pressure Filters (RPF). A RPF is a compact installation with less space (smaller risk of explosion hazards) and with all moving equipment (possible ignition sources) outside the installation.

LESSONS LEARNT

- Changes in production conditions or operating procedures can generate dangerous situations in the long run. Such changes must be reviewed and a risk analysis should be carried out to ensure the process is safely run.
- Identification and evaluation of explosive atmospheres and associated potential ignition sources are very important to be able to implement safety measures to prevent explosions.
- One has to be careful with data provided by experts in safety reports.
- The force of a solvent vapour explosion is often insufficiently recognised.
- For controlling the risk of an explosive atmosphere by inerting, the Guidance on inerting for the prevention of explosions NPR-CEN/TR 15281 must be fully applied. This means more than one oxygen analyser divided over the enclosure, awareness of temperature pressure and humidity and monitoring and controlling system to shutdown immediately when Oxygen rises up to MAOC (Maximum allowable oxygen concentration).

TECHNICAL REPORT RAPPORT TECHNIQUE TECHNISCHER BERICHT	CEN/TR 15281 May 2006
<hr/> ICS 13.230	
English Version	
<h3>Guidance on Inerting for the Prevention of Explosions</h3>	
Atmosphères explosibles - Guide de l'inertage pour la prévention des explosions	
This Technical Report was approved by CEN on 8 November 2005. It has been drawn up by the Technical Committee CEN/TC 305.	
CEN members are the national standards bodies of Austria, Belgium, Cyprus, Czech Republic, Denmark, Estonia, Finland, France, Germany, Greece, Hungary, Iceland, Ireland, Italy, Latvia, Lithuania, Luxembourg, Malta, Netherlands, Norway, Poland, Portugal, Romania, Slovakia, Slovenia, Spain, Sweden, Switzerland and United Kingdom.	
EUROPEAN COMMITTEE FOR STANDARDIZATION COMITÉ EUROPÉEN DE NORMALISATION EUROPÄISCHES KOMITEE FÜR NORMUNG Management Centre: rue de Stassart, 36 B-1050 Brussels	
<hr/> © 2006 CEN All rights of exploitation in any form and by any means reserved worldwide	

Bursting of a high-pressure steam pipe

28 June 2010

Le Grand-Quevilly (Seine-Maritime) France

Pipes
Steam
Construction defect
Inspection program
Internal emergency plan

THE FACILITIES INVOLVED

The site :

The plant is located within a large industrial zone along the banks of the SEINE River to the west of the Rouen metropolitan area ; the facility is specialised in the production of fertilisers using 4 raw materials: natural gas, ammonia (NH₃), sulphuric acid and phosphoric acid. It contained 4 manufacturing units clustered on the site's southern and eastern zones, featuring:

- an ammonia production unit, with a capacity of 1,200 tonnes/day,
- two nitric acid production units, totalling a capacity of 3,000 tonnes/day,
- an ammonium nitrate production unit, with a capacity 2,100 tonnes/day,
- a special fertiliser (NS/NP) production unit, with a capacity 2,000 tonnes/day.

The site employs a total staff of 340 and comprises on-site storage facilities for both end products and raw materials : 24,000-tonne capacity of cryogenic ammonia storage, 2 ammonia spherical tanks totalling 550 tonnes, 5 nitric acid tanks offering a cumulative 10,000-tonne capacity, a zone dedicated for solid ammonium nitrates either in bulk (12,500 tonnes) or packed in big bags (2,000 tonnes), 4 tanks of ammonium nitrate in hot solution accounting for 4,000 tonnes, another 140,000-tonne zone for special fertilisers as well as various sulphuric acid and phosphoric acid tanks.

The plant layout includes a series of lorry loading/unloading installations for fertilisers, fertiliser and ammonia railcars, and maritime terminals for ammonia, sulphuric acid and phosphoric acid. Site operations is required to comply with the Seveso II European directive for the storage of ammonia, ammonium nitrate in hot solution and solid fertiliser made from ammonium nitrate. The main technological risks identified by the site operator are : toxic leaks of ammonia or nitrous gas, explosion of an inflammable gas cloud subsequent to a natural or process gas leak , overpressure within an equipment, or detonation of out of specification ammonium nitrate material. A town of 27,000 population is located less than 1 km east of the site.



Figure 1 : External view of the site (source: Google)

The specific unit involved :



Figure 2 : Ammonia synthesis unit (source: Google)

The unit involved in this accident is responsible for manufacturing ammonia by means of natural gas steam reforming (see Fig. 2). The ammonia produced by this unit is being used onsite or shipped to clients, as a complement to the ammonia delivered by sea or rail, for the purpose of manufacturing nitrogenous fertilisers.

Inside this unit, ammonia is being synthesized from nitrogen and hydrogen according to the HEURTEY process, whereby nitrogen is supplied by atmospheric air while hydrogen is produced from natural gas (Fig. 3).

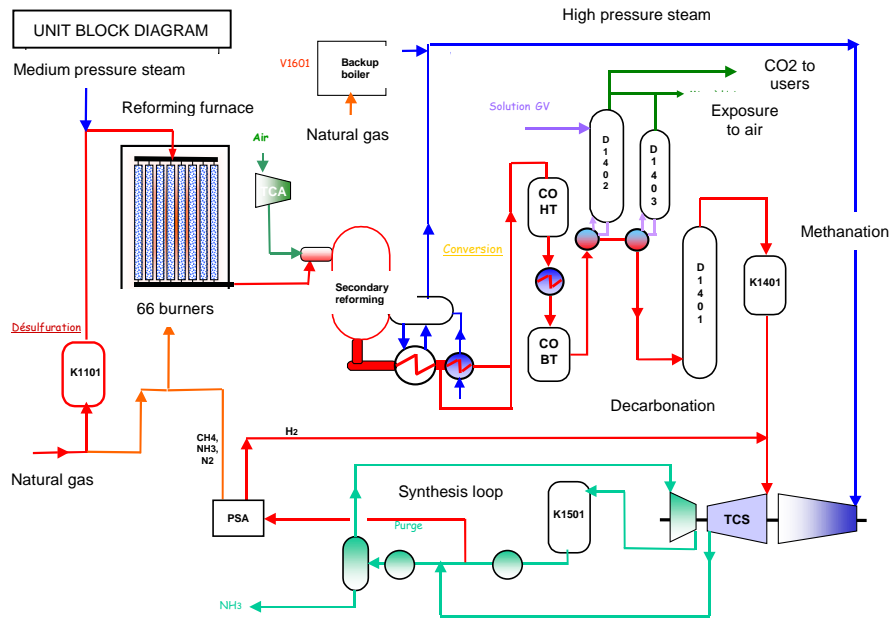
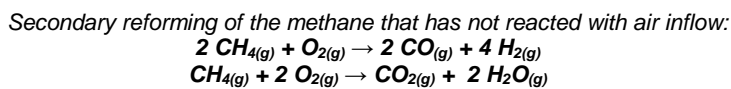
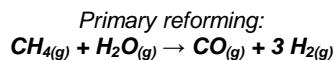

Figure 3 : The HEURTEY ammonia synthesis process (source: GPN)

The three major steps involved in this process are the following :

① In both the reformers and conversion chain, the previously-purified methane (through a desulphurization process) reacts with the water vapour in contact with a nickel oxide catalyst: the methane and a portion of the water vapour are then transformed into carbon monoxide and dihydrogen.



The carbon monoxide is then converted into carbon dioxide, which in turn is recovered to be compressed and liquefied, with the intention of external reuse: $CO_{(g)} + H_2O_{(g)} \rightarrow CO_{2(g)} + H_{2(g)}$

② The small quantities of CO and CO₂ remaining in the synthesis gas are capable of poisoning the ammonia synthesis catalyst. For this reason, the gas is decarbonated in order to eliminate CO₂ ; as a next step, the remaining CO/CO₂ is hydrogenated into CH₄ inside the methanation reactor:

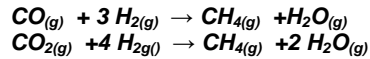

③ The synthesis gas (a N₂/H₂ mix) is then compressed to replicate the physical conditions required for ammonia synthesis. This step takes place in the presence of a high-pressure iron catalyst (100-200 bar) and high temperature (400°-550°C): $\text{N}_{2(g)} + 3 \text{H}_{2(g)} \leftrightarrow 2 \text{NH}_{3(g)}$. Since these equilibrium conditions are not conducive to the reaction, only 20-30% of the synthesis gas is actually converted into ammonia. The synthesis gas that has not entered into reaction then resumes the synthesis loop following extraction of the formed ammonia. The gaseous ammonia formed is liquefied inside the unit's receiving bottle.

The large available quantity of surplus heat stemming from the reformer's burnt gases, change conversion and ammonia synthesis serves to generate high-pressure steam (> 100 bar) and high temperature (> 400°C) through heat exchangers. This high-pressure steam feeds the steam turbines, thus driving several compressors. A proportion of the steam is then extracted from the turbines to supply medium-pressure steam (40 bar) for the steam reforming reaction and for driving other compressors, pumps and fans in some of the neighbouring units (nitric acid production, etc.).

THE ACCIDENT, ITS CHRONOLOGY, EFFECTS AND CONSEQUENCES

The accident :

28 June 2010, at 11:07 pm : A violent blast is heard over several kilometres centred at the ammonia production unit, while the unit was operating in a steady state without any prior incidents, followed by a continuous decompression noise. Two employees on the premises noticed a leak fed by pressurised steam at the level of the chamber roofing on the steam reforming system's smoke chain.

11:07 pm : Technicians placed the unit in safe mode by automatically triggering the equipments shutting down (reforming furnace and other unit processes).

11:10 pm : Dispatch of the plant's fire-fighting crew to the damaged unit for an initial damage inspection.

11:15 pm : Notification of the on-call manager and site supervisors. On their side, public emergency services (Departmental Fire and Safety Office) were alerted following several phone calls by local residents worried by the decompression noise from the affected pipe. The operator chose not to activate the internal emergency siren or even the "mini sirens", given the absence of physical injuries or toxic leaks. The emergency crisis team was activated internally with reminders issued to all on-call personnel. Some neighbouring residents, concerned by the fire-fighters' siren, went out onto their balconies or walked toward the site to watch the accident.

11:27 pm : End of the decompression incident on the damaged pipe and pressurisation of the unit's steam boiler to the atmosphere; the noise noticeable outside the facility has stopped.

11:30 pm : Second inspection conducted by plant fire-fighters in order to assess damage; arrival of the first public fire-fighters emergency vehicles.

11:50 pm : The operator formalised with outside resources the activation of its Internal Emergency Plan; public fire-fighters officers and a municipality representative showing up for a site visit. A command post was established in the site's southern control room.

12:12 am : Plant fire-fighters performed an atmospheric monitoring of ammonia outside the site boundary using a portable analyser. The entire public fire-fighters team (55-person crew) was mobilised but did not intervene onsite.

12:18 am : Following the measures implemented, the absence of an ammonia leak was confirmed.

12:30 am : Telephone exchanges took place with the civil security's emergency room of the local government authorities.

12:41 am : Third inspection by plant fire-fighters, accompanied by members of the management, to evaluate the extent of property damage.

1:15 am : Fourth inspection, this time accompanied by plant supervisors, public fire-fighters officers and the municipality representative, to remove any lingering doubts.

1:50 am : Subsequent to the final field inspection, a joint decision was made to lift the internal emergency plan.

Consequences of this accident :

No hazardous substance listed under the Seveso Directive was released, since the leaked substance was overheated pressurised steam. This steam leak caused the asbestos cement cladding to be ripped off the breeze block wall of the machine room located opposite the blast zone. A 40-kg dished bottom was found onsite at a distance of 230 m from the damaged unit (Fig. 4).



Figure 4 : Photograph of the dished bottom projected on the day of the accident (source: GPN)

The projection of this piece of equipment led to no injuries, yet still caused damages inside the unit: a grated walkway was torn down, and a safety ladder sustained damage. The dished bottom was ejected above the ammonia receiving bottle (placed at the end of the synthesis process) and above an ammonium nitrate conveyor belt to come crashing down between two railway lines. Though these lines happened to be empty on the day of the accident, they were often used to park railcars loaded with ammonia awaiting construction of a full ramp (Fig. 5).

On 6 July 2010, the operator provided the local environmental authority with a metallurgical appraisal of the dished bottom.

On 12 July 2010, the government authority, at the behest of the local environmental authority, issued an order requiring as a precondition to unit restart the introduction of controls to enable detecting similar defects on any of the unit's equipments which might have been damaged, including an analysis of steels quality used for manufacture and the execution of all necessary repairs. Any anomalies identified during this inspection were to undergo repairs prior to unit restart.

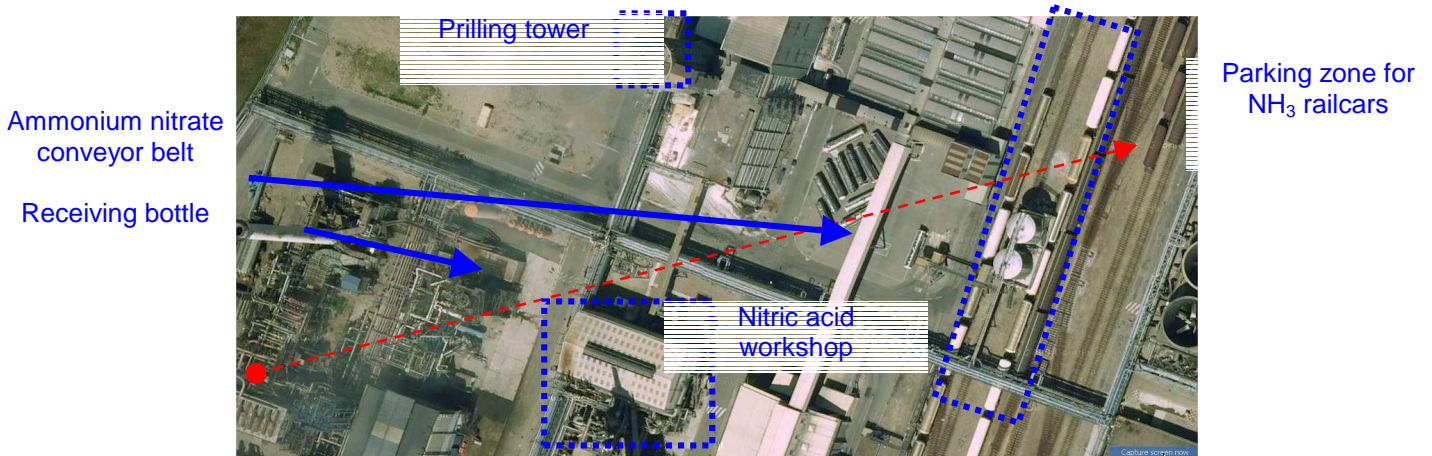

Figure 5 : Trajectory travelled by the dished bottom shown in red (source: Google and DREAL HAUTE NORMANDIE)

The damaged unit had to be shut down for 10 weeks. Given the existing storage capacity and the possibilities for ammonia deliveries by water or rail, shutdown of the site's nitrogenous fertiliser production has been avoided. Nonetheless, the damaged unit had become unable to feed the rest of the plant in medium-pressure steam, specifically to enable unit restart. An auxiliary boiler within the damaged unit was actually capable of supplying steam throughout the site; however, its high-pressure steam pipes needed to be inspected before any attempt at plant restart. The local environmental authority, in considering that all necessary elements and controls had not yet been fulfilled, rejected the operator's request to restart the boiler 3 weeks after the accident.

The nitric acid production unit was finally restarted thanks to steam delivered by a second nitric acid unit that had remained in service, to the detriment of steam supply to the ammonium nitrate and special fertiliser units, both of which had been temporarily shut down. The operator suffered major operating losses, on the order of several million Euros, as the result of a drop in production but chiefly due to the purchase of ammonia on the international market in order to maintain the production of nitric acid and nitrogenous fertilisers. This production was necessary to secure the operator commercial commitments.

The European scale of industrial accidents :

By applying the rating rules applicable to the 18 parameters of the scale officially adopted in February 1994 by the Member States' Competent Authority Committee for implementing the 'SEVESO' directive on handling hazardous substances, and in light of information available, this accident can be characterised by the four following indices :

Hazardous materials released		<input checked="" type="checkbox"/>	<input type="checkbox"/>	<input type="checkbox"/>	<input type="checkbox"/>	<input type="checkbox"/>	<input type="checkbox"/>
Human and social consequences		<input type="checkbox"/>	<input type="checkbox"/>	<input type="checkbox"/>	<input type="checkbox"/>	<input type="checkbox"/>	<input type="checkbox"/>
Environmental consequences		<input type="checkbox"/>	<input type="checkbox"/>	<input type="checkbox"/>	<input type="checkbox"/>	<input type="checkbox"/>	<input type="checkbox"/>
Economic consequences		<input checked="" type="checkbox"/>	<input checked="" type="checkbox"/>	<input checked="" type="checkbox"/>	<input type="checkbox"/>	<input type="checkbox"/>	<input type="checkbox"/>

The parameters composing these indices and their corresponding rating protocol are available from the following Website : <http://www.aria.developpement-durable.gouv.fr>.

The "hazardous substances released" index is rated 1 due to the phenomenon of a pipe bursting.
 The "economic consequences" index was rated 3 as a result of property damage sustained by the unit, coupled with significant production losses resulting from the imposed plant shutdown, whose total exceeded €2 million yet remained below €10 million.
 The other indices were not rated owing to the absence of human, social or environmental impacts.

THE ORIGIN, CAUSES AND CIRCUMSTANCES SURROUNDING THIS ACCIDENT

The dished bottom was convex and welded with a tulip-like shape on a weld-free drawn tube made of P22 type steel (cross-section with 2 dished bottoms). This tube served as a collector for a 14-inch pipeline (DN 350, thickness: 44 mm), conveying the 520°C water vapour at high pressure (120 bar) between a superheater and turbines. The superheater is a heat exchanger that enables recovering excess heat from the unit's reforming furnace in order to increase temperature of the steam produced by the boilers (Fig. 6). The piping was insulated and removed from all machines generating vibrations; it was placed high above ground on the smoke chain chamber roof, at the level of the unit's steam reforming installations (Fig. 7).

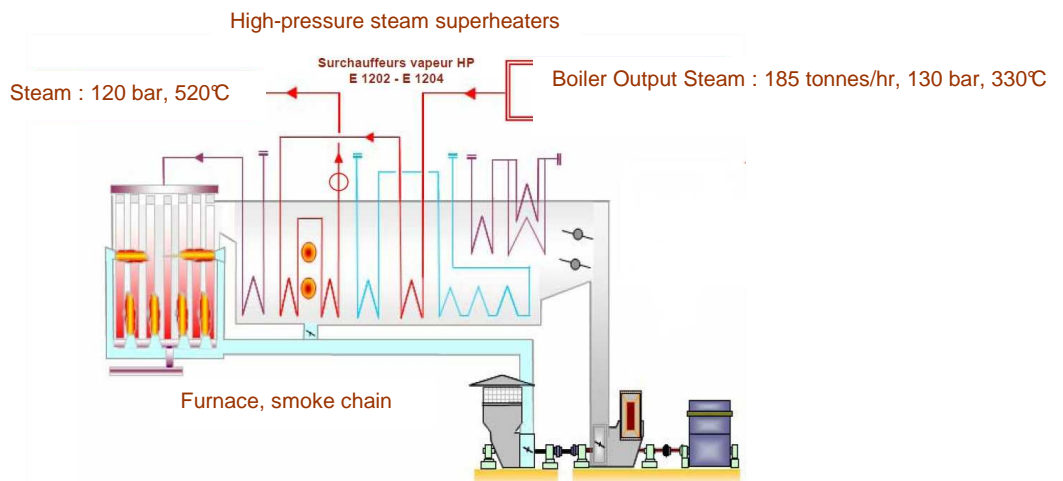

Figure 6 : The unit's overheated steam production circuit (source: GPN)

A break was detected along the bottom weld seam on the tube, over the bonding zone thermally altered by the weld, on the bottom side. The weld has remained fastened to the tube. The operator observes that the only visible flaw was a slightly oxidized surface condition at the level of the break on the dished bottom.

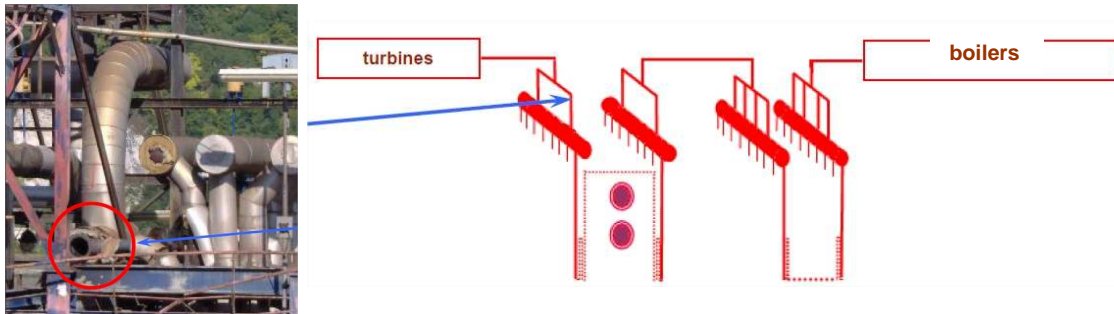

Figure 7 : Localisation of the damaged pipe (source: GPN)

The complete collector tube was built in 1978, but it is not known whether both dished bottoms were welded in the workshop or onsite during unit assembly. This welding operation required preheating at 250°-300°C followed by a heat treatment at 720°-740°C, although no document providing traceability of the bottom welding procedure applied onto the tube has ever been produced. The same shortcoming was observed for pipe manufacturing specifications. Only a radiographic inspection, when the bottom was built, and a hardness verification at the weld surface following heat treatment had been conducted at the time.

Formal pipe monitoring elements first appeared by the end of 2003, during a periodic recertification of the piping performed by an authorised certification body. The report mentioned thickness controls executed by the operator using ultrasonic probes, in addition to visual inspections of assembly surfaces and welds, without detecting any defects. The piping was recertified through 2013, in compliance with the 120-month periodicity set forth in the regulation relative to pressurised equipment.

Between 2006 and the day of the accident, pipe controls were performed on a regular basis in accordance with the periodic inspection plan adopted, i.e.: external visit under normal operating conditions every 18 months, and periodic inspection of the unit during down time every 60 months by the site's internal inspection team which has been approved by the administrative authority (Certified Inspection Department). Since the main objective of this protocol is to detect eventual leaks, the majority of these controls are indeed visual and take place under difficult conditions while the unit is up and running (pipes located high above ground, hot temperatures). The primary anomalies observed pertain to the state of heat insulation, which in certain spots had become detached and deformed. The non-destructive control procedure, undertaken when the unit was down during December 2008 and applied to the dished bottom, did not reveal any loss of thickness. At the time of the most recent shutdown, a section of pipe was cut in order to insert a trial bottom to carry out a periodic recertification of the bundle associated with this pipe. Following testing on this bundle (at 80°C), the pipe was restored to a compliant state and the welds were fully x-rayed after heat treatment. According to the operator, the bottom and its weld were also tested at the same time as the pipe bundle. A search for cracks by means of magnafluxing conducted 3 months prior to the accident on 5 pipe welds did not indicate any anomalies, although the suspected cross-section was not targeted as part of this search.

The pipe inspection plan, adopted in May 2007, focused on the degradation modes by erosion, abrasion and cavitation, while corrosion under the heat insulation has been discarded (service temperature: 520°C). In October 2009, the internal inspection department had requested that this plan include degradation by vibrations subsequent to the recent rupture of a bleed valve on a high-pressure steam pipe in the unit, due to vibrations (water hammer hits) during unit restart sequences. On the day of the accident, this plan had still not been updated accordingly (no specific control of vibration-induced degradations). The dished bottom was sent for metallurgical appraisal to a specialised firm, the outcome of which revealed that rupture was due to the type of steel used to manufacture the bottom. This steel was of the ordinary carbon variety and not adapted to pipes operating at temperatures above 425°C, even though the original specification called for a lightly alloyed steel of type P22 (2.5% Cr and 1% Mo), capable of resisting temperatures above 530°C and pressures on the order of 130 bar. It is important to mention that the pipe and metal used for the weld were indeed made of P22-grade steel.

Furthermore, damage had started to slowly progress on the outer skin of the dished bottom and was gradually entering into the thickness of the zone thermally altered by the weld (slow creep), without any apparent deformation. The metallographic inspection of rupture on the bottom side revealed the presence of oxidized microcracks running parallel to the weld bond zone. The technical appraisal also underscored the fact that the heat treatment performed after welding might have accelerated damage, since the temperature selected had been adapted to a P22-grade steel and not to an ordinary carbon steel.

ACTIONS TAKEN

The administrative authorisation to place the damaged unit back into service was contingent upon an exhaustive control of the installation.

The operator proceeded with an inventory of all pipes potentially containing noncompliant steel or subject to the risks of cracking corrosion due to hydrogen (synthesis gas). An analysis reported 65 critical equipment that would give rise to 969 material analyses involving a portable X-ray analyser (portion of pipes, welds and equipment of the boss, T-section and elbow type, etc.). All of the unit's dished bottoms underwent a materials inspection as well as magnafluxing on their welds, amounting to 12 bottoms made of P22-grade steel and 7 containing P11 steel. Three of the unit's pipes,

subjected to vibrations subsequent to poor operations of the steam turbine regulation system, were included in this weld inspection campaign by use of magnafluxing. An accident analysis allowed the operator to conclude that none of the threshold operating conditions were exceeded.

This inventory exercise was completed on 21 September, 2010 and led to identifying ;

- 4 elements made from higher-grade material than indicated in the original specification (stainless steel coupling, plug and boss), they were all left in place ;
- 3 elements made from lower-grade material than the original specification (a T-section, elbow and tube using P11 steel), they were also left in place since actual operating conditions were not hindered (medium-pressure steam pipe section and pressure surge protection by safety valves) ;
- 12 elements made from lower-grade material than the original specification (carbon steel instead of P22 steel), and were replaced. These elements included a dished bottom on another of the unit's high-pressure steam pipes, boss, a valve and a flange on three steam pipes connected to the backup boiler, and two taps on the damaged pipe. Moreover, a pipe had combined several anomalies on its high-pressure part, where several sections and a valve made from P11 steel were discovered, as well as a carbon steel tube and bleed valve on the neck.

The replacement of noncompliant and damaged equipment was completed on 21 September, 2010, thus making it possible to restart the ammonia synthesis unit. The site returned to a normal production mode, yet the operator was unable to find the original manufacturing specifications for the damaged pipe (since construction records were apparently not kept).

As regards the quality of accident response, the operator held meetings with entities responsible for safety and civil protection (municipality, government authority, etc.) in order to improve coordination in the event of another accident . The plant's communications strategy in the event of an accident is revamped; this new strategy included :

- a specially dedicated phone line to alert the public fire-fighters emergency response service ;
- information within 5 to 10 min to all municipalities in the vicinity through a grouped dialling system, followed by additional messages specifying the instructions to be delivered to neighbours according to the type of accident.

LESSONS LEARNT

Even though the severity of this accident remained rather mild given the absence of domino effects, several lessons can still be drawn, relative to both the causes and circumstances.

As for causes, this accident highlights two significant organisational flaws :

- Deficiency in the control of equipments materials at the time of unit installation. Even though material certificates were verified by an independent control body according to the operator, the steel used on the bottom and 12 other pieces of equipment was not compliant with specifications, and the original pipe construction documentation could never be found.
- Incomplete traceability of pipe monitoring given that until 2003, formalisation of the steam pipe condition monitoring protocol had only been partial (restricted to unit drawings). Formalisation of monitoring procedures was not initiated before the first periodic recertification, in application of the 15 March 2000 decree, though the unit had already been operating for 25 years. Nonetheless, the French regulation relative to plant pipelines (issued on 23rd January, 1962) stipulated in Article 13 that "*the documents, drawings or diagrams, testing and retesting reports, notes from inspections prescribed in Article 12, relative to a pipeline or set of pipelines, are to be archived...*".

From a broader perspective, this accident stresses the difficulties found by the internal and external control entities in detecting such non-compliance in steel. As demonstrated in the inventory of all unit's pipes, this non-compliance does not represent an isolated case. It would be useful to mention that a verification of the steel quality had taken place in 1987 but was limited to those elements prone to hot hydrogen damages. Even if the initial recertification had been conducted in compliance with current regulations (without any imposed hydraulic test, no imposed exposure, original drawings forwarded to the authorised certification body), the question can still be raised whether it was reasonable to limit this verification to just the regulatory control steps in the absence of construction specifications. The organisation of these controls, shared over time among several distinct actors (internal inspection team, certified control authorities and the various external firms subcontracted to perform specific tasks), was not designed to promote efficient monitoring given the lack of rigour in their formalisation.

The operator also conducted verifications on the type of materials found on the most sensitive parts of the site's other units. The local environmental authority requested an operator of similar units located just a few kilometres away to undertake the same kind of verification. Feedback was addressed at the national level to all local environmental authority offices.

As regards the consequences of this accident, it can be considered that a 40-kg steel projectile propelled through an operating ammonia production unit, passing close to an NH₃ receiving bottle, missing the nitric acid unit and a bulk ammonium nitrate conveyor belt only to land in a zone where railcars loaded with ammonia were likely to park, all while causing relatively minor property damage, lies within the realm of "divine intervention". This assessment was underscored in a letter written by the local environmental authority to the operator: "*... the caps, which are massive pieces of equipment weighing some forty kilograms, most likely crossed the most sensitive installations found in the AM2 unit, namely the R1501 bottle, to ultimately land between 2 railway lines at the location of switch 371. These elements attest to the potential seriousness of this incident...*".

This potential seriousness was also fully perceived by the operator, with some testimonials suggesting that some plant employees became aware of the risks related to pressurised steam. It goes without saying that the site's safety reports were focused on the most common hazardous phenomena for this kind of activity, as well as those causing potential effects outside the site boundaries, though domino effects caused by pressurised steam equipments were not included. The scenario with most third-party exposure is based on a toxic ammonia leak (up to an 8-km radius around the site). This scenario recently became more predominant in employees mind given the repetition of accidents of this type arising just a short time earlier at one of the Group's sister facilities located less than 200 km from Grand Quevilly (three months before the accident : ARIA 38959; and one year before with the evacuation of 300 employees receiving significant media attention : ARIA 36660).

Besides, a flaw in the implementation of instructions issued by the internal inspection team has to be pointed out. Following the incident that occurred in October 2009, when the water hammer associated with a restart had caused the rupture of a bleed valve on one of the unit's high-pressure pipes, this team had requested that the pipe inspection plan incorporate the mode of vibration-induced degradation. Eight months later, on the day of the accident, this mode had still not been included even though it would have perhaps allowed to detect the surface defect or the onset of microcracking at the level of the weld (had for example a magnafluxing inspection been carried out on the suspected weld).

On the other hand and despite the communication efforts engaged by the site operator and authorities over major accidents behaviour in the past few years, this potentially serious outcome has gone unnoticed by all neighbours. Several local residents actually went onto their balconies to observe the actions of fire-fighters, while others walked up to the site boundary even though safety guidelines called for residents to remain indoors (Fig. 8).



Figure 8 : Extract from the municipal safety guidelines distributed to localities adjacent to the site

In defence of local residents, the operator's decision to activate the internal emergency plan would have alerted them to the potential seriousness of the incident. Instead, the operator waited for 50 minutes before triggering this emergency plan jointly with the municipality and local authorities. Fire-fighters were notified well before this period, but this notification came from local residents calls, and fire-fighting crews were unaware of the exact situation when they arrived at 11:30 pm in front of the site. Moreover, the decision made at 11:15 pm not to activate the emergency siren on the grounds of an absence of toxic leaks only further sparked the curiosity of some residents upon hearing the leaking steam noise between 11:07 and 11:27 pm, inciting them to get closer to the site. In reality, the operator could not have been completely certain of the absence of toxic leaks until around 12:18 am, after the second inspection of the damaged unit and negative controls of air toxicity around the site. A final inspection of the unit with authority representatives was even considered necessary at 1:15 am to remove any lingering doubts.

Alerting local residents and requesting them to remain indoors, even if not really necessary, would have provided the added benefit of reminding residents that a major accident can occur and would have tested their ability to apply correctly the preventive guidelines.

In conclusion, the operator was late in informing local emergency response teams and neighbouring municipalities, which were unable to notify individuals with information regarding the accident, a shortcoming that further incited the inappropriate reaction of some residents. And yet the plant's locality happened to be one of the few in France to be equipped with an automated call system to quickly and simultaneously alert residents living near the site.

Rupture of an oxygen pipeline

13 June 2010

Richemont (Moselle)

France

Chemical engineering
 manufacture
 Oxygen
 THM/pipeline
 Clean break
 Corrosion

THE FACILITIES INVOLVED

The site :

The site is a top-tier Seveso classified air liquefaction plant subject to Prefecture approval, in accordance with the French regulations regarding classified facilities. It is located in Richemont and is operating several high-risk installations, including :

- a cryogenic production unit
- a splitter (diffusion column)
- storage units for argon, nitrogen and oxygen.

The company also owns a 600-km pipeline network for transporting chemical products within the Lorraine Region (forming a 1,600-km pipeline coverage nationally). The infrastructure is used to supply nitrogen (a gas critical to industrial safety) to many local industries as well as hydrogen and oxygen, two other raw materials vital to industry.

The pipelines have been declared in the prefectural order under a private law regime and no declaration of public interest was required.

The unit involved :

The accident involved the underground gaseous oxygen pipeline, labelled "O₂ Richemont-Gandrange", operating under 40 bar of pressure and buried for 36 years within the site boundary at a depth of 2.5 m.

The pipe, with a nominal diameter of 300 mm (DN 300), is made of E24-4 steel (nominal thickness 4.9 mm / minimum thickness of 4.3 mm / maximum service pressure of 44 bar), featuring a spiral weld, coal tar pitch lining and cathodic protection (-1.4 V).

The pipeline was not internally inspected (e.g. by using an instrumented scraper), so as to maintain the highest purity of the transported industrial gases.

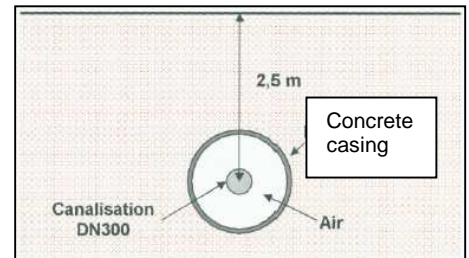

THE ACCIDENT, ITS CHRONOLOGY, EFFECTS AND CONSEQUENCES

The accident :

On 13 June 2010, the pipeline burst around 1:30 pm on the plant's premises at the boundary with public property, where the pipe passes in a concrete pipe underneath the railway that serviced the plant.

The site's internal emergency plan was activated within an hour after the break ; fire-fighting crews and the local gendarmerie were dispatched to the scene. The pipeline was safely isolated by shutting off a valve; by 2:30 pm, an O₂ concentration of 26% was recorded 5 m from the isolated pipeline section. The operator duly informed the facility's clients and issued a press release at 6 pm.



DREAL Lorraine

Around 2 pm, the DREAL Office on call was informed of the break by the Prefecture, and the classified facilities inspectorate went on site.

Consequences of this accident :

The material damages included :

- The oxygen pipeline, "rolled out" in a strip over 1 m, was immersed in water.
- A crater was formed (diameter: 7 m, depth: 3 m). The TNT equivalent was evaluated by the operator at 0.14 kg.
- Pieces of the railway, along with sludge and fragments of pavement and concrete, were projected some 50 m (1-kg debris found 60 m away and 15-kg pieces blasted 30 m).
- A concrete wall located a few metres from the pipeline was partially destroyed.
- The fence was twisted and damaged.
- No fire outbreak was detected on the tube structure, although the onset of combustion was observed on a 220/24 V transformer installed in an electrical utility room 3 or 4 m from the break.



DREAL - Lorraine



DREAL - Lorraine

The production unit was not affected by the incident.

The European scale of industrial accidents

By applying the rating rules applicable to the 18 parameters of the scale officially adopted in February 1994 by the Member States' Competent Authority Committee for implementing the 'SEVESO' directive on handling hazardous substances, and in light of information available, this accident can be characterised by the four following indices :

Dangerous materials released		<input checked="" type="checkbox"/>	<input checked="" type="checkbox"/>	<input checked="" type="checkbox"/>	<input checked="" type="checkbox"/>	<input type="checkbox"/>	<input type="checkbox"/>
Human and social consequences		<input type="checkbox"/>	<input type="checkbox"/>	<input type="checkbox"/>	<input type="checkbox"/>	<input type="checkbox"/>	<input type="checkbox"/>
Environmental consequences		<input type="checkbox"/>	<input type="checkbox"/>	<input type="checkbox"/>	<input type="checkbox"/>	<input type="checkbox"/>	<input type="checkbox"/>
Economic consequences		<input checked="" type="checkbox"/>	<input checked="" type="checkbox"/>	<input type="checkbox"/>	<input type="checkbox"/>	<input type="checkbox"/>	<input type="checkbox"/>

Two parameters were used to determine the ultimate rating of the "Hazardous materials released" index :

- The quantity of O₂ released during the accident, in recognition that this combustible substance is listed in the Seveso Directive with a threshold of 200 tonnes. The quantity was evaluated at 180 000 m³ or 257 tonnes, i.e. 13 % of the threshold, making the corresponding Q1 parameter equal to 4 ;
- The TNT equivalent of the explosion, assessed by the plant operator at 0.14 kg, places parameter Q2 at level 1.

The index relative to the release of hazardous substances was therefore set at 4.

Since the accident led to no human casualties, the index relative to human and social consequences was scored a "0".

Given that no environmental impact was recorded, the index relative to environmental consequences also received a "0" rating.

The economic consequences was evaluated at 1,05 M€, the index relative to the economic consequences equalled 2.

The parameters composing these indices and their corresponding rating protocol are available from the following Website : <http://www.aria.developpement-durable.gouv.fr>.

THE ORIGIN, CAUSES AND CIRCUMSTANCES SURROUNDING THIS ACCIDENT

The causes and circumstances related to this accident were only partially understood. Nonetheless, given that no works were being performed on the line and the absence of any impact from lightning, these two common causes could quickly be eliminated, as could structural fatigue, since all pipeline use reports and recordings would appear to dismiss any cyclical phenomenon like a pressure surge.

Corrosion seems to be the most likely source of this pipeline break. The metallurgical appraisal found the presence of generalised corrosion over a section where a casing crossed the alignment at the point of the accident, making it plausible to conclude that several factors acting in unison were the underlying cause :

- presence of an electrolyte (water), which moreover had a high chloride content
- delamination of the pipeline's anticorrosion lining
- defective cathodic protection
- an over-oxygenated atmosphere.



ACTIONS TAKEN

Another unlined O₂ pipeline together with a N₂ pipeline lined in concrete were also passing underneath the rail track, adjacent to the damaged infrastructure.

The nitrogen pipeline was supplying safety systems at several sites in the Lorraine region. Although it might have been damaged (by fragments or vibrations) inducing a risk of bursting later on, it could not be shut off without forcing the closure of downstream client installations.

The classified installations inspectorate, which received a comprehensive report on the accident (including the internal emergency plan) along with a technical file on the damaged pipeline, requested a number of follow-up measures, namely : introduction of a safety perimeter around the oxygen pipeline ; decrease in N₂ pressure ; and installation of a local monitoring camera.

A prefectural order, issued under the "pipeline legislation", confirmed these measures and furthermore requested expert appraisals on :

- geotechnical issues related to pipeline installation
- the metallurgical condition of the damaged tube and the origin of its break (emphasis on corrosion)
- delamination of the lining, as highlighted by the previous appraisal (results yet to be released).

In order to assess the generic vs. exceptional nature of this event the facility operator implemented a programme to verify all pipelines originating from Richemont displaying similar characteristics throughout the network.

LESSONS LEARNT

The initial expert reports pointed to a number of items, including : installation defects, soil/embankment quality, and differential settlement of poor-quality subsoil layers caused by the railway. Such phenomena should have been visible on the surface yet went unreported, according to the expert, who favoured the hypothesis of corrosion made worse by extended immersion due to the shallow (-2.2 m), fluctuating water table (fed by the Moselle River). The presence of sulphate-reducing bacteria or chlorides could explain the craters on the tubes' external surface.

The investigation also revealed defaults on the pipe form : most of the pipe was slightly flattened, except of thicker a section of pipeline 5 m from the break which had been formerly replaced and which presented different deformation. However, none of the observed mechanical deformation seemed to have an impact on the mechanical strength of the pipes.

The final metallurgical expert's report cited a combination of several factors : defective seal on the shaft, shifting water table level in the shaft creating medium discontinuities for the electrolyte as well as diminished cathodic protection, local deterioration of the lining with delamination of the coal tar pitch. The water reaching the coal tar pitch/steel interface, plus the onset of corrosion penetrating the pipeline and a micro leak of O₂, all helped accelerate this phenomenon.

Above the new segment of pipeline, concrete slabs were installed to distribute the load. The specifications issued in the geotechnical expert appraisal commissioned by DREAL were respected when burying the line.

The monitoring and maintenance plan was updated in order to take this feedback into account.

The other critical pieces of feedback worth noting consist of :

- Activation of the internal emergency plan (upper-tier Seveso site), and not the external emergency plan (as should have been the case with regards to the pipeline regulation), since the accident occurred on transport infrastructure at the boundary of plant premises, as opposed to an "plant pipe"; these boundaries need to be indicated in the safety reports, i.e. the degree of pipeline coverage in the internal emergency plan.
- The safety studies on installation techniques and local hydrogeology/geotechnics need to be complemented to better comprehend the "water table fluctuation" hazard and, more generally, all geotechnical aspects.
- The distances at which damage appear after such a "clean break": crater, wall, projections. Beyond having to verify the operator's safety report data, the zones encompassing significant lethal effects, sub-lethal effects and irreversible effects for this category of pipeline should be reviewed.
- Not including third-party works or landslides, corrosion can be the trigger event of a total pipeline break.



DREAL Lorraine

Analogies

The studies of the 13 accidents made by the inspectors of the IMPEL network and the lessons learnt from them are written down in reports produced in the previous chapter. They enabled to touch different recurrent issues of the industrial accidentology.

For each one, the European inspectors could refer to synthesis illustrated on technical and organizational levels with a number of similar accidents recorded in the ARIA database. The corresponding synthesis are given in the following pages.

1-2	Management of health-related and environmental impacts	Page A1
	Saint-Cyprien (Loire) - France - 22/08/2008	
	Plaine-de-la-Crau (Bouches-du-Rhône)- France - 07/08/2009	
3.	Design, monitoring and maintenance of industrial sludge basins	Page A11
	Kolontár - Hungary - 04/10/2010	
4.	Bringing gas-powered installations back online	Page A19
	Saint-Avoid (Moselle) - France - 15/07/2009	
5.	Rail accidents in urban areas.....	Page A25
	Viareggio - Italy - 29/06/2009	
6.	Inadequate use of available feedback	Page A35
	Gonfreville-l'Orcher (Seine Maritime) - France - 04/08/2009	
7.	Lightning : direct and indirect effects	Page A47
	Ibbenbüren - Germany - 23/07/2009	
8.	Striking a balance between prevention, mitigation and intervention.....	Page A53
	Manosque (Alpes-de-Haute-Provence) - France - 01/05/2010	
9.	Risks deriving from the coexistence of automatic and manual systems.....	Page A59
	Heilbronn - Germany - 21/09/2010	
10-11	Operations in a degraded mode	Page A65
	Ribécourt-Dreslincourt (Oise) - France - 08/02/2010	
	Nijmegen – The Netherlands - 11/07/2009	
12-13	Monitoring of equipment characteristics	Page A77
	Grand-Quevilly (Seine Maritime) - France - 28/06/2010	
	Richemont (Moselle) - France - 13/06/2010	



Management of health-related and environmental impacts



Treated wood fire causing dioxin emissions

ARIA 35035 – 22/08/2008 – 42 – Saint-Cyprien

38.32 - Recovery of sorted waste

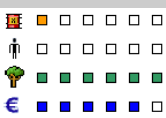

In a wooden pallet recycling plant located on the former site of a company recovering electrical transformers, a fire of unknown origin broke out at around 4 am in a 2 000 m² wood storage area. The security guard of the site spotted the fire and called the emergency services, who responded using several water nozzles. A thick cloud of smoke was seen above the village. The inspection authorities for classified facilities observed that the wood stock was likely to have been soiled or treated with chemicals and that the volume of the wood stored was greater than the quantity allowed by the authorised operating regime. An emergency order recommending the analysis of underground water in the site and in the neighbouring farming areas was issued.

The 3/09, the wind reactivated the smouldering, requiring a new emergency response. The prefect then took several orders: suspension of activities, emergency site cleanup and disposal of waste, as well as formal notice to regularize the administrative situation of the company. Three months will ultimately be needed to extinguish the fire.

The 15/09, a specialized agency installed equipments to monitor air quality. Analyses released on 18/11 showed significant air emissions of dioxins and polychlorinated biphenyls (PCBs). The 26/11, veterinary services took samples of milk in a farm nearby. A contamination is revealed with concentrations of pollutants well above the regulatory limits for the marketing of foodstuffs (EC Regulation 1881/2006/CE). The farm is placed under sequestration.

Gradually, the investigation zone was increased from 1 to 2 km radius in March 2009 then to 5 km in April. On 25/05/2009, the surveillance zone was extended to 40 municipalities by prefectural order then to 42 municipalities in August 2009. In July 2009, a specialized agency announced that the origin of the contamination of soils would be difficult to determine beyond a 2 km radius. In total, 914 farms have been investigated. Sanitation protocols were launched and 2 255 animals were slaughtered (cattle, sheep, pigs and horses). Meal rendering were burned in a local cement factory, the grease that may have contained PCBs were treated in Belgium. Nearly 187,000 l of raw milk were eliminated.

The waste generated in the disaster were mostly made of crushed wood stocks and sludge from land clearing. The transportation of these wastes in specialized areas took place between the 10/07 and 31/07/2009; 70 trucks will be needed to remove 1 678 tons of wood and 8.14 tons of sewage sludge. A complementary transportation was dedicated to polluted personal protective equipment, extinction waters and retention basin cover. However, 7,600 cubic meters of contaminated land are still to be removed from the site. Given the amount of cleanup costs (close to 2 million euros) and given that the site is now considered with "responsibility failure" (the company was put into liquidation on 23/7/2010), the intervention of a public body will be needed to ensure site safety and propose a sustainable management of the situation.

In January 2011, three farms are still partially under sequestration. The French agency for food safety, consulted repeatedly, provided measures to mitigate risks of contamination in the food chain. The investigation (including analysis), destruction of animals and products, and compensation are evaluated at 4.5 million euros at end January 2011.

The decree and order dated 19/06/09 (Decree establishing a compensation scheme and laying down detailed rules for the estimation of slaughtered animals and destroyed food products on the orders of the administration during a contamination of agricultural products) allowed the state to compensate for the heaviest part of the pollution (destruction of animals and contaminated feed).

In addition, Article 26 of the Agricultural Modernization Law of 27/07/10 established a national fund for managing agricultural risks (FNGRA). This fund is intended to help financing management features against climate, sanitary, phytosanitary and environmental hazards in agriculture.



ARIA 36654/Photo credit: Fire Services13 (RR)

Pollution of a nature reserve by fuel oil leaking from a pipeline

ARIA 36654 – 07/08/2009 – 13 – Saint-Martin-de-Crau

49.50 – Pipeline transport



A leak was discovered on a crude oil pipeline (diam.: 40", maximum service pressure: 40 bar, built in 1972) composed of welded rolled tubes. The accident occurred on a Natura 2000 site in the Crau Natural Reserve, home to several protected species. A park warden sounded the alarm and the operator activated the pipeline's emergency plan.

Rescue crews and various administrative departments were onsite by 8:30 am. Aerial reconnaissance was performed and a safety perimeter set up. A "geyser" 3 to 4 m high gushed from a "buttonhole" rupture 15 cm wide and 1.8 m long on the longitudinal weld.

The Prefecture convened a crisis monitoring cell at 11:15 am. The Secretary of State for Ecology arrived on the scene at 4:30 pm, and the court was seized. The Prefecture requested a precise evaluation of environmental impacts. According to the operator, the pipe break was due to a fatigue crack caused by the "roof effect" at the level of a longitudinal weld bead. The damaged tube was replaced by a new one; others were inspected and reinforced as a preventive measure.

5,4000 m3 of crude oil were discharged over a 5-ha land area. Surveys, coring and analysis of land are made to thoroughly assess the impact of pollution on the area. The water table is situated between 9 and 12 m depth, 72 piezometers were gradually installed in the following months to monitor the impact of pollution on groundwater together with a hydraulic barrier to contain the possible migration of the pollution. Analyses carried out regularly by the operator of the pipeline at the request of the authorities showed that no hydraulic capture downstream, either for irrigation, animal feed or human consumption, has been affected. Many studies were conducted to assess the impact of the accident on the local fauna and flora of the reserve. However, the consequences are difficult to assess beyond the polluted area due to a lack of accurate baseline even within a nature reserve. The Coussoul (flora) is yet destroyed over 5 acres.

A year after the accident, the operator claimed having spent 50 million euros to "treat" the consequences of the leak, including a dozen for environmental restoration. On the whole, at the end of 2010, more than 73 000 tons of contaminated soil have been disbursed, then transported to a processing centre of a neighbouring department. These lands came from the stripping of polluted soils over a 40 cm depth. In the 5 ha area, a depositing was carried out with local materials transferred from a nearby quarry, respecting the original structure of the soil. The surface layer was reconstructed by directly transferring the Coussoul taken from areas not yet exploited of the quarry. Scientific monitoring is planned to observe the recovery of this Coussoul. The work is completed April 15, 2011.

Given the succession of accidents that occurred during 2009 in the chemical and petroleum industries, as well as in the pipeline transport of hazardous materials sector, a meeting on industrial safety and environmental protection was organised in September 2009 between the Secretary of State for Ecology and key leaders in these sectors. Participants submitted proposals for improving safety at their installations, by means of strengthening controls and maintenance on ageing facility, while paying greater attention to ecologically-sensitive zones with the aim of better caring for protected species / zones.

Further to this accident and as an experiment, the Secretary of State launched in August 2010a project to build a natural reserve near the affected area to "cultivate assets" that could offset negative impacts on biodiversity. For that purpose, a specialized company will restore rare and endangered species habitat by transforming an industrial orchard in a pasture zone.

Management of health-related and environmental impacts

A number of accidents illustrate the possibility of immediate or delayed effects on human health and the environment from certain toxic or highly non-degradable substances emitted into the environment. These effects may give rise to :

- pollution of soils, surface water or groundwater by various means: fire extinction waters (ARIA [161](#), [5187](#), [18379](#)), direct flow of substances present onsite following a loss of confinement (ARIA [17265](#), [23839](#), [36654](#)), wastes generated by accidents...
- atmospheric pollution (ARIA [5620](#), [7022](#)) ;
- contamination of food resources (fruits, vegetables, milk, meat, fish, etc.) through fallout of accidental emissions (gusts, explosion, fire, etc.) or via water resource pollution (ARIA [161](#), [5620](#), [20493](#)) ;
- adverse alteration over the short or long term of the state of human health as a result of direct or indirect exposure of individuals to hazardous materials or agents dispersed by accidents ([5187](#), [5620](#), [20493](#), [35035](#)), or as an outcome of the psychological impact of the particular event (loss of human life, significant property damage to a point of affecting living conditions, etc.) (ARIA [4225](#), [17730](#), [21329](#)).

Hazardous substances can thus be identified, even several months after the accident, in human or animal food supply (water, crops, cattle), at concentrations sufficient to constitute a threat to human health or the environment. When risks related to such events have not been adequately identified, then health-related threats are typically notified via existing monitoring systems (air or water quality, control of foodstuffs, etc.), yet the alert is often issued at a rather late stage. The response to this kind of contamination may require extreme measures along the lines of shutting down, sometimes definitively, drinking water supply sources in polluted settings (ARIA [161](#), [38373](#)), removing from the distribution chain and destroying contaminated food (ARIA [5620](#), [20493](#), [35035](#)), and undertaking epidemiological or environmental monitoring combined with remedial actions or ecosystem rehabilitation (waste management, excavation of polluted soil for treatment, cleaning of birds caught in an oil spill, etc.) (ARIA [4225](#), [16879](#), [18379](#), [20493](#), [34351](#), [35035](#)).

The technical handling of circumstances and the ensuing crisis situations prove even more challenging to address when the underlying issue arises unexpectedly without any preliminary indication of accident potential and without proper equipment to respond.

Major difficulties encountered during the accidental phase may complicate the technical management of subsequent actions:

- Responsibilities are not always clearly established when faced with urgent steps to be implemented (multiple, defective or nonresponsive operators, execution breakdowns, time lost due to litigation proceedings, etc.) (ARIA [4225](#), [18379](#), [30269](#), [35035](#)). Should operators be slow to act, the administration would be instructed to implement specific procedures stipulated by law, while taking into account local concerns and, if applicable, the state of emergency in order to determine appropriate administrative measures and field actions.
- An estimation of the cost of measures required is rarely available for either the investigation or the "remediation".
- In the case of legal seizure, the inability to intervene (due to judicial proceedings) at affected facilities may exacerbate certain consequences (ARIA [13050](#): delayed implementation of onsite health protection measures relative to decomposing animal carcasses, vermin, odours, etc.). These risks would need to be explained to judicial authorities to help clarify their decisions.
- It is also necessary to answer questions legitimately raised by neighbouring residents, associations, elected officials, and the local / national media as the incident plays out regarding: known details, uncertainties, proven consequences (whether possible or potential), measures already adopted and to be adopted, handling of costs and compensations. These responses must be prudent and acknowledge known realities without seeking to provide unfounded reassurance, especially when investigations (sampling - analysis - interpretation) are ongoing and when results and interpretations are not yet available (ARIA [20493](#), [21329](#), [30269](#)).

These difficulties may trigger crises that are complicated to manage effectively. The affected parties and the media can make demands to the site operator, but also to administrative agencies and emergency services, although studies or information collected on the potential or non-visible consequences are not available, first analyses or measures required for an accurate characterisation of the problem and design of remedial steps have not or insufficiently been conducted prior to and during the accident, or may require additional time before yielding usable results.

Moreover, given the lack not only of sufficient forecasts comparable to the accident but also of appropriate mitigation and intervention measures, initial attention tends to focus on immediate and perceptible effects (smoke plumes and soot, damage, psychological shocks due to human and property loss, etc.), knowledge of the type and quantity of materials involved, and then the quantities of hazardous materials potentially released or generated.

Collection of reliable data and their interpretation could impose a lag phase (for more accurate knowledge furnished by the operator on the substances and quantities actually present onsite or released by inventory analysis, identification of exposed vulnerable components, field analyses, modelling applications, reference values), thus complicating any evaluation of possible pollution extension and actual/potential consequences. This difficulty affects communication with the civil society as well as implementation of initial measures intended to contain the pollution, prevent or limit exposure, and establish and then undertake resorption steps (ARIA [5187](#), [5620](#), [17115](#), [30269](#), [34893](#), [35905](#)).

For all these reasons, it cannot be stressed enough the need for companies to anticipate situations that correspond to potential and reasonably predictable scenarios: safety report, characterisation of possible consequences, emission prevention steps, mitigation, exposure prevention, intervention protocol, exercises on emergency plans, measurement and evaluation of effects and consequences, availability of reference values, requisite health and environmental skills, instrumentation and expertise, loss prevention information and updates provided to stakeholders and authorities, preventive warnings, remediation...

Besides the technical aspects associated with managing predictable risks, site operators must, in addition to issuing warnings to the local population as mandated for all SEVESO classified facilities, be prepared to communicate the accident status to neighbours, elected officials and the media, relative to situations encountered, appropriate reactions and measures to adopt, plus the sequencing of actions implemented by the company. This messaging, which by dealing with health and environmental risks is highly sensitive, would need to be coordinated with authority statements, allowing each party to concentrate on their respective fields of competence.

The technical handling of events and related public communication should be anticipated according to a protocol adapted to the scope of the potential scenario (magnitude and duration of the accident, its effects and consequences, sensitivity of the neighbouring community and the environment), as well as to the critical nature of questions likely to be raised by civil society and its opinion organs. This preparedness implies: a level-headed assessment of the particular type of situation, definition of action strategies to cope with possible scenarios, introduction of effective operational procedures, and completion of drills to test the organisation and its capability to act and communicate.

Given the specific set of challenges and vulnerabilities (proximity of residential zones, crops, farms, food production, water supply resources, protected flora or fauna), the emergency action plan adopted may need to be extended by other actions over time. Depending on the nature and significance of the case, as well as the level of interest or concern potentially expressed by affected residents, it may be worthwhile to set up a monitoring and information system devoted to the actions underway or planned. An evaluation and monitoring committee-type organisation involving local actors (e.g. universities, experts, associations) could facilitate mutual understanding of what are often numerous constraints and difficulties, in addition to defining actions, interpreting evaluations, producing formal communications and tracking actions over time (ARIA 17115, 34351). Beyond holding important committee-level discussions, communication and results interpretation are both also improved by such formalisation using an appropriate medium that serves as a reference for all parties to draw opinions.



Additional references (detailed accident data sheets):



- ARIA 161: Auzouer-en-Touraine, 1988 / Water pollution subsequent to an explosion in a chemical plant
- ARIA 2257: Petit Couronne, 1990 / Leak of premium grade fuel into the water table
- ARIA 4225: La-Voulte-sur-Rhône, 1993 / Derailment of a train transporting hydrocarbons
- ARIA 5187: Schweizerhalle, 1986 / Pollution of the Rhine River by pesticides
- ARIA 5620: Meda, 1976 / Seveso accident: Atmospheric discharge of dioxins in a chemical plant
- ARIA 13050: Amberieux-en-Bugey, 1998 / Fire outbreak at a meatpacking plant
- ARIA 17115: Clermont-Ferrand, 2000 / Fire at an elastomer warehouse
- ARIA 17265: Baia Mare, 2000 / Water pollution caused by cyanide effluent
- ARIA 17730: Enschede, 2000 / Explosions and fire in a fireworks depot
- ARIA 18379: Marly-la-Ville, 2000 / Fire outbreak in a warehouse
- ARIA 20493: Vénizel, 2001 / Atmospheric pollution after ignition of transformers containing PCBs
- ARIA 21329: Toulouse, 2001 / Explosion in a fertiliser plant
- ARIA 23839: Chalampe, 2002 / Long lasting cyclohexane leak
- ARIA 30269: Béziers, 2005 / Fire outbreak in a pesticides depot
- ARIA 34351: Donges, 2008 / Fuel oil spill into an estuary during a material transfer operation
- ARIA 35905: Anvers, 2008 / Release of H₂S in a refinery with cross-border effects
- Guide for managing environmental and health-related impacts, for distribution to local public authorities
- Ecological monitoring of accidental water pollution, CEDRE, 2001 (downloadable at the following Web address: <http://www.cedre.fr/fr/publication/guides/suivi-ecologique.pdf>)



Accidents whose ARIA number has not been underlined are described on the site:



www.aria.developpement-durable.gouv.fr



   **ARIA 5620 - 10/07/1976 - ITALY - MEDA (SEVESO)**

  **24.4 - Pharmaceutical industry**

  A chemical plant that had stopped its production for the weekend released a toxic cloud containing 2,3,7,8-tetrachlorodibenzodioxin into the atmosphere : 6½ hours earlier, at the end of the shift, the production cycle of 1,2,4,5-trichlorophenol had been stopped while only 15% (instead of 50%) of the solvent (ethylene glycol) had been distilled. Agitation was stopped and the vacuum broken. No water was added to the mixture. The unit was left unsupervised for the weekend. At 12.37 pm, the safety valve, calibrated at 3.8 bar, ruptured due to the increase in temperature and pressure in the reactor. The heating of the reaction mixture's surface at rest initiated the secondary exothermic reaction forming the dioxin. It was only the next day that the company informed the authorities that a release of herbicide had occurred. Two days later, crops were declared unfit for consumption. The company reported the dioxin release only 10 days later. In all, 11 communities were effected, including 2,000 ha contaminated. 3 zones were defined: zone A ($C > 50 \mu\text{g}/\text{m}^2$) covers 110 ha, its 736 inhabitants were evacuated; zone B ($5 < C < 50 \mu\text{g}/\text{m}^2$) covers 270 ha, children and pregnant women were evacuated during the day, agriculture and animal husbandry were prohibited; zone R ($C < 5 \mu\text{g}/\text{m}^2$) measuring 1,430 ha. More than 250 case of chloracne were diagnosed, and 220,000 people were exposed to the pollution. In all, 81,000 animals were kill or had to be put down. The quantity of dioxin released has been evaluated between 200 g and 40 kg. The decontamination of the zone began 6 months later and lasted 5 years. The topsoil of the contaminated zones, the demolished constructions and the remains of the contaminated animals were buried in 2 pits, in zone A. Wastes and materials from the plant were placed in drums for subsequent incineration. One year later, 511 people from zone A returned home and zone R returned to agriculture. Zone A was decontaminated and zone B was again declared fit for construction in 1984. The installation was dismantled. In 1985, the plant's management was sentenced to suspended jail sentences ranging from 2.5 to 5 years. The company paid more than \$240 M in damages to the residents and communities concerned. The epidemiological studies have not established a concrete link with all long-term pathologies (cancers, deformations...). Only an increase in the proportion of female births in relation to male births was observed.

   **ARIA 5187 - 01/11/1986 - SWITZERLAND - BASEL**



   **20.20 - Fabrication of agro-chemical products**



  A fire broke out within a warehouse (depot 956) containing phytosanitary products south of Basel. The first responders had been on the scene for 20 min. when fire-fighting teams from neighbouring sites arrived to provide backup. The 80-m high flames were visible more than 10 km away. Thiols in the smoke spread a rotten egg smell, and the Rhine was heavily polluted. Since the retention basin set up onsite was limited to a capacity of 50 m³ of effluents, between 10 and 15,000 m³ of the millions of l of fire water used to douse the flames spilled for 28 h via the wastewater network into the river ; 30 t of toxic products (insecticides, mercury...) destroyed all aquatic life over a radius on 250 km.



The time lapse between the beginning of the accident and the warning announced to Basel residents and bordering countries outraged public opinion. Since, local operations centres have established their own procedures. A new safety & environment organisation was implemented by the industrial group, allocating backup human and equipment resources per each operating division. On November 12, the Environment Ministers of countries affected by the disaster gathered in Zurich to persuade the Swiss government to enact legislation similar to the Seveso Directive for classified facilities, in addition to financing the river reclamation project. Switzerland wound up passing legislation resembling Seveso, thus improving safety at industrial sites and facilitating information flow between adjoining countries in the event of accident. On 10/01/1987, the International Rhine River Protection Commission (CIPR) adopted Rhine Action Program 2000, an ambitious plan aimed at restoring river quality. The cost of these environmental cleanup and rehabilitation measures exceeded Euros39 million. The CIPR now operates 6 warning stations that continuously monitor a section of the Rhine with 2 additional stations assigned to the Moselle River. This disaster also initiated creation of France's SAGE & SDAGE water planning and management agencies.

The accident was caused by the ignition of a pallet containing "Prussian blue" compound. Tests conducted indicated that this powder, made from iron salts and potassium ferrocyanide with a relatively low flashpoint (230 °C), could smoulder for several hours without emitting any odour before igniting. Since this substance had been designated for storage under special conditions, the pallets were wrapped in a thermo-retractable plastic. This packing operation took place outside and was followed by a half-day of outdoor exposure; such a practice was intended to identify the onset of combustion and avoid storage adjacent to other toxic/inflammable products in depot 956. Ten tonnes were packaged on October 30 inside the depot, using a 30-cm sheet of thermoforming material; the product was then stored near 83 t of highly flammable and toxic insecticide & herbicide.

   **ARIA 161 - 08/06/1988 - 37 - AUZOUER-EN-TOURAIN**

  **20.14 - Manufacture of other basic organic chemicals**

   An explosion and a fire occurred during the night in a chemical plant during the manufacture of a silicon oil- and additive-based waterproofing agent.









   A junior technician (hired 6 months back), recently assigned to this post, was left without supervision around 1.00 am to manage a process modified in June and implemented for the second time. Since the

order of addition of reactants was not specified in the operating procedure, he loaded 800 kg of oil into the tank 1702 on level 1, started heating the reactor, went back to level 0 to pump the reagent. While going up to level 2 to fill a tank with water, he observed a kind of fog escaping from the tank 1702. The explosion that occurred around 3.00 am resulted in the formation of hydrogen generated by the decomposition of the silicon oil after the abrupt and uncontrolled addition of an extremely basic alcoholate. The fire that ensued consumed 500 tonnes of chemicals (mainly alcohols), spread to significant part of the site (7,000 m²) and resulted in a huge cloud of smoke.









The technician was thrown 10m away, suffered a concussion and sustained serious burns and injuries. During the rescue operations, 2 fire-fighters were injured and 15 other poisoned. Despite the difficulties encountered, the rescue workers brought the situation under control in 4 hours. Analysis of the air revealed low levels of CO and NOx. The absence of retention devices, unused pipes and malfunctioning of the internal waste water treatment plant led to the disposal of the fire water (cyanide compounds, pentachlorophenols, etc.) in the Brenne river, a tributary of the Cisse river. Both the Cisse and Brenne rivers were polluted over 23 and 5 km respectively wiping out all traces of plant and animal life: 20 tonnes of fishes, aquatic and terrestrial mammals were destroyed. A high phenol index was measured in the Loire river: catchments were shutdown on 9/06 depriving 200,000 inhabitants of Tours and the adjoining area of drinking water. The water supply was restored in 3 days with a ban however on human consumption for 8 days. Drinking water supply was arranged for 10 days. Material damage and operating losses of the company stood at 45 MF and 8 MF respectively.

The chairman of the company was given a 1-year suspended sentence and fined 120,000 F while the plant manager received a 6-month suspended sentence and was fined 60,000 F. The damages to be paid to the civil party stood at 800,000 F.

The accident resulted from a major organisational failure (absence of safety policy, incomplete procedures, etc.).

         **ARIA 2257 - 04/08/1990 - 76 - PETIT-COURONNE**

19.20 - Manufacture of refined petroleum products

        An explosion occurred around 1:00 am in a single-family dwelling. On their return from a trip, the homeowner by drawing hot water from a tap caused the water heater to turn on, causing ignition of the hydrocarbon vapours that had accumulated in the basement when the house was closed. The owner was slightly injured and the house completely destroyed.

Hydrocarbons had been found in the groundwater dating back to 1985; as of 1989, their presence led to the detection of odours in the town. Expert evaluations conducted since 1987 enabled identifying the polluted zone and assigning responsibility to the refinery located 2 km away. A drinking water catchment had to be shut down in 1986 and pumping in the aquifer was already underway prior to the explosion.

On August 23, 1990, a leak was identified at the level of an elbow on an underground line that had been conveying premium grade fuel from the refinery, after having previously transported products of the type containing diesel fractions and turpentine.

According to experts, several factors would have contributed to line corrosion :









- the ground was composed of clayey fill with many sharp-edged rocks (flint), some of which made an "imprint" into the pipe lining, each time initiating additional corrosion. The pipes sat on steel rods, a configuration that was capable of prematurely deteriorating the pipe lining.

- earth removed from the site revealed a very weak concentration of chloride along with a considerable presence of phosphate and sulphate ions, which increased soil conductivity









- the punctured line and its neighbouring lines were influenced by the cathodic protection of lines located in the vicinity, thus increasing the speed of corrosion at those spots where the tube was uncovered.

The surface area of the polluted water table was estimated in 1989 at 100 ha, with the loss of over 15,000 m³ of hydrocarbons and more than 13,000 m³ pumped into the groundwater. The refinery operator settled with all third parties who sustained damages: the owner of the destroyed residence, the water supply distributor, and the municipality. The total cost of compensation paid out plus ancillary works exceeded 50 M francs (in 1991 currency).

Subsequently, a campaign was launched to inform residents, sewer network operators and the various utilities of the risks incurred both adjacent to the pipes and inside underground premises. The operator proceeded with a leak inspection of all tanks containing light products and all underground pipes at the refinery ; no other leak was found as a result of this follow-up inspection. The refinery operator decided to reroute all buried pipes aboveground or into ducts feasible for inspection, in addition to allocating the resources necessary to absorb pollution. A BTEX monitoring network was set up to focus on the municipality's professional premises and residential units. Lastly, the cellars of exposed dwellings were caulked.

         **ARIA 4225 – 13/01/ 1993 - 07 - LA VOULTE-SUR-RHONE**

49.20 - Rail freight transport

        Subsequent to axle failure on a tanker car travelling in a 20-car convoy, 7 railcars each carrying 80 m³ of gasoline derailed around 11:30 pm ; 4 cars were heavily damaged and spilled their contents. An intense fire then broke out. 15 to 20 minutes later, the shell of a railcar suddenly burst completely open, causing an explosion and forming a fireball. Streams of ignited fuel spread over the ground and reached the closest dwellings 20 m away along the lower slope of the rail tracks, creating a succession of explosions in the sewer system.

A 600-m safety perimeter was set up and nearly 1,000 residents had to be evacuated ; 6 individuals were hurt and 15 dwellings destroyed along with 15 vehicles. The stormwater pumping station located 250 m away was damaged by the sewer explosions. Total property damage amounted to over 70 million francs, including 15 million to rebuild the station and another 5 million allocated to pollution cleanup.









Within a few hours, 16 piezometers had been installed : regular soil sampling confirmed the presence of soil pollution as a result of spilled hydrocarbons (quantity estimated at 100 m³ unburned out of the 300 m³ spilled) ; 2.6 ha of land were contaminated, as were a number of farm wells due to water table contamination. Major pollution cleanup work was undertaken by relying upon the venting technique (involving a soil pressure release). Recovered hydrocarbons were incinerated in 2 mobile units fitted with a catalytic bed oven. Some 100 local residents had to be housed elsewhere during the pollution cleanup effort, which would last 4 months.

In addition to proceeding with the initial series of emergency measures, the issue of limiting the spread of hydrocarbon pollution to the subsoil and sewer system was quickly raised. The various parties (municipality, rail transport company and administrative authorities) had to act with urgency in deciding how to evaluate pollution extension in the most timely manner, as well as the severity of consequences experienced and anticipated. Speedy action was also required to implement measures preventing hydrocarbon propagation, though clear lines of responsibility had not yet been established and no estimation of either the duration or cost of these measures was yet available.

Subsequent to this accident, the transport company created an internal unit assigned to improve the response to accidents involving hazardous material transport.

         **ARIA 13050 - 19/06/1998 - 01 - AMBERIEU-EN-BUGEY**

10.13 - Catering / preparation of meat-based products

        A catering facility (handling 35 tonnes/day), in the process of obtaining administrative authorisations, ignited (due to flames or a short circuit?) around 1:10 pm at the periphery of an industrial zone. 4,000 m² were destroyed within 17 min, followed by another 15,000 m² of building space and refrigeration units (containing F22 refrigerant) within 2 hours, despite the quick emergency response (7 min after the alarm sounded) that deployed considerable hydraulic resources (including 13 large hose nozzles and 3 smaller ones). A firewall protected the site's administrative premises. Both the magnitude and speed of this conflagration, followed by fears over toxic emissions, complicated relief efforts. A thick smoke made it harder to locate the fire sources, yet the refrigerants (glycol water, R22) were found to exert no influence. The fire extinction water (max. 450 m³/h) ran off into a stormwater overflow basin following melting of the PVC stormwater downpipe. The fire was controlled around 3:50 pm, with the announcement of complete extinction at 8 am the next morning.

The body of an asphyxiated subcontracted welder was later found in a hallway, and the remains of 2 employees were identified on the mezzanine above the cold storage rooms ; 8 employees sustained injuries. Court-mandated expert appraisals slowed the clearing of debris, and 500 tonnes of meat had to be removed from the rubble within a few days. Nauseating odours were noticeable 1 km from the accident site (businesses and residential buildings 500 m away). Total damage was assessed at 61 million francs; 110 of the caterer's 140 employees were made redundant. The site, which had already experienced 2 smaller fires, would close definitively a year later.

The rapid propagation of this fire, coupled with difficulties during emergency response, offered a number of lessons : delayed notification (18) due to the absence of a sound alarm; late discovery of the incident (lunch break, smoke alerting neighbours) ; and inappropriate means of communication (a phone line on the premises without access to the public network, switchboard

closed). The type of construction, with two interconnected frames (sandwich panels / cladding and roofs) and no smoke vent, causing confinement of heat and radiation in the double-wall enclosure, prevented the exhaust of hot gasses. A nonexistent / insufficient partitioning and heavy reliance on polyurethane foam (M1 or M2?) for wall/ceiling panels, whose resistance was limited to 300°C, raised the thermal load in generating hazardous gasses and volatile matter, thus fanning flames that were spreading "like blowtorches through the walls". Other exacerbating factors included: the collapse of structural metal components due to fire, molten roof bitumen (from a steel panel tank) that poured and burned, suspended ceilings complicating access to large isolated areas under the roof, and high-capacity freezing chambers. The thermal loads varied considerably (e.g. conditioning materials), and the inflammation of frozen merchandise was triggered by cold temperatures that dried contents. A high filling rate proved bothersome and the stacking of racks created a "chimney effect".

     **ARIA 17115 - 20/01/2000 - 63 - CLERMONT-FERRAND**

22.11 - Production and retreading of tyres

In the basement of a 16,000-m² building of a tyre manufacturing plant, 3,000 m² of synthetic rubber (839 tonnes of butadiene/styrene, including 649 tonnes spread with petroleum oil and 1,170 tonnes of polybutadiene) combusted. At 4:40 pm, the alarm was sounded by an agent working for a subcontractor working on the ground floor. At 4:50, a heat alarm triggered the plant's internal emergency plan. An initial assault on the fire at 4:55 pm by onsite fire crews proved ineffectual. The first responders only arrived around 5:40. The fire source, which was difficult to access, had already extended too far and within a few hours the fire had spread throughout the building. At 6:12 pm, a "deluge" type spraying was partially turned on for the basement (1/3 of the floor area), since the other valves remained inaccessible. A number of explosions occurred and 9 fire-fighters were injured, in particular while attempting to activate the rest of the building's sprinkling network; a total of 1,400 tonnes of rubber had ignited, while 1,100 tonnes could be protected by the sprinkling system. Rubber pyrolysis continued for 44 hours, with the heavy smoke emitted necessitating the staggered intervention of 500 fire-fighters. On January 22nd around noon, it was announced that the fire had been fully extinguished. Property damage was extremely high, and the burned building had to be demolished.





This fire would have been caused by a molten metal spark during works using a blowtorch on the ground floor by a subcontracted employee who had been granted a hot work permit.

The analyses conducted during the fire on the quality of atmospheric air and the fire extinction water not captured and discharged via the plant's output channel did not detect any extraordinary rise in pollutant levels traditionally sought (dusts, SO₂/chemical oxygen demand (COD), suspended solids (SS), etc.).

On February 4th, the operator confirmed that 60 tonnes of a vulcanisation compound (vulcanox), along with 900 kg of cobalt hydroxide and 5.8 tonnes of rosin, also burned during the fire. Given the potential environmental and health risks, a major impact analysis and evaluation campaign was launched, under the supervision of a college of experts assembled on July 6th.

Apparently, a significant quantity of vulcanox had made its way into the sediments of both the BEDAT and MORGE streams, in addition to metals and polycyclic aromatic hydrocarbons (PAH). Environmental monitoring was also conducted. On April 27th, 2001, the college of experts completed their study of results from the most recent set of analyses and concluded that the environmental impact seemed to be small.

The operator updated the site's safety report by incorporating domino effects and third-party expertise. This accident underscores the importance of: adapting fire protection resources (water, emulsifiers), appropriately designing retention basins, and acquiring up-to-date knowledge of stored hazardous products (type, quantities). The constitution of a college of experts can serve to facilitate analysis and communication during post-accident monitoring.

     **ARIA 18379 - 01/08/2000 - 95 - MARLY-LA-VILLE**

52.10 - Warehousing and storage

Within a warehouse composed of 8 storage units rented by 4 different operators, fire broke out in bales of cellulose wadding stored in one of the units, while another occupied by the same operator was used as a workshop for sanitary paper products. The accident occurred subsequent to works carried out with a blowtorch on the roof of the building.

Employees arrived on the scene with a fire hose cabinet; however, in 20 minutes, the fire had spread via the roof and existing wall openings to the second unit occupied by the operator. The partial collapse of a partition wall allowed the fire to spread to a third unit occupied by another operator, where agro-pharmaceutical products and animal feed were being stored.





Despite water supply difficulties, external fire-fighters were able to control the blaze in 2 hours; 37 members of the fire-fighting crew experienced discomfort due to smoke inhalation and 7 were hospitalised for testing. The other five units were preserved thanks to the intervention of emergency services. Onsite property damage was estimated at 15 million francs (Euros2.29 million).

During the emergency response, a total of 1,500 m³ of fire extinction water carrying phytosanitary products, detergents and soaps were collected in a permeable stormwater overflow basin, polluting the basin's underlying ground and threatening an aquifer and potable water catchments.

In light of the refusal of the various operators to comply with prescriptions set forth in successive prefectural orders issued following the accident and the litigation proceedings initiated, requisition measures were adopted in order to quickly resume the pumping, storage and treatment of fire extinction water, as well as the installation of 2 piezometers to monitor the water table.

The requisition of subcontractors made it possible to complete the necessary works, with treatment extending over 11 months. The definitive financial settlement of operations was overseen by the party or parties responsible for the accident and its consequences, with their delays only serving to increase the total cost of required operations.

The quick spreading of this fire recalls the importance of a well-adapted construction code and the need for impermeable retention basins (whenever applicable) by unit / operator (depending on the products stored). Moreover, in a configuration featuring interconnected installations run by different industrial operators, it is critical to verify that all technical and organisational questions related to pollution and risk prevention have been addressed by appropriate measures, whose implementation has been clearly assigned.

     **ARIA 20493 - 18/06/2001 - 02 - VENIZEL**

17.12 - Paper and cardboard manufacturing

A fire broke out around 2:50 am in an electrical utility room at a paper mill. Engulfed in the flames, four transformers emptied entirely and a fifth halfway, dispersing a dielectric containing PCB. A prefectural order motivated by a proposal from the inspection authorities for classified facilities was issued given the risk of contamination by dioxins and furans generated during the fire. The order commissioned investigations to determine the extent of contamination and shut down the facility. The re-commissioning was subject to the operator producing supporting documents and authorisations provided for in the prefectural order.



A total of 96 individuals present at the time of the accident (including fire-fighters, employees, journalists and neighbours) had to undergo epidemiological supervision for a full year. The trajectory of smoke led to delimiting a 2.5-km cone-shaped zone for future monitoring and a ban on consuming plant products. About one hundred samples of soot, building materials, soils, water and plants revealed the presence of dioxins and furans at higher concentrations near the site of emission.

A prefectural order dated 4 July 2001 set forth conditions for the partial and gradual re-commissioning of the facilities (stripping of soil and cleaning) and imposed identification and closure of all onsite PCB facilities within a year.







Taking into account the 3 series of analysis on plants, soil, water that revealed PCB and dioxin levels within the daily admissible limits, the ban on exterior land was lifted 25 days later. The quantity of PCB lost equalled approximately 600 kg (of the 2,800 kg initially included), and the quantity of dioxins emitted was 13 kg. The building that caught fire was completely destroyed, with damages estimated at 15.2 million euros. The fire may have resulted from a short-circuit or the poor condition of an electrical component. The "transformer fire" scenario had not been investigated in the safety study.

In all, 26 transformers containing PCB were gradually removed from the site until August 2002. Despite the initiatives taken by the inspection authorities for several years, the removal of transformers damaged by the fire and the stripped soil was still being finalised in summer 2008

The management of the accident also highlighted the need of close consultation between the various departments of the national authorities, a real-time communication for the various players involved, as well as follows up of the actions taken by the operator.

       **ARIA 21329 - 21/09/2001 - 31 - TOULOUSE**

20.15 - Manufacturing of nitrogenous products and fertilisers

       Between 20 and 120 tonnes of a stock containing more than 300 tonnes of ammonium nitrate refuse detonated in a fertiliser plant. The causes and circumstances surrounding the accident would give rise to several investigations and expert appraisals during the following months. Over a 250-m² floor area, the depot formed a band 25 m long, 8 to 10 m wide and 2 to 4 m high. The explosion, whose epicentre was







located at the centre of the pile and corresponded to a 3.4 magnitude earthquake on the Richter scale, could be noticed up to 75 km away. Its intensity was evaluated as equivalent to 20-40 tonnes of TNT.







At the time of the explosion, 266 plant employees and 100 subcontractors were working onsite; 21 deaths occurred at this facility. Five of the casualties (including temp personnel) were working for subcontractors and 5 others were performing a range of onsite activities (delivery, elevator repair, etc.) or just passing by; 1 was assigned to the SNPE site and 9 were located outside the facility (including 2 in a hospital setting), all of whom were killed either immediately by the explosion or over the following days. Moreover, 29 serious injuries were reported, with 21 of the injured requiring hospital stays of a month or longer (300 victims remained in hospital for over 6 days). A Gallieni High School student died 500 m from the epicentre when a concrete structure collapsed, and several others were hurt. Two deaths occurred in a vehicle maintenance facility at a distance of 380 m, and another death was reported in the building of a supplier 450 m from the blast. Thousands of people in the vicinity would require hospitalisation. On October 17th, 2001, the Haute-Garonne Prefecture tallied a total of 2,442 individuals affected by the accident. Property damage to the plant was considerable: a crater over 50 m long and 7 m deep occupied the spot where the depot once stood; 80 ha of the plant were largely devastated.







This facility and 5 nearby chemical sites also affected by the accident were required to suspend activities and ensure safety at their respective locations, by disposing over the course of a few months their inventories of hazardous products; 1,300 other firms, combining industries, retail businesses and the building trades, affected to varying degrees (accounting for a total workforce of 21,000) were gradually inventoried over the subsequent weeks. Within a 3-km radius, 26,000 dwelling units were damaged, including 11,200 seriously, and more than 1,200 families had to be relocated. Tens of victims whose blown-out windows at their homes had still not been replaced would be exposed to cold winter weather 2 months hence. Insurance companies assessed overall property damage at between Euros1.5 and Euros2.3 billion. In July 2006, 758,000 m³ of ground were excavated for treatment; the operator estimated the cost of site dismantlement and pollution cleanup at Euros100 million. Between October 17th and 19th, 2001, several tonnes of ammonia effluent poured into the Garonne River and wound up causing pollution over a 1.5-km stretch killing some 8,000 fish.

       **ARIA 23839 - 17/12/2002 - 68 - CHALAMPE**

20.14 - Manufacture of other basic organic chemicals

       During efforts since the previous day to locate the source of a pressure drop on the cyclohexane supply line of an olone production facility, a leak of this substance was discovered at a chemical site. The substance, used in large quantities, is of relatively low toxicity, although it is a pollutant and flammable.







       Stored in a 10,000 m³ reservoir, the cyclohexane is supplied to the olone and adipontrile (ADN) facilities by a partly common pipeline. Maintained at the proper temperature by a steam system, the cyclohexane is transferred at 20°C and at 2 to 3 bar through lagged overhead or underground piping. With an output ratio of 266:1, 2 pipes, 100 and 40 mm, provide a continuous supply to the olone shop and a discontinuous supply to the ADN shop.







       According to the operator, the leak occurred from the rupture of the ADN shop's 40 mm pipe due to the dilation of liquid cyclohexane in the overhead part of the pipe between two blockages of crystallized cyclohexane. A malfunction of the pipe heating device (T < 6.5°C) led to the formation of blockages, with the cyclohexane then reliquifying primarily in the section the most exposed to the outside heating. As the piping was not yet equipped with a device for rapid leak detection, it took 30 hours to determine the cause of the pressure anomaly. The operator initially estimated the leak at just a few m³ of cyclohexane, then between 850 and 1,200 t in the following weeks, the vast majority had migrated into the ground. A few days later, core samples taken at a depth of 13 m (the depth of the water table) showed the presence of a layer of cyclohexane localized near the site of the leak; lowering of the water table by one of the wells of the site's hydraulic security barrier would have limited the spread of the pollution. Analyses of the water table off site showed no trace of cyclohexane above the drinkability threshold.

On July 2, 2003, 420 t of cyclohexane were pumped from the water table and 16 t extracted from the ground through venting techniques... In July 2004, 590 t of cyclohexane had been recovered, although cleanup operations had slowed considerably since the first of the year, with the quantities of cyclohexane recovered stabilising around ten tonnes per month. Consequently, a Prefectural order was issued July 28, 2004 to request that risk analysis be conducted within the scope of a remedial plan.

       **ARIA 30269 - 27/06/2005 - 34 - BEZIERS**

20.20 - Fabrication of agrochemical products





       A fire was reported at 3.05 am, during the night from Sunday to Monday, in one of 4 buildings (A/B/C/D) adjacent to a SEVESO site producing agro-pharmaceutical products (powders, granulates) and storing finished solid and liquid products. The installations were shut down at the time of the accident. Less than





       an hour after conducting his round, the security guard sounded the alarm upon confirming that there was a fire in zone D1. The executive on duty and the director made their way to the plant. The firemen noted that 3 of the buildings

were on fire upon their arrival at 3.27 am. The utilities were disconnected and the internal contingency plan was initiated, followed by the special intervention plan at 4.22 am. A confinement perimeter of 400 m was set up around the site. A flour silo and lightweight structures were sprayed with water to protect them. The fire extinction water (500 m³/h) was recovered in a retaining basin at the lower portion of the site through the use of inflatable balloons. Following a malfunction of the lifting pump, part of the fire extinction water was pumped and removed by trucks from a specialised company or transferred to a hermetic reservoir (10,000 m³) provided for this purpose after a mobile backup pump had been set up. Roughly one hundred firemen brought the fire under control by late morning; 5 had been injured or otherwise effected (burns, nausea) during the operation. The 4 buildings (7,500 m²) and a stock of 1,700 tons of phytosanitary products were destroyed. Property damage and operating losses were estimated at 40 M euros. A sharp odour was noticeable several dozen kilometres away, and 3,000 people were invited to stay at home or their place of work. The smoke caused discomfort among the residents and personnel of companies in the industrial estate. An analysis of the smoke revealed the presence of sulphur compounds (H₂S, CS₂, SO₂) and HCN. Although the concentrations of CS₂ exceeded the toxicity level (OEL 10 ppm) above the fire, none of the various pollutants exceeded the level at the site's borders. Several companies within the industrial estate had to suspend their activities on the day of the accident. The firemen monitored the slow combustion of the chemical products with the release of fumaroles for several days. A mobile measuring station located 200 m downwind from the site monitored the concentration of sulphur products in the air. As the cause of the fire was unknown, a judicial inquiry was conducted and the insurance company appointed a claims expert. The Prefectoral Order of June 29th suspended operations at the site and required that all safety equipment be overhauled prior to the restart of all equipment not damaged in the fire.





     **ARIA 33299 - 30/07/2007 - 42 - RENAISON**





10.72 - Manufacture of biscuits, rusk and hard baked goods

    A fire broke out at around 2.00 am in a 10,000 m² cake and confectionery manufacturing plant. The video surveillance company informed the maintenance manager. Around hundred fire-fighters arrived onsite with 27 fire engines. The fire-fighters cut off the gas and electricity supply, stopped traffic in the D9 by-road to pump water in a pond and brought the blaze under control at 6.00 am. Fire-fighters stayed back to monitor for any possible restart of fire. The mayor and staff from the press were on site. The retention tank and the pre-treatment station were full and thus could not hold the 200 m³/h of fire water. This flowed outside the site into a canal receiving rainwater from the site that drained into the OUDAN River. The rescue services set up a straw-bale dam. 90% of the plant was destroyed especially due to the presence of significant amounts of combustible material (sugar, flour, carton, etc.). The cooling units, functioning with R404a (mix of fluoroethanes) were impacted releasing hydrofluoric acid but the stocks (silos) of 60 m³ of sugar and 65 m³ of flour along with the hydrocarbon tanks and the site's transformer remained intact. No victims were reported but the accident resulted in the technical unemployment of 120 people. On 01/08, the public water body management and surveillance authority detected no immediate impact on the canal. Appropriate resources will be deployed to treat the debris. The soot and other material generated by the fire fell onto the neighbouring gardens and fields in a 3 km wide and 6 to 10 km long lane causing worry to the residents. The inspection authorities for classified facilities ordered the operator to carry out quality surveillance measurements in the zone south-east to the site likely to the impacted (total hydrocarbons, PAH, halogenated VOC, heavy metals, dioxin ...). The results of the analysis of the soil and plants for human and animal consumption indicated levels below the threshold values but the canal water and sediments were contaminated by dioxin, PAH and heavy metals (Arsenic, lead and Zn). The results of the analysis carried out in January 2008 showed that the pollution of the water body, due to the fire of the plant, was cleared and that some of the pollutants detected previously are part of the background of the environment. The operator drafted a plan to assess the pollution impact on sediments and assess the environmental quality around the production site. The safety studies of the site did take into account a generalised fire in the site and planned measures to promptly control the fire which was not the case (15 h to extinguish the fire). The factory is rebuilt at the same place 18 months later at a cost of 15 Meuros: the establishment is equipped with a fire detection, sprinklers and a much bigger retention for firewater (840 m³). A short circuit in an electrical cabinet (installed in 1980) has triggered the fire.

     **ARIA 34351 - 16/03/2008 - 44 - DONGES**

19.20 – Oil Refinery

    While loading 31,000 m³ of bunker fuel in a ship, a leak in a refinery transfer hose resulted in a major oil spill in the Loire estuary.

    At 4.10 pm, a person on a barge observed the presence of hydrocarbons on the water surface and sounded the alert. At around 4.45 pm, a roundsman identified and isolated the leak at 500 m upstream to where the hydrocarbons were detected.







The internal contingency plan was triggered at 5.00 pm and the inspection authorities of classified facilities were informed. A recovery ship was stationed at the mouth of the river while two trawlers recovered hydrocarbon pellets from the river. The public ban on access to several beaches and fishing in the river that was in place subsequent to the spill was gradually lifted between the 4 and 18 of April. Over 750 people were involved for three and a half months in cleaning up the 90 km of polluted banks (6,170 tonnes of waste recovered and stored onsite before disposal). The operator bore the cost of 50 M euros to cover for the damage incurred, clean up and compensate effected businesses. Investigations revealed that the leak was detected only after 5 hours leading to 478 tonnes of fuel being spilled of which 180 tonnes flowed into the Loire estuary.







A 16 cm² longitudinal breach caused by corrosion localised under the insulator was observed upon examination of the hose. The corrosion resulted from a water leak in the vertical pipe. Water seeped beneath the insulator, caused corrosion and subsequently caused the fuel pipe to rupture. Despite several defects detected the previous month on the same rack, the operator failed to revise this inspection programme to take into account the specific risks presented by this line given its proximity with the river banks. The effected fuel line was completely stopped and the inspections on the entire rack revealed several corrosion points on other lines that required repair.







The operator was required to implement several additional initiatives and measures :







- Extending inspection operations to other pipes in the site along with measurement of thickness at sensitive points (supports, spurs, etc.)
- Moving the layout of the service water mark so that it is not in a vertical position with respect to the insulated pipe
- Using a leak detection system along with a remote alarm in the control room to constantly monitor pipes located near the river
- Modifying the ground below the rack to channel any accidental spill to an adapted recovery network
- Installing a device to monitor the quantity of products leaving the tank and entering the corresponding transfer hose

It was also planned to consolidate the available emergency measures in the event of accidental pollution of the Loire river.

      **ARIA 34893 - 15/07/2008 - 68 - GEISPITZEN**
35.13 - Electricity distribution

      A transformer exploded and ignited at 10:15 am, causing projections around the room and an oil spill that partially flowed into the municipal sewage network via gutters. Neighbours notified local fire-fighters, who were on the scene by 10:30 with their standard emergency equipment. A CMIC unit specialised in chemical emergencies had the fire under control 10 min later using a powder extinguisher. Rescue crews noted the presence of oil on the pavement and in a storm drain manhole that was poorly maintained and clogged; since a risk of overflow was feared, another CMIC unit called in as a backup pumped 50 litres of oil into the manhole. As opposed to the first agents onsite at 11:05, the electricity distribution team did not confirm the presence of PCB in the device that had been operating since 1965. Samples were extracted for analysis, the site was cleaned, and the emergency intervention officially ended at 1:10 pm. For precautionary reasons, doctors examined 15 fire-fighters, 2 witnesses and 2 gendarmes, despite showing no symptoms. A blood test was also administered to each of them the next morning. The presence of PCB was finally confirmed upon the Hazardous Installation inspection at 5:30 pm; the oil contained 89 g/kg of PCB, i.e. a concentration greatly in excess of 50 mg/kg and necessitating the decontamination of equipment. The pumped oil and polluted wastes were transferred and isolated at an appropriate site. In order to prevent against additional pollution tied to PCB, a strip of soil hit by oil spatter was scraped 20 cm deep with transfer onto the same site as the excavated earth and transformer. On July 16, the electricity distribution service performed additional sampling of the polluted pavement surfacing before having it covered with a tarp, while informing the IIC Office of the discovery of an unauthorised white verification tag on the transformer (a yellow tag indicates PCB content, a green one content free), dated 2001 indicating the possible presence of PCB. At IIC's request, dioxin analyses of the soot were carried out on July 17. Since the presence of PCB was unknown at the time of the accident (poor communication between fire-fighters and the site operator), the emergency crews did not take all the effective precautions during their performance onsite: cleaning water discharged into the network, crew members not equipped with adapted protective gear, individuals present on the site (police, neighbours) not removed or evacuated accordingly. Once the presence of PCB had been established, all those exposed to fire smoke received proper care and were placed under medical observation.

      **ARIA 35905 - 02/09/2008 - BELGIQUE - ANVERS**
19.20 – Oil Refinery

      At 11.57 AM a power failure occurred in a refinery. The supply of electrical power was cut off, as a result of the failure of the main power line during maintenance. Because of this the refinery was almost completely powerless, which led to an emergency shut down of the whole plant. The automatically operated safety systems started working : large quantities of products were dumped in the emergency torch and were burnt off. Safety valves opened and released gasses to the atmosphere. Personnel and people working at the refinery were evacuated and only an emergency staff remained at the plant. Information at the central operating desk about what was going on in all the components of the plant was sparse. In the first hour after the incident it was not known which safety valves were opened and which products were ventilated into the atmosphere. That information became available bit by bit during the cause of the afternoon. One of the safety valves that opened released an amount of ca. 70 kg H₂S into the atmosphere. The release point is situated at about 40 m above ground level. After 5 min, the cloud of H₂S formed reaches a downwind distance of about 3 km with a concentration valued at nearly 10 ppm 3 m above ground level. After 20 min the cloud has traveled 14 km and has reached the Netherlands. Concentration levels in the cloud vary between 0.64 ppm at ground level and 0.06 ppm at the top of the cloud at an altitude of about 850 m. Driven by a wind from the south-south-west at 45 km/hr, the cloud proceeds over the western part of the province of Brabant and after about 70 min has reached the city of Dordrecht, 50 km from the refinery. Concentrations of H₂S in the cloud are about 0.06 ppm, still well above the smell detection level . No warning of the H₂S spill was issued, partly due to a lack of information at the plant, partly due to a lack of communication between Belgium emergency services en the Dutch authorities. A population of about 100.000 people was in the path of the cloud and potentially affected by it. An estimated several hundred people were affected by the H₂S and experienced nauseous ness, and respiratory problems. 57 people needed medical care. However the Dutch emergency services were not prepared to deal with the situation, due to lack of information about the event and its possible consequences. This in turn led to insecurity and a loss of confidence in the capacity of the government to deal with incidents like these.



Design, monitoring and maintenance of industrial sludge basins



Massive red sludge release after the failure of a containment dam

ARIA 39047 – 4/10/2010 - Hongrie - Kolontár

24.42 - Aluminium metallurgy

 Around noon, a red sludge basin at an aluminium production site employing some 1,200 personnel broke over a 50-m length, releasing 1 million m³ of highly basic sludge; 10 people were killed and another 286 injured (due to chemical burns and ocular irritation), of whom 121 had to be hospitalised. A total of 284 residences were destroyed and 400 evacuees had to be housed as an emergency measure.

According to the site operator, this sludge contained: 40% to 45% Fe₂O₃, which was responsible for its red colour; 10-15% Al₂O₃; 10-15% SiO₂; 6-10% CaO; 4-5% TiO₂; and 5-6% Na₂O. Moreover, a liquid phase at pH 13 was found, representing 30% of the contents by mass. The Hungarian Academy of Sciences also identified traces of cadmium, chromium, mercury, nickel, lead, arsenic and zinc.

The Hungarian government ordered the plant to be closed, in addition to declaring a state of emergency in 3 of the country's 19 departmental jurisdictions and prohibiting the use of wells, the practice of fishing and hunting, and the consumption of plants and vegetables. According to the Hungarian Interior Minister, the underground water reservoirs were not polluted.

500 members of the police and military forces, wearing appropriate protective gear, cleaned the streets using pressurised water. 23,500 tonnes of gypsum along with 1,800 m³ of acetic acid were poured into the streams in order to lower the pH reading; the construction of 7 artificial dams facilitated the deposition of suspended effluent. The ecosystems of the TORNA and then the MARCAL Rivers were completely destroyed. The countries bordering the DANUBE River were notified on the morning of 5 October; outside of a limited number of dead fish in Komarno (at the confluence of the MARCAL and DANUBE), no noteworthy impact was detected downstream in either Hungary or any of the neighbouring countries.

On 7 October, the leak was sealed, but two days later a village of 1,000 population had to be evacuated and another 5,400 nearby residents were placed on a state of alert following the appearance of a new leak on the effluent basin. A protective dyke was built between the 9 and 12 October. On this same day, the plant was nationalised; production resumed on 14 October.

On the 21 October, the World Health Organisation (WHO) recommended medical monitoring for the 4,000 rescue workers who responded to the emergency call in addition to the cleaning of sludge by specialised subcontractors, for the purpose of avoiding any risks of wider dissemination into the air after drying. The WHO also requested a continuous monitoring campaign dedicated to surface water, air, soils and farm products, so as to evaluate the long-term risks associated with heavy metals being transported by sludge.

1,000 ha of stripped topsoil over a 2-cm depth were allocated to producing biofuels. A dry storage process was implemented inside the plant. All of the country's mining deposits were inspected and their monitoring patterns were clarified.

In its official announcements, the Hungarian government noted an excessive filling of the basins. An NGO circulated photographs dating from June 2010 showing a leak. Local residents filed a class action suit against the operator, who had not drawn up any emergency plans. The operator denied all liability and cited the unusually high quantity of rain that fell during 2010.

According to another environmental NGO, the banks of the DANUBE encompass a good number of waste retention sites in widely varying states of maintenance. In 2000, two accidents, in Baia Mare (ARIA 17265) and Bucharest (ARIA 17425), led to cross-border pollution of both the TISZA and DANUBE Rivers.

Design, monitoring and maintenance of industrial sludge basins

A number of industrial processes introduce basins containing large quantities of sludge or effluent composed of: residue stemming from ore concentrations or transformation, TiO₂ or phosphogypsum production, fines from coal washing or crushed aggregate, paper mill residue, power plant fly ash, refuse from agricultural processing, effluent from starch mills, sugar refineries and other food processing industries.

The combination of quantity and type of materials retained by these facilities, along with their toxic or polluting characteristics and the energy capable of being released in the event of an accident, could depending on basin location generate significant risks for neighbouring populations, local infrastructure, property and the environment. The ARIA database has catalogued tens of accidents with sudden basin breaks or cracks (ARIA 327, [7470](#), 17425, 17265, 19535, 21970, 24363, 26764, 30815, 31750, 34592, 31750, 38590, 39857, 39979, 39983, 39993), chain collapses (ARIA 39857, 39983) and leaks (ARIA [833](#), 11408, 25267, 32403, 39967), in some cases resulting in substantial discharges (ARIA 31750, 39979) sometimes reaching several million m³ (ARIA [7202](#), [12831](#), 21970, 24363, 38590, 39047).

The human toll from such accidents can take dramatic proportions : 488 people lost their lives in Sgorigrad (ARIA 39983), 268 were killed in Stava (ARIA 39857), 125 in Saunders (ARIA 39979), 17 in Miliang (ARIA 31750). The Kolontár accident on 4 October 2010 (ARIA 39047) took the lives of 10 residents and necessitated the evacuation of 8 villages in the vicinity.

Human activity and ecosystems are subjected to damage extending over the medium to long term. Natural habitats in land-based settings (ARIA 17265, 24363, 38590, 39047), including national parks and exceptional nature reserves (ARIA [12831](#)), surface water (ARIA 327, 1625, 1722, [7202](#), [7470](#), [12831](#), 17265, 17425, 21970, 24363, 26764, 31750, 32403, 34592, 31750, 38590, 39047, 39993), soils and groundwater resources (ARIA [12831](#), 17265, 39993) can all be severely affected. Flora and fauna have been destroyed in a number of cases (ARIA 1722, [7202](#), [12831](#), 17265, 39047). River pollution with cross-border impacts have also been recorded (ARIA 17265, 17425). The spreading of sludge has, in some instances, been accompanied by high toxicity levels for human exposure via inhalation of dried sludge dust carried by the wind (ARIA 39047) or via accumulation in foodstuffs. Such circumstances have led to imposing consumption restrictions on water (ARIA [12831](#), 17265, 24363, 31750, 39993) or products from local fishing activities (ARIA [12831](#), 17265, 39047), agriculture (ARIA [12831](#), 39047) or fisheries (ARIA 19535). The sludge discharges might also prevent conducting certain economic activities (ARIA [7202](#), [12831](#), 24363, 39857) and moreover exacerbate situations involving chronic pollution (ARIA 17265, 17425, 39047).

The extent of pollution cleanup work, along with the estimation of compensation for damages rising into the hundreds of millions of Euros, reflects the magnitude of the Aznalcollar disaster (ARIA [12831](#)), which involved the rupture of a storage facility containing several million m³ of toxic sludge.

Potential physical consequences also include residential destruction (ARIA 30815, 31750, 38590, 39047, 39857, 39979, 39983), damage to road infrastructure (ARIA 38590), railways (ARIA [7470](#)) and electrical lines / gas pipelines (ARIA 38590).

Despite the underlying risks tied to the presence of storage basins located adjacent to major population concentrations, several accidents suggest a complete lack of emergency plan (ARIA 17265, 31750, 39047, 39983). And yet such planning is mandatory for: the organisation of emergency response, civil protection and an adequate understanding of hazards before any accident happens, awareness of the protocol to follow in the event of rupture, and lastly a preventive approach towards coordinating emergency response.

Subsequent to the Sgorigrad accident (ARIA 39983), authorities sought to understate the consequences and conceal proof of the accident, yet the town's mayor would later issue a complete account of the disaster.

Observed ruptures or discharges are often the result of organisational dysfunctions :

- during the design phase: inappropriate site location (ARIA 39967) ; inadequate preliminary surveying or a foundation design flaw (ARIA [12831](#), 39857, 39993); mechanical properties of materials used to "lift" the basin enclosure falling short of specs (ARIA 17265, 39979) or changes in these properties as mining operations proceed along the veins; and erroneous structural design (ARIA 31750, 39857);
- during facility construction and operation phase : filling beyond the initially planned capacity (ARIA [7202](#), 31750, 39047) ; poor execution of structural lifting operations (ARIA [833](#)) ; inaccurate management of the hydrological conditions of retention (ARIA 39857, 39993) especially following periods of intense or exceptional rainfall (ARIA 17425, 21970, 25267, 31750) and snowmelt (ARIA 17265, 17425), which are capable of causing overflows (ARIA 4446, 31750, 39967, 39979, 39983) ; deficiencies in regulation systems (ARIA 1722, 15372), drainage devices (ARIA 39857), bypass channels associated with natural watercourses (ARIA 39983); pipe crossing a weaker section (ARIA [7202](#)) ; works performed in the immediate vicinity without adopting protection measures (ARIA 1625) ; and insufficient structural monitoring or maintenance (ARIA 21970, 26764, 34592, 39047, 39993);
- after the shutdown of basin operation (ARIA 31750, 39967).

These deficiencies are also to be correlated with an array of potential personnel changes involving management and employees at the site over the long life cycle of these facilities (ARIA 39857), thereby increasing the chances of losing all or part of the construction and operating records.

A few accidents caused by external forces (e.g. earthquake, hurricane (ARIA 28364)) underscore the need to account for natural hazards, including highly extreme phenomena, in the facility design process.

A large number of accidents have been more readily associated with poor design and operations practices than with the emergence of new technical problems (ARIA 833, 12831, 21970, 30815, 39857, 39979, 39993). Combined geotechnical and engineering knowledge, as well as effective feedback drawn from recent accidents, may be of considerable benefit in improving the level of installation safety: the application of available technologies in as much detail for effluent storage basins as for hydraulic dams would thus lead to undeniable progress. Among the methods currently available, so-called "upstream" construction, which consists of building successive elevations towards the inside of the basin by fluxing them on the settled material, shows greater sensitivity to material composition (ARIA 38590) and drainage efficiency. The "centerline" and "downstream" method overcomes this problem through elevations grounded only on the existing dyke and the natural ground downstream.

Leaks or structural vulnerabilities have been detected in some cases (ARIA 34592), without triggering implementation of required remedial actions (ARIA 17265, 26764, 31750, 39047, 39857), and on a number of occasions without inciting operator response prior to the accident (ARIA 12831, 21970, 39979). Periodic audits or investigations performed by competent technicians, with access to audit results made available to authorities, would lead to :

- improved monitoring of the overall condition of each facility ;
- an assessment of the level of structural stability and safety margin ;
- a continuous adaptation of operating procedures, in favour of integrating progress in structural engineering and technological breakthroughs in the field.

A large number of accidents have involved retention quantities of several million m³ all in the same containment (ARIA 7202, 12831, 21970, 24363, 38590, 39967). Such volumes, often stored in very high basins, present a risk potential significantly greater than what is associated with a partitioned configuration that features several distinct storage capacities.

The rapid succession of several major accidents of disastrous proportions within a few years' time (ARIA 12831, 17265, 17425) led to modifying the so-called "SEVESO 2" 96/82/EC Directive, for the purpose of explicitly including the processing of ores and their associated storage basins. The follow-up 2006/21/EC Directive was devoted to managing wastes generated by the resource extraction industry, implementing the best available techniques identified in the field.



Structural design that incorporates the entire life cycle appears to offer a path towards progress in this area. Such an approach can be based on establishing an effluent retention basin operating plan as of the design phase, describing : the set of structural monitoring and diagnostic procedures, their frequency, the action plan to be implemented when an anomaly is detected and, if applicable, the corrective measures to be introduced, plus the procedures for closing and shutting down the facility. The appropriate emergency measures will also be included in this effort. Updates throughout the life cycle of the structure carefully record each modification introduced, thus enhancing the efficiency of site operators in managing risks.

Accidents whose ARIA number has not been underlined are described on the Website :

www.aria.developpement-durable.gouv.fr

ARIA 833 – 14/12/1993 - 80 - ROYE**10.81 - Sugar manufacturing**

In a sugar refinery, a 12-m high retention dike on a sludge basin subsided causing a leak with a discharge rate of a few m³/hr at the junction between the underlying dike and a newer one built on top. The dike was placed under close surveillance due to the presence of a nearby residential development. This zone of single-family dwellings already had to cope with an accidental spill of distillery residue in October 1972 (ARIA 30815). Fire-fighters performed diving missions into the basin in a vain attempt to plug the leak. An earthen embankment was set up on Departmental Highway 930 between Amiens and Saint-Quentin in order to limit the consequences of an eventual dike break. This embankment maintained in place for several weeks prevented traffic on a specific portion of the road. Local authorities required the site operator to lower the water level in the basin, as a means of mitigating the risks, in addition to performing repairs on the structure. On 17 December, the dike was sealed from the outside, by means of a strut support system, and an 800-m³/h pump was placed online to lower the water level inside the high-risk basin.

 □ □ □ □ □ □ **ARIA 7202 – 19/08/1995 - GUYANA - OMAI**
 □ □ □ □ □ □ **07.29 - Extraction of other non-ferrous metal ores**

In an open-pit gold mine, shortly before midnight a vehicle driver detected a leak on the enclosure of a settling basin for ore processing effluents, as well as a dense cracking pattern at the level of the dyke crest. A bypass channel heading towards the open-pit mine was built as an emergency measure in order to confine 1.3 million m³ of liquid. A total of 2.9 million m³ of effluent containing 25 to 30 mg/l of cyanide reached the OMAI creek, 7 km upstream of the confluence with the ESSEQUIBO River, which was used by the 18,000 residents of the downstream city of Bartica for its fishing resources and water supply. 400 fish were found dead in the OMAI, but none downstream of the confluence. The high flow rates of these watercourses helped dilute the effluent. Maximum cyanide contents of 0.15 mg/l in the OMAI and 0.07 mg/l in the ESSEQUIBO were recorded (in France, the water quality limit for human consumption is set at 0.05 mg/l). The mine was closed. Tanks filled with drinking water were shipped to the site by the Guyana government, which also called upon the international community for aid. An expert from the World Health Organisation (WHO) was dispatched to the scene. Since cyanide is not a bioaccumulative substance, any major health risks appeared to be averted. The OMAI creek was cleaned and the mine remained closed for 6 months, to allow for the broken dam to be secured and to build a new dam upstream.

On 24 August, the leak was plugged, and the operator issued a press release indicating that cyanide content levels observed on 23 August had returned to below 0.03 mg/l.

The retention basin placed in service in 1993 had been built in compliance with Canadian standards of the time. Its design had been approved by the Commonwealth Secretariat after submission by the Guyana government. When the basin broke, the volume of effluent stored was 8 times greater than the maximum specified in the environmental impact study, which served as the mine's sole operating plan.

The type of break observed was unusual: the dam did not fail, yet its clayey core was cracked throughout, allowing the entire liquid phase to flow out and leaving just a very small solid fraction. An assessment committee assembled by the government noted flaws in terms of both design and execution :

- The steel culvert used to channel the natural flow during dam construction had been backfilled without adopting any special measures to prevent flows running along its outer surface. This culvert acted like a drain crossing the dam and in turn compromised its strength.
- The materials put in place downstream of the dam's watertight core did not comply the filter design criterion: the rock filling was too coarse to prevent the sand filter from migrating due to the effect of internal flows. The core was thus subjected to internal erosion, causing a material loss estimated at 2% by mass.
- The rock filling had been covered up downstream of a substantial deposit of low permeability solid and clayey mining tailings, without any structural utility.



Erosion along the construction culvert caused transverse penetration by the retained liquid then accumulating in the rocky filling between dam core and impermeable clayey tailings downstream. In the presence of water, the sand filter underlying the core was dispersed, in turn creating a cavity. Without any support, the core was exposed to tensile stress and cracked.

The replacement dam was built according to a different method, using just clayey materials without any rock filling.

Neighbouring Venezuela, claiming its sovereignty over the 159,000-km² Essequibo territory, criticised the mining and forestry concession management practices adopted by the Guyana government.

 □ □ □ □ □ □ **ARIA 7470 – 10/09/1995 - 46 - SAINT-DENIS-CATUS**
 ■ ■ □ □ □ □ **08.99 - Other extractive activities (not otherwise classified)**





In a quartz quarry, the settlement basin dike wall (base width: 30 m, height: 4 m, ridge width: 10 m) broke for an unknown reason. The dike was fitted with an spillway composed of a rubber mat that prevented the basin from spilling. The accident caused no casualties. Ballast on the Paris-Toulouse railway line was washed away and rail traffic was interrupted for 6 hours. The VERT River was polluted. Both the dike and ballast were restored to their original conditions.

 ■ ■ ■ ■ ■ ■ **ARIA 12831 – 25/04/1998 - SPAIN - AZNALCOLLAR**
 ■ ■ □ □ □ □ **07.29 - Extraction of other non-ferrous metal ores**

The dike on a storage basin for pyrite mining waste broke over a 50-m length following a landslide. 4 million tonnes of acidic water plus 3 million tonnes of sludge containing Zn, Fe, Cu, Pb and As (0.3 g/l) reached the RIO AGRIO River and then the GUADAMAR, spilling over a 200-m to 300-m stretch on a 20-km course. This toxic flow threatened Spain's Donana National Park, surrounding which emergency teams set up earthen embankments. At the same time, local authorities ordered the construction of dams to confine the majority of pollution in the Entremuros Canal (overflows still wound up flooding adjacent farmland); some pollutants reached the GUADALQUIVIR Delta, 80 km downstream of the mine, polluting Gulf of Cadiz beaches. Effluent infiltrated into the water table, which serves as the primary water supply source for both the National Park and the city of Seville. The wastes contaminated 7,000 ha of pastureland and marshland and another 3,500 ha of cropland. This accident caused the death of 30 tonnes of fish, tens of thousands of birds (geese, storks, etc.), 220 kg of shellfish, and frogs, horses and goats. A few people were slightly burnt by the acidic water while trying to save livestock. Hunting, fishing and water consumption (irrigation, drinking water pumping, etc.) were all prohibited for several weeks.

The decontamination process lasted 8 months ; 5 million m³ of sludge and 2 million m³ of stripped farmland were recovered and stored in a former mine. 4.5 million m³ of water held in the Entremuros Canal were treated at a water treatment plant and then discharged into the GUADALQUIVIR. The authorities activated a monitoring and quality restoration plan for the water and soil; moreover, in 2004, they launched a programme to replant vegetation on the affected riverbanks. The ensuing drainage work,

agricultural losses and authority repurchase of contaminated lands amounted to a total cost €240 million. The mine, closed for 12 months subsequent to the accident (500 employees made redundant), was definitively shut down in September 2001. This accident was caused by a 1-m slip of the 600-m², 14-m thick marly plate supporting the dike. A team of university experts uncovered a series of design flaws, in addition to citing the excessive level of basin filling. Several expert evaluation reports had previously revealed (in 1996) vulnerabilities in the clayey underlying ground and dike instabilities. The accidents at Aznalcollar, Baia Mare (ARIA 17265) and Bucharest (ARIA 17425) led to tightening European legislation on mining waste management.

     **ARIA 17265 – 30/01/2000 - ROMANIA - BAI A MARE**

07.29 - Extraction of other non-ferrous metal ores

In a gold tailing treatment facility opened in May 1999, a waste settling reservoir broke after a 25-m long crack formed. A total of 287,500 m³ of effluent containing cyanide (400 mg/l, i.e. 115 tonnes in all) and heavy metals (Cu, Zn) contaminated 14 ha of soil and polluted the SASAR River. A "cyanide wave" 40 km long swept over the LAPUS, SZAMOS, TISZA and DANUBE Rivers. The cyanide concentration reached upwards of 50 mg/l in the LAPUS, 2 mg/l in the Yugoslavian part of the TISZA (on 12 February) and 0.05 mg/l in the DANUBE Delta, some 2,000 km downstream of Baia Mare (on 18 February). Romania, Hungary, Yugoslavia, Bulgaria and the Ukraine were all affected.

High cyanide contents were measured in private wells. Several individuals fell ill. Water consumption and all fishing activities were prohibited. Flora and fauna were destroyed over hundreds of km : 1,200 tonnes of dead fish were recovered in Hungary alone, and thousands of animal carcasses were found (storks, wild ducks, otters, foxes, etc.). Quickly alerted, authorities in countries located downstream were able to take effective preventive measures, including : water releases from dams, notifications circulated to drinking water catchment facilities.

A European expert appraisal (focusing on chemistry, ecotoxicology, biology, process engineering and dam design), ordered by the affected countries and accompanied by WHO representatives, analysed the environmental consequences. Sampling conducted upstream of Baia Mare and then further downstream in Romania, Hungary and Serbia 3 weeks after the accident confirmed the persistence of cyanide pollution in the surface waters of small rivers (SASAR, LAPUS and SZAMOS) and the dilution in watercourses with higher flow rates (TISZA and DANUBE). The impact of this pollution on heavy metal contents in sediments was difficult to determine due to the presence of chronic pollution tied to local extractive and metallurgical activities.

This mission recommended for the operator to: choose a treatment protocol without cyanide, devise backup retention systems, carry out a risk analysis, and review emergency plans in the event of a dam break. All countries affected were also requested to introduce a continuous system for monitoring and detecting the state of DANUBE pollution, along with a protocol for ensuring rapid inter-governmental communication and information sharing with local populations. A French team was assigned the task of evaluating long-term consequences of the accident.

Defects in dam design (excessive proportions of fine materials), unfavourable weather conditions (heavy precipitation and snowmelt caused water level to rise inside the basin and saturated dike components, to a point of weakening them) and organisational deficiencies (lack of an effluent transfer system) all led to the accident. Reasons for the tremendous fish mortality were not clearly identified, though an excessive quantity of bleach may have been used to neutralise the cyanide.





Following this accident, the site operator set up a cyanide effluent treatment plant as well as a 250,000-m³ buffer tank to collect any settling basin overflow prior to neutralisation and discharge into the natural environment. Operations resumed on 13 June as per government authorisation.

     **ARIA 24363 – 29/03/ 2003 - BRAZIL - CATAGUAZES**

17.11 - Paper pulp manufacturing

Subsequent to the break in a storage basin dedicated to discharge water from a paper recycling plant, 1.2 million m³ of highly toxic substances (including lead and caustic soda) spilled into 2 rivers. The layer of spilled products spread 90 km long and spanned 50 km² in the direction of the ocean, threatening an ecological reserve for marine turtles. A thick whitish and nauseating foam covered the north shore beaches of the country's Rio State. The toxic and corrosive substances released caused the death of fish and cattle in addition to damaging fishing boat motors. Due to the risk of population intoxication, drinking water supply was curtailed in the region : 600,000 residents received potable water from tanker truck deliveries.

The site was closed, and the operator (already found guilty in 1995 on charges of pollution and illegal plant operations) was initially fined €15 million despite his attempts to flee justice. Impacts on the environment, human health and the economy were very severe. Biologists concluded that it would take at least 10 years for the ecosystem to re-establish its equilibrium.

     **ARIA 26764 – 20/03/2004 - 11 - NARBONNE**

24.46 - Production and transformation of nuclear materials

Around 11:30 am, local residents alarmed by an unusual noise notified a plant that was producing uranium tetrafluoride from uranium ore: destruction of the dike wall on the No. 2 ponding and evaporation basin 180 m long and 15 m high caused all of the liquid held in the basin to be released, while the solid phase was no longer confined either. 15,000 m³ of process water and 10,000 m³ of sludge heavily loaded with nitrates (ammonium, sodium, calcium) and metal hydroxides (Fe, Mg, Mo, V) spilled in a field some 10-ha in size belonging to the operator, yet without reaching the TAURAN canal or leaving the site. The majority of the discharge remained concentrated in a 4-ha area covered by 30 to 40 cm of material, at the base of basins 3, 5 and 6.

Production activity was suspended. The inspection authority for classified facilities recorded the incident first hand the very same day. On 22 March, the operator undertook construction of a bund wall surrounding the affected zone in order to avoid: sludge leaching, flow into the TAURAN canal, and intensification of the environmental impact.

A prefectural order adopted 23 March ordered: an immediate suspension of all effluent discharge towards the basins; confinement of the damaged basin ; enhanced monitoring of the natural environment as well as surface water and groundwater sources; an expert assessment of basin stability; and submission of an accident report. The temporary sludge retention installation on Basin 2 included, in addition to the first bund wall, a second water-permeable wall that retained sludge below the level of the basin plus a ditch for collecting filtered water through bund walls by means of reinjection pumping to intact basins.

The discharge caused a considerable drop in the hydraulic pressure exerted by Basin 2 contents on the Basin 3 enclosure. This abrupt variation threatened the durability of Basin 3 as well as Basins 5 and 6, which were contiguous. A public agency specialised in dam monitoring, along with 2 consulting firms, evaluated the stability of the entire facility. The monitoring of Basins 3, 5 and 6 by three weekly topographical recordings (16 blocks), completed by inclinometers placed on the dike crest, visual inspection of crack evolution and piezometric readings inside the basins, revealed no potentially harmful movement.

The physicochemical analyses ordered by the operator detected a rise in the rate of nitrates in the TAURAN Canal, with a maximum of 170 mg/l on 23 March before returning to the nominal value of 50 mg/l on 29 March (these levels were deemed

relatively harmless to the environment). The contents of heavy metals (including uranium) were comparable to those observed under normal site operating conditions. The radiological analyses conducted at the parcel boundary indicated an equivalent annual dose generated by the sludge equal to 1 mSv. On 26 March, the operator physically isolated the various zones accessible to the public that were located adjacent to the property boundary.

At the end of March, the operator treated the polluted surface by the use of lime. The polluted sludge and soil were then scraped and placed in definitive storage in Basin 1. On 31 March, a prefectural order authorised the resumption of activity after 12 days of downtime. Since environmental impacts were contained in both space and time, no judicial action was proposed.

Lateral leaks on the body of the dike, composed of tailings from the former sulphur extraction operation, had been detected since 1980, resulting in the installation of a network of drains and piezometers. Impact studies on surface water and groundwater, conducted in 1991 and 1992 at operator request, had concluded the partial permeability of the bottoms of Basins 1 and 2, imposing extensions to the piezometric monitoring network. A follow-up report, dated March 1998, assessed the nitrate-polluted water discharges (77mg/l) of these basins towards the CADARIEGE Canal at approx. 10.5 m³/day: the operator then diverted these discharges into the TAURAN Canal to eliminate the problem of chronic surface water pollution.

The deep cracking of Basin 2 sludge due to the intense heat wave of summer 2003 and heavy autumn rains enabled basin water to infiltrate into the dike body, causing its saturation and a rise in pore pressure, ultimately leading to structural failure. On 15 March, the operator had observed a 15-m long longitudinal crack at the dike crest on Basin 2 and duly informed a consultant, who fearing instability throughout the entire structure had not yet submitted the study's conclusions at the time of the break.

ARIA 28364 – 29/09/2004 - UNITED STATES - LAKELAND

20.15 - Manufacturing of nitrogenous products and fertilisers

When hurricane Jeanne hit, 30 cm of rain poured down onto a fertiliser plant, causing a spill of 15,000 m³ of process water containing small amounts of phosphoric acid. The overflow weir emptied into the adjacent rainwater-filled basin, entering the pits and shafts of former phosphate mines located in the vicinity. Employees built dams and tried to contain and neutralise the pollution before it reached the PEACE RIVER. Samples drawn within a 4-km radius around the plant did not reveal any significant acid concentrations. A manager with the Florida Department of Environmental Protection announced that the pollution had been contained and moreover that any environmental impact had been averted. Authorities however still feared that acid effluent had found its way into one of the mine's drainage pipes left open.

Prior to the accident, the level of process water had been high due to the consecutive sequence of hurricanes Charley and Frances over the previous few months. The operator had already been implicated in another accident during the same month.

Three weeks earlier, in Riverview, 265,000 m³ of acidic water had spilled into a stream leading to Hillsborough Bay, following a dike break. The government's environmental protection agency (EPA) had plans to strengthen regulations regarding management practices for gypsum and runoff water storage.

ARIA 31750 – 30/04/2006 - CHINA - MILIANG

07.29 - Extraction of other non-ferrous metal ores

Near Miliang in Shaanxi province, the dike wall on a storage basin for gold mine tailings broke, releasing water containing potassium cyanide (KCN) into the HUASHUI River, which was polluted over a length of more than 5 km. The tides caused a landslide that destroyed some 20 homes at the foot of the dike and 17 people disappeared. The quantities of KCN spilled were not known.

Since product contents exceeded national criteria, local authorities requested neighbouring residents to refrain from drinking river water, and 5 cities located downstream were ordered to control water quality and organise potable water supplies for all affected residents. According to mine management, the search for the 17 disappeared only got underway 5 days after responding to the water pollution problem. Lime and bleach were poured in an attempt to reduce the cyanide concentrations by their oxidation into cyanate.

ARIA 36208 – 23/04/2009 - 11 - SALSIGNE

07.29 - Extraction of other non-ferrous metal ores

Two landslides occurred on the sides of a 600,000-tonne retention basin for ultimate waste from a former gold mine, upstream of the GOURG PEYRIS River, a tributary of the RIEUSSEC, which empties into the ORBIEL. The retention dike was ripped open over a 25-m length in two spots, leaving solid materials containing arsenic, cyanide, lead and other heavy metals exposed to the open air.

Since the basin had been fitted with an impermeable bottom (geotextile), mining residue (covered with topsoil in order to avoid spreading by the wind) was saturated with water during the heavy rains. Basin contents became heavier, reaching a point of exceeding the basin resistance capacity and causing the failure.

Over the last years of mining operations, the basin had been raised several metres above its original level. A dike was also built down-slope to limit eventual landslides; the dike then had to be expanded following ground movement.

Operations at the ore extraction and processing facility were shut down definitively in 2004. An agreement signed in July 2010 between the site operator and the French government handed ownership of the most polluted parcels over to the government, in addition to assigning responsibility for site cleanup, in exchange for a substantial contribution from the operator. Site restoration was overseen by the ADEME Agency between 1999 and 2008 for an amount in the range of €50 million.

80 years of onsite mining activity had generated long-lasting arsenic pollution (ARIA 4446, 25267) of the soils and the ORBIEL River, whose water was not fit for consumption (affecting a total of 20 municipalities). The sale of thyme and leafy vegetables was also prohibited over an area encompassing 5 towns.

ARIA 38590 – 22/12/2008 - UNITED STATES - KINGSTON

35.11 - Electricity production

Around 1 am, a retention basin containing coal ash from a power plant broke; 4.1 million m³ of sludge (ash and water) spread over a 1.6-km² area with a thickness reaching 1.8 m. The SWAN pond, as well as the EMORY and CLINCH Rivers, both tributaries of the TENNESSEE, and the WATTS BAR Dam were polluted. The sludge wave damaged power lines, a gas pipeline, a road and 54 houses, 12 of which were

entirely covered and another one torn from its foundations. One person was slightly injured; energy production was not suspended, as the waste could be stored in a basin that remained structurally intact.

Utility services were restored over the next few days. The ash, categorised according to local and federal law as "non-hazardous waste", was composed mainly of silica and contained traces of metals and radionuclides. The operator seeded the zones covered by discharge in order to avoid wind dispersion. On 1st January, 2009, an independent laboratory detected in the sampled water at the level of the discharge (both 600 m and 2,400 m downstream) metal contents (As, Cu, Ba, Cd, Cr, Pb, Hg, Ni, Tl) above the thresholds for human consumption.

On 11 May 2009, an agreement between the operator and the national Environmental Protection Agency (EPA) stipulated the pollution cleanup protocol. As a result of long-term impacts feared for human health and the environment, 3.1 million m³ of ash were extracted, then removed by rail and stored in Arrowhead (Alabama); an earthquake-resistant enclosure was built around the damaged basin. According to the operator, the total cost of these measures amounted to \$975 million; during the works, both air and water quality were very closely monitored (with respectively 142,000 and 20,000 samplings over a year).

An international consulting firm commissioned at the start of January 2009 issued the conclusions of its expert evaluation on 25 June, 2009. The basin was formed of an outer enclosure built on the *in situ* clay and filled in the past with ash and later completed by an inner enclosure built by successive lifting steps according to the "upstream" method; the inner enclosure was positioned 70 m inside the outer enclosure. This second dam relied on ash initially deposited in liquid form within the outer enclosure. The *in situ* geotechnical analysis established the presence of a thin layer of atypical sludge vertically aligned with a portion of the inner enclosure lying between the natural clay (alluvial riverbed deposit) and the transported ash. This sludge originated from the direct discharge of ash via a channel in the EMORY River during the first few years of plant operations. A stratified deposit of ash and river sediment with very poor mechanical characteristics (high water content, low shear strength, sensitivity to creep) formed over a 9-cm thick part of the footprint of future retention basins. This deposit's gradual deformation during basin filling gave rise to the break: first, sliding of the north-west portion of the inner enclosure body along a dipping rupture surface upstream of this enclosure; then crossing the 30 m of retained ash and reaching the underlying sludge layer, running parallel to it beneath the inner enclosure body before rising to the surface between the inner and outer enclosures; and finally causing liquefied sludge to be released and the entire configuration to fail.

Leaks observed by the operator at the base of the inner enclosure during the 2003 annual inspection had given rise to repairs of local instabilities and the introduction of a comprehensive drainage system on the enclosure body. Subsequent to the new instability identified in November 2006, this protective system had to be completed by drains on toe of the dam, along with drainage shafts and structural reinforcement of the base using riprap and 30 piezometers.

In August 2009, the operator had a future plan of storing wastes from this plant in dry form, as this technique had already been used at 5 other of its sites. The operator conducted an audit of all the other plants owned featuring a similar design.

On 30 November 2009, a committee of experts appointed by the State of Tennessee underscored the lack of design studies during the sequence of basin rises as well as the operator's poor knowledge of material characteristics and facility operations. The committee recommended stopping construction upstream and applying hydraulic dam regulations to the effluent storage basins; moreover, it judged the emergency plan implementation as reasonably efficient.

The operator was quick to communicate on the measures adopted following the accident via the press and, between February and December 2009, purchased 150 of the polluted parcels.

 □ □ □ □ □ **ARIA 39857 – 19/07/1985 - ITALY - STAVA**

08.99 - Other extractive activities (not otherwise classified)

 ■ ■ ■ ■ ■ Around noon, two 30-m high tailing retention basins associated with the extraction of fluorite and located one on top of the other broke. A 180,000-m³ wave of effluent containing 95% water swept through the valley all the way to the AVISIO River, submerging within just a few minutes the villages of Stava and Tesero, killing 268 people and causing damage estimated at €155 million.

 □ □ □ □ □

 ■ ■ ■ ■ ■ A commission of experts assigned by Italian judicial authorities to determine the accident causes examined and rejected the hypotheses of earthquake activity or an explosives blast at one of the many mines in the region. During normal operations, the water contained in basin tailings is collected from within for discharge via a drainage system. The granular phase at the periphery serves to consolidate and reinforce the enclosure. In Stava, discharge was routed through a pipeline running below the basins crossing the body of the retention enclosure. The commission indicated that subsidence had caused the end of one segment of this pipeline to loosen at the level of a previous repair (bypass). The drainage system defect prevented smooth discharge of water and led to an increase in the hydraulic head inside the enclosure body, which was ultimately responsible for the collapse. This defect most likely dated back several months prior to the accident: an opening had formed on the sidewall of the upper basin in January 1985, causing the leak repaired in March. The basins had been entirely emptied in May to prepare for renovation and then placed back into service on 15 July, just 4 days before the accident.

The year's record rainfall (+22% compared to the average of the 66 previous years) and the considerable snowfall of the past winter contributed to the occurrence of this accident, yet neither constituted the primary cause, since structural disorders had been noticed as of January, earlier than either the snowmelt or the major part of the rainy period.

The investigation also revealed design mistakes: excessive sidewall slope (reaching 40° in spots), an overly marshy foundation soil to provide for both good drainage and wall consolidation offering the required stability. A member of the expert commission declared that the structure "had been built to the very limit of its stability capacity, making just the slightest disturbance sufficient to cause collapse. [...] It is actually surprising that the dam had not failed earlier." A study requested by the township of Tesero in 1975 had already pointed to the inadequate real values of factors of safety for these basins.

In 1992, Rome's Supreme Court confirmed on appeal the guilty verdict for criminal negligence and involuntary homicide, issuing prison sentences for 10 individuals, including 8 company executives responsible for operating the site since the upper basin was built, and 2 members of the regional council assigned to oversee mine safety. In 2004, €132 million were paid in the form of compensation to the 739 victims by some of the subsequent operators as well as by the Autonomous Province of Trento.

Following the accident, Italy's legislation regarding tailings dams was strengthened, and the Stava Mine was definitively closed.

ARIA 39967 – 11/09/2002 - PHILIPPINES - SAN MARCELINO

07.29 - Extraction of other non-ferrous metal ores

On 27 August, intense rainfall caused the overflow of two retention basins containing effluent from a copper and silver mine that had been operated between 1980 and 1997 and then abandoned. The structures involved were 120 m high and offered a total capacity of 110 million m³ of consolidated tailings. An inspection noted the state of weir overflow and ensuing erosion, as well as the discharge of effluent into MAPANUEPE Lake and the SAINT-THOMAS River downstream.

On 5 September, the Department of the Environment and Natural Resources (DENR) considered the prospect of a sudden rupture of both dams highly unlikely and, as such, issued an opinion that MAPANUEPE Lake was capable of withstanding the eventual overload caused by the release of a maximum water volume (estimated to equal 9 million m³).

On 11 September at 1 pm, a leak appeared at the level of the damaged weirs, resulting in a small volume discharge of sludge. 250 families from 3 neighbouring villages were evacuated out of precaution, followed by another 750 families on 12 September due to the incessant pounding rains. The operator called another mining company to request substantial backup pumping resources in order to remove water from the basin and thereafter undertook the necessary repair work.

High-intensity rainfall observed during the months of July and August were responsible for a rise in water volume inside the upper retention facility, to a point of exceeding the weir discharge capacity. The mine had been abandoned for 3 years ahead of the initially scheduled date as a result of slope instabilities and annual flooding.

 □ □ □ □ □ □ **ARIA 39979 – 26/02/1972 - UNITED STATES - SAUNDERS**

 ■ ■ ■ ■ ■ ■ *05.10 - Coal extraction*

 □ □ □ □ □ □ Basin 3 at a coal mine broke and released 500,000 m³ of coal sludge (water, dust, clay, lower-grade coal and impurities), which swept away Basins 2 and 1. A 10-m high wave was unleashed, engulfing 16 small towns. 125 of the 5,000 residents affected were killed, another 1,120 were injured and 4,000 left homeless. A total of 507 houses, 44 mobile homes and 30 businesses were destroyed.

 □ □ □ □ □ □ Precipitation had fallen for several days leading up to the accident and caused the rise in water level inside the basins, prompting the site operator to proceed with periodic level recordings every 2 hours, yet without issuing the order to evacuate the downstream population. At 8 am on 26 February, a technician noted that the water level had reached the crest on dam no. 3. Five minutes later, this dam enclosure, which had become saturated with water, failed.

Basin 3 had been built on foundations of coal sludge instead of a soil with the requisite geotechnical characteristics. In 1967, the Department of the Interior had indicated to West Virginia authorities the instability and hazard associated with 30 dams located in this State, including this one (Buffalo Creek). This earlier study had been conducted after the 1966 Aberfan accident in the U.K., resulting in 147 deaths. The Buffalo Creek Basin, built prior to passage of the federal "Coal Mine Health and Safety Act", would not have been approved for construction once this act had been promulgated.

In June 1978, the operator paid \$18.3 million to survivors and another \$1 million to the State of West Virginia following the outcome of an arbitration proceeding (out-of-court settlement between the parties).

 □ □ □ □ □ □ **ARIA 39983 – 1/05/1966 - BULGARIA - SGORIGRAD**

 ■ ■ ■ ■ ■ ■ *07.29 - Extraction of other non-ferrous metal ores*

 ■ ■ ■ ■ □ □ □ □ Around noon, the storage basin for flotation residue at a lead, zinc, copper and silver mine ripped open, releasing 450,000 m³ of sludge that killed 488 as it swept through the village of Sgorigrad below and continued for another 7 km until reaching Vratza, where the central square was covered by 20 cm of sludge. A new basin was built on the opposite valley slope, and the mine closed operations in 1996.

 □ □ □ □ □ □ The basin had been built in 1960 at the same time as the flotation plant by damming a valley using mining tailings. The streams flowing at the bottom of the valley had to be diverted and channelled. Heavy rains combined with a break in the stream bypass canal (though no direct link of cause and effect could be established) caused the basin to overflow, quickly leading to erosion failure.

In the days following the accident, Soviet authorities announced a death toll of 107 and sought to prevent information circulation by ordering the police to confiscate all photographs of the disaster. 40 years later, the Sgorigrad town hall raised the victim count to 488.

 ■ □ □ □ □ □ □ **ARIA 39993 – 16/07/1979 - UNITED STATES - GALLUP**

 □ □ □ □ □ □ *07.21 - Extraction of uranium and thorium ores*

 ■ ■ ■ ■ ■ ■ □ □ In a uranium mine, an effluent retention basin broke. The surrounding retention enclosure subsequently failed, releasing 370,000 m³ of solution and 1,100 tonnes of a radioactive powdery substance. The radioactivity of these released elements (primarily thorium 230 and radium 226) rose to 46 Curie (1,700 Gbq), a level comparable to what was released the same year during the Three Mile Island accident. The solid phase settled in the vicinity of the operator's parcel as well as into the adjacent ARROYO River. The liquid component flowed until reaching the RIO PUERCO River. In all, 110 km of watercourses, including 45 located in the neighbouring state of Arizona were contaminated. The slurry mix clogged sewer systems and left in its wake contaminated puddles.

 □ □ □ □ □ □ Despite implementation of the New Mexico emergency plan, which included extensive onsite sampling, the population was not immediately notified: 2 days after the accident, several individuals sustained burns to their feet after wading in the river as a result of the high level of acidity in the discharged solution. The press reported deaths to livestock. Aquifers also sustained long-term pollution due to high metal concentrations.

A total of 3,500 barrels of waste were recovered. Once the basin had been placed back into service, activity was suspended between 8 and 13 November upon order of the State of New Mexico as a result of noncompliance with minimum clearances (separation between the liquid and the dam core).

Supplies were brought by truck until 1981, especially for livestock feed and irrigation. River water was used once again despite the presence of residual contamination. The mine was closed in 1982 and included in 1983 on the EPA's list of national priority sites, given the migration of radionuclides and chemical compounds found in groundwater.

In January 1980, the Nuclear Regulatory Commission, in a publication filed with the Federal Register, cited a design error (inaccurate assessment of settlement amplitude and heterogeneity among alluvial foundation materials) as the cause of the basin break. These inaccuracies resulted in differential settlements and dam cracking, which were then exacerbated by operating deficiencies: the operator failed to maintain a sufficient distance between the liquid phase contained inside the basin and the dam core, which led to dam weakening due to crack filling and material saturation.

An agreement reached in 1988 between the EPA and the operator imposed that rehabilitation work be conducted by the operator. The water from 3 shallow water tables, polluted by residue from acidic tailings, sulphates, thorium, radium and iron, were pumped via both existing and additional shafts and then routed to the evaporation basins. The compartments of the mining effluent basin were covered by a radon-proof membrane. This process, which enabled limiting pollutant migration in water yet did not sufficiently lower the observed content levels, was revised in 2008. Pollution cleanup processes relying on massive water injection and subsequent pumping are still under study in 2011.



Bringing gas-powered installations back online



Explosion of a superheater within a steam-cracking unit

ARIA 36496 - 15/07/2009 - 57 - Saint-Avoid

20.14 - Manufacturing of other basic organic chemical products

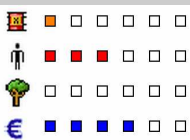

Superheater "A" on steam cracker no. 1 at a petrochemical platform exploded around 3 pm. Of the 8 staff present onsite, 2 were killed and the other 6 all injured. Projectiles, composed for the most part of refractory materials, were sent distances of some 100 metres, with some pieces nearly 50 cm in size landing immediately adjacent to the superheater; a dust cloud formed vertically above the site.

The Internal Emergency Plan was activated, resulting in the evacuation of plant personnel and the arrival of 70 fire-fighters. Of the 6 injured workers (2 of whom were subcontracted personnel), 5 would return home the same evening. No property damage or other impacts were recorded offsite, outside of noise caused by the deflagration. Continuous air quality measurements taken on the aerated zone did not reveal any anomaly. Both the Minister of Industry and the Secretary of State for Ecology visited the site.

Cylindrical in shape, with a diameter of 5 m and some 20 m high, this water vapour superheater, connected to a chimney of the same height via a connecting cone, was holding no toxic products. The explosion was not followed by fire.

Subsequent to violent storm activity during the night of July 13th to 14th, involving water infiltration that affected a utility room and disturbed the Digital Command and Control System (DCCS), steam cracking line no. 1 had been shut down and placed in safe mode.

The start-up procedure for this line had been initiated the morning prior to the accident; this procedure took a long time, as sections were brought back online incrementally.

On July 15th, superheater "A" was reset around 3 pm with the intention of proceeding by a manual restart. A technician arrived carrying an adjustable pole in order to switch on the pilots when the superheater exploded. The bodies of both this technician and a second employee would be found amidst the rubble, due in large part to collapse of the superheater floor.

According to the site operator, two distinct causes were responsible:

- an accumulation of inflammable gas below the flammability limit: the investigations conducted favoured the hypothesis of gas flow in the direction of the burner during both the start-up phase and the actual operation of restoring power;
- ignition of the dust cloud by the adjustable pole or a hotspot located within the superheater's convection zone.

Other ignition sources could be foreseen as well (electric spark, static electricity, etc.), although the two sources cited above would appear the most plausible. Certain circumstances facilitated the occurrence of this accident whose serious consequences were due to the presence of personnel in the vicinity as the superheater was being powered up; among these circumstances are:

- failure to proceed with a vapour cleaning of the superheater prior to restart, in violation of the operating protocol;
- gas inlet via a burner in the absence of a flame on the corresponding pilot;
- the technical safety barrier, according to which it is prohibited to supply burners without a visible flame on the pilot, was not operational. This barrier was composed of an automated mechanism that closed the gas feed valves if the flame detector has not signalled the presence of a flame 10 seconds after valve opening. Following a number of uncontrolled detection alerts shortly after installation, this automated detector mechanism would have been deactivated due to the limited number of shutdowns / restarts planned for the unit over its operating cycle.

Emergency measures were imposed upon the operator, as a precondition of restarting the vapour cracking line, including: submission of the accident report, update of the safety study relative to this part of the steam cracker, certificates of the good state of repair of all potentially affected equipment by a certified inspection body. The operator introduced a servo-controlled, automated function to ensure completion of all restart steps (vapour sweeping, pilot and burner ignition) along with a control panel for initiating the ignition sequence remotely.

Bringing gas-powered installations back online

An explosion at the time of restarting a gas-powered thermal installation can take a dramatic turn, as was the case for the superheater in Saint Avold (ARIA [36496](#)) and its 2 fatalities. Blast, thermal shock, structural collapse, projections of equipment or sizeable quantities of building fragments and materials, as well as broken windows in the vicinity, are the cause of many fatal accidents and/or injuries sustained inside the affected installation (ARIA [164](#), [5132](#), 6082, [6189](#), [9878](#), [26252](#), [36496](#)) or its immediate environment (ARIA [5132](#) / child killed in an adjacent building).

Beyond the human casualties and property damage within the particular plant or workplace, neighbouring installations may also be affected (ARIA [1466](#), [26252](#) / tanks containing inflammable substances, liquefaction units), as well as area dwellings and the overall environment (ARIA [6189](#) / explosion of low-pressure separator inside a refinery evaluated at the equivalent of 90 kg of TNT, perceptible within a 30-km radius, [26252](#) / broken windows on adjacent buildings and shops).

While focusing on just explosion-related phenomena, events recorded in the ARIA database originate primarily from the presence of an explosive atmosphere containing combustible gas within a confined space, in the same building that basically houses the installation or combustion chamber, combined with its sudden ignition in contact with a hotspot.

- **An accidental gas accumulation in a confined space** may be the consequence of a number of deficiencies:
 - organisational and human:
 - procedures not respected and a gas feed line remaining open (ARIA [164](#));
 - insufficient vapour sweeping of combustible gases (ARIA [36496](#));
 - inappropriate valve opening manipulations (ARIA [3212](#), [6189](#));
 - maintenance flaws (ARIA [6343](#), [6560](#), [14666](#));
 - inadequate torque on the flanges (ARIA [32174](#));
 - incomplete installation modifications or failure to follow the acceptance procedure (ARIA [3212](#));
 - non-operational control and safety devices (ARIA [6343](#)).
 - equipment:
 - relief valve (ARIA [6323](#)), solenoid valves (ARIA [3212...](#)), electronic fuel regulation components (ARIA [6537](#));
 - pipelines in open air (ARIA [6343](#));
 - joints (ARIA [6560](#));
 - defective weld or corrosion phenomena (ARIA [1015](#), [14666](#));
 - control devices and automated mechanisms (ARIA [6343](#), [32798](#), [36496](#));
 - poorly-designed safety accessories (ARIA [32817](#) / safety valves).
- **Ignition difficulties** can facilitate the appearance of some of the following:
 - pre-ventilation defects (ARIA [6538](#));
 - excessively low gas pressure at the fuel injectors (ARIA [6347](#));
 - flame detachment during ignition and multiple starts (ARIA [5132](#), [6323](#), 28389, 32175, [36496](#)).

Other types of events have also been recorded such as the sudden vaporisation of heat conductor fluid subsequent to cracks or breaks on heat exchanger bundles inside vapour generators (ARIA [6082](#), [25754](#)).

Accident records also underscore the imperative nature of personnel training regarding the specific risks related to installation start-up (ARIA [6189](#), [6343](#), [6538](#), [24354](#) / technicians' reliance on a "simplified procedure"), the existence of control procedures and guidelines adapted to this transient phase of installation operations (ARIA [32798](#)) include: the creation of an organised monitoring programme for operational deficiencies and preventive/remedial equipment maintenance (ARIA [6189](#)), completion of inspection audits (ARIA [6189](#)), and the improvement of circuit sealant controls and safety accessories (ARIA [32817](#)).

Following the explosion at the Courbevoie boiler room (ARIA [5132](#)) and in taking the known accident history into account, a group of experts conducted a study on feedback specific to the safety of gas-powered boilers. This group's main recommendations and suggestions pertained to several technical and organizational issues, namely:

- installation design and construction (equipment location, assembly quality, placement of cut-off elements, gas detection instruments, etc.);
- installation operations, during normal periods or transient phases, and maintenance (technician awareness of the specificity of risks associated with system restart, strict written procedures and guidelines with close monitoring and control of their narrow field application, practical training and exercises).











The use of supervisory, detection and alarm resources appropriate to the kinetics associated with potential operational glitches, or the blocking or shutdown of sensitive controls, as well as mitigation devices in order to limit accident consequences are also of the kind to limit risks.











Additional references (both detailed reports and summary reports):











- ⤴ ARIA 5132: Explosion of the Courbevoie boiler room
- ⤴ ARIA 24354: Explosion of a gas-fired furnace
- ⤴ Accident data on gas-powered heating installations may be downloaded from the Website www.aria.developpement-durable.gouv.fr - September 2008.











Accidents whose ARIA number has not been underlined are described on the Website:

www.aria.developpement-durable.gouv.fr

          **ARIA 164 – 27/04/1989 - 39 - TAVAUX**
 20.13 - *Manufacturing of other basic inorganic chemical products*
 Inside a chemical plant, an electrostatic filter for removing dust, containing 696 plates sized 17.5 m x 7.5 m x 18 m on a 116-MW coal-fired boiler, exploded. The accident occurred during a restart procedure after a two-week shutdown for maintenance; it resulted from the accumulation of 440 m³ of gas inside the boiler following failure to close the backup burner feed line (300 m³/hr), which had been opened 1 hour and 20 minutes before the accident and which was discovered 90 minutes after the accident. One manual valve and two automatic gate valves stayed open (no visual control of valve position, automated shutoff of gate valves while continuing to inject compressed air, warning message ignored). The explosion caused 1 death and 8 injuries among the technician staff. Shattered window panes and projectiles were observed up to 250 m away. Total property damage was estimated at 20 MF.

          **ARIA 1015 – 20/07/1989 - 13 - MARTIGUES**
 20.14 - *Manufacturing of other basic organic chemical products*
 A boiler built in 1962 that was producing 100 tonnes/hr of vapour at 82 bar and 475°C exploded 3 days after restart following a 3-month shutdown for maintenance. The energy created cut 23 tubes out of the 470 present on the installation (A37 steel, diameter: 63 to 76 mm, thickness: 4-5 mm) less than 20 mm from the lower and upper drums. The screen burst open and was moved. Tube debris and refractory masonry were ejected a distance of 100 m and slightly injured a technician. This accident might have been caused by the simultaneous bursting of several corroded tubes (2-mm diameter) due to acid deposits (composed of metal sulphates), within a heterogeneous overlapping zone, followed by erosion as a result of a perforated tube. The cost of repairs was valued at 15 MF.











          **ARIA 3212 – 08/04/1991 - 71 - LE CREUSOT**
 25.30 - *Manufacturing of steam generators, excluding boilers for central heating systems*
 Fitted with an automated regulation system and continuously operated without supervision since 8 February, 1991, an overheated water boiler (19.2 MW, 160°C, 11 bar) exploded during a manual control phase upon attempting to transition to a boiler with less capacity. The accident was caused by gas accumulation inside the firebox following the untimely opening of 2 solenoid valves in series, responsible for controlling the burner feed line. An electrical short tied to a previous cabling configuration, retained unexpectedly when installing the automated control system, wound up triggering a control relay switch common to both valves. No victims were reported; property damage, though significant, remained confined to the unit in question.





          **ARIA 5132 – 30/03/1994 - 92 - COURBEVOIE**
 35.30 - *Production and distribution of steam and air conditioning*
 An explosion occurred at 1:30 am inside an urban heating plant (500 MW, 6,000 m² floor area), with the energy dissipated into the ground estimated at the equivalent of a 50 kg charge of TNT. Operational since 1987, this heating unit comprised 5 boilers (2 coal-fired, 2 fuelled by a coal/gas mix, and 1 gas-powered). During the previous shift, several attempts to start up one of the mixed fuel boilers failed. Unable to restart the equipment and with the gas inlet pressure gauges indicating zero pressure, the foreman of the night shift ordered opening both valves a quarter turn towards shutting off the gas inlet on the main circuit. Since the indicated pressure remained at zero, the shift foreman requested the boiler technician to open a blowout preventer and then a butterfly control valve to feed the mixed fuel boiler with gas. This operation resulted in a major gas leak. A gas boiler underwent emergency shutdown, and 2 technicians exited the unit to cut the general gas supply at the regulator station, 110 m from the building, when the explosion happened.

One of the 5 employees was killed on the spot. A girl 10 years old living 40 m from the plant died 4 days later due to the injuries she sustained; 59 other neighbours were also hurt. The installation was devastated and nearby districts severely damaged. A total of 600 personnel from local businesses had to be laid off temporarily and 250 residents were displaced from their homes. While awaiting hook-ups to neighbouring utility lines, some 140,000 users and 2.2 million m² of office space had no heating or hot water service. Operations of large-scale computer networks that relied on the plant for cooling, were disturbed. Total damages were valued at 544 MF (or €83 million). Investigation results indicated that 3,750 normal m³ of gas would have been released until the gas utility company was able to cut the supply line 30 min after the explosion.





The defective pressure gauges might have been damaged by a pressure surge occurring sometime prior to the accident. The orders issued by the night shift foreman fell under the exclusive responsibility of the maintenance crew; in case of emergency, plant technicians should have requested intervention from the gas company. The blowout preventer had not been designed for handling within a pressurised environment, and moreover the butterfly valve upstream of the blowout preventer should have been adjusted by the boiler operator while the device had remained in the intermediate position, where it was no longer sealed since the flanges were slightly spaced. The gas cloud ignited upon contact with the coal-fired boiler, which was operating at the time of the accident. No scenario involving a leak and gas explosion had ever been assessed in any of the site's previous safety reports. The risks related to coal dust had not been addressed either. Dust particle behaviour was also likely to have contributed to the strength of this explosion.

On 5 May, 2004, the Versailles Appellate Court magistrate judging the case decided there were no grounds for prosecution.

          **ARIA 6082 – 08/12/1994 - 44 - BASSE-GOULAIN**
 10.13 - *Preparation of meat-based products*
 Inside an industrial butcher shop, a smoke tube boiler set at 1 tonne/hour of steam exploded. According to its specifications, the boiler had a capacity of 2,790 litres, a heating surface area of 27 m² and was burning domestic fuel oil. Installed in 1979 to supply 5 pressure cookers, it had been rated at 10 bar. A whistling sound was heard at the level of the valve assemblies just before the explosion, which blasted the 200-m² building. Three employees were killed instantly (a body was found 250 m away along with the front boiler plate), 3 others were injured, one of whom seriously. The boiler frame (weighing 3 tonnes) was projected 150 m northward, while the firebox tube and a hot water tank landed 200 m to the south. The boiler, which had been off and drained for maintenance (relief valve, drainage tap) 3 days prior, was restarted the very same morning. One possible cause of this accident would have been the untimely and inappropriate filling of the heating unit with cold water, triggering a sudden vaporisation against the heating tube, which had already been heated to high temperature. An expert's appraisal released in 1995 indicated that partial draining of the firebox tube might have led to the observed state of damage strictly from an energy standpoint. This report however did not draw the conclusion that such draining was in fact the actual cause.





     **ARIA 6189 – 22/03/1987 - THE UNITED KINGDOM - GRANGEMOUTH**

19.20 - Oil refining



    At a refinery, a low-pressure separator exploded inside a hydrocracking unit undergoing a restart procedure. The explosion, of a charge equivalent to 90 kg of TNT, was heard and noticed up to 30 km away. The gases and inflammable liquids discharged (1 tonne of hydrogen, 400 tonnes of hydrocarbon) ignited and fuelled a fire that would cover 35,000 m². The human toll amounted to 1 fatality (a technician) and 7 injured. The missile-like effects of the explosion had threatened the safety of 200 people. Property damage was extensive, estimated at €7 million inside the site and another €7,000 outside (broken window panes, damaged roofs, etc.).





The accident occurred while the hydrocracking unit was being reset during a restart procedure subsequent to a routine shutdown. The inappropriate manual opening of a valve between the high-pressure separator (155 bar) and the low-pressure separator (9 bar) caused liquids to be transferred towards the low-pressure separator, whose relief valves had been designed solely to account for the fire risk, making these valves inadequate for the purpose of releasing excess pressure in the low-pressure separator (10 m long, 3-m diameter, 200 kg), which exploded at an estimated pressure of 50 bar. The suspected valve did not close automatically because the level alarm set very low inside the high-pressure separator had been disconnected during a modification carried out in the unit several years prior; moreover, site technicians doubted the reliability of the main level indicator, preferring instead to refer to the backup detector recording table, and it was the misreading of this recording that led them to believe that the level inside the high-pressure separator was normal.

After the accident, several remedial measures were adopted, namely: reconstruction of the unit with correctly-designed relief valves on the low-pressure separator and improved instrumentation; implementation of procedures intended to drain the liquid present in the high-pressure separator during shutdowns; establishment of a system for monitoring flaws and maintenance needs on the equipment and appropriate personnel training; and a more frequent and stringent auditing programme.



     **ARIA 6323 – 29/01/1993 - 92 - CLICHY**





35.30 - Production and distribution of steam and air conditioning

   An operating, gas-fired water tube boiler (57 tonnes/hr, 24 bar) located in an urban heating plant stopped subsequent to an electrical power outage. The other boiler, which was also in service at the time, did not shut down. Following malfunction of the pilot valve on the spring-activated expansion device for limiting ignition circuit pressure, the technician tried 3 times to restore service before pressurisation by adjusting a tap opening and obtaining permission for activation from the control console. While shifting from start-up to normal mode, an explosion occurred shortly after opening the main feed valve. The combustion chamber was totally destroyed, and the roof along with one building wall were damaged, yet no victims were reported.



     **ARIA 6343 – 07/10/1994 - 69 - LYON**

86.10 - Hospital activities

   An explosion occurred on a gas-powered, 20.88-MW boiler operating by means of a remote monitoring system. Following the detection of an operating defect on the generator burner and its safety mechanism, an on-call technician entered the boiler room to perform verification work. The mandatory control devices, which were inoperable, made it impossible to determine the exact cause of the malfunction. The technician nonetheless reset the automated restart sequence; the explosion happened 30 sec after the pre-sweeping function had begun (air injection into the firebox). The investigation indicated the presence of a foreign body (metal and calamine particles) in both the gas filter and solenoid valves on the gas-powered boiler feed lines, with an imprint of the flap gate of the 1st valve (due to a leak?), as well as significant head losses on the pipeline exposed to the open air (22 m long, with twelve 90° elbows). These anomalies seem to have enabled gas to flow into the generator for 30 min following implementation of burner safety measures. The attempted restart by injecting air into the firebox served to reach the upper flammability limit, in turn causing the explosion to occur within the combustion chamber.



     **ARIA 6537 – 07/02/1973 - BELGIUM - FELUY**



19.20 - Oil refining

   At a steam plant, a boiler had been operating in steady state at minimum flow rate, with both gas-powered and fuel oil-powered burners running simultaneously. The mode setting was automated, yet due to a lack of reliability in the measurements of combustion air, both the gas discharge controls and blowing regime were shifted into manual operating mode in order to make adjustments to better meet demand. An electronic component malfunction on the fuel regulation system triggered the regulation valve to fully open, extinguishing combustion and generating a large quantity of unburned fuel, which blocked the flame detectors, thereby causing a general fuel oil and gas supply outage. Since the fan was still running, the unburned fuel reached the upper flammability limit and exploded.



     **ARIA 6538 – 15/06/1972 - Not available -**

19.20 - Oil refining

   In a steam plant, difficulties arose at the time of starting up a boiler. The technician repeated the start-up sequence, yet failed to ventilate the premises sufficiently ahead of time. The air-gas mix exploded upon attempting to turn the boiler back on. The technician was killed and the boiler totally destroyed.



     **ARIA 9878 – 04/09/1996 - 80 - HAM**

24.42 - Aluminium metallurgy



   An explosion occurred inside a natural gas-fired furnace used for annealing aluminium sections. While repairing an adjacent machine, a technician was killed by ejection of the furnace door (weighing 1 tonne) and an electrician sustained serious burns. The roof was partially destroyed by ejection of the upper part of the installation and debris was spread over a 50-m radius. The gas inlet was closed and no fire ensued. A judicial investigation was carried out.

     **ARIA 14666 – 07/06/1996 - GERMANY - GELSENKIRCHEN**



19.20 - Oil refining





   In an alkene manufacturing unit at a refinery, a separator exploded, causing the release of ethane, ethylene, methane and hydrogen, at the time of restarting the deep freeze installation. Other pressurised containers, pipelines, process command and control instruments and metal structures were all damaged. The emergency shutdown system was activated, and the air conditioning device at the recording station was depressurized, drained, disconnected, cleaned and drained once again. Total property damage was estimated at 3 million marks (i.e. €1.5 million).

The explosion resulted from an internal crack (1,600 mm) of the equipment along the weld seam (the base metal was ferritic, while the weld was made using austenitic metal). The corrosion induced by hydrogen also stemmed from start/stop cycles imposed by the production routine. Moreover, a maintenance deficiency could have been the cause as well.



    **ARIA 19155 – 22/10/2000 - 03 - MOULINS**





35.30 - Production and distribution of steam and air conditioning

   A pressure surge, most likely due to an explosion within the combustion chamber, tore off a large portion of the outer lining on a 6.9-MW boiler running on municipal gas in automated mode. The boiler room was protected by cutting the gas supply via the external valve. The fire department was called but did not have to intervene given the absence of fire and no injuries. Three days prior, following replacement of the burner, all safety tests were successfully conducted. The boiler was also being used as an auxiliary to the cogeneration system. The day before the accident, the gas-fired burner was protected following a pressure drop. The sector foreman requested that the cogeneration facility be shut down and that the boiler be allowed to operate on its own. The boiler was restarted around midnight; 2½ hours later, it had to be secured following a problem on the burner. The explosion occurred when power was restored 2 hours after that. An investigation was conducted to determine the exact causes.



    **ARIA 24354 – 01/04/2003 - THE NETHERLANDS - GELEEN**

20.1 - Manufacturing of basic chemical products, nitrogenous products and fertilisers, basic plastics and synthetic rubber





   At a chemical site producing melamine, an accidental explosion occurred during restart of an industrial furnace powered by both natural gas and the residual gas from other units. The filters clogged by residual gas were regularly cleaned, which necessitated installation shutdown and restart. The explosion blasted the cover off the furnace where a maintenance team was working. The cover as well as the personnel fell into the furnace (heated to 350°C). All 3 employees were killed. As a means of shortening this shutdown time, technicians had defined a rapid restart protocol that neglected the site's safety guidelines and indications. This rapid procedure introduced previously consisted of filling the furnace with a stoichiometric mix of gas and air. Mix ignition was likely triggered by a spark emanating from an electric fan turned on by a technician a few moments before the explosion. An investigation was launched to determine the causes of this accident. Property damage and operating losses were estimated in the several millions of Euros.

    **ARIA 25754 – 28/11/1984 - 76 - LE HAVRE**



35.13 - Electricity distribution

   An explosion occurred on a new boiler set up inside a power plant (10 tonnes of steam/hr). This auxiliary boiler had been intended to complement the provision of steam required to reheat the heavy fuel oil used in the Unit 3 burner storage and cooling areas. This was a corrugated firebox tube boiler with 3 exhaust paths. Combustion gases were directed to the back of the boiler and then channelled towards the front via the lower smoke tubes before being conveyed to the chimney located in back via the upper tubes. This boiler was designed to function in a buffer capacity on the network, in parallel with another boiler of the same type (which had been shut down on the day of the accident) and with a set of steam transformers producing the tapping steam on the turbo alternators. The accident happened at the end of a series of boiler start-up tests that were being overseen by 1 technician employed by the product manufacturer assisted by 2 boiler room technicians. At the time of the accident, a firebox tube end broke apart from the tubular plate in creating an opening on the back surface of the boiler. The water contained inside the boiler, exposed to the action of instantaneous vaporisation of the pressurised steam (approx. 13 bar), escaped through this opening. The boiler was projected by the ensuing reaction some ten metres backwards, causing it to become entangled in the scraper of a 250-MW boiler. The steam escaping from the boiler crossed the material handling bay, blasted the mechanical workshop wall and then, by vaporising partially under atmospheric pressure, filled a much larger volume, causing burns to workshop personnel. The human toll of this explosion amounted to 1 death and 17 injured; all victims were working in the same mechanical shop. Even though for some design computation codes the characteristics of this boiler were not acceptable, nonetheless it was still compliant with ISO code rules and French Standard NFE 32.104.



Hydrocarbons heavier than water at the boiler operating temperature were present in the feed water; these hydrocarbons were then deposited onto the firebox tube. This would have caused the transition to vaporisation into film and thus a temperature rise in the metal, which had become hotter than the maximum warranty temperature relative to the type of steel used to build the boiler. The potential for polluting the vapour circuit by fuel oil during its reheating cannot be overlooked: during the recovery of vapour condensates, the fuel oil could have entered into the sumps used to supply the boiler. Since the actual operating conditions at the time of the explosion were not known with certainty, the presence of fuel oil in the feed water combined with extreme design characteristics triggered this accident.

    **ARIA 25923 – 18/11/2003 - 57 - HAUCONCOURT**

46.71 - Wholesale of fuels and ancillary products

   At an LPG filling station, around 2:15 pm, a station employee was drilling in the "automation" utility room located in a zone outside of any risk of gas presence: this room provided access to the administrative building via 3 juxtaposed electrical ducts leading into the building's crawl space. At the time of this drilling task, a flash-arc occurred and burned the employee, who was able to trip the closest emergency shutoff switch. The emergency system secured the site (shutdown of installations and automatic sprinkling of sensitive zones). Site employees quickly controlled this fire breakout. One of them raised a floor board in the room then another board before getting burned by a second flash-arc, which was quickly brought under control using powder extinguishers. Both of the injured employees had to be hospitalised (burns to their faces, hands). The utility room was damaged and the station's activity shut down for a short while. Following verifications, the safety installations were resupplied under normal conditions around 7 pm. The accident would have been caused by a leak on the propane pipeline feeding the administrative building's heating boiler. The copper piping (diameter: 22 mm), laid aboveground from the storage tank (11.6 m³, for heating the administrative building + the filling zone, with direct feeding from the filling zone) and then run underground (diameter: 14 mm) via the crawl space, before reaching the boiler room: a screwed connection in the underground part broke, causing the leak and gas accumulation in the ground along the duct until reaching the crawl space. From this point, the combustible made its way into the electrical ducts, which were not blocked, in the direction of the automation room. The drill provided the flash point for the first flash-arc. The second time around, a hotspot smouldered and raising the floor boards created a draft that reignited the remaining gas. At the suggestion of inspection authorities, a prefectural restraining order requested the periodic verification of all pipelines, along with the monitoring of strength and seal inspections and an update of the internal emergency plan. The operator planned to implement the following measures at this site: placement of a 1.7-m³ tank dedicated to heating the administrative building, and filling of the heating tanks from a lorry. The operator also ordered all sites under his control to reference all underground pipeline

segments and then undertake a program of converting these into aboveground segments, in addition to a campaign of blocking all electrical supply ducts in off-zone locations.

  **ARIA 26252 – 19/01/2004 - ALGERIA - SKIKDA**

19.20 - Oil refining



An explosion occurred around 6:40 pm at a port petrochemical facility, located on the Algerian coast and composed of 6 gas and hydrocarbon treatment units; a total of 12,000 workers were employed on this site at the time, which was in part fuelled by gas and oil from the Sahara region.

The accident occurred inside the natural gas (LNG) treatment facility, subsequent to the explosion of a high-pressure boiler responsible for producing the vapour. Given the violence of the explosion, nearby tanks containing inflammable substances were also damaged: the resulting leaks then caused the fire to spread, with different outbreaks in turn triggering new explosions (the "domino effect"). The blast from the explosion, heard over a 10-km radius, broke building and shop windows in the vicinity. A crisis unit was set up by the operator and the Interior Minister; the prefect ("Wali" in the local administration) activated the equivalent of an external emergency plan. It took local fire-fighters around 8 hours to bring the blaze under control.

The ultimate human toll was very serious: 27 killed among the staff, including 9 security agents manning neighbouring stations, and 74 injured (43 of whom left hospital the next day after undergoing medical exams). The majority of deaths were caused by the effects of a pressure surge or the projections and collapse of structures.

The estimate of property damage rose to 800 million dollars. Three of the six liquefaction units were destroyed. Debris was ejected up to 250 m from the epicentre of the explosion, yet actual damage at the site remained limited.

According to witnesses, strange noises corresponding to vibrations or leaks from valves were heard prior to the powerful explosion. The unit ("Train 40") where the explosion occurred seemed to display frequent operating anomalies. After a major leak notified by a maintenance agent, who would die in this explosion, a mix of air and gaseous hydrocarbons was suctioned by the air inlet of the Train 40 boiler, causing an initial explosion inside this boiler, followed by a second deflagration outside and then a fire destroying adjacent "Trains 20 and 30" separated just 60 m from one another.

  **ARIA 32777 – 05/02/2007 - 45 - SAINT-JEAN-DE-LA-RUELLE**

35.2 - Production and distribution of gaseous fuels

A public works company, assigned to conduct earthworks using a mechanical shovel, accidentally hit the connection to natural gas-powered boilers, causing an explosion followed by fire. The pipeline was torn at the level of the station's input flange. The boiler room, juxtaposed with a building, was half sunken into the ground. The company had filed a works authorisation request with the gas utility and possessed a map of

the utility network lines. A fire-fighter declared having seen flames surge forth from a duct in the boiler room. Gas would have likely spread via the PVC tube surrounding the burst pipe and diffused through a crack in the duct heading towards the boiler room. The heating unit, which relied on atmospheric burners, depended for its air supply on another duct dropping to ground level, while the upper ventilation consisted of a 2 m x 2 m chimney anchored at the level of the flat ceiling. Gas ignited when in contact with an electric motor or the flame from a burner. Six employees, including 4 members of the worksite crew, were slightly injured.

  **ARIA 32817 – 29/11/2006 - 77 - GRANDPUITS-BAILLY-CARROIS**

20.15 - Manufacturing of nitrogenous products and fertilisers

At a chemical plant, an explosion occurred and a leak ignited at the level of a valve flange on the turbo compressor located in the ammonia (NH₃) production facility, which was in the process of being restarted. The hydrogen detectors and fire alarm notified the control room, triggering immediate shutdown of the facility. Rescue crews were quickly able to control the event. The internal emergency plan was not

activated.

The accident caused no casualties, as the technician present in the vicinity was able to escape just before the explosion, after hearing the whistling sound associated with the discharge of synthetic gas, composed of 70% hydrogen (flow rate: 15,000 Nm³/hr). Physical consequences of the turbo compressor's direct environment involved: electrical cabling, melted cladding, heavy damage to heat insulation on the pipeline. Ammonia production was shut down for more than a month.

Five days prior to the accident, a problem related to the of CO₂ absorption defect at the level of the decarbonation column in the NH₃ production facility, which was being restarted, led site technicians to open the vent downstream of the column before activating the high-temperature safety procedure. This excessive venting (due to operating error) caused a sudden drop in suctioning pressure at the NH₃ synthesis turbo compressor while triggering the facility's emergency shutdown. The valve positioned on the line between the turbo compressor and the anaerobic digestion reactor was thus placed into operation under high pressure and opened without any technicians noticing.

During the ensuing days, production resumed, yet an abnormal synthetic gas reading led the operator to conduct further investigations and discover that the previous valve placed under such pressure was no longer sealed: it was allowing gas to escape via a 47-m high chimney. The facility was stopped once again to allow replacing the suspected valve.

The unit was started once again. The anaerobic digestion reaction began at 10 pm; the synthetic gas turbo compressor started up at 1:30 am and the accident happened at 3:14 am on the flange of the newly-installed valve (diameter: 6", approx. 150 mm).

This accident was due to insufficient valve calibration; upon start-up, the valve fluttered, causing vibrations that eventually led to rapid loosening of the flange nuts, which most likely had not been tightened enough at the outset. The lack of traceability during these jointing operations (torque) was also highlighted.

As for feedback, the company assigned the valve calibration task was required to undergo certification by the plant inspection unit, resulting in an improved jointing protocol, more rigorous specifications regarding jointing, upgrades to the revised valves, and implementation of an additional pressure sensor.



Rail accidents in urban areas



©MAUZIO DELI INNOCENTIPAMAXPPP

Derailment and explosion of LPG railcars

ARIA 36464 - 29/06/2009 - Italy - Viareggio

49.20 - Rail freight transport

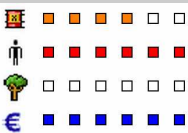

Shortly after crossing a train station at a speed of 90 km/hr around 11:45 pm, the conductor of a convoy of 14 railcars containing 110 m³ (45 tonnes) of liquefied petroleum gas (LPG) felt a jolt and noticed the derailment of 5 tanker cars, which were laying on their side. He activated the emergency brake, stopped the engine, folded the pantograph and ran towards the station 200 m away for protection.

After hitting either an obstacle just beside the track or a rail switch, as evidence has confirmed, the first railcar steel was torn over a 40-cm length and a width extending between 2 and 5 cm, thus causing an LPG leak,

along with the formation of a dense cloud that would subsequently explode (a UVCE type explosion) upon reaching nearby residences. An intense fire engulfed the premises ; two other explosions were heard a bit later, and another violent fire was blazing at the derailment site itself.

A state of emergency was declared for the entire region, triggering the deployment of over 300 fire-fighters, in addition to heavy assets from both the national and regional levels. The fires were extinguished by sunrise the next morning, while tanker cooling and site clearing activities continued throughout the day. Specialised units then relayed one another in order to empty the cars before being turned upright with a crane and fully discharged. This emergency response was completed 48 hours later.

The toll of this disaster came to 32 fatalities, with a few individuals succumbing several days afterwards, plus 50 injured, among whom 30 seriously hurt. Within a radius of 200 to 300 m, a single-family dwelling and 2 residential buildings were destroyed, while 4 others were heavily damaged with the collapse of a section of their living quarters; a total of 100 individuals had to be relocated. Windows were shattered over an even wider zone. Another 1,100 individuals were evacuated for safety reasons. Several vehicles burned and sections of railroad track were totally deformed by the heat. The extent of damage was estimated at €32 million.

The derailment had been caused by a fatigue fracture of the front axle of the convoy's first railcar. In conjunction with the judicial investigation, the railway undertaking ("contract operator") conducted separate investigations to determine the exact causes and circumstances surrounding the accident. The lead car and subsequent vehicles belonged to Polish and German railway undertakings. Placed into service in 2003 and 2006 respectively, these cars had undergone the required regulatory inspections in March 2009 and were scheduled for checking in December 2009. According to sources cited in the press, inadequate maintenance of these cars, whose axles were reported to be rusted, was also identified as a contributing cause.

This disaster was the most serious Italy had experienced in the rail transport industry for dangerous goods and moreover one of the country's most severe accidents ever catalogued involving the production and distribution of LPG. The initial feedback exposed a number of failings relative to :

- identification and evaluation of accidental events, safety analyses and residual risks (see the SEVESO Directive dedicated to fixed installations), along with the planning and updating of techniques and/or management solutions designed to mitigate risks. The high speed of railcars in the vicinity of a station (i.e. very dense rail traffic within an urban setting) would seem to be a major shortcoming regarding safety ;
- recognition of equipment scheduled for regular inspection, and definition of maintenance procedures. Adequate vehicle maintenance efforts, including the regular testing of railcar axles and other rolling stock, no doubt constitute another factor to be listed as one of the principal accident causes (i.e. fatigue failure) ;
- determination of responsibilities, resources and activity scheduling. The responsibilities of each actor involved in railcar management and mandatory inspections had not been clearly defined.

A working group devoted to freight railcar maintenance, assembled by the European Rail Agency (ERA), concluded its sessions by stressing the need to harmonise the various maintenance systems and protocols existing throughout Europe.

Rail accidents in urban areas

In France, three-fourths of the total tonnage of hazardous freight being hauled is shipped by road, 15% by rail and 3% by waterway, while the pipeline only accounts for a very small share of this transport activity. In 2009, 13.8 million tonnes (Mt) of hazardous freight were transported by rail (vs. 79.4 Mt by road), amounting to a 17% share of total rail freight volume. This type of transport is handled 75% of the time by full trains, with 95% of railcars being tanker cars, responsible for conveying: 6 Mt of flammable liquid materials, 5.2 Mt of various chemical products, and 2.6 Mt of compressed gas, whether liquefied or dissolved under pressure.

As regards prevention, the law adopted on 30 July 2003 introduced the requirement for transport infrastructure managers (of marshalling yards, road parking lots, maritime and river ports), whose facilities accommodate a large quantity of hazardous freight, to complete a safety report. A decree dated 3 May, 2007 specified the application conditions effective for this law, in addition to the legally mandated time frame for submitting such reports by May 2010. This decree also defined the thresholds at which point a safety report is to become mandatory.

This legislative framework was completed by Law No. 2010-788 enacted on 12 July 2010 (so-called "*Grenelle 2*", Art. 218), which confers upon the Prefect additional policing powers so as to penalise the failure to submit a safety report and, as needs arise depending on report contents, to impose structural and operating modifications.

All rail transport must also comply with the Regulation relative to international railway transport of hazardous freight (or the "RID" Regulation). Each railcar, dedicated to a given type of freight, must satisfy a set of resistance criteria defined for every category of hazardous freight, including considerations like corrosion resistance and removal of all porosity.

The rail transport of hazardous freight is responsible for 5 times fewer accidents per tonne transported than road transport, yet has always had the potential to cause very serious accidents, especially when track runs through urban areas, i.e. central city train stations, railways alongside residential dwellings.

The composition of materials transported and accident typology (ARIA [349](#) / explosion of pyrotechnical substances, [5382](#), [5895](#), [6919](#), [6938](#), [7436](#) / BLEVE, [26980](#) / collision of 2 trains carrying incompatible substances), as well as residential density and local population distribution, and the unique topography of certain sites (ARIA [4225](#) / sloped, street paralleling the track) provide a large number of factors capable of exacerbating the original accident, in terms of not only the number of victims, but also the subsequent damage and environmental impacts (ARIA [5642](#), [349](#), [5895](#), [26980](#) / number of victims, extent of affected zone).

The extensive and uncontrolled spreading of flammable liquids can also introduce major risks. The near-immediate and systematic ignition of such liquids generates a tremendous heat flow rate locally (ARIA [4225](#) / ignition of a building and meadow 100 m from rail tracks, [5073](#) / 80-m flames at 1,000°C) or is capable of leading to domino effects (ARIA [5382](#) / ammonia tank consumed in the flames). Sewers and other outfalls have in some cases worsened the situation by "streamlining" the flow of materials released over long distances, or by unexpectedly "shifting" the event and its consequences (ARIA [4225](#) / stormwater collector pipes and lift station located in the middle of a residential subdivision, [32592](#) / explosion, pollution of a river), while causing new risks such as ATEX (explosive atmosphere) zones, explosion and the projection of equipment, accessories, splinters, materials, etc. (ARIA [4225](#) sewer plates, [5073](#) / craters).

As regards feedback transposable to classified facilities in particular, this kind of spreading of flammable materials needs to be addressed in the safety reports and emergency plans specific to such installations. When accidents actually take place, a substantial deployment of responders and equipment becomes necessary to rescue individuals as quickly as possible and limit the spread of hazardous material flows through sewer systems and into the natural environment.

Major leaks of toxic liquefied gases, liquid substances or solids can also occur after the rupture or puncture of transport tanks (ARIA [5515](#) / epichlorhydrin, [7436](#) / CO₂, [16232](#) and [21199](#) / NH₃) or be feared to occur due to sensitivity of the given location (ARIA [16924](#) / herbicides); also taken into consideration herein is the emission of heavy toxic fumes (ARIA [5642](#) / leak and hydrolysis of phosphorus trichloride, [33274](#) / ignition of phosphorus carried by railcars).

Beyond the specifics of a given accident, including heat, explosion risk and the eventual presence of toxic gases, rescue teams may have to face a wide range of difficulties during emergency response, namely :

- organisational: roles and responsibilities of the various actors (ARIA [2438](#), [3468](#), [4225](#)), large numbers of local residents to evacuate (ARIA [349](#), [5515](#)), property to protect (ARIA [6938](#) / retail shops), relocation of damaged or deteriorated railcars to a safe depot prior to the eventual transfer of contents (ARIA [3468](#), [19326](#) / large-scale evacuation measures) ;
- technical: high-voltage electrical lines (ARIA [3468](#) / catenary lines), widespread electrical outages necessitating the use of autonomous means (ARIA [2438](#) / motor-driven pumps, [4225](#)), leaks of hazardous materials difficult to clog (ARIA [3468](#) / a leak impossible to clog without custom-built equipment) or to transfer (ARIA [3468](#) / immersion rod, [21199](#) / hose and valve), reliance on special lifting and transport equipment (ARIA [3468](#) / crane and flatbed car, [35530](#) / cranes, [37598](#) / high-capacity flaring device), structural cutting and other hazardous operations (ARIA [39500](#) / risk of iron-chloride reaction) ;
- difficulties leading to pile-ups and domino effects (ARIA [5382](#) / BLEVE-type explosion involving an NH₃ car in a fire, [6919](#) / fire and several BLEVE-type explosions of LPG cars, projectiles reaching a filling station, [6938](#) / BLEVE explosion of LPG cars, fire inside a plant and neighbouring facilities, [26597](#) / explosion subsequent to contact between incompatible materials: sulphur, gasoline, fertiliser and cotton).

Following the initial emergency response, it becomes essential to quickly ensure the safety of all affected sites (ARIA [2438](#) / gas odours, cleaning of shafts and cellars, decontamination and ventilation of sewers, [4225](#), [5515](#)), and then to assemble and implement both human and material resources for assessing and absorbing all eventual pollution (ARIA [2438](#) / choice and efficiency of treatment strategy, [4225](#) / use of a "proven" technique, [5073](#)). Several catalogued accidents demonstrate that though the emergency response might only last a few hours, ensuring the site's safety could take several days, while pollution clean-up of contaminated zones and any eventual restoration work is capable of spanning many months.

A system for reducing risks at the source when dealing with this type of accident relies upon :

- the reliability of rolling stock, whose improvement depends on public authorities, responsible for establishing construction standards, as well as on builders assigned the implementation task, certified maintenance workshops dedicated to the equipment, car holders responsible for railcar condition, and shippers in handling their loading duties ;
- the introduction by some rail operators over the past few years of experts for transporting hazardous materials within each operating region, for the purpose of enhancing risk management on exposed sites. These experts are assigned to identify, notify and manage potentially hazardous situations, in collaboration with loading personnel and emergency response teams. Their mission also entails complementing responder training in the field and verifying procedural efficiency ;
- any train carrying hazardous substances now requires a permit to travel on pre-established routes, with a special transport plan adopted for radioactive materials. Continuous hazardous substance monitoring should, under normal conditions, indicate at any point in time the type and location of risks, as the rail infrastructure manager is required to maintain all corresponding information up to date and available ;
- signalling, by means of orange signs posted on railcars displaying hazard and material identification numbers, serves to identify the product being transported as well as the hazard it presents, while referencing the corresponding safety fact sheets ;
- As a complement to this set of information, police officials can also call upon the technical assistance of the shipper, who remains responsible for merchandise in the shipment, or instead upon the recipient. The TRANSAID protocol (signed in 1987 between the Interior Ministry and the French Union of Chemical Industries) also empowers emergency response teams to request input from competent technicians at chemical installations located closest to the accident scene, in order to obtain qualified assistance for several hundred different chemical products, in the form of information, advice and/or assistance and action at the scene ;
- lastly, the rules specific to the RID Regulation relate to the circulation and parking of tanker cars on rail network lines: railcar parking time limited according to the transport plan defined by the infrastructure manager (Art. 2.3.1.1 of the TMD decree governing the transport of hazardous substances), parking in dedicated zones.

As regards protection at the national level, the infrastructure manager prescribes measures to be adopted in the event of an accident or incident in accordance with rail operating principles. For each marshalling yard, the manager is required to implement a Hazardous Freight Plan. Designed as a decision-making aid for crises related to an accident/incident, this plan must :

- ensure the efficiency of emergency service alerts ;
- organise emergency response conditions ahead of time ;
- depending on the severity of the accidental situation, focus on the safety of individuals present onsite as well as on rail traffic safety (evacuation of all or part of the site) ;
- acknowledgment of information available on individuals present onsite and employees involved in permanent activities, by the dissemination of warning messages, as well as information on site foremen responsible for overseeing facility conditions.

These plans are developed through a coordinated effort with the emergency services. Their efficiency presumes incorporating the site's local specificities : type of hazardous substances, traffic volumes, quantities, site configuration and special vulnerabilities (urbanisation, water table). This requirement leads to differentiating Hazardous Freight Plans across sites, while all still target the same safety objectives. Hazardous freight plans encompass all activities taking place at the given site, whether performed permanently (e.g. workshops, depots) or on a one-time basis (through-trains, temporary building projects).

In all other train stations, the infrastructure manager is able to implement a Local Hazardous Freight Plan, which sets forth the guidelines for assigning each party's missions (employees, public safety services, etc.), in coordination with existing departmental safety plans at the periphery of each included site. These plans serve to assist public safety personnel as a crisis unfolds.





Periodic drills are organised each year in order to test the efficiency of these plans, while offering the opportunity for emergency services to better assess the local context and its evolution over time.

Additional references (detailed accident reports) :





- ARIA 2438: Derailment of a train transporting gasoline to Chavanay (42), on 3 December 1990.
- ARIA 4225: Derailment of a train transporting gasoline to La Voulte-sur-Rhône (07), on 13 January 1993.





Accidents whose ARIA number has not been underlined are reported on the Website :

www.aria.developpement-durable.gouv.fr





     **ARIA 349 – 04/06/1988 - RUSSIA - ARZAMAS**

49.20 - Freight rail transport

    An explosion of 3 railcars loaded with 120 t of explosives caused 93 deaths, 700 injuries treated at emergency centres and 230 hospitalisations. Property damage was extensive: 150 houses destroyed and damaged, 600 families left homeless and 90,000 residents evacuated. Window panes were shattered over a 15-km² area.

     **ARIA 2438 – 03/12/1990 - 42 - CHAVANAY**

49.20 - Freight rail transport

    A 22-railcar convoy derailed at 11:50 pm in a small town of 2,000 residents; 9 tanks carrying 80 m³ of unleaded fuel spilled, ignited and exploded. This burning gasoline consumed dwellings and reached the sewer system. Electricity had to be shut off and vehicle traffic diverted. The fire was brought under control by 6:30 am on the 4th following the intervention of 180 fire-fighters equipped with separate resources (e.g.

motor-driven pumps).

A village resident was injured, 34 others housed elsewhere. The accident zone extended over 1 km strip 400 m wide; 8 dwellings, 2 garages and 30 cars were destroyed, and another 5 houses were damaged. 250 to 300 m³ of gasoline polluted 2 ha of ground. Potable water extraction zones were threatened 100 m away and "gas" smells were reported on several nearby properties. The use of agricultural wells was prohibited, water pumping was restricted, and fruits and vegetables ruled unfit for consumption within a 12.5-ha zone. Administrative decisions were quickly made to demolish the affected dwellings.

The municipality and rail operator contracted a pollution cleanup firm; 10% to 20% of the hydrocarbons (HC) were combusted or had evaporated, while 80% to 90% of gaseous or liquid HC were trapped in the soil layers above the water table (i.e. "unsaturated zone"), both in the rail embankment and at the surface of the water table within a thin clayey formation at the base of a hillside. The shafts and caverns were cleaned. The polluted zones were treated with water table drawdown (16 m³/hr via 3 pumping stations), reduction of the polluted zone by characterising the subsoil and contamination (an expert body, 40 boreholes), then a 3-stage cleanup :

- pumping/skimming of the water table: 40 m³ of HC recovered during a 17-month period, with discharge into the Rhone River of all drawdown water containing less than 20 parts per million (ppm) of HC ;
- bioleaching testing, through probing in vain beyond 2 m of depth, this stage would be abandoned ;
- highly efficient vacuum extraction (venting), giving rise to a call for tender with quantifiable objectives: HC content of soils no greater than 10 ppm, absence of HC supernatant in the water table following 1 year of cleanup.





After 45 weeks of treatment, 210 m³ of HC were extracted from the parcels not returned to their owners, but instead expropriated by the municipality for public facilities, thus simplifying the adoption of soil/subsoil use restrictions included in land use planning documents, in order to guarantee a long-term use allocation compatible with the presence of residual pollution.

The public investigation pointed to excessive train speed (93 km/hr) with respect to the defect ("warping") of rail track, whose foundation was weakened subsequent to heavy rains. For the railway operator, the cost of this accident amounted to 28 MF (1991 currency) in emergency measures, studies/pollution cleanup of the site, plus another 22 MF in compensation (third-party losses / municipality).





After the initial emergency response, the municipality, railway company and administrative authorities had to make quick decisions to assess the actual/potential extension and consequences of the pollution, before implementing suitable measures aimed at preventing propagation, without the time to estimate their duration/costs in the absence of clearly-defined lines of responsibility.

This vacuum extraction, or venting, technique was again used a few months later following another accident on this same section of track 100 km further south (ARIA 4225). The bioleaching tests demonstrated that the pollution cleanup technique depends on both the pollutants and the target media, i.e. type of soils, permeability, water table depth, flow velocity.

As regards feedback applicable to classified facilities, the potential consequences of this kind of accident imply the emergency use of resources in order to contain flow, before implementing other resources to evaluate and absorb the pollution. The massive, uncontrolled spreading of flammable liquids could generate high risks, especially during network flows (e.g. ATEX Directive). Such situations need to be taken into consideration when drafting safety reports and emergency plans.

     **ARIA 3468 – 16/03/1992 - 73 - AIX-LES-BAINS**

49.20 - Freight rail transport

    A 28-railcar convoy, with 3 cars carrying hazardous substances, derailed at 2:25 am right at the train station in the middle of the city, just a few tens of metres from the closest residential buildings. The 11-kV drop in cables on the overturned railcars triggered the ignition of a 20-tonne tank of dimethylamine (DMA). 20-metre high flames were observed; moreover, 2 nearby cars contained 40 tonnes of ammonia (NH₃) and 20 t of methyl ethyl ketone (MEK). Some of the catenaries were ripped out, while others were deformed by the heat.

Notified at 2:30 am, a team of 50 fire-fighters arrived at the scene 7 min later with the appropriate foam. The fire was extinguished at 3:50 am, but a malodorous cloud led authorities to: introduce a 400-m safety perimeter, order the evacuation of buildings in the vicinity, and request all other neighbours to remain indoors. The cloud was diluted with a water curtain. A leak ultimately identified around 5 am on the DMA railcar was only precisely located on a flange of the damaged drain 5 hours later. An Operational Control Station was set up at 10:30 am, at which point the Prefect activated the TRANSAID procedure. As of the beginning of the following afternoon, both the municipality and prefectural departments regularly informed the population either directly or through distributing flyers.

Emergency services were unable to install a new flange without the assistance of specialists, who were being actively sought. By 5:30 pm, the leak was 95% plugged. A customised "bell" was installed on 17 March at 6 pm for the purpose of better controlling the residual emissions. Sprinkling of the tank was halted, and the DMA caught by the bell was neutralised by dissolution in water.

After a full day of assessing the situation, all onsite transfers were stopped; the DMA car from then on was to be raised and moved to a safer place within the special convoy. These operations were prepared down to the finest detail, then the DMA car was raised on 18 March at 6:10 pm and removed at 8:24 pm onto a lower-level platform 20 km from the accident site; since the convoy was unstable, the journey lasted nearly 3 hours at 8 km/h. The car was then placed upright on 19 March and cooled with carbon dioxide (CO₂) in order to balance the pressure and void using an immersion rod. The slightly-damaged car carrying NH₃ would be towed to its final destination.





Thanks to an overall favourable context, as well as the tank design and quick response time by the emergency services, the accident exerted no major impact on the environment, although the municipal treatment plant was minimally polluted by runoff water through the stormwater drainage network. Trains were allowed to resume circulation on 20 March around 6:30 pm. Six cars left the track (nos. 3 through 8). The 3rd of these, a two-axle grain carrier, empty and intended for the scrap yard, derailed 1 or 2 km from the station. Arriving out of alignment, this car slammed into containers and docks, causing derailment of subsequent cars.





This accident highlighted, at the very least, the need to draft as quickly as possible Specialised Emergency Plans for the Transport of Hazardous Substances, as indicated in the pertinent regulations (Circular 88/404, issued 22 November, 1988).





The Transport Ministry assembled a special public investigation commission in order to determine/analyse the causes of this accident and draw lessons in the area of prevention and organisation of rail transport system for hazardous substances. Some 30 recommendations were relayed to the rail operator in order to:

- define preventive measures on the equipment and track to avoid derailment risks and ensure their rapid detection;
- improve the safety of hazardous substance transport;
- build an assessment of the factors leading to derailments (through both a theoretical approach and feedback);
- help clarify responsibilities of the various actors in the handling of serious accidents;
- participate actively in the development of emergency plans, within the scope of the action plan initiated by the Interior Ministry.

     **ARIA 4225 – 13/01/1993 - 07 - LA VOULTE-SUR-RHONE**

     *49.20 - Freight rail transport*

     A 20-car convoy left a tunnel around 11:30 pm in order to cross a train station when 7 tanks carrying 80 m³ of gasoline derailed. An axle with an overheated bearing housing broke on one of the railcars. Traces on the rail ties and ballast attest to the fact that this car followed the convoy for a distance of 300 m and left the track in the direction of a rail switch 100 m or 150 m ahead of the derailment.

     With a shell torn over 1/3 its length and a bottom check valve torn off, 4 of the tanks emptied their contents, a violent fire broke out, and the rail conductor moved the remaining cars out of danger. 15 to 20 minutes later, one of the cars overturned and opened, leading to an explosion and fireball; the heat flux alone burned a dwelling and field located 100 m from the tracks. Streams of burning hydrocarbons (HC) spilled 20 m below onto a street lined with buildings, which served to channel the ignited gasoline; a total of 15 houses and 15 vehicles were destroyed. Cast iron sewer plates were projected some 15 to 20 m high, then a fire and series of explosions destroyed the stormwater pumping station 250 m downstream, preventing pollution from flowing into the Rhone River.

The fire was extinguished during the morning by a crew of 250 fire-fighters. Within a 600 m perimeter, 1,000 individuals were evacuated at night; 6 injuries were reported. The conductor and 2 residents sustained skin burns, 3 others suffered fractures and contusions while escaping the flames.

Commissioned by the municipality and rail operating company, a consultant assessed the consequences of this accident and monitored the introduction of site safety features: cleaning/inerting of sewers by pumping and ventilation (3,000 m³/h), inventory of access points, inspection of gas contents and collector pipes to eliminate eventual pockets of HC. Then came the pollution cleanup effort: 20 m³ of the remaining HC inside the railcars; 300 m³ lost; 200 m³ burned/evaporated during explosions (either in sewers or after ventilation); and 100 m³ in the soil and water table (from 1 to 4 m deep). Yet municipal water collection further upstream was not compromised.





Within a few hours, 16 piezometers were drilled into place. In 4 days' time, 110 water samples and 250 "gas" measurements were performed in the soils, on a daily basis for a week, allowed evaluating the pollution. Heat from the fire facilitated degassing of the soil, yet the measurements still indicated a 1-m deep pollution in the embankment underneath the tracks (covering 1.1 ha), as well as subsoil in the urbanised part of the embankment reaching 80 m (1.5 ha). HC contents exceeding a max of 2,500 ppm were recorded in the instruments. A CNR drain along the embankment drained the floating HC, with a portion being recovered prior to the station. To draw down the water table, 5 wells (1.2 m in diameter) were dug beginning on 18 January, 1993.

The zones with persistently abnormal values were to be ventilated and cleaned. Used previously after an accident on this same track in December 1990 (ARIA 2438), the selected "venting" technique limits treatment time and costs. To both the north and south of the polluted parcels, 2 networks placed the soils in depression (differential pressure = 250 mbar) and a hydraulic dam completed the set-up on the eastern side. All drained HC were incinerated in 2 mobile furnaces. 98% of the HC was recovered within 4 months, during which time 100 people had to be housed in new accommodations.

According to the rail company, the rehabilitation and compensation costs (for third parties and the municipality) amounted to 70 MF (1993 currency), including 15 MF to rebuild the station and another 5 MF on treatment. Shortly thereafter, the company created an entity for the purpose of monitoring the isolated railcars (diffused traffic) and convoys in real time, in addition to providing advice and information in the event of a transport accident in order to make prudent use of public sector emergency response services.





Whether in transporting hazardous substances or at classified facilities, the potential consequences of a massive uncontrolled spreading of flammable liquids implies an emergency intervention to limit propagation and quickly implement the resources that allow evaluating and treating the pollution. Substantial risks, especially in the case of network spills (covered by the ATEX Directive), need to be incorporated into safety reports and emergency plans.

Beyond the initial response, attention quickly turned to the issue of limiting the scope of subsoil and sewer network pollution by hydrocarbons. The entities present (municipality, rail transport company and administrative authorities) had to cope, under emergency conditions, with the need to make decisions to evaluate, without delay, extension of the pollution and the seriousness of actual and potential consequences. They were also faced with implementing measures to prevent the spreading of hydrocarbons, even though responsibilities had not been clearly defined and no estimation of either the duration or costs of these measures was available.

     **ARIA 5073 – 08/03/1994 - SWITZERLAND - ZURICH**





49.20 - Freight rail transport

Following an axle break, one of a train's 20 railcars, each of which contained 75 m³ of gasoline, derailed, caught fire and exploded at the station. The fire reached 4 other railcars, destroyed 3 buildings alongside the tracks and damaged a 4th building set back slightly (80-m high flames, 1,000°C). The gasoline flowed into the sewers and caused explosions (10-m diameter crater); a stormwater collector pipe was also damaged (total damage in excess of 30 MF). The district was evacuated for a day (200-m radius, 120 individuals); 1 serious injury and 2 slight injuries were reported, including one responder (projections sewer plates). Local river fauna was impacted. Two explosions occurred subsequently, one the very next day (caused by a spark from a crosscut saw). Total damages were estimated at 200 MF.

     **ARIA 5382 – 08/04/1979 - UNITED STATES - CRESTVIEW**

49.20 - Freight rail transport

Following a derailment, a fire and series of explosions (of the BLEVE vapour explosion type) occurred on railcars transporting flammable products. A railcar carrying ammonia, caught in the fire consuming cars carrying acetone, methane and chlorine, exploded 20 minutes after the fire broke out. A total of fourteen injuries or intoxications were reported, along with 4,500 evacuations within a 2,500-m radius. Fragments of railcar shells were projected up to 200 m from the site of the accident. The investigation outcome pointed to a criminal attack.

     **ARIA 5515 – 29/06/1994 - SWITZERLAND - LAUSANNE**

49.20 - Freight rail transport





A train derailed at 2:56 am at the Lausanne rail station; 7 of the 50 cars on this 690-m (1,753-tonne) convoy were on their side on the track. Two cars transporting a total of 80,000 litres of epichlorohydrin leaked, allowing 400 litres of a toxic, volatile and flammable chemical product to escape. The alarm was sounded at 3:14 am, with over 500 fire-fighters arriving at the scene to: plug the car openings, recover the product that had spread, and ventilate the sewers. The entire district, accounting for 1,500 residents, was evacuated as a safety measure during the emergency response. No injuries were reported. Over the ensuing 4 days, the tanks of both epichlorohydrin and thionyl chloride were emptied, the overturned cars were placed upright, discharged or returned to their recipients. The local population would have to be evacuated a second time when performing hazardous operations (e.g. standing the cars upright).

The accident was caused by a switching error. The train entered the station on track no. 3. When it crossed onto switch 76a, on the eastern side of the station, the 25th railcar (which was rolling empty on its 2 axles rose, then fell adjacent to the tracks and stayed on its path by rolling along the railroad ties, while being supported by the platform edge. The train was making a service stop at the station in order to rotate conductors; however, upon restarting the convoy, the wheels on the derailed car remained trapped between the rail and the platform edge. At the end of the platform, in the track switching zone, the 2 cars preceding the empty car, along with the 11 subsequent cars, derailed. Of these 14 cars that left the rails either totally or partially, 5 of them, including 3 tanker cars containing hazardous freight, were lying sideways on the track. The one was transporting thionyl chloride and the other 2 epichlorohydrin. The first epichlorohydrin tank was slightly punctured, which caused the contents to flow out. The cars containing hazardous substances damaged in the accident carried respective capacities of 47,000 litres of epichlorohydrin and 24,000 litres of thionyl chloride.

     **ARIA 5895 – 19/07/1974 - UNITED STATES - DECATUR**

49.20 - Freight rail transport

In a marshalling yard, operator error caused a perforation in back of a tanker car. A 63-ton cloud of isobutane dispersed over a zone spanning 800 m by 1,200 m. The ignition occurred between 8 and 10 min after the rupture of the car. The explosion killed 7 employees, and 349 injuries were reported, including 33 among the personnel. Windows were shattered up to 4.8 km away; a total of 700 dwellings were damaged within a 5-km radius, in addition to 11 public buildings. Major structural damage was recorded out to a distance of 1.6 km. Another 283 other tanker cars were totally destroyed and 312 damaged. The TNT equivalent of the blast was evaluated at between 20 and 40 tonnes.

     **ARIA 6919 – 21/06/1970 - UNITED STATES - CRESCENT CITY**









49.20 - Freight rail transport

In a rail convoy, a sand hopper derailed, causing the subsequent derailment of 9 propane cars. After being perforated, one of the propane cars ignited spontaneously. The heat released then triggered the safety valve on a second car, creating a torch flame that in turn exploded a third car (BLEVE, vapour explosion). A fragment of car was blasted 180 m, and another piece slammed against the roof of a filling station, causing its collapse. The second car exploded 2 hours later. One of its fragments was projected 500 m. A fourth car exploded, destroying 3 buildings located along its trajectory. 35 minutes after that, another tank broke, followed a short time later by 2 new cars. The fragments of one of these last two wound up causing explosion of the last 2 tankers. In all, 66 people were hurt.



     **ARIA 6938 - 5 July, 1973 - UNITED STATES - KINGMAN**









52.21 - Auxiliary land transport services

A small leak was noticed during transfer operations on a railcar containing 75 m³ of LPG. 1 of the 2 technicians on duty attempted to close the valves using a tool made of aluminium, which may have been the cause of the ensuing gas ignition. He was burned alive, while the other, who sustained serious burns, sounded the alarm. Fire-fighters did not arrive until 25 min later. Tremendous flames emanated from the railcar. Fire-fighters tried to cool the car, but their efforts proved insufficient, resulting in a BLEVE-type vapour explosion. Half the car was projected 365 m. A fireball 45 m to 60 m in diameter could be seen. 5 buildings caught on fire. 12 fire-fighters were burned to death, and 95 injuries were reported. Burning debris ignited a plant, restaurant and store (domino effect). The fires were brought under control after an 8-hour fight.



         **ARIA 7436 – 02/09/1976 - GERMANY - HALTERN AM SEE**









49.20 - Freight rail transport

   Rolling at approx. 16 km/hr in a marshalling yard, a tanker car (90% full) carrying 231 t of liquid CO₂ (-15°C, 7 bar) exploded, though its safety valve remained open. According to various witness accounts, the BLEVE-type explosion had occurred slightly beforehand, i.e. just after this car had made contact with another group of railcars. One person was killed. The tanker chassis was folded into a "V" shape; 22 fragments, accounting for approx. 80% of the tank were projected over a wide range of directions, with angle ranges of 5°-20° and 65°-95° relative to the railcar direction. Some of the projectiles would be found over 360 m away; 3 empty cars positioned on 3 different tracks further down the line were overturned. An analysis of the fragments pointed to a brittle fracture as the cause of the tank's failure.



         **ARIA 16232 – 24/07/1999 - UNITED STATES - IDAHO**









49.20 - Freight rail transport

   During derailment of a 69-car convoy, 135 m³ of ammonia (NH₃) from one of the cars were released into the atmosphere. 6 ammonia cars plus another 6 cars (transporting wood, stones, etc.) fell into the adjacent riverbed. More than 200 local residents had to be evacuated, 2 highways were closed. Several cars were damaged, and a few people were intoxicated by the release. The rails punctured one of the cars, whose entire contents evaporated. A state of emergency was declared during the night and evacuations proceeded over 32 km². A few hospitalisations were recorded. Highway traffic was reopened around 9 am the next morning. A car carrying stones had missed a switch, deteriorating 60 m of track and causing the derailment. The alarm was sounded by an eyewitness who heard the accident and smelled the NH₃.



         **ARIA 16924 – 21/10/1999 - AUSTRALIA - SYDNEY**





49.20 - Freight rail transport

   Six railcars on a freight train carrying herbicides, fertiliser, sodium cyanide and various chemical products derailed. Out of precaution, response teams set up a 250-m radius safety perimeter and evacuated population near the derailment site (5 houses) for 2 hours. Motorists were detoured during the cleanup phase. Similar precautions for air traffic, which was suspended at a radius of 3.2 km and height of 600 m. Formation of a highly toxic cloud was feared in the event of a sodium cyanide leak. Yet none of the product barrels leaked. Over 40 chemical products were present in the train, and the leak volume was estimated at 40 t of herbicides. The situation was brought under control within 36 hours.



         **ARIA 19326 – 28/11/2000 - 26 - PORTES-LES-VALENCE**

49.20 - Freight rail transport









   A tanker car on a 21-car rail convoy transporting 49 t of liquefied propane derailed, for an undetermined reason, as the train was entering into a marshalling yard to change locomotives. Fire-fighters immediately set up a safety perimeter and evacuated 2 neighbouring homes. At the same time, analyses of the explosibility measures yielded a negative outcome. Rail traffic was considerably slowed for 90 minutes. That night, the railcars left on the track continued to be moved. The next day, 500 neighbouring residents were evacuated within a radius of 230 m prior to proceeding with transfer operations on the propane railcar (lasting from 6 am until 9:15 pm), despite the fact that the car showed no signs of leaking. A specialised subcontractor transferred gas from the car into a tank for subsequent lifting. At the conclusion of this operation, the residents were allowed back home. A major logistical effort was deployed in order to manage the evacuation.

         **ARIA 21199 – 03/10/2001 - 13 - MIRAMAS**



49.20 - Freight rail transport





   During manoeuvres that took place around 3:40 am at a marshalling yard, the buffer on a flatbed car standing just after a track switch hit, at the level of its side recovery valve, a railcar transporting 48 t of liquefied ammonia (NH₃) stored at 7 bar. The associated pipeline was twisted due to the shock, forming a crack at the pipeline/tank junction and an ensuing NH₃ leak. The local prefecture activated the external emergency plan and a crisis unit was assembled around 8 am. A 1,500-m safety perimeter was set up and 400 neighbouring residents were ordered to remain indoors.

Special resources for dealing with toxic risks were requisitioned from a nearby firm while awaiting for the product owners to arrive at the scene. Train traffic was halted. The toxic cloud spread with the wind (at 8-10 m/s) to a distance 700 m from the car in a relatively isolated plain. The attempt to transfer the liquefied gas into another car (which arrived 8 hours after) failed due to deterioration of the side recovery valve fixture, which prevented connecting the hose. The leak eventually stopped on its own the next morning. The 48 t of product were dispersed into the atmosphere, as well as into local water sources (streams, and the water table): a portion of this water was actually diluted in the water curtain deployed as a protective measure. Fire-fighters, backed up by specialised units, degassed the entire railcar. The external emergency plan was lifted around 8 am. No injuries were reported.

         **ARIA 26597 – 18/02/2004 - IRAN - NEISHABOUR**





49.2 - Freight rail transport

   A 48-car train stopped in a station broke free of its locomotive around 4 am (local time). The convoy contained: 17 railcars carrying sulphur, 6 with gasoline, 7 with fertiliser, and 10 with cotton. The train overturned a bit further down the track and caught fire. At 9:37 am, as emergency responders considered the blaze to be under control, an explosion evaluated at 180 t of TNT equivalent and heard 75 km away formed a crater 20-25 m deep and 150 m in diameter. At the same time, the Teheran Geophysical Institute recorded an earthquake measuring 3.6 on the Richter scale, yet the two events would not have been directly related. The toll was tremendous: 289 deaths, including 150 civil servants, fire-fighters, rail workers and police officers, with the other 139 fatalities being village residents and bystanders, plus another 460 injured. The 2 villages of Hachémabad and Dehno were totally destroyed and 4 neighbouring municipalities sustained considerable damage. According to the Transport Ministry, this accident would have been caused by human error committed in the station and, perhaps, an act of sabotage (with disastrous consequences) perpetrated by a disgruntled employee.

     **ARIA 26980 – 22/04/2004 - NORTH KOREA - RYONGCHON**

49.20 - Freight rail transport

According to a provisional report, the explosion of two trains in a station led to more than 161 fatalities, including 76 children, and at least 1,300 injured. The explosion was due to a collision, during a station manoeuvre between railcars transporting oil and other trains filled with ammonium nitrate, that would have caused a transmission tower to fall, followed by a short circuit. All buildings within a 500-m radius, including a school, were razed. Some 2,000 apartments were destroyed, along with 129 public buildings. According to initial estimates, total damage amounted to €300 M.





     **ARIA 32592 – 27/11/2006 - ALGERIA - AZZABA**

49.20 - Freight rail transport

A freight train, travelling between Skikda and Annaba, derailed at 1:02 pm in the eastern suburb of Azzaba, where the track had been raised. The locomotive, pulling 16 cars (11 of which containing fuel), suddenly tipped over causing 8 tankers to overturn (7 diesel and 1 gasoline), and a spill of 420 m³ of hydrocarbons (HC).

Major soil vibrations were felt, leading to widespread panic among local residents. The civil protection services evacuated residents from the adjacent zone and established a safety perimeter. A large proportion of the HC released wound up entering sewer pipe inlets, only to exit 800 m further downstream into a river through an outlet near a densely-populated district. Around 2 pm, a fire broke out at the boundary of the main canal, triggering an explosion that spread to the sewers (domino effect). Given the strong pressure created, manholes were unearthed and sent flying, at times more than 15 m into the air, killing a child and heavily damaging the pavement and all cars on it.



Given the extent of this accident, emergency responders were required to protect individuals and property close to the derailment site while at the same time containing the fire and pumping the fuel spread into the sewer system as fast as possible. At 4:30 pm, a petrochemical platform sent a backup contingent from among its reserve forces. Civil and military authorities from the local Wilaya administration as well as the CEO of the rail transport company arrived on the scene. Track was mangled over nearly a 400-m stretch and had to be cut away. Due to the risk of igniting the HC saturating the soils, the rail link, critical to the transport of fuels between Annaba and Souk Ahras, could only be restored around 4 pm the next day following issuance of a permit to use a blowtorch within a given perimeter. The contaminated surface area, covered by sand to absorb the HC, was stripped down to a certain depth. The fuel had also partially polluted the Fergoug Dam water, imposing as a precautionary measure the interruption in drinking water supply to residents of both Mohammadia and Sig. An analysis of raw water samples nonetheless yielded negative results, which were subsequently confirmed by analyses of treated water samples. One death and 4 injuries, one of which serious, were reported. The national gendarmerie investigation assigned responsibility of the accident on a number of executives working for the rail operator, citing them for negligence in maintaining the railway, given its age, and for failure to respect safety criteria, such as tank filling. For its part, the transport company accused the Ramdane-Djamel station's Head of Operations, as well as the train conductor and ticket agent, who would be brought before a disciplinary panel.

     **ARIA 33274 – 16/07/2007 - UKRAINE**

49.20 - Freight rail transport

A freight train travelling between Kazakhstan and Poland transporting 700 t of yellow phosphorus, which is a highly toxic product and extremely flammable when in contact with oxygen, derailed in Western Ukraine: 15 tanks were overturned and 6 of them ignited, creating a white toxic cloud that covered an 86-km² land area. Emergency responders controlled the blaze in 5 hours, then cooled the phosphorus and used a combination of foam and sand to prevent any new fire outbreaks. This information was broadcast to the 11,000 residents of the zone, creating some commotion and panic; in all, 900 were evacuated. Wearing gas masks and staying indoors were initially advised by the authorities. On 18 July, the government began reassuring the local population with announcements indicating that the zone was no longer polluted. The railway was repaired, tank leaks plugged, railcars placed upright, and the convoy sent back on 26 July towards Kazakhstan at low speed, without stopping, in bypassing big cities and accompanied by 2 fire-protection trains. The polluted parcels were cleaned and a dike built adjacent to the site in order to protect a village and collect the polluted water. Some 900 kg of crystallised phosphorus were recovered at the accident site. On 3 August, phosphorus residue left onsite spontaneously ignited.

174 people, including 46 children and 14 responders, were intoxicated and had to be hospitalised. According to the regional branch of the Ministry of Emergency Situations, analyses of the air, soil and water both at the accident site and in the vicinity revealed a rise in the phosphorus rate "two to three times higher than the standard", but just at the epicentre, i.e. covering an area "roughly 1 km²". For its part, the Environment Ministry confirmed that the rate of phosphorus in air was tens of times above standards (3.5 mg/m³ vs. 0.15 mg/m³) in 2 villages, Angelivka and Lisne, but no water or soil pollution was detected. The losses incurred by farming activities were estimated at 109,000 dollars, and the Ukrainian government freed up 2.8 million dollars to eliminate all after effects of the disaster; of this sum, 2.4 million were allocated for social services to protect the children and single mothers. The cause of this accident is still not known, but an investigation was undertaken based on the charge of "railway operating rule violations".

     **ARIA 35530 – 12/11/2008 - 64 - ARTIX**

49.20 - Freight rail transport







Around 9 am, after unloading a convoy of 26 railcars (5 of which were carrying monomer vinyl acetate, 11 had acetic acid and the other 10 were rolling empty but not yet degassed of methanol) inside a chemical plant in the direction of the marshalling yard, 5 of the cars derailed. Two of these cars were transporting 80,000 litres each of monomer vinyl acetate (MVA, a non-toxic yet highly flammable product) overturned below the 5-m high embankment, causing two manholes to open and their contents to spill into the soil.







The gendarmerie set up a 500-m safety perimeter and evacuated 16 local residents; rail traffic and road traffic on the D817 highway were halted; the passenger rail station was also evacuated. Over 70 fire-fighters were called to the scene and laid a 1,000-m² foam blanket under the cars; they were only able to close one of the two manholes, then installed both a buffer storage to recover the MVA still flowing and a dam to prevent pollution from reaching the AULOUE River. At 4:45 pm, the safety perimeter was scaled back to 100 m and rail traffic resumed; train speed however was reduced until the intervention was over. Up to the morning of 15 November, the derailed cars were emptied, inerted and placed upright using two 200 t and 90 t cranes. During these operations, the emergency response team set up powder nozzles around the tanks receiving these transferred products and regularly replaced the foam blanket. The chemical site which sent the convoy emptied the cars on 15 November and the polluted soil on 17 November. The responders patrolled the zone and measured the explosibility potential







until the morning of 16 November: the 16 evacuated residents were allowed to return home. The classified facilities inspectorate and an elected official made a site visit.







A fire-fighter who sustained an injury to his right thumb and received foam projections in the eye, was transported to the hospital. Since MVA is 90% biodegradable within 14 days, aquatic pollution could be avoided and soil pollution limited. Rail traffic was stopped for 7 hrs, 45 min and the highway was closed for 5 hrs, 10 min.

The accident occurred on a turn known to be dangerous, hence the train's reduced speed. According to the rail network operator, this derailment was caused by a technical flaw of the system; embankment sliding due to heavy rains over the previous 2 weeks was cited.







      **ARIA 37598 – 24/11/2009 - 64 - ORTHEZ**







      *49.20 - Freight rail transport*







      The last 2 tanker cars, nos. 26 and 27, of a freight train transporting hazardous substances derailed around 7 pm in the vicinity of the ORTHEZ rail station; car no. 26 carrying 45 t of propane was on flipped its side below the track, while a liquid-phase leak was spilling onto the pipe, which subsequently ruptured.

      A 100-m safety perimeter was set up and the personnel and patients at both a hospital 50 m away and a clinic 200 m away were kept indoors (233 individuals, 190 of whom were patients). Rail traffic was halted in both directions, and electrical supply of the catenaries was cut. Two trains transporting 65 passengers were also blocked; travellers were placed under the authority of emergency services, and some of them were transported to their destination by coach. Fire-fighters installed a 50-cm foam blanket underneath the overturned railcar and plugged the LPG leak by 8 pm; no presence of gas was detected thereafter. The authorities requisitioned a large-capacity flare device and broadcast information messages to local residents; a 120-t rail crane was shipped from DIJON. Passenger traffic between TARBES and DAX was transferred onto coaches. On 25 November, car no. 27 was placed back on the track and evacuated by 10:30 pm. Using the flare to burn gas from the overturned car began on 26 November at 12:30 pm under the protection of fire hoses, including nozzle guns, and ended on 28 November at 8:15 am. The car tanker was then inerted with nitrogen before being placed upright with the help of the 120 t crane after disassembling the catenaries. Rail traffic was reopened on 30 November once the track had been repaired over a roughly 50-m stretch and the catenaries restored to good working order.

      **ARIA 39500 – 22/12/2010 - 57 - WOIPPY**

      *49.20 - Freight rail transport*

      At around 2:10 pm in a marshalling yard, a 4-railcar convoy carrying coal collided with and damaged a group of 4 railcars carrying chlorine (Cl₂), which were nearly empty, not yet degassed and at a full stop.

      Under this shock, 2 tanker cars overlapped one another. A bogie from the first was torn off while the second derailed.

The station's internal emergency plan was activated. A safety perimeter encompassing the split siding was cordoned off. Notified at 2:15 pm, the first responders arrived at the scene at 2:35 pm. After visual confirmation that no leak was present, the car lifting operation was authorised. The station operator informed the prefecture at 8:45 pm upon the advice of an expert with the freight shipping company, who considered that the risk may have been underestimated by the fire-fighters. Called back to the site, the fire-fighting team confirmed their initial conclusions. The safety perimeter was reduced to 4 tracks.

On the morning of 23 December, the quantity of Cl₂ contained in each railcar was evaluated at 1.6 t (1.5 t liquid and 53 m³ of gas). Since the safety report of the yard had not accounted for the dispersion of several tonnes of Cl₂, a modelling request was submitted to the emergency situation support unit of a public agency. The distances of both irreversible effects and lethal effects were estimated at either 1,000 m and 350 m under normal situations (neutral weather conditions and a 5 m/s wind speed) or 3,000 m and 500 m under unfavourable conditions (very stable and a 3 m/s wind speed). A shopping centre was located just 1.2 km from the overlapping cars.

On 23 December at 3 pm, the prefecture assembled the fire-fighters, rail operator, shipping company and classified facilities inspectorate in order to specify the intervention conditions. With the option of onsite drainage rejected, it was decided to secure the overlapping tanker car with a crane at the time of evacuating the undamaged cars via the track. The overlapping tanker car could then be placed on the ground prior to cutting out the bogies with a blowtorch and removing the tank via a flatbed car to a degassing facility. Thermocouples used during the cutting operation would serve to monitor the temperature, given that the steel was capable of combusting when placed in contact with the Cl₂ in the neighbourhood of 120°C. These sensitive operations were held at night.

The accident was caused by the mistaken order to send the 4 coal cars; the automatic braking system failed. Regulations regarding the rail transport of hazardous substances had been modified shortly beforehand in the aim of preventing this very type of accident. The damaged cars had still not been fitted with anti-overlapping devices to protect the back of the cars (temporary period).

The safety report produced for this yard in 2009 had been followed in April 2010 by a compliance request pursuant to the Ministerial decree issued on 18 February, 2010 that had yet to be implemented. The following month, 2 other accidents occurred at this same vital station (ARIA 39508 and 39703) due to the volume of rail traffic into and out of Germany.



Inadequate use of available feedback



ARIA 36628

Explosion of a sulphuric acid tank during hot work

ARIA 36628 – 04/08/2009 - 76 - Gonfreville-l'Orcher

20.16 - Manufacturing of basic plastics



An empty 100-m³ sulphuric acid (H₂SO₄) tank exploded at 9:15 am at a chemical facility. Installed overlooking its retention basin at a height of several metres, this "F2"-type tank was blasted and fell to the ground nearby. The incident caused the scaffolding, set up to provide maintenance, to collapse, bringing down 3 plant employees and 2 subcontractor personnel. Two members of this crew suffered serious injuries : one of the plant employees sustained cranial trauma after falling around 10 metres, while a subcontractor got pinned between the tank and the scaffolding with severe injuries to the face due to discharges from the grinder he had been using.

The plant's internal emergency plan was activated, both in-house and external emergency responders arrived on the scene. The injured were evacuated to hospital ; the site operator informed the local prefecture, town halls and the general public. The classified facilities inspection authorities proceeded with an investigation.

The tank had been temporarily sealed on July 18th, using an impermeable box, following the discovery of a leak on July 16th. Scheduled for repairs at the beginning of August once it had been completely drained, the tank was rinsed with water over the weekend of August 2nd, subsequent to which a subcontractor installed the scaffolding required to perform repairs, allowing for access to the tank and a platinum insulation coating of the process. A plant employee was climbing into the tank to open the cover when the explosion occurred.

The accident appears to have ensued from the accumulation of hydrogen (H₂) at the top of the container and then caused by ignition of the combustible mix formed with air when the grinder cut its way through corroded bolts in the tank cover manhole. The tank was torn apart over half the circumference of the shell / bottom seam, while its anchorages were pulled out. Also, the tank had only been rinsed once; this fact supports the hypothesis of insufficient tank rinsing, which in turn led to acid attack of the metal with a release of H₂.

Available feedback had indicated several explosions of H₂ following the attack of steel tanks by diluted acid (ARIA 23705 on this very same F2 tank in 1989, but also at other sites - ARIA 169, 2278, 31082).

Given the succession of accidents arising over the months leading up to the accident in the petrochemical industry as well as in the transport of hazardous materials by pipeline, a special meeting devoted to industrial safety and environmental protection issues was organised in September 2009 between the Secretary of State for Ecology and key industry leaders. These industry representatives forwarded a series of proposals intended to improve the safety of their installations, by means of tightening controls over facility ageing and maintenance, while agreeing to pay greater attention to ecologically sensitive zones as a step towards enhancing species protection and preserving protected zones.

Inadequate use of available feedback

The feedback from previous accidents constitutes one of the foundations of technological risk management approaches. Such experience-based information must be of assistance in significantly reducing both accident frequency and the seriousness of consequences. Accident analyses offer a source of progress to the extent that lessons drawn are systematically transmitted to potential users and operators [1].

As revealed by the repetition of similar accidents in the ARIA database, these feedback processes, which are quite demanding, remain inadequately organised and applied. They are however intended to be a permanent part of the heritage from industrial sites and from industry in general, in the same way as corporate culture or technological breakthroughs.

The feedback process may be approached using several dimensions [2] :

- The vertical dimension, which encompasses the communication of information within a given entity ; this dimension implies a series of balanced and sustained exchanges between the actors at a site or within an industrial group : senior management, HSE (Health, Safety and the Environment), site foremen, technicians and subcontractors ;
- The horizontal or cross-sectional dimension, which encompasses exchanges external to the given entity ; this dimension requires broadening the dialogue engaged with the industrial sector to sectors involved in comparable issues, both in France and abroad, so as to expand and share knowledge and lessons, with the aim of achieving progress at lower cost ;
- Lastly, the temporal or historical dimension, which constitutes the very essence of feedback since lessons cannot be interpreted and applied without a record in one form or another : incident data sheets, summaries, best practices, professional standards. Repeated reminders regarding this historical record are needed to jog the memory when one of these hazardous processes is being considered for implementation.

At the beginning of the 20th century, Europe's chemical industry was heavily hit by several major accidents tied to the widespread manufacturing of nitrogenous fertilisers. On July 26, 1921 in Kriewald (formerly German Silesia), the "dislodging" of wagons filled with ammonium nitrate using explosives caused a detonation killing 19 (ARIA [17974](#)). Less than 2 months later, on September 21st, in Germany's Oppau plant, blasting work on a pile of aggregated fertiliser mix containing ammonium nitrate and ammonium sulphate produced a detonation responsible for 561 deaths, 1,952 injured and the near total destruction of the town (ARIA [14373](#)). Twenty years after that, in Belgium, explosives were still being used to disaggregate a pile of ammonium nitrate, resulting in another several hundred deaths at Tessenderlo (ARIA [17972](#)). These three explosions highlight the inadequacies of circulating feedback among similar sites over a narrow time frame. Despite the production of asphalt mixes to subsequently avoid nitrate aggregation, several detonations of ammonium nitrate still occurred in succession, causing many victims and significant property damage, both in France (ARIA [5009](#) and [14732](#)) and abroad (ARIA [535](#), [6268](#), [12271](#) and [11145](#)). This background confirms the complex characteristics (e.g. chemical composition, particle distribution, density, humidity) associated with these categories of products and their detonation potential under certain conditions (notably type of mix, hazardous outcome when reacting with other materials or pollutants, temperature, confinement) that some had considered definitively removed from industrial sites, up until the Toulouse disaster in 2001 (ARIA [21329](#)).

The accident at Gonfreville-l'Orcher (ARIA [36628](#)) provides an illustration of how processes have failed in both their historical and cross-sectional dimensions. The same type of accident had already occurred 20 years prior on the same site and even on the same tank (ARIA [23705](#)), but since at the time of the first incident no consequences other than property damage had been observed, the occurrence was noted in the facility tracking file, yet without drawing enough of a lesson to caution workers 20 years hence about the risk of forming a hydrogen cloud when the tank has not been sufficiently rinsed. The steel attack by acid, though diluted within a confined space, still led to the classical accumulation of hydrogen and formation of a highly-explosive atmosphere. Comparable accidents occurred at sites managed by other operators, whether in France (ARIA [169](#) and [31082](#)) or abroad (ARIA [22278](#)): the same product (sulphuric acid), same type of equipment (storage tank), same cause (acid corrosion of the metal and gas ignition by a relatively weak energy source or by heat emitted during hot work for example). Available accident records also contain many cases of hydrogen explosions due to the corrosion of metal containment around facilities (tanks: ARIA [16467](#), [24977](#) and [28569](#); pipelines: ARIA [29864](#); reactors: ARIA [2301](#) and [34921](#)) in the presence of other acids.

Along the same lines, too many explosions still occur involving storage capacities containing combustible atmospheres during hot work on industrial sites, in France (inflammable vapours: ARIA [177](#), [1960](#), [4869](#), [5232](#), 8988 and [12038](#) / hydrogen: ARIA [23705](#) / dust: ARIA [8781](#), [13357](#), [21241](#), 27280 and 31588) and abroad (inflammable vapours: ARIA [120](#), 7635, [11345](#), [21737](#), 22998, [25087](#), [33574](#), 34602, [35371](#), [38415](#), [38557](#), [38595](#), [38596](#), [38599](#), [38600](#) and [39076](#) / hydrogen: ARIA [22278](#) and [27273](#)). The scenario always remains more or less the same: works are carried out by welding or grinding on a storage container even though verifications of the potential for atmospheric explosion inside and adjacent to the structure have not been conducted either prior to or during the works, or such verifications had not been adapted to the risks present (in terms of location and frequency), or else the facilities had not been cleaned of dust beforehand (ARIA [8781](#) and [21241](#)). Given its seriousness and recurrence rate, this problem has given rise to the publication of many documents and videos as part of awareness-building campaigns (combustible gases [3], dust [4]). It is also quite striking to observe that at the same site and just 8 days before the sulphuric acid tank explosion, hot work (involving grinding) performed by a subcontracted firm had accidentally ignited a fire in a storage basin containing hydrocarbon sludge ([36561](#)).

While the major accident most often occurs with a low probability at the scale of an industrial plant, this relative improbability compared to the probabilities correlated with other risks in society is still capable of biasing the perception held by actors reasoning over short time frames and in restricted environments. This distortion on both the temporal and spatial scales could lead to a partial analysis that underestimates the possibility of serious accidents occurring at a given site. The historical / cross-sectional dimension is applicable to this context, in considerably widening the pool of experience to speed progress at lower cost by incorporating the experience gained from managing difficulties previously encountered by other actors.

Although the use of feedback seems complicated and costly, its contribution to installation safety is extremely valuable: feedback enables identifying and preventing accidental situations that cannot be detected by any other means. Both the internal and external dialogue required to manage feedback also produces indirect contributions, in the technical, economic and social arenas thanks to the resulting correlations and high-quality decisions. Feedback offers a powerful tool towards achieving all of a company's strategic objectives: not just safety, but also costs and productivity.

Implementation of this feedback approach however remains highly individualised from one activity to the next and from one group or establishment to the next. The underlying organisation is now highly sophisticated in some cases, while remains in its very nascent stages or follows no standard protocol in other cases. It is a common assertion for those entities and individuals that have experienced a serious accident to be the most dynamic behind this effort, since the cost of the accident often turns out to be much greater than the cost of prevention. The room for progress still appears to be substantial.

The conditions for achieving progress apparently lie in the following :

- A drive demonstrated by the company's top management that motivates employees and subcontractors ;
- A culture that permeates the professionalism of actors, who are encouraged to rely upon their daily experiences as a source of instruction and guidance in how to manage accidents, incidents and basic deficiencies (see provisions in the SEVESO Directive relative to overseeing the integration of feedback into the safety management system) ;
- An organisation and methods suited to each sector and each company, making it possible to observe, collect, prioritise and process the events ;
- A setting that encourages actors to recognise the benefit of involvement in the feedback approach (emphasis on the positive effects, closer contact with the field). Actual benefits often go beyond simple accident prevention and span a broad spectrum of risks the company may potentially face.

In the absence of unlimited resource allocations, a site operator may elect to implement this feedback approach over the long term in a way adapted to the facility's resources, which depends on whether the approach lies at the core of the safety management system and whether the key challenges have been understood by the entire company (field staff, site foremen, executive management). In this pursuit, the guide published in French by the SPPPI PACA agency proposes a methodological tool for the simple implementation of an event-based feedback system (from incidents or accidents) in small-sized entities [5].

Bibliography :

- [1] BARPI - Use of feedback to improve the level of risk prevention in classified facilities, September 2007.
- [2] INERIS - The organisational failures of feedback, December 2009.
- [3] U.S. CHEMICAL SAFETY BOARD (CSB) - Seven Key Lessons to Prevent Worker Deaths During Hot Work In and Around Tanks, February 2010.

CSB film: "Effective Hazard Evaluations and Gas Monitoring Procedures around Storage Tanks", June 2010.
- [4] BARPI - Work carried out in silos containing plant products, Hazard!





INRS-ATEX - Application of the regulation relative to explosive atmospheres: Methodological guide





MEEDDAT - State-of-the-art guide on silos for application of the Ministerial decree relative to the risks presented by silos and storage installations containing cereals, grains, food products or any other organic product releasing combustible dust, Version 3, 2008.





CSB film: "Combustible Dust: An Insidious Hazard", July 2009.
- [5] SPPPI-PACA - Good practice guide: Feedback on industrial safety for small and medium-sized enterprises, November 2008.





Accidents whose ARIA number has not been underlined are described on the Website :





www.aria.developpement-durable.gouv.fr





     **ARIA 120 - July 7th, 1989 - THE NETHERLANDS - FARMSUM**
 20.59 - *Manufacturing of other chemical products n.c.e. (not classified elsewhere)*
 Inside a molecular sieve plant, an ammonia tank was placed back into service after welding a new bottom ; afterwards, the evening shift carried out filling tests without making note in its end-of-shift report. During the next shift, a new series of repairs were conducted on the tank, which was assumed to be empty. When grinding of a pipe, sparks caused a deflagration of the confined ammonia vapours along with the ejection of the tank bottom a distance of 60 m against one of the site's administrative buildings. A hissing sound prior to the explosion alerted employees, and as a result none were hurt. The tank had contained 50 litres of 25% ammonia.





     **ARIA 169 - 09/08/1989 - 69 - SAINT-FONS**
 20.59 - *Manufacture of chemicals n.c.a.*
 Grinding operations were scheduled on a tank having stored sulphuric acid. All operation procedures (neutralisation of residual sludge with carbonate, measurement of oxygen and inflammable gases at various points) were properly carried out. At the start of the operation, a deflagration occurred inside the tank. Casualties include one death and two cases of serious injury. The tank was partly destroyed. The explosion occurred due to the presence of hydrogen (100 g) in a dead area where no measurements were taken. The hydrogen resulted from the corrosion of the iron tank under the action of sulphuric acid.

     **ARIA 177 - February 2nd, 1989 - 60 - VILLERS-SAINT-PAUL**
 20.14 - *Manufacturing of other basic organic chemical products*
 An explosion was caused by welding work carried out by a subcontracted firm on a 1,000-m³ benzene tank, with a toll of 1 death and 2 injured. The tank was lifted and ejected outside of the facility. No damage was observed beyond the site boundary. A judicial investigation was carried out to determine the exact circumstances of this accident.

     **ARIA 535 - November 28th, 1988 - UNITED STATES - KANSAS CITY - MISSOURI**
 42.2 - *Construction of utility networks and lines*
 An arson fire and a 15-tonne explosion of ammonium nitrate occurred on a highway worksite. This first explosion was followed by a second one that blasted 7 tonnes of the same product ; 6 fire-fighters were reported missing, and another person was injured. Window panes were shattered in a radius of 15 km.











     **ARIA 1960 - May 21st, 1990 - 06 - GRASSE**
 20.42 - *Manufacturing of perfumes and cosmetics*
 In a perfumery producing food flavouring products, an explosion occurred on a 25,000-liter tank containing ethyl alcohol, causing 1 death and 2 injuries. The plant had to be evacuated. Welding work was found to be the source of this accident.

     **ARIA 4869 - November 23rd, 1993 - 77 - FRESNES-SUR-MARNE**
 06.10 - *Crude oil extraction*
 A series of explosions detonated and a fire broke out in a crude oil storage facility connected with a production well (11 m³/day at 60% water, 12 Nm³/tonne of gas). Three of the five 37.5-m³ capacity tanks exploded, 2 of which were blown 10 m away from the retention basin. Welding work undertaken by a local firm and performed without any written guidelines provided for the partially drained tanks that had not been degassed were responsible for this loss. One of the technicians was ejected 30 m and died on the spot, while a second was seriously injured (issuance of a 2-month work stop order). An employee working at a neighbouring quarry who came to offer assistance was slightly hurt. The 23.3 m³ of crude remaining in the separation tank were extinguished within 45 minutes by a response team of 70 fire-fighters. No hot work permit had ever been issued.

     **ARIA 5009 - October 29th, 1987 - 44 - NANTES**
 46.75 - *Wholesale of chemical products*
 At a warehouse storing unknown contents, the self-sustaining decomposition of a stockpile of 850 tonnes of fertiliser NPK 15-8-22 delivered five days earlier caused the formation of a cloud 10 km long heading westward ; in this cloud, the presence of nitric acid and chlorine were detected. The ORSEC plan for dealing with crises was activated; 200 fire-fighters, 627 police officers , 489 gendarme officers, 356 soldiers, 200 emergency responders and over 1,000 municipal employees were mobilised. An extensive evacuation plan spanning 7 municipalities located downwind of the warehouse was implemented. The incident was eventually controlled after 7 hours of emergency intervention. The human toll amounted to 3 intoxicated employees, one of whom was placed in 24-hour observation at the hospital. Even though the overall evacuation measure applied to a population of 70,000, the actual number of individuals moved for a period of 9 hours during the crisis was evaluated at 38,000. The LOIRE River was only minimally polluted considering the widespread dilution of fire-fighting water.

As a result of both their transport conditions (in the hold of a ship that had previously stored wheat) and storage conditions (on a bed of sawdust), the fertilisers responsible for this accident were placed in close contact with organic matter, whose concentration at certain spots could have been quite high. Moreover, the site's obsolete electrical installation was partially to blame. The combustion zone began at a point directly aligned with the electrical cables that were dangling underneath the aboveground system for handling stored substances; the cut ends of these cables were probably buried in the mass of fertiliser. Under these conditions, ignition was likely initiated in the depths of the fertiliser pile, immediately adjacent to both the mass contaminated by sawdust and the buried electrical conductors. The fire then spread by means of self-sustaining decomposition of the fertilisers.

This accident still would not have reached such proportions had an efficient response been organised as of the initial detection of heat accumulation.

          **ARIA 5232 - May 3rd, 1994 - 31 - PORTET-SUR-GARONNE**

42.13 - Bridge and tunnel construction







In a bituminous materials depot run by the BTP company and comprising 17 tanks, one of which contained hydrochloric acid, the vapour space of a vertical container filled to half its "cut-back 0/1" capacity (i.e. 18 tonnes of liquefied bitumen with 40% kerosene / flash point < 55°C) exploded around 2:30 pm, during the installation of walkways and guardrails between the tanks. The container was thrust some 20 metres and the 2 employees, who were already at the scene with a trimming machine close to the tank vent, died after being thrown a 30-m distance. The liquefied bitumen spread causing a fire and, less than 5 minutes later, the explosion of an empty, non-degassed bitumen container that wound up on the roof of a depot building some 10 metres away. Traffic was halted on the adjacent street leading to a shopping centre. Local residents and customers of a nearby shop, as well as all bystanders, were evacuated. The fire also ignited a row of trees planted on the property line; the emergency response team's quick arrival on the scene enabled containing and extinguishing the blaze.

The two containers broke at the level of the shell / bottom interface. The HCl storage capacity melted when exposed to the effect of heat ; moreover, 12 other tanks and the roof of the adjacent production unit were damaged. 7 company vehicles were destroyed. The retention basins were also extensively damaged. Total property loss was valued at 5 million francs.

During its investigation, the classified facilities inspection authority found that the operating instructions posted near the depot made no mention of prohibiting presence in the vicinity of any installation with devices capable of generating sparks or hotspots, and moreover that no risk analysis had been conducted prior to these works. Instructions were only being transmitted verbally, and lastly the site operator was unfamiliar with the combustibility characteristics of "cut-back 0/1", which is a Category 1 combustible liquid.











The initial inflammation was most likely triggered by a spark or hotspot during onsite works, which then ignited a vapour space outside the "cut-back 0/1" tank. The resulting vapours were able to "form" either at the end of the 6-m long hose set into place by workers to redirect vapours to the bottom of the container, or at the hose-vent junction (had the hose not been perfectly sealed), or at a tank cover opening designed for tank instrumentation (level measurement cable). After ignition of the vapours in an unconfined space, the flame penetrated into the tank causing the explosion and ejecting the tank.

Subsequent to the accident, the site operator proceeded by : installing a new depot with a storage capacity of less than 150 tonnes of emulsion, published a safety manual for nationwide dissemination, and organised a safety training course for site personnel. The installation was definitively closed on October 5th, 2007.

          **ARIA 6268 - December 13th, 1994 - UNITED STATES - PORT NEAL**

20.15 - Manufacturing of nitrogenous products and fertilisers

An explosion occurred at 6:10 am inside an ammonium nitrate production unit (employing 119). A missile projectile during the explosion tore a 15-cm opening in a 3,800-m³ ammonia storage facility, producing a leak flowing out at a rate of 30 kg/s. The plant's external emergency plan was activated. Within a radius of 30 km around the site, some 2,500 residents were evacuated until the evening, following dispersion of an ammonia cloud reported to have spread as far as 15 km. The human toll came to 4 deaths, all plant personnel, and 18 injured (2 among the general public outside the plant). The explosion damaged dwellings and other buildings beyond the site boundary. A high-voltage power line crossing the state of Missouri was also affected, and electricity supply service to a neighbouring state had to be cut for awhile.

          **ARIA 8781 - October 18th, 1982 - 57 - METZ**

11.06 - Malt production





An explosion occurred at 2:15 pm inside the materials handling tower of a silo located at a malt house during repairs of the facility's slabs and installation of a dust removal system, performed by 3 subcontracted employees. The filling ratio of silo cells was set at 12,000 tonnes compared with a theoretical capacity of 15,000 tonnes. A second more powerful explosion was felt a few seconds later, causing the tower to collapse along with 8 of the 14 cells containing barley and malt. Flames could be seen at various spots inside the silo boundary; 12 workers, including malt house personnel, subcontractor employees and lorry drivers (perhaps clients) were killed and buried under the rubble and debris; three others sustained injuries, one of whom was in serious condition. Considerable rescue efforts were deployed in the hope of finding survivors (a response team of 600 in all were dispatched to the site, including canine units and two cranes able to lift 150 and 300 tonnes, respectively). The instability of residual structures plus the tremendous pile of concrete rubble and spare equipment covered by grain strewn by the explosions severely complicated this rescue effort; the last victim was not removed from under the debris until 5 days later. Grain combustion raged another several days over the upper part of the cells that had not collapsed. Property damage, confined to the silo and its immediate surroundings over a distance approximately equal to the height of the installations, was assessed at 70 million francs (1982 currency value). The barley and malt debris disposed at the dumpsite of a former gravel pit wound up polluting the MOSELLE River alluvial fan for 2 years within a water extraction zone.

The cause and exact sequence of the explosions could not be precisely determined. The most likely hypothesis is that an initial explosion in the tower generated by the combination of an ignition source introduced during the works (or a careless smoker) and an explosive atmosphere caused dust to scatter inside the facility, leading to a second explosion throughout the tower and extending into the upper gallery and spaces between cells, where the collapses were eventually observed (outer row cells of the handling tower). The investigation also indicated the site's major dust accumulation problem, along with inadequate technical equipment (a complex dust removal system lacking efficiency features, absence of vents, etc.), organisational deficiencies (no practice of circulating memoranda relative to installation safety, no written instructions for carrying out works, no hot work permitting procedure) and, lastly, the workforce's general underestimation of the fire and explosion risks.







          **ARIA 11145 - August 30th, 1972 - AUSTRALIA - TAROOM**





49.41 - Road freight transport

A small electrical fire broke out inside the engine of a lorry transporting 18.5 tonnes of ammonium nitrate, packaged into 510 polyethylene bags and intended for explosives manufacturing. The vehicle's cabling proved to be faulty. The fire reached the lorry's trailer, where 7 tonnes of ammonium nitrate melted and spilled onto the road over a distance of 110 m. More than ten minutes after the fire broke out, the load being hauled exploded, killing the lorry driver and 2 neighbours in the vicinity who had shown up to offer assistance. Their bodies were thrown some 30 m. Lorry debris could be found as far as 2 km from the scene. A crater 10 m in diameter and 1 m deep was formed. This explosion could be explained by the liquefied state of the nitrate and its contamination by the carbon black generated from combustion of the lorry's tyres.







    **ARIA 11345 - March 12th, 1997 - ITALY - PESCHIERA DEL GARDA**





37.00 - Wastewater collection and treatment







       At a municipal wastewater treatment plant, an explosion occurred while repair works were underway inside a concrete silo dedicated to biogas fermentation and production. Residue from gas and welding operations were at the origin of this accident. Two workers were ejected from the silo and died on the spot, while a third fell to the bottom of the structure and sustained serious injuries. The silo roof was also blown off.





    **ARIA 12038 - December 24th, 1986 - 13 - CHATEAUNEUF-LES-MARTIGUES**

19.20 - Oil refining







       During a welding operation, an explosion occurred on a tank containing heavy fuel oil killing one and seriously injuring another.

    **ARIA 12271 - April 15th, 1947 - UNITED STATES - TEXAS CITY**

       *50.20 - Maritime and coastal freight transport*
At a port facility, a cargo vessel already containing miscellaneous materials was loaded with fertilisers (ammonium nitrate serving as the base ingredient). The product, packaged into 45 kg bags, resembled small brown grains (composition : 32.5% nitrogen, 4%-5% mineral load, and 1% a coating mix made from Vaseline and resin). During the loading phase, 1,400 tonnes were placed in Hold 2 and another 800 tonnes in Hold 4. The next morning at 8 am, after smoke was detected in Hold 4, a small quantity of water was discharged onto the presumed firebox before reclosing the hold with restricted ventilation (by means of blocking orifices). The situation worsened, as pressure forced open the orifices through which a reddish orange smoke was escaping. At 9 am, the hull of the ship was already burning hot. A very violent explosion ensued at 9:12 am. Projectiles, quite large in some cases, were found far from the accident site (e.g. a 1.5-tonne anchor was blasted into a refinery more than 3 km away!). The explosion caused a tidal wave on shore. An adjacent ship, loaded with sulphur and ammonium nitrate (961 tonnes) also caught on fire. The inflamed vessel could be towed around 50 m away from the coastline out to sea, where at 1 am it exploded. The accident's toll was approximated at 581 dead and 3,500 injured. Damage to the port and neighbouring dwellings was extremely severe. Glass panes far and wide were shattered. Fuel reserves ignited following the second explosion, as did a number of silos. Five days after the disaster, fires were still burning out of control in the city.







    **ARIA 13357 - May 19th, 1998 - 79 - PAMPROUX**





10.9 - Manufacturing of animal feed

       In a cattle feed factory, welding operations on the roof of a 140-tonne capacity storage cell that was holding 40 tonnes of rape oil meal were the source of an explosion occurring in the vapour space of the enclosure. The metal roof as well as all roofs made of everite tiles on the adjacent buildings were blown off. The welder, who was employed by a subcontractor, was slightly hurt. Total damages were estimated at 30,000 francs. The terms of the hot work permit granted for this operation lacked sufficient precision. Administrative authorities logged the event.







    **ARIA 14373 - September 21st, 1921 - GERMANY - OPPAU**

20.15 - Manufacturing of nitrogenous products and fertilisers







       At a chemical plant, an explosion destroyed a building storing 4,500 tonnes of a 50-50 composition of ammonium sulphate-nitrate, forming a crater 90 m wide, 125 m long and 20 m deep. Shortly thereafter, a series of fires broke out on the facilities, caused by a domino effect, amidst other explosions of lesser intensity. Heard more than 275 km away, the detonation created panic among the local population. A dark green cloud blanketed the sky over the region, and the telegraph and telecommunications infrastructure was destroyed. The extent of damage reached several tens of km from the accident site.
The result of this disaster was dramatic: 561 dead, 1,952 injured and over 7,500 left homeless. Nearly 80% of the buildings in the city of Oppau were levelled ; considerable destruction was also observed in the towns of Ludwigschafen and Mannheim. In Heidelberg, about 30 km from Oppau, traffic was prohibited due to the large-scale presence of glass debris on road pavements. The magnitude of property damage and great numbers of victims complicated the task of emergency services. During these troubled times, politically, socially and economically speaking, it would take 3 years to remove all remnants of the accident. The difficult investigation subsequently launched lasted more than 2 years. A report published in 1925 ultimately established that the accident occurred following a controlled blast carried out in the ammonium sulphate-nitrate stockpile for the purpose of disaggregating fertilisers clumped into a mass (a hygroscopic mix). Just a few months before the explosion, the manufacturing process had undergone modification in order to yield dryer fertilisers (2% humidity instead of 3%-4%), with a lower apparent nitrate density, yet making the final product more explosive. Moreover, the composition of the 4,500-tonne pile of ammonium sulphate-nitrate mix was likely to have been quite heterogeneous, with some zones containing a higher concentration of ammonium nitrate. The explosiveness of such a mix actually increases rather considerably should the proportion of ammonium nitrate rise from 50% to 60%. So when the blast was detonated, an enriched ammonium nitrate mix could ignite, causing the neighbouring portions of mix with a 50/50 split to explode; the detonation did not immediately spread to the entire stockpile, limiting the explosion to just 10% of the total mass (i.e. higher-density zones were spared).
During preliminary testing conducted in 1919 before production start-up, the operator had concluded that mixes of ammonium sulphate / nitrate at concentrations of less than 60% ammonium nitrate were non-explosive. These fertilisers were subsequently treated as a non-hazardous material. When the industrial process was modified in 1921, no additional tests were performed on the resultant mix. This accident highlights that a modification with apparently minor consequences on the end product properties can indeed substantially increase sensitivity to triggering an explosion.







    **ARIA 14732 - July 28th, 1947 - 29 - BREST**







50.20 - Maritime and coastal freight transport

       A docked Norwegian ship held a total of 3,133 tonnes of bagged ammonium nitrate grains in cargo holds 1, 3 and 5 ; in the deck cargo area above these holds, combustible or inflammable substances were being stored, including : fuel oil, paints, lubricants, rubber, polystyrene, paraffin, methyl ethyl ketone, and butyl alcohol. Around 12:30 pm, a white smoke turned yellow in exiting a venting tube from Hold 3. The vapour extinction system was needlessly activated (introducing heat and oxygen present in the nitrate). Red smoke was seen in the exhaust from the hold's other venting tubes. A low rumble could be heard. Emergency workers opened the vibrating access panel. The fire was growing in intensity, with explosions ejecting cargo onto the ship's deck or in the water. Flames reached







some warehouses along the dock (triggering a domino effect). A tugboat towed the crippled ship away from the port, though with its superstructures already ablaze, the vessel ran aground at 2 pm on a bank located too close to the city. At 5 pm, the fire was out of control, as barrels of oil stored in Hold 2 ignited and flames began spewing from Hold 1, which was storing 739 tonnes of nitrate. The boat was now adrift; an explosion at 5:25 pm killed 26, while hundreds of others were hurt. A 5-m wave engulfed the docks, and the city endured a bombardment of material projectiles, causing major damage (the fire spread to a gas plant and oil depots, and elsewhere). Glass panes were shattered up to 70 km from the blast, and ironwork was found as far as 22 km away. Paraffin and other molten materials had seeped into the nitrate stock.







       **ARIA 16467 - August 10th, 1999 - 76 - FECAMP**







       *20.17 - Fabrication of synthetic rubber*







       At a rubber factory, an explosion occurred inside a lubricant container filled with 18 tonnes of tri-(nonylphenyl) phosphite (TNPP or TNPA). This tank was typically stirred and maintained at 45°C ; moreover, the heating circuit routed to the container had broken down 7 days earlier. With the polluted TNPP scheduled for disposal, the accident occurred during a sawing operation to remove the walkway interfering with the manhole opening. The TNPP substance underwent hydrolysis in contact with water leaking via the broken coil ; the resultant phosphoric acid corroding the steel on the container caused hydrogen to form. The relatively slow hydrolysis reaction was no doubt catalysed by metal particles (rust, etc.). A technician was seriously injured due to a fall. The new installation would obviously be ventilated and protected from rainfall or any other potential water intake. A heating belt (with $T_{max} < T^{\circ}$ of TNPP degradation) replaced the coil, and a posted instruction reminded workers of the product's sensitivity to water.







       **ARIA 17972 - April 29th, 1942 - BELGIUM - TESSENDERLO**

       *YY.YY - Undetermined activity*

       150 tonnes of ammonium nitrate contained in a silo exploded, causing several hundred deaths and major property damage. The explosion was caused by a blast detonated with explosives, which was part of customary practice for masses of aggregated nitrate. Such a practice using explosives had in fact been commonplace at this plant for the purpose of disaggregating raw potassium chloride; on the day of the accident, an unsuspecting worker thought the same technique could be applied to ammonium nitrate.







       **ARIA 17974 - July 26th, 1921 - POLAND - KNUROW (KRIEWALD)**







       *20.51 - Explosives manufacturing*

       In a company whose activity consisted of producing a range of products including explosives, 30 tonnes of ammonium nitrate exploded, following disaggregation of a bulk nitrate load by means of blasting. A funnel-shaped crater 20 m in diameter was dug into the ground. The human toll came to 19 deaths.







       **ARIA 21241 - September 4th, 2001 - 35 - MONTAUBAN**

       *10.91 - Manufacturing of farm animal feed*

       In a factory specialised in animal feed, an explosion followed by a fire occurred in one of the silos for storing crushed raw materials, where an employee with a subcontracted firm was performing an arc welding operation. The full set of installations were shut down as an emergency measure, and the seriously injured worker was evacuated from the site. The continuation of filling operations on the other containers had caused dust to spill into the silo undergoing repairs via a rotary drum connected to the network of silo feed pipes. The air-dust mix exploded in contact with the welder's electric arc, which was included in the tasks assigned to the subcontractor. The classified facilities inspector's analysis of the prevention plan plus the nature of operations conducted preliminary to these works revealed, on the one hand, noncompliance with several procedural steps that had proven inadequate ; on the other hand were organisational shortfalls or lapses relative to the control, knowledge and execution of these operations. More specifically, the hot work permit submitted by the technician performing these safety-related works eliminated all 2nd-level controls. The site operator was issued an injunction to revise facility procedures.

       **ARIA 21737 - July 17th, 2001 - UNITED STATES - DELAWARE CITY**

       *19.20 - Oil refining*



       While a subcontractor was performing hot work on the renovation of a walkway placed above Tank 396 at an oil refinery, Tank 393, containing a mix of sulphuric acid (H₂SO₄) and so-called "spent" H₂SO₄ hydrocarbons, exploded around 1:30 pm. The affected tank rose and then collapsed towards the north, causing the walkway to fall and leaching 1,000 m³ of H₂SO₄. The force of the explosion damaged Tank 396, which in turn released 1,332 m³ of H₂SO₄. The acid, whose surface was on fire by the burning of inflammable materials, overflowed the retention facilities and wastewater network, before spreading into the site's aisles. The operator estimated that 375 m³ spilled into the DELAWARE River, killing some 2,500 fish and 250 crabs. The American Environmental Protection Agency (EPA) estimated the total volume of H₂SO₄ lost at 4,164 m³.



The toll stood at 1 death and 8 injured by eye and lung burns as well as nausea from the vapours. Due to the acid contamination and quantities remaining in the intact tanks, emergency response teams were not able to enter the zone until August 17th, i.e. 32 days after the accident. The search for the dead worker's body was called off on September 18th. The Federal agency assigned to report on chemical accidents (Chemical Safety Board, CSB) conducted an investigation.



The Board's final report pointed to several areas of negligence. Tank 393 had been converted from storing "clean" H₂SO₄ to the "spent" category in 2000 without any precautions taken. As opposed to "clean" H₂SO₄, the "spent" form of H₂SO₄ contains hydrocarbons, and inflammable vapours are capable of forming, thus requiring a CO₂ inerting treatment. On Tank 393, this system consisted of a simple rubber pipe inserted into the tank and delivering only a small flow of CO₂. The tank also displayed a number of holes caused by corrosion, through which inflammable vapours were able to escape; moreover, the most recent inspection dated back to 1996.



The refinery owner was aware of these shortcomings, yet nonetheless issued a hot work permit. Subcontractors were not informed of the presence of such vapours and only initiated gas detection as of the morning of the explosion, upon arrival at the site. They should have repeated controls at the beginning of the afternoon, especially given that the temperature had already risen. Also, they had not yet installed protection against flying sparks, in failing to comply with permit specifications.



Both the federal government and the state of Delaware filed lawsuits. The operator paid €370,000 in pollution cleanup measures, another €6 million on safety upgrades, €3.4 million for bodily injuries, €130,000 to reimburse public rescue services and €10.2 million in fines for ecological violation.



  **ARIA 22278 - 10/10/1985 - ITALIE - RIPALTA ARPINIA**
 20.15 – *Manufacture of nitrogenous products and fertilizers*
 In a fertilizer production plant, a sulphuric acid (H₂SO₄) container exploded while two technicians were performing oxyacetylene cutting operations in the vicinity to remove plates fixed by nuts. The two technicians died in the explosion. The capacity was projected across the workshop and destroyed two other H₂SO₄ containers whose contents spilled onto a retention tank. The acidic cloud evaporated from the spill and dissipated into the atmosphere without any effects on the residents. Sodium carbonate was sprayed to neutralise the acid and avoid corrosion of the ammonia pipes passing through the retention area. The explosion resulted from the ignition of the hydrogen accumulated in the tank by the oxyacetylene flame. Hydrogen was formed by the corrosion of the steel tank by the sulphuric acid due to insufficient maintenance of the storage equipment.







  **ARIA 23705 - January 1st, 1989 - 76 - GONFREVILLE-L'ORCHER**
 20.16 – *Manufacturing of basic plastics*
 In a chemical plant, a hydrogen (H₂) explosion occurred in an empty 100-m³ tank of sulphuric acid (H₂SO₄). Built in 1973, this storage container was lifted 5 cm, yet its anchorages were able to resist the blast. The tank was repaired by installing an angle bracket type of reinforcement at the level of the bottom/shell junction and replacing the 4 threaded anchorage pins. This accident could not be accurately dated. A similar accident in 2009 would once again implicate this same tank (ARIA 36628).

  **ARIA 24977 - 02/07/2003 - 91 - MORSANG-SUR-SEINE**
 37.00 – *Wastewater collection and treatment*
 Inside a water treatment plant, an exothermic reaction caused an explosion on a retention basin and the ensuing release of acid vapours. A 50-m safety perimeter was established around the plant, with the closest residences situated 300 m away. Some fifty firefighters identified the leak source; the gases formed could escape via the ventilation system connected to the premises where the explosion first happened. The products contained in the destroyed tank were recovered in the surrounding retention basin. They were then pumped and discharged to an external treatment facility. The accident exerted no impact on water production, which could proceed using the two intact remaining trenches and moreover no discharge was released into the natural environment. The explosion occurred within a steel tank located in the basement of the site's storage building; this tank served as temporary offset retention for the storage of sulphuric acid (H₂SO₄) during restoration of the site's normal retention capacity. The accident might have been due either to the sudden arrival of acid into the tank, thereby triggering a violent reaction with the steel followed by hydrogen production, or to a violent reaction caused by a mix of H₂SO₄ with a product contained in the basin or with a product discarded into the drain hole by a third party.

  **ARIA 25087 - July 4th, 2003 - UNITED STATES - FRAMINGHAM**
 42.11 – *Road and highway construction*
 An explosion occurred at a factory specialised in manufacturing tar, on an asphalt tank. An employee was welding with a blowtorch and wound up being ejected some 10 metres high; he was seriously hurt and hospitalised in critical condition. A second employee suffered burns and was also taken to hospital, as was a fire-fighter distressed by the heat. The explosion shook several homes and plants in the vicinity. More than 20 fire-fighters were needed to control the incident after 1 hour of battling the blaze by spraying foam.

  **ARIA 27273 - June 8th, 2004 - JAPAN - AKITA**
 20.20 – *Manufacturing of pesticides and other agrochemical products*
 At an agrochemical plant, an explosion occurred near a drained hydrofluoric acid tank as 4 employees were welding on adjacent pipelines. One of the technicians died as a result of his burns, while the other 3 sustained injuries. According to the operator, air pollution measurements recorded around the plant did not indicate the presence of any toxic products, and moreover the impacts on both the environment and local residents would be minimal. An investigation was launched to determine this accident's causes. The presence of hydrogen might have been the source. Except for the unit already shut down for maintenance, plant activity was not interrupted.

  **ARIA 28569 - October 26th, 2004 - 47 - LAVARDAC**
 33.20 – *Installation of industrial machines and facilities*
 An explosion occurred in a facility dedicated to the renovation and maintenance of boilers during repair work on one such boiler. A technician had previously de-scaled the device using hydrochloric acid before proceeding with the neutralisation step with soda and draining the passive acid introduced. The significant scaling on the boiler required a second acid injection, followed by welding work, but this time without draining the boiler. Hydrogen emitted by a metal + acid reaction was the cause of this accident. An employee wound up in hospital in a coma. Labour inspection authorities noted that operating conditions were not favourable towards environmental protection, i.e. failure to control discharge pH, absence of written procedures.

   **ARIA 29864 - May 21st, 2005 - 38 - CHAMPAGNIER**
 20.13 – *Manufacturing of other basic inorganic chemical products*
 A pipeline used to transport gaseous chlorine (Cl₂) exploded between a chemical platform (run by the producer) and an elastomer manufacturing site (user).
 The pipeline, built in 1961 for the transport of hydrochloric acid (HCl), had been operated since 1986 for transferring deoxygenated and dried Cl₂. 200 mm in diameter and 3,600 m long, made of painted steel, heat-insulated and outlined over the upper external part by a heating tube via the skin effect, this pipeline was being operated at 4 bar relative pressure and 30°C. As of the previous day, production had been shut down for a 10-day maintenance period, bringing the pressure inside this chlorine pipeline down to 0.25 bar.
 The explosion occurred outside the user's site 150 m from the delivery point; the pipeline was ruptured in 4 spots and showed traces of internal shock waves over a 70-m length. The explosion produced no victims, despite considerable pipe debris being strewn over a 150-m radius. The quantity of Cl₂ emitted into the environment was evaluated at 475 kg. The damage identified (spiral rupture, pressure wave, etc.) characterised the detonation power of the explosion. The physical impacts were significant on the 4 other pipelines (100-mm diameter) of the aboveground rack: 2 nitrogen pipes (13 bar, 2,000-3,000 m³/hr) were deformed, yet remained sealed. Their pressure was brought down to 10 bar, the damaged oxygen pipe (10 bar) had been







drained, and the last disused pipe contained nitrogen (N₂) at atmospheric pressure.

An H₂ / Cl₂ explosion caused the accident. The formation of H₂ (20%) can be explained by a combination of several elements: accidental introduction of humidity into the pipe during a previous maintenance operation, leading to hydration of the ferric chloride present; a crystalline phase change in the deposit (according to the operator, due to excessive heating of the pipe, i.e. 80° to 90°C) and thus facilitating attack of the steel (by hypochloric acid) as well as H₂ formation; heating resulting from a drop in electrical supply of a temperature sensor, following a cable break at the user's site during inappropriate handling of one of the structure's protective slabs 3 days prior.

The proportion of hydrogen (20%) released into the gaseous Cl₂ contained in the insulated pipeline at each end, under low pressure (0.25 bar), gave rise to an explosive mix that a very small amount of energy could trigger (i.e. roughly 10 micro-Joules would be sufficient for ignition).

The operator cleaned the interior of the structure (2.5 to 3 tonnes of mineral and organic residue were extracted) and made plans to: insert temperature probes every 500 m along the length with both low and high safety levels; revise and secure the electrical layout; and perform regular endoscopic controls.

ARIA 31082 - 26/11/2005 - 69 - PIERRE-BENITE

      **20.13 - Manufacture of other basic inorganic chemicals**

An explosion occurred in a chemical site causing the cover of a 99.2% sulphuric acid tank (filled to 300 t of its total 1500 tonne capacity) to open partially. The cover opened along the circumference of the tank at the dome / shell fitting. The POI (internal emergency plan) was triggered. No emission or leak was reported except for the emission of fumarole at the opening. No environmental or human consequences were reported. Material damage was limited to the equipment located above the tank (acid supply pipes, air pipe going to the dryer, walkway, steam pipe, etc.). The presence of hydrogen (a few dozen grams), generated by the corrosion of steel by the weak acid was responsible for the explosion. The accident was further to a series of incidents in the unit manufacturing H₂SO₄ through the absorption of SO₃ in packed columns: two successive piercing incidents of the water/acid heat exchangers of the transfer columns on the day before the accident caused an around 85% titer to flow into the acid storage tank (1st incident), followed by acid with a practically zero titer (2nd incident). Before the explosion the tank contained a heterogeneous mixture with a weaker surface titer. The explosion occurred 1 hour and 15 minutes after the tank had been agitated. The ignition of H₂ (requires very low energy) was probably electrostatic. The two piercing incidents of the heat exchanger were due to a phenomenon of corrosion by pitting near the seam welds on the side of the cooling water. Modification of the anti-legionella biocide treatment since the previous year may have favoured the phenomena of corrosion by pitting. The use of liquid bleach instead of bromine greatly increased the oxidising power of water and thus lowered the starting temperature of corrosion pitting. Decreasing the speed of passage of water (on account of the drop in the workshop activity for a long period) contributed to increasing the temperature of the medium, is another aggravating factor for the accident. The measures taken include water treatment (temporary use of a non-oxidising biocide and study of a continuous chlorine-bromine treatment), detection of any abnormal arrival of water in the process (temperature detector with alarm, titrators), operating procedures (prohibition on adding weak acids to storage tanks).

ARIA 33574 - June 5th, 2006 - UNITED STATES - RALEIGH







      **46.71 - Wholesale of fuels and ancillary products**

An explosion occurred during installation of a connection between 2 hydrocarbon storage tanks in an oil field depot. During welding, sparks ignited the hydrocarbon vapours escaping from a nearby open pipe. Subcontracted personnel were assigned works on the 4 interconnected tanks: contents of Tank 4 spilled into Tank 3, whose overflow led to Tank 2 and then to number 1. Workers removed the hatch at the base of the 4th tank to drain the crude oil residue contained inside. After rinsing with water, they allowed the hydrocarbon vapours to evaporate for several days. On the day of the accident, one of the workers inserted a blowtorch to place the oxy-acetylene weld inside the hatch, then in the vent on the opposite side of Tank 4 in order to verify the absence of combustible vapour. The 4 workers proceeded by climbing a ladder placed on Tanks 3 and 4. Shortly after they began their tasks, fire broke out at one end of the pipeline at Tank 3, then spread to Tank 2 via the overflow pipe, as the tanks exploded causing flames to jump over 15 m high. The covers of both these tanks were torn off, one landing 180 m away. The 3 workers who had climbed onto Tank 3 died and the 4th employee, who was attached by a harness, was seriously injured. A bystander called the local emergency services, and the police were also deployed to the scene.

The risk analysis revealed many instances of noncompliance with safety procedures during the hot work, despite the availability of technical guides. A gas detector should have been introduced, as use of a welding torch was extremely dangerous. The pipe open onto the adjacent tank should have been covered or insulated before initiating the works or, better yet, the combustible vapours should have been eliminated by cleaning Tanks 2 and 3. Moreover, the subcontractors should have assembled a scaffolding rather than a ladder that needed to be held in place by wedging against Tank 3. Also, the subcontractor had not established any safety procedures for its employees, while the depot operator failed to impose such procedures.







The operator planned to develop and implement a written set of procedures so as to guarantee safe working methods for both tank cleaning and aboveground hot work.

ARIA 34921 - May 2nd, 2007 - 03 - MONTLUCON

      **20.14 - Manufacturing of other basic organic chemical products**

A blast erupted at a chemical plant during a synthesis operation involving sodium triacetoxymethylborohydride inside a 5,300-litre reactor. Around 5:30 pm, the technician observed that the acetic acid intake pipe was plugged. After opening the manhole with a wooden pole, the shop foreman dropped the stalactite of solidified acetic acid in the reactor: the resulting blast severely burned the foreman's face. The blast was caused by inflammation of the hydrogen produced from the dropped quantity of acetic acid, as the maximum amount of acetic acid introduced into the reactor was estimated by the operator at 3 kg, which led to the formation of approx. 100 grams of hydrogen in this 5,300-liter reactor. The accident had no impact either on the environment or on other shop installations.

ARIA 35371 - October 19th, 2008 - UNITED STATES - LA RUE

      **06.10 - Crude oil extraction**

Around 2:30 pm, an explosion occurred at a crude oil extraction facility killing the two employees who were carrying out welding work on top of a crude oil storage tank, which was connected to two adjacent tanks. The filling operation underway at one of the adjacent tanks caused inflammable vapours to move in the direction of the tank being welded via the breathing vent located beside the welders. The combustible cloud was ignited by welding sparks and then exploded. The investigation conducted by administrative authorities revealed that the workers (subcontractor's employees) had failed to measure the explosive potential both before and during

welding; moreover, no procedure had been adopted for hot work, nor were any jobsite controls in place for subcontractors. Lastly, the two subcontracted workers had not received any training in the risks associated with hot work.

ARIA 36561 - IC - July 27th, 2009 - 76 - GONFREVILLE-L'ORCHER

TOTAL PETROCHEMICALS FRANCE

20.16 - Manufacturing of basic plastics

At a SEVESO-rated plastics factory, fire broke out at 4:50 pm in a settling basin for hydrocarbon residue containing mainly sands, polyethylene and polypropylene pellets and heavy hydrocarbons (e.g. sewer clearing sludge), on a floor area of roughly 50 m². A thick black smoke was released and could be seen as far as the city of Le Havre. The internal emergency plan was activated, and in-house responders extinguished the blaze by 5 pm using foam, at which time the plan was lifted. The released heat flow did not reach the 2,500-m³ spherical butylene tank located 50 m from the basin, nor did it reach the 2 naphtha tanks 200-250 m away. Sparks originating from the structural work taking place on a nearby unit were the cause of this fire. A technician was cutting with a grinder (installing rebar for a future reinforced concrete wall) at a distance of 2 m from the settling basin. Following this fire, the site operator notified authorities from neighbouring towns as well as members of the Local Information and Consultation Committee.

ARIA 38415 - July 29th, 2008 - UNITED STATES - NC

17.12 - Paper and cardboard production

In a cardboard production facility, a maintenance operation was planned on the dome cover of a 25-m³ tank containing water and paper fibres. The operation was assigned to 3 employees and consisted of repairing a flange by performing a weld. An explosion occurred and ripped open the tank roof. All 3 workers were killed as a result of the traumatism suffered ; two bodies were found at the foot of the tank.

Another employee, who observed the event from a distance, was also hurt. An investigation was launched by the federal agency overseeing chemical accidents (CSB) ; their report indicated that anaerobic bacteria had proliferated in the tank containing fibre waste and wastewater, as well as in the water recycling system, due to the presence of organic waste. Site employees were not at all aware that the multiplication of anaerobic bacteria could produce combustible vapours, most likely hydrogen, and therefore did not measure the explosive potential in the tank before undertaking these works.

ARIA 38557 - June 10th, 2010 - ITALY - BRINDISI

21.10 - Manufacturing of basic pharmaceutical products

An explosion occurred around noon while welding was being conducted in a tank at a pharmaceutical products plant employing 240. The tank cover was ejected a few metres, killing a subcontracted worker, who in turn was thrown 50 m ; also, 3 employees were seriously injured (2 of whom were subcontractor employees) and 1 was slightly injured (also subcontracted). The fire-fighting crew was able to extinguish

the fire ; the local municipality, along with the provincial government and Environmental Protection Agency, were informed of the accident. The operator issued 2 press releases.

Site activity was suspended, and a judicial investigation conducted in order to determine the exact causes and circumstances surrounding the event, as well as the liabilities and eventual negligence. The subcontractor's legal representative and project manager, along with the plant director, were charged with involuntary homicide and inflicting serious injuries. According to the initial elements available, the tank might have contained process water and chloroform. The work permit on the tank had been signed by the Head of Safety. Moreover, investigators undertook a series of analyses to determine whether a substance capable of reacting and causing an explosion had not been introduced by mistake into the tank where works were taking place (perhaps not entirely empty?) ; other examinations were performed to verify whether the safety relief valve protecting the tank was obstructed or defective.

ARIA 38595 - March 31st, 2009 - UNITED STATES - ATWATER

10.31 - Transformation and preservation of potatoes

On the site of a company that was packaging sweet potatoes, 2 employees were using an acetylene blowpipe to remove a high-precision fitting from an older fuel oil tank for reuse on a new tank. During this operation, the tank exploded and seriously burned both workers over 30% to 50% of their bodies ; the two of them had to be transported by helicopter to a major burn centre.

The tank had not been cleaned or drained, and neither employee had used a gas detector. The company had not specified a procedure for work on hotspots, and no hot work permit had ever been issued. Moreover, many employees only spoke Spanish and had not received training on safety procedures and the use of gas detectors in their native language.

ARIA 38596 - October 7th, 2008 - UNITED STATES - KAPOLEI

52.10 - Warehousing and storage

On a site used to store miscellaneous products, a subcontractor was performing welding work on a walkway located above a 32,500-litre tank containing used oil. Sparks fell into and around the tank vent and ignited its contents. The tank exploded and was thrust 10 m; a fire ensued. The welder, thrown 37 m by the blast, died and 3 other employees were injured. An investigation was initiated by the fire

department. It turns out that the subcontracted workers had never been awarded a hot work permit to perform welding in this zone. The subcontracting firm declared having the impression that this type of work was authorised and moreover that the operator had already checked for gas before they arrived onsite.

ARIA 38599 - May 12th, 2009 - UNITED STATES - GARNER

52.10 - Warehousing and storage

Around 2:30 pm, subcontractors were creating an opening using a blowtorch on the mobile roof of a 10,000-m³ gasoline tank for the purpose of installing a gauge. The heat ignited vapours within the tank, which then exploded killing all 3 subcontracted employees.

An investigation revealed that the subcontractor had received from the site operator an authorisation to work in a confined space as well as a hot work permit. Moreover, gas measurements were recorded at 7 am. Yet nothing indicated that gas detection was repeated upon returning from lunch or before resuming the job.

 **ARIA 38600 - February 16th, 2009 - UNITED STATES - BOARDMAN**

 *10.31 - Transformation and preservation of potatoes*

 A subcontracted welder was patching a 3 cm x 1.3 cm crack found at the base of a clarifier for potato washing water within a food processing plant. An explosion occurred and led to collapse of the internal structure, killing the employee working inside. The federal agency dealing with chemical accidents (CSB) initiated an investigation. It turns out that approx. 35 cm of wastewater had accumulated in the space underneath the tank skirt and bacterial degradation had caused combustible gas to form. The investigation also revealed that gas detection had been performed, but only at the tank entrance and not at the level of the crack to be patched. In addition, the personnel had not been appropriately trained in the use of detectors, and no hot work permit had ever been granted.

 **ARIA 39076 - September 15th, 2010 - FINLAND - OULU**

 *20.59 - Manufacturing of other chemical products n.c.e. (not classified elsewhere)*

 In a pine and terebenthine oil refinery, a violent explosion occurred around 8:30 am during welding operations on a 150-m³ tank of terebenthine filled with water. A subcontracted employee was killed on the spot and 3 others injured : one was seriously hurt and required hospitalisation. Several ambulances were dispatched to the site.

 Outside of the tank directly implicated in this accident, no other damage was observed; the refinery resumed activity on the same day. This storage tank was being washed and repaired to be placed back into service. The initial elements of the investigation indicated that a welding spark was the cause of the explosion. Local police conducted their own investigation for involuntary manslaughter and injury.



Lightning : Direct and indirect effects



Explosion on a low-pressure chlorine system

ARIA 40197- 23/07/2009 - Allemagne - Ibbenbüren

20.14 - Production of other basic organic chemicals

 A lightning strike caused a voltage drop on the power supply of a chlorine-alkali plant using the mercury process. The emergency electrical system was activated, though restoring the external supply voltage in less than 200 ms rendered the entire system inconsistent; some units were operating normally, but all units connected to the emergency devices (including the mercury pump) remained idle. An explosive mix of 500 kg of chlorine and an unknown amount of hydrogen accumulated inside the low-pressure chlorine treatment circuit and, upon exploding, injured two employees and destroyed the whole circuit (damage: 237 000 euros). This accident demonstrates the need to surpass a simple binary approach (i.e. on/off) in order to incorporate short-duration voltage drops (electrical disturbances) into the safety reports. An installation's emergency power supply must be designed by integrating a SIL 2 safety integrity level (according to the Standards IEC 61508 / 61511). The site operator extended personnel training modules to include the facility's operating details, in a step to better cope with unidentified defects.

Lightning : Direct and indirect effects

Lightning is a natural phenomenon involving a disruptive electrostatic discharge following static electricity build-up between storm clouds or cumulonimbus and the earth. The difference in electrical potential between the two points, which is capable of reaching 100 million volts, produces a plasma at the time of the discharge along with a heat release and explosive expansion of the air. Upon dissipation, the plasma creates a lightning bolt and thunder.

This violent phenomenon may be at the origin of many accidents. The high-frequency atmospheric electrical discharge is capable of causing severe physiological effects on humans (death, burns, blindness, electrification specifically due to step voltage, ARIA 36096), as well as many other induced effects: breakdown of electrical equipment resulting from significant potential differences, ignition of materials due to the Joule effect, electromagnetic and electrodynamic effects, and acoustic phenomena caused by the pressure surge.

The "**direct effects**" arising during a lightning strike on structures are able to: penetrate, or even rupture, metal envelopes such as pipelines (ARIA 5678) or tanks (ARIA 18325, 25617) ; spark a fire like that on floating roof tanks in joint zones where flammable vapours accumulate (ARIA 6277, 12229, 12231, 20819). The shell/roof equipotential bonding might actually prove inadequate in ensuring safe current flow while avoiding equipment breakdown.

"**Indirect effects**" can lead to a voltage surge that propagates by means of either conduction or radiation once a lightning impact has occurred at a relatively distant point from a building or installation (ARIA 11262, 32624, 37499, 40197).

Of the 130 accidents due to lightning recorded in France within the ARIA database, 60% resulted from direct effects, 30% related to indirect effects and the remaining 10% could not be classified due to a lack of sufficient information (ARIA 33544). Fire is the most commonly observed type, with 65% of cases involving industrial facilities to the same extent as farm buildings or barns (ARIA 3707, 6277, 7168, 7664, 8885, 12937, 15215, 15849). Explosions have also been cited (ARIA 18325, 40197).

While lightning serves as the initiating external trigger of the recorded incidents and accidents, their deep-rooted causes are often associated with electrical problems, design flaws, operating mishaps or site management issues.

Many accident sources lie in electrical defects (ARIA 37499, 38617) subsequent to a lightning impact :

- ⤴ rupture of a 225-kV electrical cable (ARIA 19539) ;
- ⤴ formation of an electric arc, with ignition of a flammable gas (ARIA 5675) ;
- ⤴ electrical voltage surge (ARIA 20844) ;
- ⤴ poorly-protected electrical devices or circuits (ARIA 1200, 2715, 26577, 32016...) ;
- ⤴ loss of electrical power supply (ARIA 1884, 5874, 40197).

Whether partial or total, the loss of electrical power supply can affect all equipment and related instruments, thereby leading to deficiencies in alarms, sensors (ARIA 26577), ancillary equipment (ARIA 4507) or, more generally, any servo control system, while at the same time causing accidental discharges and spills.

Design flaws, operating mishaps and site management problems have been related to :

- ⤴ an undetected or insufficiently evaluated lightning risk (ARIA 3707, 27506, 33544) ;
- ⤴ poor management of unexpected shutdowns (ARIA 15749) or unit restarts (ARIA 26503, 26579) during thunderstorm events, without an appropriate verification of the equipment and instrumentation potentially damaged ;
- ⤴ electronic information transmission systems rendered inoperable (ARIA 32016).

Various prevention and protection measures are typically employed to mitigate the effects of lightning by means of :

- ⤴ routing the electrical flow towards a lower-risk zone ;
- ⤴ ensuring sufficient electrical conduction to the ground in order to avoid equipment overheating or destruction (equipotentiality, adequately-sized metal sections, proper and regularly-tested grounding, etc.) ;
- ⤴ paying close attention to equipment seals so as to avoid leaking flammable or combustible materials ;
- ⤴ protecting electrical and electronic equipment, particularly when such equipment is part of the safety system.

With respect to electrical supply deficiencies or disturbances caused by lightning, besides checking for weather alerts, several prevention measures may be suitable for implementation, namely :

- ⤴ switch to regularly-inspected electric generating sets (ARIA 30199 / generating set malfunction due to poor controls) ;
- ⤴ switching of power supply onto a protected line (backup power supply line, inverter, electric generating set);
- ⤴ unit shutdown or reset in safe operating mode ;
- ⤴ temporary interruption of any operations presenting a special risk ;
- ⤴ protection of sensitive or risk-prone equipment in the event of a lightning impact (ARIA 6277) ;
- ⤴ redundancy of systems and all electrical circuits vital to maintaining site safety (above/belowground electrical line).

As a violent natural phenomenon with potentially serious consequences, lightning deserves special attention from industrial site operators. Maintaining a "steady" power supply to units is key for the means of production and constitutes an essential strategic component in installation safety. The frequency of electrical installation damage, coupled with such potentially serious impacts, requires efficient management of both technical and organisational measures in order to ensure installation integrity.

Additional references (detailed data sheets, summaries) :

- ⤴ ARIA 18325: Explosion of an alcohol tank within a sugar refinery / distillery
- ⤴ Industrial accident statistics related to lightning on www.aria.developpement-durable.gouv.fr - July 2008
- ⤴ How industry copes with the risks caused by lightning - *Face au Risque*, Issue no. 451 - March 2009

Accidents whose ARIA number has not been underlined are reported on the Website :

www.aria.developpement-durable.gouv.fr

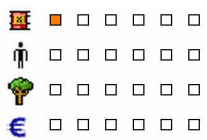
 **ARIA 5678 - 28/07/1994 - 76 - CIDEVILLE**

49.50 – Pipeline transport

A 1.20 m deep underground gas pipeline was punctured by lightning and ignited in the open field, at 200 m from residential dwellings. Flames 10 m high could be observed, cornfields burned over a 30-m radius. The impact occurred at the level of a 1.50 m wooden post planted into the soil (0.5 m) and used as a landmark for the structure ; it created 2 craters 110 mm apart. On one of them, the pipe lining disappeared altogether and the pipe wall was perforated, while on the other, the lining was locally absent and 2 perforations could be observed. The accident was noticed by a train conductor (in witnessing a brushfire), who promptly sounded the alert. After 70 min, the gas leak was detected and the site operator notified. The next step consisted of depressurising the pipe segment and flaring the gas, following modification of the zone's supply configuration. The fire was extinguished 7 hours following detection. The damaged zone was replaced (through installation of a jointing band). The supply network was re-established 7 hours later.

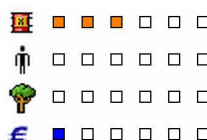
 **ARIA 6277 - 05/11/1994 - 13 - BERRE-L'ETANG**

19.20 - Oil/petroleum refining

The floating roof of a 15,000-m³ storage tank containing platformate (a close derivative of gasoline) collapses for an undetermined reason. The sinking was detected on 05/11 at 9:40 pm. Despite spreading foam for fire prevention purposes, lightning caused the inflammation of the platformate product on 07/11 around 9:45 pm during a violent thunderstorm, once the foam layer had been diluted due to heavy rainfall. The fire was contained in 40 min via the facility's internal response measures. The volume of hydrocarbons destroyed during the fire was estimated at 400 m³, 25,000 l of emulsifiers were lost. Property damage was appraised at 2.2 MF.

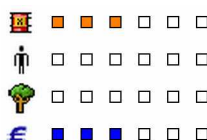
 **ARIA 18325 - 24/07/2000 - 10 - ARCIS-SUR-AUBE**

10.81 - Sugar production

In a distillery, a 5,000 m³ tank containing 1,000 m³ of ethanol at 96% concentration exploded when lightning struck and then ignited. The raised roof fell into the reservoir, which remained intact. However, the tank foot valve cracked upon impact. An emulsifier delivered 2 hours later enabled preventing the fire from spreading to the 1,000 m² retention basin. The blaze was extinguished in 3 hours and the fire-fighters for over 5 hours cooled 3 adjacent 2,500 m³-tanks exposed to the intense heat. Their structural condition would be controlled prior to resuming facility operations. During the emergency response, 23,000 l of emulsifiers stored onsite and a total of 7,000 m³ of water (including cooling water) were used. An Internal Response Plan drill conducted 2 months earlier and based on a comparable scenario involving one of these tanks served to facilitate the actual intervention. The loss was valued at 30 MF (including 2.5 MF of alcohol destroyed and 3 MF of emulsifier). The extinction water (1,500 m³) collected in the retention basins would be diluted in a lagoon. An outside organisation was called to verify the electrical installations of the storage zone. Both the flame arrestors on the vents and the breathing valves on the tanks, which had been recommended 18 months prior at the time of a lightning risk evaluation study, had not been installed. The operator was issued a formal warning to install these devices within one month. Groundwater quality was monitored on a daily basis for 7 days, then weekly for another 3 weeks: no groundwater impact was to be found.

ARIA 25617 - 22/09/2003 - 30 - SAINT-GILLES

20.14 - Production of other basic organic chemicals

Within an ethylic alcohol (fermentation) production unit, lightning struck onto a 1,000-m³ alcohol storage tank that was nearly empty ; the tank was ripped apart and ignited. Fire-fighters and unit personnel were able to contain the outbreak. The alcohol and extinction foam were confined to the retention basin. A surveillance operation remained in effect in order to avoid any repeat ignition of the alcohol. Once the surveillance had been completed, the emergency response centre retracted the Prevention Plan (PPI).

ARIA 33544 - 05/07/2006 - 81 - MAZAMET

13.99 - Production of other textiles ("not classified elsewhere")

In a plant producing felt textiles for the automobile industry, a fire broke out at the level of the transformer room, which contains a 630 kVA transformation unit. The origin of the fire is correlated with the direct or indirect action of lightning on the site or in the vicinity. The fire was fanned by the combustion of oil residues contained in the regulatory retention tank (i.e. a volume of less than 1 litre). Control of the dielectric quantity (without PCB) contained in the transformer compartment, undertaken by the subcontractor, indicates that this quantity matches the filling level. An examination of the transformer does not reveal any blisters present in the case of a direct lightning strike; furthermore, the absence of a leak on this transformer offers proof that the integrity of this unit has been preserved. The presence of smoke on the wall and traces in back of the transformer demonstrate that fire had occurred in the tank. This onset of fire could thus be explained by the creation of an electric arc at the level of the tank and the ignition of oil deposits (i.e. a potentially fouled tank). The plant's lightning study underscores that the transformer must be protected by lightning rods, which are indeed very present on the site's supply post, as per the study's set of recommendations. Their state of repair shows no underlying destruction. This study however must be updated every 5 years, and the last study dates back to 7/04/98. The operator is thus requested to update this study. On the technical side, the lightning study recommends introducing other measurements on the following installations: interconnect the incinerator chimney and structures, remove the former dust cleaning installation, interconnect the dust recovery system with structural masses and the external lampposts with the electrical ground network of the building, equip the protective control and power circuits with a lightning arrester as well as the automatic sprinkler circuits, the suction and the hot air duct, the cooling electrical cabinet, the telephone lines and the secondary power transformer. This study also recommends installing temperature probes on both the cooling fan and charcoal filter box.

 □ □ □ □ □ □ **ARIA 32016 - 24/07/2006 - 80 - AMIENS**

 □ □ □ □ □ □ *37.00 - Wastewater collection and treatment*

 □ □ □ □ □ □ A discharge of black wastewater polluted the SELLE River and caused fatalities among the fish population. An alert was sounded during the morning of the following day. The pollution occurred subsequent to the deficiency of a pumping station at the city's purification plant, leading to the direct spill of wastewater (discharged from a dry cleaners) into the natural environment via the overflow chamber.

 □ □ □ □ □ □ The general station circuit-breaker, turned off at the time, was responsible for the accident. Once it had been turned back, normal operations could be restored. This malfunction would have been due either to vandalism (signs of forced entry into the electrical cabinet) or to the intense heat. Moreover, network remote monitoring was running in a degraded mode : a thunderstorm a few days prior had destroyed the remote transmission equipment at the pumping station, with information on system flaws not being relayed to the monitoring station. These safety devices could not be replaced due to an inventory shortage in the maintenance workshop, and many equipment replacements had to be carried out since the beginning of the month due to the frequent occurrence of thunderstorms.

 □ □ □ □ □ □ **ARIA 36096 - 16/04/2009 - 73 - CHIGNIN**

 □ □ □ □ □ □ *46.71 - Wholesale of combustibles and ancillary products*

 □ □ □ □ □ □ During inspection rounds inside a petroleum depot during stormy weather conditions, an employee received an electrical discharge. A medical exam revealed a mark on the right hand, accompanied by chest pains and numbness in the right arm.

 □ □ □ □ □ □ Several hypotheses were forwarded to explain the symptoms: lightning, electrical short in the depot, faintness due to cardiac troubles.

The immediate measures adopted were : restricted access to the incident zone for the remainder of the night, disconnection of all electrical outlets located near where the short circuits occurred, and remote monitoring by the site security company. On the next day, the fire automation systems on the manifold were tested under remote control conditions and revealed no anomaly. An indirect electric shock due to a recent thunderstorm event was considered the most credible hypothesis, as confirmed by recordings of lightning impacts less than 4 km away at the time of this injury, in addition to the recording that a neighbouring installation had to switch onto a backup electrical system. This shock may have been facilitated by the umbrella and may have multiple sources: transmission of electrical potential by the adjacent railroad track, or the "electrification" of ambient air. After this incident, the site operator took a number of measures, including the restriction of vehicle traffic in the event of a thunderstorm, applicable to all those present onsite (depot personnel, subcontractor employees, visitors). The warning of upcoming electrical storms would be sounded by the lightning detector alarm and then corroborated by visual inspection. The use of umbrellas onsite would also be prohibited.

ARIA 37499 - 07/11/2009 - 76 - GONFREVILLE-L'ORCHER

20.15 - Manufacturing of nitrogenous products and fertilisers

Around 1:40 pm, lightning struck 4 lightning rods within a Seveso-rated chemical plant, causing an electricity outage. Some of the ammonia (NH₃) storage sensors were damaged, and this in turn triggered the corresponding installation safety sequences. The storage equipment fire detection post also sustained damage. The urea and NH₃ production facilities were not included in these sequences due to the presence of an alternator, which supplied all the necessary electrical power.

While waiting to reset the various detection devices that had been activated, the operator adopted several measures: bringing back online the storage zone by shunting the damaged detectors, with the permanent presence of a technician in the NH₃ storage control room; inspecting once per station those electrical utility rooms whose fire detection was no longer operational; prohibiting the loading of railcars, trucks (NH₃, alkali) and boats; and shutting down the alkali production line.

The 4 impacts recorded on 4 different lightning rods at the site may be explained by a branching of the arc-back (lightning surge). Another explanation (which would still need to be confirmed however) is that the arc-back only struck a single lightning rod or any other installation and then while spreading through the soil, the lightning current caused a high enough rise in ground potentials to produce current spikes via earth electrodes within the lightning protection installations. Such a phenomenon could have incremented the 4 lightning strike counters.

The classified facilities inspectorate noted that the preliminary lightning assessment was inadequate and requested that the site operator conduct a new study as quickly as possible. Moreover, the operator was required to assemble a spare parts inventory for all site safety equipment.

 ■ □ □ □ □ □ □ **ARIA 38617 - 14/07/2010 - 62 - WINGLES**

20.16 - Manufacturing of basic plastic materials

 □ □ □ □ □ □ During a thunderstorm, an electrical outage at 10:46 pm interfered with polystyrene (PS) production at a Seveso-rated plant with 27 of the 160 employees present onsite. A safety disc broke and styrene was released.

 □ □ □ □ □ □ The "CMP" workshop was continuously producing 2 types of PS: "crystal" (DC1 and DC2 lines), and "shock" (DC3 line). The "EPS" shop was producing in batch mode "expandable" PS in 6 non-synchronised reactors: 2 at the beginning of the cycle, 2 at the intermediate stage, and 2 at the end of the reaction.

 □ □ □ □ □ □ In order to minimise the impacts of micro-outages (due to electrical storms) on the quality of PS produced, the plant operator typically switched the shop power supply onto the 4 electric generating sets of the site's "EJP" power unit. This switch took place at 10:20 pm, with 3 of the generating sets being available at the time. At 10:43 pm, the storm knocked out the first set; since the 2 other sets proved insufficient, the "EJP" power unit tripped into safe mode at 10:46 with a loss of utility services. A technician attempted to restart the EJP unit ; a bit later, at 10:53, the on-call maintenance electrician, who was the only person actually certified to switch the power supply back onto the EDF grid, was called. The internal alarm was sounded at 11:01 pm, which in turn activated a crisis management unit and notified both an on-call team and external first responders.

At 11:05, pressure in the first DC1 reactor began to rise. In accordance with the plant's emergency procedure, gyro monitors were turned on at 11:15 so as to contain vapours that may have been vented from reactor 1 / DC2 line. Given the process employed and in contrast with what was happening on the other 2 lines, a pressure surge might have ruptured the disc. The site was connected to the grid network at 11:18 pm, though the units started up following a short time lapse. At 11:20, the disc of reactor 1 (DC2) burst at 5.8 bar, splattering a liquid mix containing 10 tonnes of PS and 3 tonnes of styrene.

At 11:40, a peripheral water curtain was activated to control the vapours. Both reactors from the EPS workshop at the beginning of the polymerisation process were emptied into an emergency pit as a precautionary measure. At 12:25 am, styrene concentrations around the pit and in 4 neighbouring municipalities had returned to zero. The state of alert was lifted at 2 am. The efficiency of these gyro monitors, along with the degree of polymerisation (smaller quantity of styrene) and the confinement of aqueous discharges within a basin, all helped limit the consequences to operating losses; neighbouring residents were nonetheless inconvenienced by foul odours. An emergency order was issued and the units allowed to restart on 19 July. The reactor's runaway response was due to the loss of utility services. Since the technician had not completed the manoeuvre to contain the pressure surge, the emergency vent on the CMP unit's line 2 reactors had not opened early on during the incident, as indicated in the procedure. During a thunderstorm, electrical power is provided by the EDF company incorporating positive safety features, which remain independent of available utility services or of inverter backup on key safety equipment, as needed to control a runaway reactor. The emergency procedure adopted for the DC2 line was modified: open vent valve, and start-up of gyro monitors upon initiation of the emergency shutdown procedure. The cooling of this line was also modified in order to limit disc ruptures during runaway reactions.



Striking a balance between prevention, mitigation and intervention

Break in an underground storage pipeline

ARIA 38242 - 01/05/2010 - 04 - Manosque

52.10 - Warehousing and storage

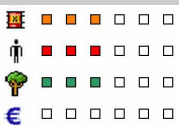

Around 7:20 pm, at the time of injecting naphtha originating from a refinery, a steel pipeline (DN 500-62 bar: 7 mm thick) burst open at a site dedicated to underground hydrocarbon storage using saline cavities in the heart of the Luberon Natural Park. A deafening sound combined with a sudden drop in pressure caught the attention of employees. Some 400 m³ of naphtha flowed through the opening towards a 5,000-m³ capacity retention basin located several hundred metres downstream; from this basin, a total of 200 m³ of product spilled out via 2 sluice gates that had remained open and that would only be closed 27 minutes

later.

The internal emergency plan was activated around 7:30 pm. Site personnel were evacuated, and the attendant fell ill and had to be hospitalised.

Faced with the risk of igniting a flammable cloud that had formed along the naphtha path, the local prefecture convened the emergency response unit and initiated the external emergency plan at 10 pm; 75 fire-fighters, a chemical emergency squad, another specialised pollution cleanup team and some 20 gendarme were all deployed. A 1,000-metre safety perimeter was implemented, traffic in the vicinity was closed on two thoroughfares, and 282 residents from two localities were evacuated. Rescue workers spread a foam blanket over the surface of the liquid contained in the retention basin and installed water curtains to dissipate the cloud. Two fire-fighters feel unwell and placed under oxygen assistance.

Four containment booms were installed on the AUSSELET and LARGUE streams, both of which were heavily impacted over a 5-km length. By 4 am the following morning, the majority of residents had returned to their homes, though water pumping was suspended in three nearby municipalities.

A specialised subcontractor pumped 150 m³ of the naphtha. Once the cloud had been dispersed, the external emergency plan was lifted at 6 pm the same day, and the last few evacuees were allowed to return home.

The land area surrounding the defective pipeline buried 2 m deep was excavated; a 3-m long opening was identified on the lower generatrix between 2 girth welds. The facility connecting the pumping station with the storage well, retested and certified in 2003 at 73 bar, was equipped with cathodic protection.

Impacts on flora and fauna were observed in pristine and protected natural sites (death of mammals, amphibians and invertebrates); an assessment was subsequently conducted (fauna, flora, water, sediments, soil/subsoil, ecotoxicity and genotoxicity), accompanied by enhanced monitoring of both surface water and groundwater resources.

An appraisal of the defective pipe segment revealed a "cavernous" type of corrosion (i.e. by differential aeration) that had become widespread over a 50-mm strip, with a loss of thickness (1 mm on average and in excess of 3.5 mm locally).

The operator devised an initial series of remedial measures to treat the recorded malfunctions, involving: remote automation of the sluice gates slaved to pressure drop detectors, with relays to the control room and hydrocarbon detector servo systems; modification of pipe section shutoff equipment in the event of a leak; additional hydrocarbon detectors; inspection of sluice gate condition and seals.

Striking a balance between prevention, mitigation and intervention

The focus of actors is naturally drawn to identifying and mitigating potential hazards, as well as to technical and organisational measures aimed at reducing accident probability. Regardless of the efficiency of such measures, the risk management strategy cannot be confined to the previous approach only, and overlook residual risks and their undeniable eventual consequences.

Furthermore, accident records have already shown that actors can sustain major setbacks and be relatively unprepared should the methods adopted to cope with residual risks, given the nature of exposed vulnerabilities, not be properly vetted in advance with sufficient knowledge of the potential and limitations of all resources available.

The low probability of the most feared event, coupled with approved prevention efforts, are not justifiable grounds for neglecting a strategy for such events. Several accidents have occurred more or less recently in France and abroad indicating shortcomings in this area. In the Hungarian city of Ajka (ARIA 39047), with no emergency plan, the operator of an aluminium plant was faced with a 700,000-m³ spill of mining effluent following the failure of a basin levee. In Toulouse (ARIA 21329), planned protection measures proved inappropriate since the scenario of an ammonium nitrate detonation had not been addressed. In Nantes (ARIA 5009), a strategy for extinguishing a fertiliser depot was only developed several hours after the incident had been detected; in the meantime, confinement steps followed by the evacuation of tens of thousands of residents were approved and carried out.

A lack of knowledge of both the effects and their eventual consequences can complicate the work of fire-fighters and compromise the safety of rescuers and third parties. In Salindres (ARIA 5993), inside a packaging plant for agro-pharmaceutical products, no members of the management team had any knowledge of the risks associated with a facility recently placed into service. In Rosteig (ARIA 168), the monitoring and intervention plan for an oil pipeline had not addressed scenarios like a massive leak of liquids or the presence of an explosive cloud. In Saint Romain-en-Jarez (ARIA 25669), an orchard farmer, who likely was unaware of the hazards inherent in ammonium nitrate use, only informed emergency responders of the presence of 3 to 5 tonnes of fertiliser with this ingredient 4 hours after the farm's storage hangar caught on fire; during this lapse of time, an explosion injured 18 fire-fighters, who apparently had not received the safety guidelines for dealing with this type of fertiliser. Similarly, the level of environmental awareness of exposed vulnerabilities (Natura 2000, Natural Park) must be known and taken into consideration when adapting measures to fit a given situation (ARIA 36654, 38242).

Early detection of the most feared event is a critical step to limiting its potential magnitude. For example, a fuel oil leak on a refinery pipeline detected 5 hours after the fact caused the spill of 478 tonnes of hydrocarbon, 180 tonnes of which emptied into the Loire River Estuary (ARIA 34351); 90 km of riverbanks had to be cleaned over a 3-month period. At a chemical plant not equipped with detection devices, 2.4 tonnes of ammonia were released into the atmosphere 1 hour and 40 minutes before employees became aware of the incident (ARIA 733). In an underground facility used to store supposedly non-combustible waste, which accounts for the galleries being devoid of fire detection devices, 3 hours were needed to locate a fire source; hotspots remained for 2 full months (ARIA 23030). The lack of confinement basins for fire extinction water and retention basins for hazardous overflows or their less than 100% efficiency can exert significant influence on both aquatic and terrestrial flora and fauna (ARIA 38242), in addition to adversely affecting the drinking water supply for local populations (ARIA 161).

Intervention resources available for implementation must be well defined, "easily" deployed and clearly listed in all emergency plans. At an oil depot, following the explosion of an unleaded gasoline cloud, an event that went unaddressed in the site's hazard study, the gathering of the mitigation devices (foam compound, pumping equipment) required to put the fire out took over 6 hours, by which time the area engulfed in flames had extended 6,560 m² (ARIA 2914). These intervention plans must take into account all possible accidents and undergo periodic updates and testing to ensure verification of plan relevance and effectiveness. As an illustration, trained personnel working in a power plant where drills had been conducted on a regular basis were able to bring a fire on a diesel generating set under control within 20 minutes of ignition (ARIA 33899).







During the event handling sequence, information of various actors (particularly public rescue teams) is necessary to ensure responder protection as well as adequacy of the set of measures adopted to assist or protect local populations. When a fire was burning inside a refinery's HDS unit (ARIA 27459) and in the lack of information distributed by the operator, the police temporarily halted traffic on a motorway. In Belgium (ARIA 35905), an H₂S cloud caused a nuisance to several hundreds of peoples, who fell victim to nausea and breathing problems, with 57 among them requiring medical attention; no alarm was sounded due to a lack of sufficient information circulating onsite and no communication between local responders and authorities in the neighbouring country; up to 100,000 people were potentially exposed.







As a prerequisite to posting communication during an accident, it is critical to inform the public in order that population likely to be exposed can learn first hand of the type and magnitude of risks, as well as the protection measures taken, in an effort to avoid inappropriate behaviour to the greatest extent possible.







Accident records regularly and relentlessly recall the limitations of preventive measures and debunk the myth of "zero risk". While unable to eliminate all risks of major accidents arising relative to hazardous materials and processes, it is still essential to strike a reasonable balance between prevention, mitigation and intervention. Civil society would find it incomprehensible that such processes can be implemented without planning the appropriate measures to enact in the case, even highly unlikely, where an accident might occur.







Accidents whose ARIA number has not been underlined are described on the Website :

www.aria.developpement-durable.gouv.fr

      **ARIA 161 – 08/06/1988 - 37 - AUZOUER-EN-TOURAIN**
20.14 - Manufacture of other basic organic chemicals
 An explosion and a fire occurred during the night in a chemical plant during the manufacture of a silicon oil- and additive-based waterproofing agent.
 A junior technician (hired 6 months back), recently assigned to this post, was left without supervision around 1.00 am to manage a process modified in June and implemented for the second time. Since the order of addition of reactants was not specified in the operating procedure, he loaded 800 kg of oil into the tank 1702 on level 1, started heating the reactor, went back to level 0 to pump the reagent. While going up to level 2 to fill a tank with water, he observed a kind of fog escaping from the tank 1702. The explosion that occurred around 3.00 am resulted in the formation of hydrogen generated by the decomposition of the silicon oil after the abrupt and uncontrolled addition of an extremely basic alcoholate. The fire that ensued consumed 500 tonnes of chemicals (mainly alcohols), spread to significant part of the site (7,000 m²) and resulted in a huge cloud of smoke.
 The technician was thrown 10m away, suffered a concussion and sustained serious burns and injuries. During the rescue operations, 2 fire-fighters were injured and 15 other poisoned. Despite the difficulties encountered, the rescue workers brought the situation under control in 4 hours. Analysis of the air revealed low levels of CO and NO_x. The absence of retention devices, unused pipes and malfunctioning of the internal waste water treatment plant led to the disposal of the fire water (cyanide compounds, pentachlorophenols, etc.) in the Brenne river, a tributary of the Cisse river. Both the Cisse and Brenne rivers were polluted over 23 and 5 km respectively wiping out all traces of plant and animal life: 20 tonnes of fishes, aquatic and terrestrial mammals were destroyed. A high phenol index was measured in the Loire river: catchments were shutdown on 9/06 depriving 200,000 inhabitants of Tours and the adjoining area of drinking water. The water supply was restored in 3 days with a ban however on human consumption for 8 days. Drinking water supply was arranged for 10 days. Material damage and operating losses of the company stood at 45 MF and 8 MF respectively.
 The chairman of the company was given a 1-year suspended sentence and fined 120,000 F while the plant manager received a 6-month suspended sentence and was fined 60,000 F. The damages to be paid to the civil party stood at 800,000 F. The accident resulted from a major organisational failure (absence of safety policy, incomplete procedures, etc.).

      **ARIA 168 – 28/07/1989 - 67 - ROSTEIG**
49.50 - Pipeline transport
 While conducting earthworks, a loader punctured an oil pipeline (Ø = 400 mm), buried 1.2 m deep and carrying naphtha at a pressure of 8-10 bar. Emanating from a 30 cm² opening, a jet spray 5 to 10 m high created a yellowish smelly aerosol that was spread by gravity over several hectares, encompassing an entire football field and a recreation centre.
 The subsequent explosion shattered window panes and blasted tiles from roofs on nearby dwellings. The wood panelling on a building was burned. Gendarme officers had previously overseen the evacuation of children playing on the sports pitch, which along with several hectares of fields also burned. In all, some 100 residents had to be evacuated. The pipeline opening was clogged 2 days later. The death toll due to burns stood at 2 gendarmes and 1 civilian.
 The administrative department responsible for pipeline monitoring held a number of technical meetings to analyse the consequences of this accident on the oil transport facility and laid out a pipeline repair programme. Renovation works took place from April 14th to 19th, 1989. Following a satisfactory radiographic inspection of the welds, the pipe lining was successfully repaired on August 18th and 19th.
 Being updated at the time of the accident, the monitoring and intervention plan had not foreseen the scenario of a massive leak of liquid product combined with the formation of an explosive cloud and therefore did not provide a suitable intervention protocol. The administrative team responsible for monitoring undertook, in collaboration with the pipeline operator, the design of a new plan in compliance with regulatory prescriptions.

      **ARIA 733 – 21/02/1989 - 59 - LA MADELEINE**
20.14 - Manufacturing of other basic organic chemical products
 During a transfer operation involving a cistern located in the acid production plant and nitrated by-products from a chemical plant, a rupture disc broke around 6:45 am on a line connecting a cryogenic ammonia (NH₃) storage facility containing a 340-tonne theoretical capacity (-33°C at 1,013 mb, 310 payable tonnes) with a gas holder. Within a span of 105 min, between the presumed onset of the leak and its discovery by site personnel, 2.4 tonnes of NH₃ were released into the atmosphere. A passer-by notified the fire department 25 minutes later.
 A toxic cloud wafted over 4 km at an average speed of 0.3 m/s. 20 min and 3 attempts were required by the team of technicians, alerted around 7:15 am, when arriving on duty to close the chain valve that isolates the ruptured disc. The first attempt failed when the chain slipped and the pulley got stuck. Bothered by the NH₃ gas entering his protective gear worn for the occasion but not properly adjusted, the technician decided to abandon the second attempt. This older-generation storage facility was not equipped with any internal pressure measurement recording system. The neighbouring population was asked to remain indoors and no injuries were reported, aside from odour nuisances and ocular discomfort from time to time until 9:30 am.
 Several installation malfunctions downstream of the release preceded the accident. The operator drew a number of lessons, namely: a degraded operating regime not fully acknowledged by the technician when the cistern was being prepared for transfer; inadequate maintenance and control of both the measurement instruments (poorly calibrated flow meter) and protection systems (poorly installed rupture disc, a safety valve difficult to manipulate, etc.); design flaws (manual pressure setting, lack of visibility between the transfer station and the tank being filled); absence of leak detection device (notification relayed by neighbours); use constraints specific to the protective gear (choice of equipment, user instructions, practice); sharing of recommendations and information between line staff; intervention protocol (installation safeguards, isolation of storage compartments, etc.); staff training (under normal or degraded conditions, relevance to intervention techniques).
 This accident, which generated a strong psychological impact, received heavy media coverage. Both the installation and operating guidelines were revised: installation of 2 pressure sensors, one connected to an alarm the other to a recorder; a relief valve on the tank; an NH₃ detector alarm; an automatic transfer shutoff device; and the scheduling of frequent inspection rounds at the time of transfer operations.

      **ARIA 2914 – 07/10/1991 - 44 - SAINT-HERBLAIN**
46.71 – Wholesale of fuel and related products
 A leak occurred at the level of a fitting on a 12" racking pipe located downstream of the foot valve on a 4,525 m³ tank containing unleaded gasoline with a 98 octane rating (SP98). The retention basin of this tank also served as the basin for a 4,500-m³ tank of domestic fuel. The accident took place during remote-controlled valve opening: an aerosol formed, then spilled over the top of the basin wall (H = 2 m) and flowed by gravity onto the parking lot. After about 20 min, the cloud of some 25,000 m³ in volume ignited. The vapour cloud







explosion (VCE) fatally injured a driver, seriously hurt 2 employees and caused slight injuries to 3 other drivers. The POI response plan was activated. The fire spread to two compartments of the retention basin, to 2 tanks and to the tanker trucks parked on the lot, in addition to threatening storage areas. The 200 firefighters called to the site cooled a 1.5-m³ LPG cistern located 30 m from the basin and proceeded to protect two 15,000-m³ tanks of leaded gasoline and fuel oil (using a water curtain). It would take a long time to gather the necessary firefighting resources: 80,600 litres of emulsifier were assembled (17,000 litres borrowed from neighbouring industries), a tugboat equipped with a 12,000 l/min pumping station provided sufficient pumping capacity (an 8-m high tidal range on the LOIRE prevented the pumps from operating properly). The ensuing fire, propagating over a 6,560 m² area, was extinguished in 72 min.







The explosion caused serious damage to structures as far away as 100 m and broken windows up to a distance of 1 km; it was exacerbated by ignition of the aerosol within an enclosed room at the washing station, which had the effect of both raising the inflammation energy (with the lorries parked at an angle helping accelerate the path of the flame) and increasing the pressure surge generated by the deflagration. The site's wastewater network was overcome by hydrocarbons and became the site of subsequent explosions. Total material damage was estimated at 16 million euros: 2 tanks, 4 vehicles, 15 tanker trucks and their washing station were all destroyed; 3 other reservoirs and facility offices incurred damage, and system pipes were deformed. Approximately 500 m³ of hydrocarbons polluted the ground over a 2-ha surface area to a depth of 7 m and seeped into the groundwater.

A pressurised gasoline leak at the level of a rubber seal for a pipe fitting would have been the cause of the accident; moreover, the lack of wind served to limit dissipation of the vapour cloud that formed. A prefectural order was issued on October 30, 1991 suspending operations, with resumption of site activity requiring completion of a full authorisation request submission. The fuel depot was reopened for business at the end of 1993.

 **ARIA 5009 – 29/10/1987 - 44 - NANTES**

46.75 - Wholesale of chemical products

      At a warehouse storing unknown contents, the self-sustaining decomposition of a stockpile of 850 tonnes of fertiliser NPK 15-8-22 delivered five days earlier caused the formation of a cloud 10 km long heading westward; in this cloud, the presence of nitric acid and chlorine were detected.

      The ORSEC plan for dealing with crises was activated; 200 fire-fighters, 627 police officers, 489 gendarme officers, 356 soldiers, 200 emergency responders and over 1,000 municipal employees were mobilised. An extensive evacuation plan spanning 7 municipalities located downwind of the warehouse was implemented. The incident was eventually controlled after 7 hours of emergency intervention.





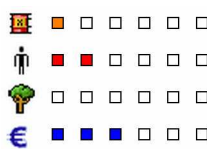

The human toll amounted to 3 intoxicated employees, one of whom was placed in 24-hour observation at the hospital. Even though the overall evacuation measure applied to a population of 70,000, the actual number of individuals moved for a period of 9 hours during the crisis was evaluated at 38,000. The LOIRE River was only minimally polluted considering the widespread dilution of fire-fighting water.

As a result of both their transport conditions (in the hold of a ship that had previously stored wheat) and storage conditions (on a bed of sawdust), the fertilisers responsible for this accident were placed in close contact with organic matter, whose concentration at certain spots could have been quite high. Moreover, the site's obsolete electrical installation was partially to blame.

The combustion zone began at a point directly aligned with the electrical cables that were dangling underneath the aboveground system for handling stored substances; the cut ends of these cables were probably buried in the mass of fertiliser. Under these conditions, ignition was likely initiated in the depths of the fertiliser pile, immediately adjacent to both the mass contaminated by sawdust and the buried electrical conductors. The fire then spread by means of self-sustaining decomposition of the fertilisers. This accident still would not have reached such proportions had an efficient response been organised as of the initial detection of heat accumulation.

 **ARIA 5993 – 02/11/1994 - 30 - SALINDRES**





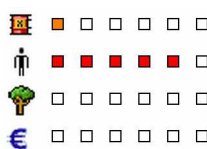

20.15 - Fabrication of nitrogen products and fertilisers

      In a factory packaging agro-pharmaceutical products, an insecticide (LANNATE) fell from a hopper on a packaging line while employees were changing the valve at the base of the machine. The building was evacuated owing to the presence of toxic dust. A slight explosion occurred slightly thereafter (electrical incident -> sparks). A fire broke out and spread to neighbouring packaging (fertilizer...) and to the

building (2 levels- 1,600 m²); 130 firemen intervened (3 were effected), 40 employees and local residents were evacuated. A neighbouring site and a childcare centre were instructed to confine themselves. The community was isolated. The firefighting water was collected in a 8,500 m³ catchpit. Certain difficulties were encountered during the intervention: the plant had been commissioned recently and the firefighting network was not yet operational, building inaccessible, fire doors closed, no executive personnel was had knowledge regarding the hazards at the site, slightly swirling wind, light rain and low ceiling, no map and products poorly known... Property damage was evaluated at 20 MF.

 **ARIA 23030 – 10/09/2002 - 68 - WITTELSHEIM**

38.22 - Hazardous waste processing and elimination

      A fire broke out at a potash mine about 4:15 am within an underground storage site devoted to toxic industrial waste (50,000 tonnes/year), which had been operating since February 1999 in galleries specifically excavated for this purpose at a depth of 535 m below the ground surface. The waste authorised for storage, identified as not flammable, explosive, gaseous, liquid, volatile, radioactive,

biologically toxic, unstable at the mine bottom temperature (35°C) or reactive with salt or water, was placed in "big bags" (capacity: 1 m³), with a double pocket or in metal containers stored in 220-litre metal barrels. The fire spread over a 1,700-m² area and involved 1,800 tonnes of household/industrial waste incineration ash and residue from asbestos removal operations; according to the site operator, it was the residue packing material (big bags, pallets) that caught fire.



Miners were first disturbed by smoke entering the rock salt galleries around 5 am, then the storage site personnel sounded the alarm about 7 am. The fire was located at 7:15 am; 4 teams of miners, all wearing self-breathing apparatuses, relayed one another at the mine bottom assisted by 25 fire-fighters at the surface. A water pipe was installed inside the gallery. Blocked air intakes helped limit spreading of the flames. A press release delivered during that afternoon suggested that the situation would soon be under control. High sulphur dioxide concentrations were measured at the manhole outlet; the population was not asked to remain indoors, yet 3 schools close by were closed out of precaution. The slow combustion of these wastes would last for several days, with hotspots persisting for another 2 months. A court case was brought against unknown persons for deliberate endangerment of others. Conformance of the waste being stored relative to operational specifications was examined, and 4 independent experts were called to verify compliance with safety rules. The impact of smoke released into the environment was also investigated.

Site activity was suspended, 27 employees at the storage facility and 350 miners were made redundant. Since such an occurrence had been deemed unimaginable, the galleries were never equipped with fire detection sensors; 3 hours were

required to locate the source of this fire. Since the storage centre was not independent of the mining activity, some of the galleries were connected to salt mining galleries. The operator revised the entire centre's safety plan. Expert analyses pointed to self-ignition of the wastes (through biological degradation, chemical decomposition, chemical reaction between isolated substances). The centre's definitive closure, announced for September 2003, led to conducting additional studies, this time focusing on: onsite waste storage safety through building confinement, partial or total waste recovery, long-term mechanical behaviour of the underground facility, environmental and health-related impacts for neighbouring residents and businesses.

    **ARIA 25669 – 02/10/2003 - 42 - SAINT-ROMAIN-EN-JAREZ**



01.24 - Cultivation of fruits with seeds and stones

   Fire-fighters battled for 45 min to contain the blaze at a 1,000-m² hangar belonging to a fruit farmer when a very powerful explosion rocked the building around 5 pm. The explosive mass involved was estimated at 300-500 kg of TNT. The building housed: between 3 and 5 tonnes of ammonium nitrate stored in big bags, 2 gas bottles, and cold storage units filled with fruit. The emergency response plan was activated.





A total of 23 injured, including 18 fire-fighters, were reported, 9 of whom in serious condition. Roofs and cars were damaged over a radius extending 800 m by shockwave and projectiles, but no significant thermal effect was observed. The fire that spread after the explosion released a large quantity of black smoke. Emergency responders experienced difficulties: no mobile phone network coverage, fire hydrants plugged or lacking pressure. This accident was contained around 8 pm; 94 residents had to be housed elsewhere, after setting up a 300 to 400-m safety perimeter, and safety measures remained in effect throughout the night. The psychological team dispatched to the site as of 3 October logged over 100 consultations. Some 60 residents had to wait 4 days before returning home. The monitoring programme was stopped by local gendarmes 11 day after the explosion. This explosion corresponded to the detonation of a portion of the 3 to 5 tonnes of ammonium nitrates present in the hangar. During the year 2003, local farmers' fertiliser inventory levels were especially high since they went unused following a frost event in April. According to experts, the melted plastic from crates likely spread and got mixed with the ammonium nitrate, which in turn melted when exposed to heat. This mix might have been a factor leading to the instability that caused the explosion. Several ignition sources could have triggered the fire: an electrical overload on the installation (modified just prior in order to transform the cold storage rooms), or fermentation of the hay in storage or a simple smouldering cigarette, all of which have been hypothesised. Yet the most credible thesis would be that a light bulb apparently left lit exploded (the switch was found in the "on" position). The abundance of combustibles in the hangar led to a fast and extensive spreading of this fire. Likely unaware of the hazards related to ammonium nitrate, the operator only notified the rescue crew of its presence at 8 pm. According to fire-fighter accounts however, no national memorandum had been circulated warning of the dangers associated with these fertilisers. Following this accident, verifications of storage conditions for ammonium nitrate-based fertilisers on farms and agricultural supply cooperatives were strengthened at the national level.

    **ARIA 27459 – 26/06/2004 - 69 - FEYZIN**



19.20 - Oil refining

   Fire broke out on the furnace of a hydrodesulphurisation (HDS) unit for refinery diesel. Flames and thick black smoke, containing CO₂ and SO₂, were visible at the smokestack. The site was locked down 5 min after detection of the accident. The internal emergency plan was not activated. Notified by neighbours, 60 fire-fighters and 15 emergency vehicles were dispatched to the site without having to respond. The fire was contained within a half hour by internal teams, once incoming loads and H₂ were shut down, as the strategy called for the fire to burn itself out: reactor decompression downstream fed the fire inside the furnace for several hours.

Out of precaution and lacking precise information from the operator, the A7 motorway was closed for an hour. City police evacuated 600 residents. During the evening, the site director issued a press release: 2 members of the in-house fire crew were slightly injured. The quantity of burnt hydrocarbon was estimated at 45 tonnes, while 1 tonne of SO₂ was released. According to atmospheric pollution records, the SO₂ concentration never exceeded the threshold required to issue a public statement. At the suggestion of the DRIRE (Regional Directorate for Industry, Research and the Environment), the Prefect ordered that any resumption of HDS unit operations be conditional upon submission of a report on: the smokestack condition, state of continued unit safety, and evacuation/elimination of all waste and effluent stemming from the fire. The furnace (T = 420°C, P = 40 bar), fitted with austenitic stainless steel tubes (diam.: 6"), contained a convection zone in the upper part (not accessible to inspection) and a radiation zone (tubes in contact with the flame, accessible and considered as the most heavily exposed) below. During the accident, the upper part underwent the greatest heat flux: in some spots, metal exposed to red heat, melted tubes, fired refractory material. An appraisal of the responsible tube (not melted) revealed a lack of thickness due to a former attack exacerbated by oxidation/sulphuration and slight creep due to the presence of coke on the walls. An analysis of operating parameters showed no evidence of a drift. The operator replaced the furnace along with other equipment, depending on the temperatures actually reached. The smokestack, shared by the HDS and atmospheric distillation (AD) units, was thoroughly inspected (for thermography and verticality), yielding no noteworthy anomaly. The furnace flue and connection were renovated (with new refractory bricks). AD unit operations, shut down during the accident, were allowed to resume. The HDS unit was down for a total of 3 months. The cost of property damage was estimated at €6 million, while operating losses amounted to €22 million.

    **ARIA 34351 – 16/03/2008 - 44 - DONGES**

19.20 - Oil refining

   While loading 31,000 m³ of bunker fuel in a ship, a leak in a refinery transfer hose resulted in a major oil spill in the Loire estuary.

 At 4.10 pm, a person on a barge observed the presence of hydrocarbons on the water surface and sounded the alert. At around 4.45 pm, a roundsman identified and isolated the leak at 500 m upstream to where the hydrocarbons were detected.





The internal contingency plan was triggered at 5.00 pm and the inspection authorities of classified facilities were informed. A recovery ship was stationed at the mouth of the river while two trawlers recovered hydrocarbon pellets from the river. The public ban on access to several beaches and fishing in the river that was in place subsequent to the spill was gradually lifted between the 4 and 18 of April. Over 750 people were involved for three and a half months in cleaning up the 90 km of polluted banks (6,170 tonnes of waste recovered and stored onsite before disposal). The operator bore the cost of 50 M euros to cover for the damage incurred, clean up and compensate effected businesses. Investigations revealed that the leak was detected only after 5 hours leading to 478 tonnes of fuel being spilled of which 180 tonnes flowed into the Loire estuary.

A 16 cm² longitudinal breach caused by corrosion localised under the insulator was observed upon examination of the hose. The corrosion resulted from a water leak in the vertical pipe. Water seeped beneath the insulator, caused corrosion and subsequently caused the fuel pipe to rupture. Despite several defects detected the previous month on the same rack, the operator failed to revise this inspection programme to take into account the specific risks presented by this line given its proximity with the river banks. The effected fuel line was completely stopped and the inspections on the entire rack revealed







several corrosion points on other lines that required repair.

The operator was required to implement several additional initiatives and measures:

- Extending inspection operations to other pipes in the site along with measurement of thickness at sensitive points (supports, spurs, etc.)
 - Moving the layout of the service water mark so that it is not in a vertical position with respect to the insulated pipe
 - Using a leak detection system along with a remote alarm in the control room to constantly monitor pipes located near the river
 - Modifying the ground below the rack to channel any accidental spill to an adapted recovery network
 - Installing a device to monitor the quantity of products leaving the tank and entering the corresponding transfer hose
- It was also planned to consolidate the available emergency measures in the event of accidental pollution of the Loire river.

     **ARIA 35905 – 02/09/2008 - BELGIQUE - ANVERS**

19.20 – Oil refining

       At 11.57 AM a power failure occurred in a refinery. The supply of electrical power was cut off, as a result of the failure of the main power line during maintenance. Because of this the refinery was almost completely powerless, which led to an emergency shut down of the whole plant. The automatically operated safety systems started working : large quantities of products were dumped in the emergency torch and were burnt off. Safety valves opened and released gasses to the atmosphere. Personnel and people working at the refinery were evacuated and only an emergency staff remained at the plant.





Information at the central operating desk about what was going on in all the components of the plant was sparse. In the first hour after the incident it was not known which safety valves were opened and which products were ventilated into the atmosphere. That information became available bit by bit during the cause of the afternoon.

One of the safety valves that opened released an amount of ca. 70 kg H₂S into the atmosphere. The release point is situated at about 40 m above ground level. After 5 min, the cloud of H₂S formed reaches a downwind distance of about 3 km with a concentration valued at nearly 10 ppm 3 m above ground level. After 20 min the cloud has traveled 14 km and has reached the Netherlands. Concentration levels in the cloud vary between 0.64 ppm at ground level and 0.06 ppm at the top of the cloud at an altitude of about 850 m.







Driven by a wind from the south-south-west at 45 km/hr, the cloud proceeds over the western part of the province of Brabant and after about 70 min has reached the city of Dordrecht, 50 km from the refinery. Concentrations of H₂S in the cloud are about 0.06 ppm, still well above the smell detection level.

No warning of the H₂S spill was issued, partly due to a lack of information at the plant, partly due to a lack of communication between Belgium emergency services en the Dutch authorities.

A population of about 100.000 people was in the path of the cloud and potentially affected by it. An estimated several hundred people were affected by the H₂S and experienced nauseous ness, and respiratory problems. 57 people needed medical care. However the Dutch emergency services were not prepared to deal with the situation, due to lack of information about the event and its possible consequences. This in turn led to insecurity and a loss of confidence in the capacity of the government to deal with incidents like these.

     **ARIA 36654 – 07/08/2009 - 13 - SAINT-MARTIN-DE-CRAU**

49.50 - Pipeline transport

       A leak was discovered on a crude oil pipeline (diam.: 40", maximum service pressure: 40 bar, built in 1972) composed of welded rolled tubes. The accident occurred on a Natura 2000 site in the Crau Natural Reserve, home to several protected species. A park warden sounded the alarm and the operator activated the pipeline's emergency plan.

Rescue crews and various administrative departments were onsite by 8:30 am. Aerial reconnaissance was performed and a safety perimeter set up. A "geyser" 3 to 4 m high gushed from a "buttonhole" rupture 15 cm wide and 1.8 m long on the longitudinal weld.

The Prefecture convened a crisis monitoring cell at 11:15 am. The Secretary of State for Ecology arrived on the scene at 4:30 pm, and the court was seized.

The Prefecture requested a precise evaluation of environmental impacts. According to the operator, the pipe break was due to a fatigue crack caused by the "roof effect" at the level of a longitudinal weld bead. The damaged tube was replaced by a new one; others were inspected and reinforced as a preventive measure.

5,4000 m³ of crude oil were discharged over a 5-ha land area.

Surveys, coring and analysis of land are made to thoroughly assess the impact of pollution on the area. The water table is situated between 9 and 12 m depth, 72 piezometers were gradually installed in the following months to monitor the impact of pollution on groundwater together with a hydraulic barrier to contain the possible migration of the pollution. Analyses carried out regularly by the operator of the pipeline at the request of the authorities showed that no hydraulic capture downstream, either for irrigation, animal feed or human consumption, has been affected. Many studies were conducted to assess the impact of the accident on the local fauna and flora of the reserve. However, the consequences are difficult to assess beyond the polluted area due to a lack of accurate baseline even within a nature reserve. The Coussoul (flora) is yet destroyed over 5 acres.

A year after the accident, the operator claimed having spent 50 million euros to "treat" the consequences of the leak, including a dozen for environmental restoration. On the whole, at the end of 2010, more than 73 000 tons of contaminated soil have been disbursed, then transported to a processing centre of a neighbouring department. These lands came from the stripping of polluted soils over a 40 cm depth. In the 5 ha area, a depositing was carried out with local materials transferred from a nearby quarry, respecting the original structure of the soil. The surface layer was reconstructed by directly transferring the Coussoul taken from areas not yet exploited of the quarry. Scientific monitoring is planned to observe the recovery of this Coussoul. The work is completed April 15, 2011.

Given the succession of accidents that occurred during 2009 in the chemical and petroleum industries, as well as in the pipeline transport of hazardous materials sector, a meeting on industrial safety and environmental protection was organised in September 2009 between the Secretary of State for Ecology and key leaders in these sectors.

Participants submitted proposals for improving safety at their installations, by means of strengthening controls and maintenance on ageing facility, while paying greater attention to ecologically-sensitive zones with the aim of better caring for protected species / zones.

Further to this accident and as an experiment, the Secretary of State launched in August 2010a project to build a natural reserve near the affected area to "cultivate assets" that could offset negative impacts on biodiversity. For that purpose, a specialized company will restore rare and endangered species habitat by transforming an industrial orchard in a pasture zone.



Risks deriving from the coexistence of automatic and manual systems



Toxic release following an uncontrolled chemical reaction

ARIA 40319 - 21/09/2010 - Germany - Heilbronn

20.5 – Chemical Manufacturing

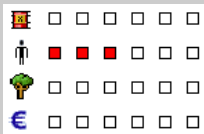

An exothermic runaway chemical reaction abruptly occurred within a production facility when an operator initiated an automated sequence to add water inside a multi-purpose batch reactor. The reactor suddenly experienced a pressure build-up due to its foaming content, but the automated control system was not able to regulate it. The glass reflux condenser burst while the rupture disc remained unbroken, given that its bursting pressure had not been reached. The irritating HCl vapours released in the facility are evacuated outside by an employee through the ventilation system. These vapours intoxicated 7 people in the neighbourhood, 2 of whom would be kept in hospital overnight for observation.

The investigation conducted revealed that the sudden exothermic reaction followed a 30-litre spill of water into the reactor instead of the 3-litre quantity indicated in the procedure. The 32-litre water tank was connected to the reactor via a pipe fitted with 2 valves. The first valve, activated by the automated control system, normally delivers 3 litres of water, while the second manual valve is supposed to stay in the closed position at the beginning of this water addition sequence. During the accident however, the manual valve was left open, and this oversight led to quickly draining the 30 litres water content of the tank into the reactor. The exothermic reaction was triggered, and the sole control system designed to prevent chemical runaway was unable to function properly, since the system was designed to provide a control of the water added to the reactor through the closure of the second valve. Moreover, the manual valve, which was not equipped with an open/closed position indicator, could not be easily reached by the operator, making it difficult to control. This risk of exothermic reaction had been identified during the process safety study (i.e. the Hazard and Operability Study, or HAZOP), but at the time of the accident only a call for procedural improvements had been issued. The company limits the maximum volume of water which can be added at one time in the reactor and improves the automated control system. The safety studies (HAZOP) are updated for all exothermic reactions carried out on in this apparatus. A particular attention is paid to consequences of operating failures and a balance is found between risk control measures and the potential severity of the consequences.

Risks deriving from the coexistence of automatic and manual systems

Production constraints and technological breakthroughs have promoted the development of automated production systems in the industry since the beginning of the 1980's. In some instances, these modern systems still coexist with older manual devices kept in order to accommodate degraded mode operations (malfunction, maintenance, unit shutdown or start-up). Accident data suggest however that this coexistence entails its share of risks.

A key circumstance during the accident sequence is the malfunction or unavailability of the automated system. When installations are controlled in manual mode, the operator's role becomes critical to ensure effective continuation of the process, or its restart or transfer into safety mode. With little practice in this type of control procedure, which is often more taxing on personnel than the automated mode, operators are prone to commit errors that eventually lead to accidents. One of the most common scenarios is failing to control whether the valve is open or closed (ARIA 8138, 23074 and 31023) or shutting off a vital piece of equipment like a pump (ARIA 7176 and 8231), yet situations in this category might also entail confusion (ARIA 35821) or the late detection of instrument malfunction (ARIA 14619 and 30920).

The analysis of these accidents shows that apparent human errors tend to hide organisational deficiencies [1]. Despite the existence of operating procedures (sometimes nothing more than simple verbal instructions), the operator may suddenly have to handle a manual operating mode that has not yet been mastered due to a lack of training and/or regular practice. Under such conditions, fatigue and stress can appear (ARIA 38418), along with difficulties in correctly ascertaining the physical and chemical state of the process [2]. The operator might thus be placed in a position of acting too hastily or slowly, leading to the accident in spite of being convinced of having acted appropriately and completed all necessary steps (ARIA 6327, 8138, 24665, 3536 and 30920).

Automated systems lie at the heart of process control systems, for the primary purpose of handling hazardous substance. They are also used as part of associated safety equipments. Operators may choose to bypass these equipments, especially during restart phases or transient phases when such equipments might not be well adapted to exceptional operating conditions. Production constraints can also create temptations of bypassing an automated system which is limiting the process performance [2] due to limitations imposed by an automated sequence or an unstable operating regime (ARIA 6537 and 38148). The smallest control error in manual mode operation can easily trigger an accident in the absence of an automatic mechanism able to detect, and eventually correct the misguided course (accumulation of explosive product: ARIA 164 and 6537; toxic leak: ARIA 19295 and 32484; chemical runaway: ARIA 212). The accidental aspect is more evident when an automated safety system is bypassed; because such systems may be considered to be of little use, as their activation are rare while any malfunction will significantly disturb the process operation: false alarms, untimely emergency shutdowns (ARIA 2900, 11107, 21466 and 36496). Safety systems are also responsible for setting process operating threshold conditions that may be tempting to bypass or violate in order to increase the production (ARIA 17531 and 38674). The incentive to bypass automatic systems may be even stronger if this bypass is short, giving the false impression that it has no consequences, such as equipment testing (ARIA 32484).

Even under normal operating conditions, the Heilbronn accident (ARIA 40319) shows that maintaining a manual system on a process, whose control has since been automated, creates an "accident-prone" environment when the results of the risk analysis are not completely applied. "Edge effects" from the old manual system on the new automated system are also possible, such as the unwanted activation of an equipment responding to both types of control systems (ARIA 1690 and 3212). This kind of environments becomes even more "accident prone" when the automated system only partially replaces its manual counterpart (ARIA 184, 11181 and 21136), as the operating speed of automated equipment can surprise the operator in charge of conducting the manual phase of the process (ARIA 38431). Shifting from automatic to manual mode during production also leads operators to commit errors, due to a lack of adequate training/practice on this more demanding and less often used mode (ARIA 31630 and 35432).

For over 30 years, the automation of production and safety systems has undeniably made it possible to reduce industrial accident risks, especially with regard to processes that use or manufacture materials with a high hazard potential (pressure, temperature, flammability, toxicity, etc.). However, this streamlined approach to executing routine control and monitoring tasks has paradoxically compromised operators' capabilities to face unusual situations. In this kind of situations, a reliance on manual controls systems is often unavoidable and shall be taken into accounts in accident scenarios analysis, equipment ergonomics, maintenance strategies, design of operating procedures and operators training.

Bibliography :

[1] LORY M. and MONTMAYEUL R., The accident and the organisation - Collection Synthèse, Editions *Préventique*, 176 p., 2010, ISBN: 978-2-911221-47-8.

[2] BARPI - Human and organisational factors as part of the accidental mechanisms in fine chemistry, September 2007, available on : http://www.aria.developpement-durable.gouv.fr/ressources/in070139maj26_09_07.pdf

Additional references (detailed accident reports) :



- ARIA 3536: Explosion and fire of a hydrogen peroxide unit
- ARIA 8231: Accidental release of solvents
- ARIA 30920: Ethylene release into the atmosphere
-

Accidents whose ARIA number has not been underlined are described on the Website :

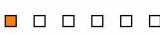

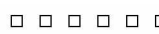
www.aria.developpement-durable.gouv.fr

  **ARIA 164 - 27/04/1989 - 39 - TAVAUX**
 20.13 - *Manufacturing of other basic inorganic chemical products*
 Inside a chemical plant, an electrostatic filter for removing dust, containing 696 plates sized 17.5 m x 7.5 m x 18 m on a 116-MW coal-fired boiler, exploded. The accident occurred during a restart procedure after a two-week shutdown for maintenance ; it resulted from the accumulation of 440 m³ of gas inside the boiler following failure to close the backup burner feed line (300 m³/hr), which had been opened 1 hour and 20 minutes before the accident and which was discovered 90 minutes after the accident. One manual valve and two automatic gate valves stayed open (no visual control of valve position, automated shutoff of gate valves while continuing to inject compressed air, warning message ignored). The explosion caused 1 death and 8 injuries among the technician staff. Shattered window panes and projectiles were observed up to 250 m away. Total property damage was estimated at 20 MF.

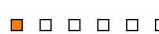

  **ARIA 212 – 19/07/1990 - UNITED STATES - CINCINNATI**
 20.12 - *Manufacturing of dyes and pigments*
 A rupture disc broke on a reactor used in the manufacturing of acrylic resin during pumping at the bottom of a device containing a hot mix of cleaning solvents. The reactor had been heated under manual control without following procedures or employing automated control mechanisms ; the installation's residual temperature had risen too high. The resulting vapour cloud exploded; 2 technicians were killed, 60 other employees were hurt and 30 individuals outside the facility were physically affected. At least 1,000 neighbours and 80 subcontracting personnel had to be evacuated. Property damage was extensive and losses were evaluated at 120 MF (\$23 M).



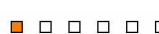

  **ARIA 3212 - 08/04/1991 - 71 - LE CREUSOT**
 25.30 – *Manufacturing of steam vapour generators*
 Fitted with an automated regulation system and continuously operated without supervision since 8 February 1991, an overheated water boiler (19.2 MW, 160°C, 11 bar) exploded during a manual control phase upon attempting to transition to a boiler with less capacity. The accident was caused by gas accumulation inside the firebox following the untimely opening of 2 solenoid valves in series, responsible for controlling the burner feed line. An electrical short tied to a previous cabling configuration, retained unexpectedly when installing the automated control system, wound up triggering a control relay switch common to both valves. No victims were reported; property damage, though significant, remained confined to the unit in question.





  **ARIA 3536 – 22/04/1992 - 38 - JARRIE**
 20.13 - *Manufacturing of other basic inorganic chemical products*
 An explosion, noticed tens of km away, and a fire destroyed 1,000 of the 4,000 m² contained in a hydrogen peroxide (H₂O₂) unit located in the vicinity of hydrogen and chlorine tanks. The fire spread into the sewers, and a nauseating odour was perceptible. A safety perimeter was set up. One employee died and 2 others were injured; property damage was assessed at 483 MF. In escaping from an insufficiently-sized retention basin, 1,000 m³ of fire extinction water containing solvent polluted the DRAC River. This accident stemmed from a deficient electric power card within one of the unit's digital control system cabinets. Several elements then entered into play, worsening the situation : analytical obstacles ; ill-advised human intervention on the automated device ; partial automation of the unit's emergency shutdown sequence ; non-independent control/safety protocols acting on the same instruments ; inadequate controls in place for ensuring the successful execution of installation safety procedures combined with several manual operations not completed by technicians when facilitating the unit shutdown sequence ; a lack of specific safety recommendations on installations ; and confusion written into the recommendations and existing procedures. Due to defective seals on the safety shutoff devices (pump discharge valves, automatic regulation valves), backflow of hydrogen peroxide from the extraction column towards the oxidiser made it possible to gradually increase concentrations in the reactive mass of powerful and destabilising H₂O₂-metal agents, whose exothermic decomposition was initiated and then accelerated. The resulting oxygen caused installation pressure to rise along with a burst in the connecting pipe, which had never been fitted with a safety valve or equivalent device. The reactive mass, partially drained from the production machinery, ignited at a hotspot. Organisational deficiencies in terms of safety training would provide the grounds for a legal suit filed 3 years hence against several senior plant managers. Many technical and organisational improvements were undertaken following this accident : installation of impermeable safety shutoff equipment, protection of pipe sections prone to pressure increases during H₂O₂ decomposition, command/control system upgrade (with a safety system dedicated to emergency shutdown independent of the process control system, a new control room, enhanced workstation comfort and ergonomics), increased installation retention capacities and sewer protection, redefinition of subcontractor tasks and greater focus on information/training, issuance of appropriate safety recommendations, completion of safety reports relative to H₂O₂ manufacturing, transfer and storage procedures.

  **ARIA 6327 – 27/03/1986 - 69 - DECINES-CHARPIEU**
 71.12 - *Engineering activities*
 Within a research centre, a study was conducted to improve output of the phenol oxidation reaction using hydrogen peroxide. During cleaning of the piston reactor with water at the end of the first test, an explosion caused projectiles to be released. One of the technicians positioned adjacent to the pilot installation was seriously injured (temporary deafness due to the explosion). Property damage was minimal (partial destruction of the micro pilot). The accident was caused by a mechanical malfunction on the phenol line as well as by shutdown of the hydrogen peroxide pump. This shutoff sequence was poorly interpreted by the technician, who manually reactivated the pump. Excess peroxide in the reactor led to a runaway reaction and the eventual explosion.

  **ARIA 7176 – 26/06/1995 - 56 - LANESTER**
 21.10 - *Manufacturing of basic pharmaceutical products*
 A security officer smelled solvent near an underground cistern containing 30 m³ of dimethylacetamide (DMAC). The tank, built without a retention basin, was placed onto a simple concrete slab and closed on 3 sides. When a technician forgot to stop a pump in degraded mode (manual operations, without servo control), solvent continued to be distributed. Since the flow control valve was closed (for an unknown reason), pressure in the circuit rose and a leak occurred on a PVC flange. The DMAC dissolved this flange, and 3 m³ of product spilled into the stormwater collection network, then into the PLESSIS River and LORIENT harbour; 100 m³ of water were required to dilute the product. All PVC flanges were subsequently replaced by stainless steel parts.

  **ARIA 11181 – 25/04/1997 - 62 - CALAIS**
 20.14 - *Manufacturing of other basic organic chemical products*

 An exothermic reaction involving diethanolamine and thionyl chloride in solvent phase, initiated 16 hours earlier, yielded chlorhydrate and a gaseous effluent neutralised in a washer after exposure in a glass column. Following a whistling noise, the column burst at 9 am. A toxic cloud (composed of HCl/SO₂) drifted onto a street adjacent to the plant, where residents had to be evacuated. The internal emergency plan was activated: 13 people suffered from intoxication and were hospitalised 15 min later. The unit had been automated for a year. The flow/reagent/agitation servo control mechanism, planned at the outset, had never been installed. One of the 4 technicians well versed in plant operations acknowledged an (agitation) alarm at the beginning of the reaction. The stirrer had remained turned off. The accident occurred upon manually restarting agitation after an electrical outage in the workshop.





  **ARIA 14619 – 30/09/1998 - 44 - INDRE**
 20.15 - *Manufacturing of nitrogenous products and fertilisers*



 At a fertiliser plant, a dense and whitish cloud was released into the atmosphere during a 30-minute period subsequent to a pH disorder on the gas washing device set up in the granulation workshop. Technicians did not respond quickly enough to this operational drift given that the installation was running in manual mode since the regulation system had been disassembled the same day for maintenance. The site operator modified the alarm sound signal to make it perceptible beyond just the control room. The automatic regulation system for neutralising washing juices was improved.





  **ARIA 17531 – 7/09/1999 - 91 - GRIGNY**
 46.71 - *Wholesale of fuels and ancillary products*



 Around 11:30 pm, a strong smell of hydrocarbons was indicated by residents living near a petroleum depot located along the banks of the Seine River immediately after the pipeline delivery of 2,640 m³ of unleaded gasoline. Arriving onsite at midnight, fire-fighters halted all rail and river traffic in the depot vicinity, yet were not allowed inside the facility since the local manager of the operating company had refused assistance from external responders. When the Prefecture cabinet director showed up at the scene around 3 am, fire-fighters were ultimately authorised to intervene and observed the overflow of a gasoline tank. The associated retention basin, which had received several m³ of the gasoline collected, was covered by a foam blanket. This operation was complicated by an insufficient flow rate and pressure on the premixing network, as well as by the removal offline of a portion of the fire protection network following a valve rupture.





Despite the absence of any serious consequences, this accident still would have generated a major risk in the event of ignition. The classified facilities inspectorate issued the following observations :

- The tank that overflowed was not being directly fed, but instead fed via several intermediate tanks positioned higher and filled by the pipeline beyond their "upper" and "very high" limits, with these levels being balanced thanks to gravity ;
- For this purpose, the upper and very high level alarms were bypassed, thus depriving the site of a line of defence, given that the signal retransmission necessary for the pipeline operating company to halt delivery upon alarm signal detection was no longer available ;
- Subsequent to a modification in the internal electrical network at the depot from a few months prior, the operator was unable to restart the facility's fire pumps from the backup power supply (electric generating set) ;
- The fire water network had not been entirely functional: due to a leak on a network tap, the operator had blocked a portion of the premixing network, thus creating the difficulties encountered by fire-fighters during the night ;
- Onsite safety organisation was clearly flawed, leading the operator to ignore the deficiencies inherent in his own depot.



A prefectural order imposed a number of emergency measures : shutting off pipeline supply to the depot while waiting for service to restart, reading tank level probes, and producing an accident report. The operator received an official injunction to restore the fire water network to full capacity within 24 hours. Feedback had not been taken into account by the site operator, who had already undergone at least 6 incidents involving depots over the previous 8 years.



  **ARIA 21466 – 12/09/2000 - 30 - ARAMON**
 21.10 - *Manufacturing of basic pharmaceutical products*



 A leak of over-pressurised and overheated glycol water occurred at a chemical plant after the rupture of a pipe joint. At 2 am, a technician recorded a drop in coolant temperature (150°C), preventing vacuum drying operations from continuing. On-call staff diagnosed a loss of communication link between the utility automation feature and the plant's digital control system. A specialist in such systems confirmed the defect of a card on the utilities automation, whose replacement had been postponed until the next morning. Once the specialist left the premises confident of his diagnosis, the on-call technician decided to restart the unit. He short-circuited all of the safety mechanisms for hot fluid, as noted by the supervisor, and replicated the corresponding settings in manual mode. Called by another workshop an hour later, the technician abandoned the post for 30 min. Upon his return, the hot fluid had exceeded 180°C, and a noise resembling a detonation shook the plant. After joint rupture, the glycol water vaporised on the premises, which were closed immediately thereafter. The only consequence of this incident was a production loss. A plant working group suggested several remedial measures: revise access to the various system levels; reduce the number of staff members certified to take part in the programme and prioritise access ; train subcontracted personnel depending on their access authorisation; install cabled safety systems ; improve decision-making system reliability at night or outside of the normal schedule.

  **ARIA 23074 – 6/04/1979 - FRANCE**
 19.20 - *Oil refining*



 Inside a refinery's catalytic cracking unit, an explosion occurred on a layer of gas at ground level. Following a level drop in the decoupling drum of the gas washing process, the manual valve for allowing water to enter opened. The water level rose in the drum due to a deficiency in the drum's regulation control chain before the manual valve could be closed. To accelerate drainage, the drum's regulation valve bypass towards the flare was opened even though the bleed valve of this same drum had remained open without supervision. The butane contained in the reflux drum then freely entered the flare decoupling drum and ultimately reached the sewer, forming a layer of gas at ground level. A flash was quickly triggered and the technician, caught in the explosion, was killed. The accident led to a temporary shutdown of refinery installations. The origin of this flash may have been the lamp used by the technician, given that the accident happened at night. The shock of the valve square driver on a piece of machinery or ignition of the gas cloud on the slurry reboiler (reputed as the catalytic cracking unit's heaviest liquid effluent) at 325°C, adjacent to the drum and sewer, are two other possible causes. The C4 distillate cut had contained a high concentration of trans-butene-2, whose self-ignition temperature lies below 320°C.



     **ARIA 24665 – 26/05/2003 - 13 - PORT-DE-BOUC**

20.14 - Manufacturing of other basic organic chemical products

   At a facility specialised in manufacturing basic plastics, a biphasic leak occurred on the safety valve of a bromination reactor containing 2 tonnes of dichloroethane with 5% bromine chloride (BrCl). Spreading of the mix remained confined to the production plant, as well as within the released cloud of hydrogen chloride. The facility's internal emergency plan was activated. Internal responders used a "water blanket" to limit both evaporation and the risk of inflammation, in addition to cleaning the premises ; all liquid wastes were transferred to an impermeable tank. Rail traffic on a nearby line was halted as a precautionary measure. The emergency plan was lifted 2 hours after the accident, with no injuries reported. Excessive reagent (BrCl) flow was the cause of pressure rise inside the reactor and safety valve operations: the intake control valve had been temporarily replaced by a manual valve as part of a maintenance operation. During the days prior to the incident, repeated clogging had led to changing the recommended position of the manual valve. To avoid such an accident from recurring, various remedial actions were implemented: design of the reagent loading line to ensure the flow rate always lies below the effective vent discharge rate ; improved tracking of temporary modification requests ; installation of a filter on the reagent loading line to prevent the risk of clogging; a study of the safety valve network in order to minimise the risk of vent clogging via a biphasic drive.



     **ARIA 31630 – 14/03/2006 - 45 - SEMOY**

20.59 - Manufacturing of other chemical products (not otherwise classified)

   At a chemical plant, 3 kg of methyl ethyl ketone (MEK) were discharged through the safety valve on a reactor following a pressure rise (to 50 mbar) inside the reactor. Solvent vapours escaped via the vents and spread both in the unit and outdoors on site premises. Upon noticing the odour, technicians checked all reactors in the zone and remarked that the temperature of one of them had reached 91°C, far surpassing the recommended 50°C. The heating circuit was closed and the cooling system activated. The accident occurred after loading raw material (MEK and 1,4-dioxane) at the time of setting heating conditions : the position of the temperature regulation loop in manual mode while the regulation valve remained open caused the excessive heating. Noncompliance with control instructions when beginning to heat the reactor was specifically cited. Moreover, the very high temperature alarm threshold had been set at 150°C and temperature readings were not being recorded. The measures adopted subsequent to this accident focused on: introducing controls and monitoring procedures for batch reactor heating, improving the modification tracking procedure used in safety reviews (regarding alarm thresholds) ; accepting completed works; and verifying alarm thresholds during temperature indicator calibration.

     **ARIA 32484 – 8/11/2006 - 77 - GRANDPUITS-BAILLY-CARROIS**

20.15 - Manufacturing of nitrogenous products and fertilisers

   In a chemical plant producing fertilisers, an ammonia release at the level of the hot ammonium nitrate solution station intoxicated 4 employees, 2 of whom were working for a subcontractor. The installation was placed in safety mode and local fire-fighters were notified. The 4 injured personnel were all hospitalised for exams and cleared to leave 5 hours later.

The accident occurred even though the unit in question had been operating since the previous evening. Regulation of the nitric acid (HNO₃) flow rate, which is usually an automated process, was switched to manual mode when encountering difficulties in stabilising the reaction medium pH. A maintenance service call had been scheduled at 9 am on the day of the accident. During this service call, the low flow and high flow safety mechanisms were inhibited for the time it took to complete testing. After manipulating the nitric acid intake valve, the flow of HNO₃ stopped suddenly, causing an excess build-up of ammonia in the reactor. The technician unsuccessfully attempted to reactivate the flow safety mechanisms, before deliberately tripping the reactor. Basic vapours were then discharged via the facility's vents and by the degassing of non-recycled condensates discharged into the gutters crossing the unit.



A defective nitric acid valve caused this accident : a broken pin was found inside the station at the time of its disassembly. This equipment problem could not be detected before disassembly, and the control room relay did not indicate any defect.

The lack of a unit-wide alarm, compounded by an inadequate risk analysis prior to maintenance work, was also cited.

As for feedback from this accident, personnel training improvements were envisaged, especially aimed at temporary safety device downtime and the installation of ammonia detectors connected to an alarm.

     **ARIA 38418 – 28/08/2008 - UNITED STATES - INSTITUTE**

20.20 - Manufacturing of pesticides and other agrochemical products

   At a pesticides plant with 520 employees, a 17-m³ tank used to treat methomyl residue in a particular solvent (methyl isobutyl ketone, MTBK) suddenly rose in pressure at 10:20 pm and exploded 15 minutes later. The explosion severely damaged the production unit, ripped pipes and caused a fire fuelled by the 8 m³ of product present in the tank. Onsite teams responded, with assistance from external fire-fighters, in accordance with a mutual emergency response protocol.

The site is adjacent to a major university and a river. Police closed the nearby motorway. The operator's failure to inform authorities, specifically regarding potential toxic releases, slowed the coordination of emergency measures; authorities ultimately decided to confine 40,000 local residents to their homes for 3 hours. The fire was extinguished at 2:45 am.







Two employees, dispatched to verify the cause of a tripped pressure alarm on the tank, were killed (1 instantly, the other 41 days later as a result of extensive burns). 6 fire-fighters and 2 employees of a rail company present onsite were intoxicated; 1 required a full day of hospitalisation. Damage (mainly shattered windows) on buildings and vehicles was reported up to 10 km away in areas located downwind, though the majority of losses were within a 2.5-km radius. The extent of damage outside the site amounted to \$37,000 (€25,000).

A tank 25 m away, protected by an anti-projection shield and containing 6 tonnes of methyl isocyanate (MIC), was hit by debris yet did not leak, thus preventing spreading of this highly toxic product (the same that caused the Bhopal disaster (ARIA 7022)).







The U.S. Chemical Safety Board conducted a survey that found the accident to be primarily caused by organisational flaws: lack of sufficient oversight during the start-up phase with a new computerised control system; inadequate training of technicians in use of this new system; noncompliance with written start-up procedures (in need of updating), including the circumvention of measures aimed at controlling critical risks. Other exacerbating factors were also cited: cursory safety study prior to restart, equipment in poor working order, insufficient communication during shift changes, employee fatigue caused by working conditions at the time of restart (overtime hours, stress) Moreover, the operator deliberately sought to withhold information, particularly as regards the facility's MIC storage, behind the excuse of anti-terrorism laws.







The residue treatment tank as well as the unit's entire control system had been revamped during a long summer down period. Production started back up prematurely due to a strong demand for the product.

A series of problems on the production chain upstream of residue treatment absorbed technicians' full attention and led to concentrations of methomyl in residues, exceeding 20% despite an authorised maximum of just 1%. Under normal operations, residues would decompose in the tank; gasses were treated and the solvent was used to fuel other parts of the plant. Since a safety bypass had been circumvented, the treatment tank could not be filled ahead of time with "clean" solvent or preheated; moreover, the liquid level remained very high (due to an automated governor forced to operate in manual mode), producing excessive residue concentration and leading to a runaway reaction and the eventual treatment tank explosion.

      **ARIA 36496 – 15/07/2009 - 57 - SAINT-AVOLD**







      *20.14 - Manufacturing of other basic organic chemical products*







      Superheater "A" on vapour cracking unit no. 1 at a petrochemical platform exploded around 3 pm. Of the 8 personnel present at the time, 2 were killed and the other 6 injured. Projectiles, composed mainly of refractory material, were sent distances on the order of 100 metres and some pieces close to 50 cm in size fell in the immediate vicinity of the superheater; a dust cloud was visible directly above the site.







      The Internal Emergency Plan was activated : the plant was evacuated and 70 fire-fighters arrived at the scene. Of the 6 injuries, all requiring hospitalisation (including 2 subcontracted employees working onsite), 5 were released the same evening. No damage or other impact was recorded offsite, outside of the sound of the blast. Cylindrical in shape with a 5-m diameter and some 20 meters high, this water vapour superheater, tied to a chimney of the same height via a connecting cone, did not contain any toxic product. The explosion was not followed by a fire outbreak. Subsequent to violent atmospheric storms during the night of July 13th to 14th and with water infiltration entering a utility room disturbing the digital control system, vapour cracking line 1 had been shut down and placed in safety mode. This line's restart procedure was launched in the morning on the day prior to the accident. This procedure was long to carry out, since the start-up routine had to be performed section by section. On 15 July, superheater A was reset around 3 pm with the intention of a manual ignition. A technician had shown up with an adjustable pole to light the pilots when the superheater exploded. The bodies of this technician and a second employee were found underneath rubble from collapse of the superheater floor.







According to the site operator, this accident resulted from various causes, namely :

- an accumulation of flammable gas, still below the flammability limit : investigations conducted forwarded the hypothesis of a gas flow towards a burner during both the start-up phase and ignition step ;
- ignition of the dust cloud by the lighting pole or by a hotspot inside the superheater convection zone. Other ignition sources could be hypothesised as well (e.g. electric spark, static electricity), although the two identified above appear to be the most plausible. A number of circumstances facilitated the occurrence of this accident, whose severe consequences were due to the presence of personnel in the vicinity at the time of powering up the facility ;
- failure to proceed with a vapour cleaning of the superheater prior to restart, in violation of operating protocol ;
- gas intake through a burner in the absence of a flame on the corresponding pilot ;
- the technical safety barrier, according to which it is prohibited to supply burners without a visible flame on the pilot, was not operational. This barrier was composed of an automated mechanism that closes gas feed valves if the flame detector is not signalling the presence of a flame 10 seconds after valve opening. Following a number of erratic detection alerts shortly after installation, this automated detector mechanism was deactivated due to the limited number of shutdowns/restarts planned for the unit over its operating cycle.

      **ARIA 38431 – 10/05/2010 - 26 - PIERRELATTE**

      *20.13 - Manufacturing of other basic inorganic chemical products*

      At a plant specialised in transforming material containing uranium in addition to fluorine products, a leak estimated at 3 kg of fluorine (F₂) occurred on one of the two stations for filling bottles with a gas mix composed of fluorine (at 10% and 20%) and pressurised nitrogen (N₂).

      Around 10:30 am, a technician began the packing of 4 racks simultaneously, 2 on station "A" and 2 on station "B". These racks were already pressurised internally at 50 bar and needed to reach 105 bar. The technician had previously prepared the installation (with the appropriate F₂/N₂ ratio) by introducing compression on backup station "C", which had since risen to a pressure of 70 bar. Around noon, he stopped the simultaneous filling of both stations, with the pressure inside all 4 racks on the order of 90 bar. Only the filling of station "A" was continued. At 12:11 pm, the pressure of station "A" racks equalled 105 bar. Since their filling cycle had been completed, the automatic switch took place, to allow filling station "B" racks, whose pressure had remained at 90 bar. The technician removed the station "A" racks to replace them and then continued with the production schedule, which entailed opening the gate that had served to confine the packing installation. At 12:21 pm, station "B" racks reached their 105 bar target, at which point the automated mechanism transferred the compressed F₂/N₂ mix back onto station "A". The technician however had not had sufficient time to replace the station "A" racks, and the F₂/N₂ mix was discharged to the outside at a pressure of 10 bar via the packing clips. At 12:30, in-house safety teams shut off the compressor, which in turn stopped the discharge. After examination by the plant's medical staff, 3 employees who had experienced slight discomfort were allowed to return to work a few hours later yet remained under 24-hour medical observation as a precautionary measure.

This incident was caused by the technician's erroneous judgment of the set-up, assuming an internal pressure of station "B" racks at 50 bar instead of 90 bar. This faulty assessment stemmed from the simultaneous filling of stations "A" and "B", given that such an operation had not been prohibited by the installation control system. The installation was shut down, and the Hazard and Operability Study (HAZOP) had to be revised so as to redefine safe operating conditions for the site.



Operations in a degraded mode



Thermal decomposition of fertilisers inside a dryer

ARIA 37825 - 08/02/2010 - 60 - Ribecourt-Dreslincourt

20.15 - Manufacturing of nitrogenous products and fertilisers

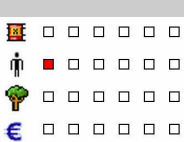
 When observing yellow smoke emanating from the chimney of a drying unit located downstream of the fertiliser plant granulator, an employee notified a control room technician; the workshop extraction fan was turned off at 10:30 am in order to limit discharges of both nitrous and chlorine gases, which were beginning to fill the workshop. A technician was overcome by the gas and required hospitalisation for a few hours as a precautionary measure. The internal emergency plan was activated at 10:58 am, and fire-fighters arrived on the scene at 11:10. The dryer was started and then flooded; the incident was brought under control at 12:34 pm. The device was drained, with all fire extinction water collected in a retention basin; recovered sludge was recycled over the following week. A few hundred kg of aggregates were decomposed ; the 20 tonnes of system load were recycled that very night.

Thermal decomposition had occurred inside a dryer, of the rotating tube variety, fed with hot air by a 7 MW natural gas generator containing 20 tonnes of aggregates, over which an ammonium phosphate slurry had been sprayed. This ammonium phosphate supply was obtained by means of a chemical reaction between phosphoric acid (H_3PO_4) and ammonia (NH_3). The site operator considered the possibility of accidental overheating, since the NPK 11-11-32 fertiliser had not been prone to self-sustaining decomposition. The unit had been shut down for the maintenance of a chain conveyor. The pertinent operating instructions would have been followed for this mission, given that the granulation loop contained dry matter, with the burner operating at the minimum setting (35%) and the drying drum no longer rotating.

Subsequent to an excessive production temperature ($> 300^\circ C$), the "dryer input" temperature, which was also abnormally high, surpassed the temperature at the onset of dry fertiliser decomposition (i.e. $> 170^\circ C$). This thermal disequilibrium was caused by use of an H_3PO_4 at 38% concentration, which was more diluted than the normal level (53%). With a slurry containing a large quantity of water to be evaporated, gas temperature at the reactor output (set at $110^\circ C$) decreased, while the drying air temperature was automatically increased as a compensation to $300^\circ C$, by exceeding the typical threshold of $240^\circ C$. No alarm was triggered, with the $300^\circ C$ value remaining below the $370^\circ C$ threshold recorded on the "hot air intake" temperature probes. Afterwards, the dryer required more time to cool.

The acidic dilution stemmed from an incident that had occurred 10 days prior, involving the unit's three H_3PO_4 tanks, two containing a 53% acid and the other a diluted corroded acid ($< 30\%$). With its shell leaking at a height of 1.5 m above the bottom, tank contents had been transferred into the other two tanks, thus diluting the acid used for manufacturing purposes.

The operator modified production standards, by introducing a "hot air intake temperature" alarm threshold adapted to each production run ($260^\circ C$ for ammonium nitrate fertilisers), along with the relevant maintenance shutdown procedure by indicating temperature controls and thresholds correlated with the steps required for installation shutdown, plus an internal emergency plan reminder to avoid stopping the fan in the event of toxic gas emissions.



Crédit photo : Do Visser / De Gelderlander / R.R.

Explosion of ethanol vapours inside a vacuum belt filter

ARIA 40097 – 11/07/2010 – The Netherlands – Nijmegen

20.15 – *Manufacture of other chemical products*

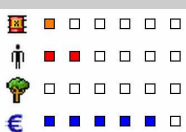

In a chemical plant producing mainly cellulose derivatives, an explosion and fire occurred at about 4 pm during the restart of a production line stopped for 9 h after a breakdown.

The commissioning of the vacuum belt filter by the team leader caused the explosion and several fires started in several points of the line. An employee of 52 years was seriously injured. Despite being rapidly cared of by firefighters, he died from his injuries later in the evening.

The fire lasted 38 hours, causing thick black smoke; public spaces were enclosed within a radius of 3 km and residents were asked to confine themselves at home. The navigation on the WAAL is interrupted for several hours. A fireboat protects acid and hydrogen tanks. In the evening, the mayor announced that smoke analysis eliminated any health-related risk.

The procedure governing the operation of the filter dated back to 2005, it stated that the filter had to be purged with nitrogen for maximum 2 hours before being restarted. However, technicians indicated that in practice, the purge was carried out only if the doors of the filter had been opened. Otherwise, even in case of long-lasting stopping of the filter, no purge was launched. It was "assumed" that the air was saturated with ethanol and thus above the upper explosive limit (UEL).

The day of the accident, the temperature in the confined space of the belt filter vacuum was between 24 and 35°C, leading to a volume percentage of ethanol vapours between 5 and 15 %. The stoichiometric ratio of reaction of ethanol with oxygen is 5.6% by volume. An explosive atmosphere was thus created and inflamed with a low activation energy, causing the loud explosion. The amount of ethanol vapour in the filter is estimated at 100 m³ (with about 300 kg of liquid ethanol).

An explosion scenario in the filter had been studied, and its theoretical effects did not overpass the enclosure. This accident shows that the power of solvent vapour explosion is often undervalued and possible sources of ignition of explosive atmospheres (ATEX) poorly studied. It stresses the importance of identifying and managing situations of degraded mode of operation, as well as ATEX prevention measures, including inerting.

The insurance estimated internal damage up to 50 million euros. The company fired its 65 employees and transferred its production in China. The Labour inspectorate requested another factory producing CMC 25 km away to revise its explosion prevention plan and related protective measures.

Operations in a degraded mode

The expression "degraded mode of operations" refers to the situation of a system whose operations are sustained or kept on course without possessing all of the functional resources necessary or normally allocated upon completion of the corresponding risk analysis, whether such resources are organisational or technical in nature, i.e. : competent personnel in appropriate numbers; availability of a machine, a utility or a function; lack of raw materials or consumables.

The pursuit, even temporary, of operations under these conditions, without any study of the implications through a risk analysis (ARIA [5611](#) / Continued operations despite cyclohexane leaks) or without specification and implementation of targeted compensatory measures (ARIA [7022](#) / Operations without a cooling circuit, without nitrogen or a backup tank) within the scope of a unique organisation that requires at the least information regarding the full set of individuals involved, i.e. supervisors, technicians, subcontractors (ARIA [37440](#) / Information on technicians assigned to use a mechanical gauge onsite and on control room technicians, due to malfunction in the level measurement system), exposes actors to "encounters" whose consequences may be unfamiliar to them. Any deviation in operating conditions could in fact prove hazardous, since the safety of individuals, property and the environment merely depends on a set of improvised responses of moderate relevance, which in turn rely upon information and resources available in real time to those capable of recognising the importance and acting expeditiously (ARIA [3536](#) / Improvised action on the unit's control system, [7022](#) / Lack of an operable siren, unavailability of an emergency plan).

The system operator may be aware of this degraded mode of operations and of the need to implement compensatory measures that correspond to a level of risk comparable to the reference level. Given the magnitude of other constraints, which may be technical (ARIA [5611](#) / Need to halt production for a long period in order to conduct reactor repairs) or economic (ARIA [7022](#) / Risk of commercial loss), the operator might also underestimate risks subsequent to a summary analysis and then introduce insufficient measures (ARIA [717](#) / Malfunction of a cold air unit, lowering output to a minimum and injecting hot ammonia into a cryogenic tank).

Moreover, the operator may lack the time required to perform such an analysis and adopt appropriate measures once the source of degraded operations has been identified ; rapid dynamic events such as runaway reactions receive special attention here (ARIA [7135](#) / Generic accident involving a runaway phenol-formaldehyde reaction subsequent to insufficient reactor cooling). These types of situations often reveal inadequacies in the initial risk analysis, or a failure to incorporate feedback (ARIA [7135](#) / Reaction ongoing for tens of years), or the onset of undetected deviations with respect to the adopted benchmark (ARIA [37902](#) / Technicians failing to employ the protocol specified in safety manuals).

In the absence of an appropriate reaction that allows bringing the situation back to normal or "restoring" the situation, the degraded mode of operations, or partial operations, whether in an overloaded or slowdown mode, could result in a "loss of process control" (ARIA [20382](#) / Excessive inflow of residual gas in order to increase boiler output rate, [19295](#) / Unit operating in slowdown mode to prepare for upcoming repairs).

The ARIA database has catalogued many incidents involving a degraded mode of operations known to the site operator and originating from not only physical defects, but sometimes and more importantly organisational and human breakdowns :

- An emphasis on "ensuring safety on paper" while overlooking in situ controls : ARIA [34990](#) / Heavy corrosion of gasoline pipelines that had been poorly monitored as the result of being considered acceptable by a specialised inspection body, with the lack of appropriate diagnostics leading to delayed and inadequate maintenance of installations:
- Standardisation of allowable service deviations : ARIA [25900](#) / Basins used as storage facilities / degraded operations becoming routine, [30304](#), [37902](#) / Non-use of a safety feature that was interfering with handling.
- Deliberate installation safety lapses: ARIA [25900](#) & [32484](#) / Manual mode of operations, alarm override.
- Phenomenon of "ageing" and insufficient maintenance (ARIA [24923](#)...).
- Installation of a "temporary" nature or inappropriate modifications / deferred, incomplete repairs (ARIA [37597](#) / Delayed repairs subsequent to an erroneous assessment) or repairs completed "in haste" (ARIA [595](#), [608](#), [5118](#), [5611](#) / Supervision with a short-handed staff, stopgap and improvised installation modification, absence of testing, [6958](#) / Sulphitation tower temporarily supplied by an SO₂ tanker truck for the time required to repair a sulphur oven burner [19122](#), [37476](#), [37597](#) / Erroneous assessment of installation conditions, exaggerated optimism over the service life cycle prior to upcoming repairs, [21460](#) / Service reactivation of an installation before repair work has been fully completed).
- Installation overuse or application of excessive loads: ARIA [5791](#), [7043](#), [7879](#), [20382](#), [30304](#), [36349](#), [36387](#), [37825](#) Excessive thermal load correlated with the quantity of water to be evaporated.
- Design flaws with partial automated mechanisms, insufficient redundancy inherent in safety devices, non-positive safety design, inappropriate materials: ARIA [608](#), [3536](#) / Partial automation of the unit's emergency shutoff switch, non-independent control and safety devices, [31691](#) / Non-independence of regulation/safety functions, non-positive safety, [32814](#), [34990](#) / Pipe lining poorly adapted to marine corrosion, [37088](#), [37720](#) / Alarm system in need of repairs, inadequate pipe material.
- Poor design (ARIA [19119](#)) or premature wear (ARIA [5611](#) / Rupture due to shear of the bellows).
- Equipment defect or malfunction (ARIA [636](#), [3536](#) / Defective automation card, [4687](#), [24020](#) / Gradual deviation in process parameters, malfunctioning and unrepaired equipment, [24923](#), [36877](#), [37440](#) / Malfunctioning of automated level controls, [37720](#) / Permeable retention basin undergoing repairs), instrumentation with late or inadequate information relay and lack of positive safety features: ARIA [25900](#) / Placing alarms offline, [31691](#) / Defective pressure sensor, [32016](#) / Malfunctioning remote communications lasting several days.
- Breached seal, obstruction, clogging : ARIA [3536](#) / Regulation valves without an impermeable seal, [25900](#) / Retention basin connected to the stormwater drainage network.
- External physical causes (ARIA [32679](#) / Downed electrical supply line on the German network interfering with French network supply).
- Naturally-occurring aggressions : ARIA [17321](#) / Storm and site flooding, [32240](#), [34990](#) / Corrosive saline fog, [37720](#).

- Intentional malicious acts : ARIA 32016.

The available accident records also indicate a number of cases in which compensatory measures were missing or insufficient due in particular to :

- Overly broad or inadequate risk analysis : ARIA 174, 608, 5118, 6958 / Introduction of connection components without any real analysis of the risks for an SO₂ leak on a flange, 7879, 19145, 21315, 24020 / Unidentified risk of thermal decomposition, poorly-defined scope of process safety and "foam plug" preventing rupture of a safety disc, 25900 / Retention basin connected to the stormwater drainage network, 31691 / Glass debris clogging a tap, 36387, 37476 ; the transient phases of a process and one-time or exceptional operations are especially singled out herein : ARIA 636, 13099, 19117, 19119, 32440, 36368, 36490, 36797, 36877, 37087, 37088, 37476.
- Design / ergonomics of equipment or workstations : ARIA 174, 608, 636, 19117, 19119, 20507, 21315, 37087, 37088, 37440 / Local mechanical gauge; inconvenient repair protocol.
- Absence of instructions and procedures (ARIA 24020), incomplete, inappropriate or noncompliant: ARIA / 636, 753, 3536 / Lack of clarity in available procedures and instructions, 4687, 5118, 7879, 17152, 19117, 20507, 25900 / Absence of work guidelines, measurement devices rendered inoperable, 36368, 36490, 36877, 36881.
- Poor internal management: ARIA 32016 / Depletion of spare parts inventory.
- Insufficient monitoring and controls : ARIA 753, 4687, 15725 / Hasty repairs for final permeability testing campaign, despite the tank storing higher-density phosphoric acid 24020 / Gradual and undetected deviation in process parameters, 34990 / Inadequately monitored corrosion.
- Improper diagnostics, maintenance delay (ARIA 34990 / Corroded gasoline pipelines not receiving adequate monitoring as the consequence of being considered acceptable by a specialised inspection body, lack of appropriate diagnostics leading to delayed and missed maintenance of installations. For the site's other pipelines, this accident led to adopting new compensatory measures).
- Diagnostic error, poorly analysed precursor events, insufficient feedback : ARIA 21315, 24923, 31691 / Drain tap clogged for 3 weeks goes unnoticed, sulphur dichloride leak during maintenance work, 37440 / malfunctioning automated level control replaced by human observation with local recordings ; tank overflow and UVCE, unaware control room technicians failing to recognise the initial signs of tank overflow, 37597 / Poor evaluation of installation conditions.
- Ill-prepared, hasty or inappropriate human intervention, due to a lack of training or (more seriously) performed by personnel either poorly equipped, uncertified or unskilled : ARIA 636, 3536 / Centralised control system left accessible to all personnel, whether certified or not, 4687, 5118, 7879, 13099, 17152, 19117, 19145, 21304, 21315, 36797.
- Lack of an emergency intervention plan: ARIA 25900.

The starting point consists of a preliminary definition, within the initial risk analysis, of special operating conditions ; these entail taking into account the various hazardous situations and identifying both the stable phases of a process and the protocol for returning to initial states. Such an analysis is critical for accidental mechanisms with rapid kinetics, which leave little room for reaction should the degraded situation not be diagnosed from the outset : ARIA 3536 / Thermal decomposition, 7135 / Runaway reaction.

Though all life cycle phases of an installation may be concerned, chief among them are daily production operations, continued service provision during maintenance phases or when conducting works often constitutes an exacerbating circumstance : ARIA 5611 / Installation modified by means of circumventing a reactor undergoing repairs, 6958 / Temporary lorry supply due to a furnace undergoing repairs, 13099, 21315, 21460 / Equipment placed back into service without first being completely repaired, 24020 / Mechanical stirrer shut down 48 hours for maintenance, 25900 / Retention basins used as storage capacities during the works period, 31691 / Ongoing sensor maintenance, 37476, 37720 / Retention basin undergoing renovation with momentary removal of its antacid liner.

The multiple causes sometimes cited as part of accident evolution are very often on display here, as reflected in featured events that have often been listed several times in previous paragraphs. Operators can thus decide to continue activities at any cost by whatever means available or scale activities back to just the "vital functions", while maintaining installation safety, despite the functions themselves being capable of deteriorating or degrading over time, subsequent to potential deficiencies in the backup resources either implemented or available: electric generating set, power inverter, cooling unit, etc.

Without being able to avoid degraded operations by introducing appropriate measures such as preventive maintenance or via organisational steps like early detection of weak signals, a specific protocol beyond mere economic constraints needs to be adopted in order to continue operations at a level of safety comparable to the reference guideline. Such a protocol, which is best designed to match the stakes involved, typically features reinforced monitoring of the state of degradation for the targeted function, in addition to introducing remedial measures and close performance tracking. This response presumes supplemental controls on sensitive installations and machinery, which normally implies deploying additional human and equipment resources (ARIA 34990 / Reinforced monitoring procedures, 37597/Daily monitoring). The implementation of compensatory measures could aid in preventing worst-case scenarios, as well as in mitigating and intervening when an incident or accident arises, more specifically in cases where prevention efforts have been thwarted (ARIA 37597 / Sand dams in the retention basin, regular pumping of hydrocarbons, gutter for channelling flow, replacement of the surface layer on polluted gravel).

Beyond some of these purely technical measures and in order to avoid improvised decision-making as much as possible, customised training intended for response teams (including management) during "crisis situations" will effectively complement the existing physical resources at industrial sites.

Additional references :



- Detailed accident reports ARIA 717, 3536, 5611, 5620, 7022 and 24020.



Accidents whose ARIA number has not been underlined are described on the Website :

www.aria.developpement-durable.gouv.fr

  **ARIA 717 - 20/03/1989 - LITHUANIA - JONOVA**

24.1J - Production of fertilizer and nitrogen compounds

  In a fertilizer plant located 12 km from a city with 40,000 population, a cryogenic ammonia (NH₃) tank weighing 10,000 tons and filled to 70% capacity suddenly experienced a pressure rise and burst at its base. Under the impact of the wave gushing through the gaping opening, the tank separated from its platform, was pushed in the opposite direction and destroyed the reinforced concrete protection wall before coming to a stop 40 m from its foundations. A 70-cm high pool of liquid NH₃ spread over the site and took 12 hours to fully evaporate. A flare stack ignited the vapours emitted and the fire reached the 55-kt NPK storage area ; the thermal decomposition of these stocks lasted 3 days. The toxic cloud (NH₃, NO_x) contaminated an area extending over 400 km². The official casualty reports indicated 7 dead and 57 injured among the plant's operating personnel and construction crews working in the area. Local authorities evacuated the high-risk zones once the ammonia concentration of the air had exceeded 10 mg/m³; in all, 32,000 people were displaced.



  The single-sided ammonia tank, insulated using perlite, was fed by a production unit (at a rate of 1,400 tons/day) located 600 m away. A few hours prior to the accident, one of the two liquefaction turbochargers was shut down for some lengthy repair work. One hour before, the second turbocharger was stopped for a short repair job. Operators were not easily able to activate the backup piston compressor and rerouted the NH₃ flow to a pressurized storage area. Fourteen tons of hot NH₃ (+ 10°C) were nonetheless introduced into the lower part of the cryogenic tank, whose gaseous atmosphere rose quickly in pressure. Despite the presence of relief valves, the tank bottom deformed and then burst. The rollover phenomenon anticipated by some was not confirmed by expert assessment.

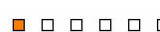

  The subsequent investigations showed :



- that greater strength of the tank lid, in comparison with the bonds in place between the internal chamber sidewall and the tank bottom or with anchoring brackets, caused tank failure at its base, as the tank bottom remained fastened to the foundations ;
- the liquid ammonia wave caused the protection wall to break, before spreading over a much wider surface area, thus aggravating the consequences of the accident ;
- this protection wall strength was not in compliance with the specifications stipulated during plant design as a result of modifications made at the time of construction in order to reduce material and labour costs. During construction, other modifications were supposedly introduced for the same reasons at the storage foundations and its anchorage device.

  **ARIA 3536 – 22/04/1992 - 38 - JARRIE**



20.13 - Manufacturing of other basic inorganic chemical products

  An explosion perceived tens of km around and an ensuing fire destroyed 1,000 of the 4,000 m² of a hydrogen peroxide unit (H₂O₂) located near a series of hydrogen and chlorine tanks. The fire spread into the adjoining sewers, and a nauseating odour permeated the air. A safety perimeter was set up. One employee was killed and 2 others injured ; property damage was valued at 483 million francs and 1,000 m³ of fire extinction water containing a solvent polluted the DRAC river after having overflowed from a retention basin that had an insufficient volume.



  This accident was due to a defect in the electrical supply card in one of the unit's control system (digital command control) cabinets. The situation was exacerbated by : difficulties encountered when analysing the situation, an unfortunate attempt of human intervention on the automated system, partial automation of the unit's emergency shutdown function, non-independent control / security features, insufficient controls over the proper sequencing of installation security combined with several manual steps failing to be carried out by technicians to assist with the night-time shutdown, absence of specific guidelines for ensuring installation safety, and lastly a lack of clarity in the available instructions and procedures.



  Due to a breach in the seal of the *in situ* safety shutoff device (pump discharge check valves, automatic regulation valves), oxygenated water backflow from the extraction column to the oxidiser allowed for the reactive mass to gradually build its concentration of powerful metal agents capable of destabilising H₂O₂, whose exothermic decomposition was triggered and then accelerated. The resulting oxygen caused a rise in installation pressure and the bursting of a connecting pipe that had not been equipped with a shutoff valve or equivalent protective device. The reactive mass, which was partially emptying from the production machinery, ignited on a hot spot. An organisational deficiency in the area of safety training would lead 3 years after to filing a suit against several plant managers.

Several technical and organisational improvements were introduced at the site: installation of impermeable shutoff devices, protection of pipeline sections capable of undergoing a pressure rise during H₂O₂ decomposition, enhancement of the command/control system (safety system designed for an emergency shutdown independent of the operating control device, new control room, improved workstation comfort/ergonomics), increased installation retention capacities and sewer protection, redefined scope of site intervention, more efficient information dissemination / training, publication of adapted safety instructions, and completion of safety reports dedicated to the manufacturing, transfer and storage of H₂O₂.

  **ARIA 5611 – 01/06/1974 - UNITED KINGDOM - FLIXBOROUGH**

20.60 - Manufacturing of artificial or synthetic fibres

  A cyclohexane cloud violently exploded at a caprolactam plant; 28 employees were killed, and a total of 89 individuals were seriously hurt, 53 of them among the general public. Property loss was considerable : buildings destroyed within a 600-m radius, 1,820 dwellings and 167 businesses sustained damage.



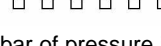

























  Caprolactam was being synthesised by means of catalytic oxidation of cyclohexane at 155°C and under 8.8 bar of pressure inside 6 reactors placed in series ; some 250 to 300 m³/hr of liquid was being conveyed by straight pipes 28" (711 mm) in diameter connected to the reactors via stainless steel expansion bellows.

  A cyclohexane leak had been detected in March of the same year on Reactor No. 5, which revealed a slight vertical crack due to stress corrosion in the presence of nitrates. To avoid shutting down production, a bypass pipe with an elbow joint was planned to connect Reactors 4 and 6. The plant was undergoing a complete reorganisation. Lacking the requisite engineering capacities and managerial oversight, a 20" diameter pipe was installed without any preliminary design, then the unit was restarted without appropriate initial controls or testing. Production resumed on April 1st and until May 29th, no problems had been reported. On Saturday, June 1st, the unit was shut down and then restarted several times, with small cyclohexane leaks apparently plugging themselves. The blast, which occurred at 4:53 pm and could be noticed as far away as 50 km, completely levelled the site and was followed by several fires producing flames rising 70 to 100 m into the air.

The investigation concluded the occurrence of a shear rupture of both attachment bellows on the temporary 20" pipe, combined with a massive leak of 40 to 60 tonnes of hot pressurised cyclohexane. The cloud formed ignited at a distance of 100 m from the leak some 25 to 35 seconds later on the hydrogen unit's reforming tower. These conclusions, delivered in April 1975, would not however meet with unanimous approval, and various theories regarding the causes of this accident would be aired in publications for decades.

The overall context of site operations contributed heavily to this disaster, with an understaffed management team (the Maintenance Manager's post had gone unfilled for 6 months), a situation not in compliance with current regulations (i.e. an inventory of hazardous products 50 times higher than the authorised limit), and a business facing serious economic difficulties. This accident would lead to a major revision in both English and European regulations.



                            **ARIA 5620 - 10/07/1976 - ITALY - MEDA (SEVESO)**





























                            **24.4 - Pharmaceutical industry**

A chemical plant that had stopped its production for the weekend released a toxic cloud containing 2,3,7,8-tetrachlorodibenzodioxin into the atmosphere : 6½ hours earlier, at the end of the shift, the production cycle of 1,2,4,5-trichlorophenol had been stopped while only 15% (instead of 50%) of the solvent (ethylene glycol) had been distilled. Agitation was stopped and the vacuum broken. No water was added to the mixture. The unit was left unsupervised for the weekend. At 12.37 pm, the safety valve, calibrated at 3.8 bar, ruptured due to the increase in temperature and pressure in the reactor.



























The heating of the reaction mixture's surface at rest initiated the secondary exothermic reaction forming the dioxin. It was only the next day that the company informed the authorities that a release of herbicide had occurred. Two days later, crops were declared unfit for consumption. The company reported the dioxin release only 10 days later. In all, 11 communities were effected, including 2,000 ha contaminated. 3 zones were defined : zone A ($C > 50 \mu\text{g}/\text{m}^2$) covers 110 ha, its 736 inhabitants were evacuated ; zone B ($5 < C < 50 \mu\text{g}/\text{m}^2$) covers 270 ha, children and pregnant women were evacuated during the day, agriculture and animal husbandry were prohibited; zone R ($C < 5 \mu\text{g}/\text{m}^2$) measuring 1,430 ha.





























More than 250 case of chloracne were diagnosed, and 220,000 people were exposed to the pollution. In all, 81,000 animals were killed or had to be put down. The quantity of dioxin released has been evaluated between 200 g and 40 kg. The decontamination of the zone began 6 months later and lasted 5 years. The topsoil of the contaminated zones, the demolished constructions and the remains of the contaminated animals were buried in 2 pits, in zone A. Wastes and materials from the plant were placed in drums for subsequent incineration. One year later, 511 people from zone A returned home and zone R returned to agriculture. Zone A was decontaminated and zone B was again declared fit for construction in 1984. The installation was dismantled. In 1985, the plant's management was sentenced to suspended jail sentences ranging from 2.5 to 5 years. The company paid more than \$240 M in damages to the residents and communities concerned. The epidemiological studies have not established a concrete link with all long-term pathologies (cancers, deformations...). Only an increase in the proportion of female births in relation to male births was observed.

                            **ARIA 6143 – 19/12/1994 - 38 - LE PONT-DE-CLAIX**





























                            **20.14 - Manufacturing of other basic organic chemical products**





























At a chemical facility producing a hormone for herbicides, an explosion accompanied by the splashing of viscous material occurred at 8:45 pm on a column used to distil dichloroethane (DCE) / methyl nitrochlorobenzene (NBE). A temperature increase at the base of the column, which had ceased 25 min earlier following difficulties encountered during drainage operations, attracted the attention of technicians at 9:10 pm. The explosion took place at the time this crew was working on the column ; 5 technicians were injured, 2 seriously (one of whom would succumb as a direct result of injuries sustained). The column equipment was completely destroyed. The surrounding environment was not contaminated. The return of an acidic solution between 2 tanks by the siphon effect and its concentration in the column caused the NBE to decompose. The unit was subsequently modified.

                            **ARIA 6958 – 06/05/1995 - 02 - VENIZEL**

                            **17.21 - Manufacturing of paper and cardboard, paper / cardboard packaging**

A 200-litre leak of liquefied sulphur dioxide occurred on the flange joint of a tanker truck whose contents were being unloaded into a sulphitation tower typically supplied by a sulphur oven (undergoing maintenance). The technician cut the tanker supply line (pushbutton control). A leak remained unplugged on the stuffing box of one of the tanker valves. The bypass valve was turned on and the alarm was tripped. The emergency response team proceeded by closing the valves and spraying the tanker. The French "red plan" for serious emergencies was activated. A plant employee, who had sustained local skin burns, remained hospitalised for 5 days ; the protective suit he wore had been stored in non-airtight premises, where it was in contact with SO₂. Within a 50-m radius, a total of 32 employees became slightly intoxicated, as did 11 fire-fighters, 4 of whom had more serious consequences. Use of an inadequate hose (for connection with the tanker flange) was the cause of this accident.

                            **ARIA 7022 - 02/12/1984 - INDE - BHOPAL**

                            **20.20 – Manufacture of pesticides and other agrochemicals**

In 1969, an American company set up a production unit manufacturing a powerful pesticide called Sevin in Bhopal. The unit included three 60 m³ tanks (50 tonnes) of liquid methyl isocyanate (MIC) (E610, E611 and E619), each connected to various safety systems : cooling facility, wet scrubber, flare and water spray system. The Indian government had granted approval for the production of 5,000 tonnes of Sevin per year.

To keep pace with competition in the insecticide market and overcome a budgetary deficit of 4 million \$/year, the parent company decided to stop the local production of Sevin, lay off numerous supervisory-level staff members (especially maintenance) and run the site at low cost... The accident took place on the night of 2-3 December 1984. After cleaning the pipes, water entered the tank E610 and triggered several chain reactions causing an increase in temperature (200°C) and pressure (13.79 bar). In 2 hours, the safety valve let out 23 to 42 tonnes of MIC and other toxic gases according to sources. Several safety systems failed: cooling facility stopped (06/84), wet scrubber out of order (23/10/84), flare out of service (a few days before the accident), temperature, pressure and liquid level indicators in the tank faulty, water curtain not powerful enough. The toxic emission took a heavy toll on the population. According to sources, 1,754 to 2,500 people lost their lives and 170,000 to 600,000 were poisoned. More than 4,000 animals (cattle, dogs, cats, birds) died as well. The chronic pollution caused by the toxic release had long term consequences on the population. The list of victims had grown in numbers by end of 1998. 16,000 people were reported dead and 15 to 20 people died each month following the accident.

Initiated in 1987, these legal proceedings were somewhat chaotic. Charged at first with homicide, the 8 detainees (7 Indians and the American company President) then benefitted from a 1996 Indian Supreme Court injunction. The highest tribunal of the nation ruled that the case should be tried as homicide by negligence, a misdemeanour punishable by at most two years of prison. In 1989, the operator signed an agreement with the Indian government: the industrialist would pay compensation in the amount of \$470 million in exchange for dropping all charges.

On June 7, 2010, the Bhopal Court of First Instance sentenced to two years of prison and 100,000 rupees (€1.751) in fines 7 individuals deemed liable for the disaster. A \$10,000 (€8,354) fine was imposed on the operator's Indian subsidiary for negligence. The company's CEO at the time, declared by the court as a "fugitive", was not specifically named when the verdict was announced.

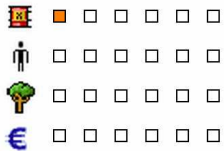

ARIA 7135 – 26/07/1995 - 60 - RIBECOURT-DRESLINCOURT

20.52 - Glue manufacturing

At a 40-ha chemical facility located on the outskirts of an urban area, the safety disc set at 1.5 bar on a 15.2-m³ reactor burst in a plant working with formo-phenolic resins used for glues applied to agglomerated material. The operator informed the Classified Facilities inspector, who promptly made a site visit.

The batch production of a formo-phenolic resin lasted 10 hours. Both formaldehyde and phenol were loaded into the warmed reactor, then the soda used as a catalyst was gradually introduced into the device, which was maintained in a vacuum. The reactor's cooling system (consisting of two double shells) and the return of emitted vapour condensates served to control this highly exothermic chemical reaction.

At the time of this event, all 3 reagents were inside the reactor when the reaction started to run away, with a rise in both the temperature and pressure of the enclosure, followed by bursting of the adjusted safety disc protecting the installation ; 6 tonnes of reactive media (formaldehyde at 11.5%, phenol at 0.6%, soda and resin) released from the roof fell both inside and outside plant premises, at distances as far as 400 m. Vegetable gardens and several vehicles received residue on their surface.

The Classified Facilities Inspectorate proposed shutting down operations of the malfunctioning reactor, given that its service start-up was contingent on filing a report indicating the exact accident causes and suggesting a framework to avoid repetition of the incident. The operator was also required to submit within 24 hours a precise and readable map of the zones affected by this chemical fallout, so as to notify local elected officials and set the stage for implementing appropriate measures. This submission was to include all documentation and information (e.g. on toxicology) required to ensure an effective assessment of the risks potentially posed to residents and occupants of the identified zones. The operator was moreover asked to propose remedial measures for treating the polluted zones, e.g. disposal of affected plantations, soil treatment.

The operator performed site cleanup work : 1,000 m³ of washing water were stored in an onsite basin. Soils and plant life were analysed, yielding: 0.02-0.87 mg/kg of phenol in the soil samples, and 0.17-4.08 mg/kg in plants. A selection of vegetables grown in neighbouring gardens was retrieved, and a wheat field in the line of chemical substance fallout was mowed ; all damages incurred were reimbursed.

After an overly rapid injection of soda, exacerbated by a high reactor loading level, reactor cooling was initiated too late (12 min after the temperature increase according to equipment recordings). The quantities of products introduced were considerable, although the plant operator insisted that the operating protocol had not been violated (15,190 kg measured by a mass flow meter, i.e. 15,792 kg per load cell for a 15.2-m³ reactor). The reaction ran away while reactor cooling devices (which had reached 127°C) were malfunctioning. The reactor loading level, combined with insufficient available cooling capacity and inappropriate temperature settings, impeded control over the reaction process. Also, the loading of all primary reagents at the beginning of the cycle, noncompliant with good professional practices, facilitated this runaway reaction. The plant had not been granted the necessary regulatory authorisations to produce this new type of resin, and no safety report for either the process or installation had been previously conducted.

The operator modified the relevant process in favour of a continuous injection of formaldehyde, leading to improved control over reaction exothermicity and runaway protection by stopping formaldehyde injection. Reagent quantities were reduced, and the monitoring of both reactor operating parameters and chemical reaction stages was improved.

ARIA 15725 - 23/04/1999 - 76 - ROUEN

24.1J - Production of fertilizer and nitrogen compounds

An older lead-lined steel tank (diameter : 8 m, height : 9 m, bottom thickness : 8 mm, shell thickness : 5-7 mm) containing 450 m³ of phosphoric acid burst at a chemical facility. The acid wave destroyed the reinforced concrete retention basin (with a combined core and wall thickness of between 10 and 15 cm). An in-house inspection had detected considerable corrosion on a generator and led to requesting a thickness verification. The maintenance team proceeded by locally reinforcing the tank (6-mm polyester layer, etc.) without actually performing the requested controls.

The proper works sequencing procedure was not respected and consideration was not given to the fact that this site had been programmed to shut down over the near term. The strength loss subsequently detected, related to a localized leak in the lead lining, affected 4/5th of total tank height. No serious environmental impact was observed. An emergency order was issued, and all site personnel were reminded of applicable procedures and informed of the inspectors' guidelines..

ARIA 17321 – 27/12/1999 - 33 - AMBES

20.15 - Manufacturing of nitrogenous products and fertilisers







A storm flooded a "Seveso"-rated fertiliser plant employing 97 staff and producing ammonium nitrate pellets.

The installation experienced a 20-hour current outage. During cleanup of a small stream running near the site 48 hours later, the 63-kV line supplying the site was affected by the outage and the plant would ultimately go without electricity for a full 7 days ; the production unit however remained operable on backup power throughout this period thanks to its cogeneration equipment.







Damages were estimated at 4.5 million francs : a loading arm was down, unusable rail track, a number of roofs and fences damaged, and an empty railcar derailed subsequent to an SNCF Railway Company switching error that routed to the site a set of 25 railcars, though the line's capacity was only designed to accommodate 22...







Several areas on the GARONNE River side of the embankment were opened and then completely submerged by the height of floodwaters (2.6 m). An 80-cm wave swept over the Ambès peninsula. The main difficulty encountered was the slow speed at which water was flowing from the ground towards the DORDOGNE and GARONNE Rivers, given that the existing discharge system (consisting of local streams, gates and valves) had not performed adequately as a result of improper maintenance. The damaged rail track throughout the zone was still unusable 2 weeks after the storm had passed, as the teams assigned to clean up and restore service required a long time to access the track due to flooded conditions.







These floods affected some 10 companies (ARIA 17316 through 17324) and underscored the vulnerability of some Seveso sites. An update of the relevant safety reports and internal emergency plans would be requested of the various site operators so as to specifically incorporate flood risks. The creation of a Permanent Secretariat for Industrial Pollution Prevention (S3PI) overseeing the 4 concerned municipalities was viewed as the appropriate entity to coordinate these problems with all actors involved.







      **ARIA 19295 – 31/05/1993 - GERMANY - LUDWIGSHAFEN AM RHEIN**







      *20.14 - Manufacturing of other basic organic chemical products*







      At an organic chemical plant, an ammonia (NH₃) discharge occurred inside a urea unit operating in slowdown mode in preparation for a repair job. A regulation valve was activated to limit the quantity of NH₃ fed to the reactor by re-injecting a portion of the flow to supply the pump; however, the valve was vibrating strongly while in this operating mode. Sensing difficulties in adjusting the quantity of NH₃ intake, the technicians partially closed a manual valve positioned downstream of the regulation valve. A short time thereafter, 500 kg of NH₃ escaped from the unit, which underwent an emergency shutdown. A water curtain prevented the NH₃ vapours from becoming airborne. This accident was due to the partial opening of a safety valve discharging NH₃ into the absorption device, causing an overload and evacuation into the open air via the washing column. In order to avoid repetition of these conditions, the operator installed orifices on the expansion pipes to evacuate liquid ammonia towards the absorption device. In short, this accident was due to human error.







      **ARIA 21460 – 23/11/2001 - 25 - EXINCOURT**







      *29.1 - Automobile construction*

      At an automobile plant, an employee working on the subcontracted dumpsite was snared in a compactor mechanism while using a pole to free boxes that had become stuck. According to initial investigation findings, the press that had malfunctioned earlier the same day was restarted before being totally repaired.

      **ARIA 24020 – 28/11/2002 - ITALY - MESTRE**

      *20.14 - Manufacturing of other basic organic chemical products*

      At a chemical plant, a tank containing a mix of toluene-2,6-diisocyanate (TDI) / tars with a high boiling point increased in pressure and exploded around 7:40 pm. The cloud ignited 5 min later ; afterwards, the fire was fed by 20 tonnes of oil and 1 tonne of toluene flowing from the burst pipes. An identical tank burst 40 min later due to a domino effect, causing a 2nd explosion whose blast extinguished the main fire.







      In-house first responders and some 60 external fire-fighters were mobilised. The external emergency plan was lifted at 9:30 pm, and the internal plan at 10:45. Projected by the blast and sprayed by viscous fallout, 4 subcontracted workers received medical treatment and would be off the job between 3 and 53 days. External property damage was assessed at €2.8 million; internal damage resulting from pressure waves and flying metal fragments was extensive and affected: supporting frames, pipes, electrical connections, and installation utility lines. Some 15 tonnes of TDI/tar mix were released. The authorities conducted pollution measurements in the industrial park sewer system, revealing TDI concentrations of 5,280 mg/l. A temporary, yet intense, pollution of the water treatment lagoon was observed over more than 1 km. The atmospheric measurements recorded indicated a major presence of No_x / carbon, along with traces of hydrocarbons (toluene, ethylbenzene).







Following the maintenance shutdown of the reactor stirrer upstream of the damaged tank 48 hours prior, temperature rose from 150° to 230°C in the TDI/tar tanks. This temperature, coupled with extensive residence time (13 hr) in the tank, prompted the initiation of TDI exothermic dimerisation, with CO₂ production as the source of this pressure build-up. A foam plug formed in the connecting pipe at the purge manifold prevented the tank's safety disc from bursting. Inspection authorities also found no evidence of written procedures relative to a degraded mode of operations (such as the presence of high temperature). Moreover, none of the associated risks or tank pressure measurements, pressure increases in the TDI/tar tanks or eventual exothermic reactions had ever been specifically identified during the process risk assessment. The tanks were designed for a max. temperature of 95°C, while the measurement scale and calibrated instrumentation were set to tolerate temperatures of less than 120°C ; moreover, temperature indicators were broken and tank pressure measurements were either missing or unusable. Prior to resuming plant activity, the operator performed a detailed safety evaluation of the entire site and undertook the technical/organisational modifications necessary to achieve and then maintain a high level of safety.







ARIA 25900 – 18/08/2003 - 21 - MONTBARD







24.20 – Production of pipes, including hollow profiled pipes and corresponding steel accessories

Within a surface treatment plant that had been closed for the summer holiday period, a leak of a basic degreasing agent (pH = 10) seeped into the stormwater drainage network and then polluted a river subsequent to a thunderstorm event. The spill stemmed from a retention basin connected to this network (yet the operator was unaware of any such connection) ; this oily liquid substance was deliberately stored in the basin at the time of maintenance work in the plant. In order to contain the pollution, emergency service personnel used an inflatable plug to block the discharge pipes leading from a stormwater retention basin. Notified at the end of the day by the Departmental Fire and Safety Centre (CODIS), the Hazardous Installations Inspectorate requested the operator to pump and dispose of 2 m³ of polluted water. On the next day, a site manager informed the inspectorate of a rise in basin water level and of the difficulties encountered in identifying a disposal service; pumping operations (on a volume of 80 m³) were to ultimately begin at the end of the day and be completed by the following morning. The increased volume of polluted water was due to the fact that the stormwater network also collects water from a small brook. The administrative investigation would reveal that the use of retention basins as intermediate storage tanks was a typical practice within the unit during maintenance work on installations or even during normal operations. The inspectorate also noted the following: the absence of both guidelines for maintenance tasks and an emergency response plan in the case of accident, unavailability of product safety data sheets, inadequate network drawings, and the inoperability of liquid detection alarms within retention areas. Lastly, the inspectorate noted the facts and proposed that the Prefect issue an official injunction imposing all necessary installation compliance work.

      **ARIA 31691 – 26/04/2006 - 60 - CATENOY**

      *20.14 - Manufacturing of other basic organic chemical products*

      Inside a chemical plant, a sulphur dichloride (SCl₂) leak on a pipeline supplying the boiler tube of a distillation column hydrolysed, thereby generating a strong emission of hydrogen chloride (HCl). This column was located in a building with a cladding that formed a sort of confinement.

      The internal emergency plan was triggered. Water curtains were activated and the external fire station was notified. 50 ppm of HCl were recorded inside the building (irreversible effect for 1 hr of exposure = 60 ppm), though readings remained below the detection threshold outside. Three in-house responders were assigned to hospital observation. Water from the activated curtain (100 m³) was collected in the fire water basin. Operating losses were valued at €270,000 (the downstream unit stayed idle for 18 days).

A pressure sensor was undergoing maintenance ; it had been diagnosed as defective after indicating a reading of 108 mbar of pressure at the boiler tube output (upper alarm threshold = 100 mbar), thus triggering closure of the valves controlling SCl_2 supply and regulating the vapour heating the boiler tube. Before replacing the sensor, the boiler tube contained 150 kg of SCl_2 and could not be drained due to the presence of glass stemming from degradation of the distillation column. This clogging situation had been known for 3 weeks, yet no remedial measures had been taken. Moreover, the pressure sensor shutoff valve, whose bolts were permanently seized and fastened, could not be closed; the technician was forced to disassemble the entire set-up, allowing air to be exposed to the DN25 tap. Since the sensor was not designed with positive safety, its electrical disconnection caused the vapour regulation valve to open, thus heating the boiler tube, whose temperature rose from 24° to 120°C in 30 min, and causing the emission of SCl_2 .

Several measures were adopted as part of the feedback provided : monitoring and intervention procedures in a degraded operating mode, modification of the sectional valve / pressure sensor assembly, introduction of a positive safety loop independent of the regulation, thereby prohibiting any automatic restart once the high pressure threshold had been reached.

This accident demonstrates that a process regulation system can in no way be equated with a safety device. More specifically, the programmable production automata satisfy a rationale and criteria that are not all known by response teams and that do not necessarily incorporate degraded modes and recorded situations.

 □ □ □ □ □ □ **ARIA 32016 - 24/07/2006 - 80 - AMIENS**

 □ □ □ □ □ □ *37.00 - Collection and wastewater treatment*

 □ □ □ □ □ □ A discharge of black wastewater polluted the Selle River and caused fatalities among the fish population.

 □ □ □ □ □ □ An alert was sounded during the morning of the following day. The pollution occurred subsequent to the

deficiency of a pumping station at the city's purification plant, leading to the direct spill of wastewater (discharged from a dry cleaners) into the natural environment via the overflow chamber.

The general station circuit-breaker, turned off at the time, was responsible for the accident. Once it had been turned back, normal operations could be restored. This malfunction would have been due either to vandalism (signs of forced entry into the electrical cabinet) or to the intense heat. Moreover, network remote monitoring was running in a degraded mode: a thunderstorm a few days prior had destroyed the remote transmission equipment at the pumping station, with information on system flaws not being relayed to the monitoring station. These safety devices could not be replaced due to an inventory shortage in the maintenance workshop, and many equipment replacements had to be carried out since the beginning of the month due to the frequent occurrence of thunderstorms.

 □ □ □ □ □ □ **ARIA 32484 – 08/11/2006 - 77 - GRANDPUITS-BAILLY-CARROIS**

 □ □ □ □ □ □ *20.15 - Manufacturing of nitrogenous products and fertilisers*

 □ □ □ □ □ □ In a fertiliser plant, ammonia (NH_3) emitted in a shop working with hot ammonium nitrate solution intoxicated 4 workers, 2 of whom were employed by a subcontractor. The unit was placed in a safe operating mode and the local fire station was notified. The 4 injured personnel were hospitalised 5 hours for medical exams.

 □ □ □ □ □ □ The workshop had been operating since the previous day. The nitric acid (HNO_3) flow rate regulation, which normally takes place automatically, was placed in manual mode due to the difficulties encountered in stabilising pH of the reactive media. A maintenance work order had been scheduled for 9 am on the day of the accident.

During the maintenance visit, both the low and high flow rate safety mechanisms were inhibited when tested. Following adjustment of the HNO_3 intake valve, acid flow stopped abruptly, causing excess NH_3 in the reactor. The technician attempted to reactivate the flow safety devices and then voluntarily restarted the reactor. Basic vapours were thus being discharged via the unit vents and by degassing the non-recycled condensates discharged into the gutters crossing the workshop.

 □ □ □ □ □ □ **ARIA 32679 - 04/11/2006 - 76 - PETIT-COURONNE**

 □ □ □ □ □ □ *19.20 - Crude oil refining*

 □ □ □ □ □ □ An incident on a German very high voltage network (Cf ARIA N°32455) caused disturbances in the power grid by generating a low frequency threshold causing several units in the refinery to switch over to the safety mode. In line with the architecture of the power supply system, only the units supplied by the utility turbo-alternators were operating. These included the utilities, the CLAUS 4 hydrogen sulphide conversion unit, SCOT tail gas treatment unit, the PLAT fuel catalytic reforming unit, the HDS gas oil desulphurization unit and the CRYO and HMP hydrogen production units.

The operator set up a crisis unit without triggering the internal emergency plan. The Propane Deasphalting Unit (PDU), Furfural Extraction Unit (FEU) and Viscosity Breaking unit (VBU) re-started on a priority basis. The operator decided to leave the CLAUS 5 unit shut while the CLAUS 4 was still operating. This loss of power supply resulted in a hot oil leak at the oil unit exchangers, spilling of the catalyst from the catalytic cracker unit FCC and the solvent (methyl-ethyl-ketone and toluene) initially onto the ground and then to the drains from the solvent dewaxing units. This accidental release resulted in the COD measured in the oily waters of the platform to exceed for several days. It is also responsible for significant flares (hydrocarbon rate > 110 g for 40 min) and the unstable load of the CLAUS 4 sending hydrocarbons for incineration (due to the overflowing of the amine tower), and triggering a high temperature alert. A sulphur dioxide concentration peak (823 $\mu g/m^3$) was recorded by the sensors of the air quality monitoring association in the town on 6 November since the SCOT unit treating the tail gases of the CLAUS 4 unit could be re-started only on 7 November due to poor load. Lastly, dispatch of butane and procurement of jet fuel from the refinery were stopped.

 □ □ □ □ □ □ **ARIA 34990 - 18/06/2008 - 971 - BAIE-MAHAULT**







 □ □ □ □ □ □ *52.10 - Warehousing and storage*

 □ □ □ □ □ □ In an oil depot, after unloading a ship, the security agent observed a leak under a fuel pipe connecting the wharf to the depot. The agent installed a recipient to collect the drips and informed the operations manager who in turn informed the head of the depot. Less than 5 litres of fuel had leaked to the ground.

 □ □ □ □ □ □ The head of the depot observed the leak and decided to install a water pipeline. He informed his superiors and the inspection authorities for classified facilities who visited the site the following day and observed several areas showing significant corrosion especially near each of the supports along the pipeline. Since the pressure in the pipeline was low during the leak, there was no significant impact on the ground.

The initial coating of the pipe was not adapted to the corrosive nature of the marine environment, temperature, high relative humidity, friction and drippings from the mooring ropes of ships. Moreover, according to the operator, the maintenance schedule of pipes was drafted following the recommendations of a specialised body that carried out thickness inspections in 2007 and that stated that the anomalies on account of corrosion were acceptable given the operating conditions of 10 bars. The facility overhaul procedure was underway but the leak occurred before the action plan could be fully implemented. On 19/06/08, the

pipeline was inspected by a company expert whose observations contributed to defining the operating conditions in degraded mode for all forthcoming unloading operations. The three other pipelines connecting the depot to the wharf were inspected a few days later (thickness measurement at areas showing external and internal corrosion detected during the 2007 inspection by the specialised body). An operations schedule was drafted based on these measurements: repair of pipelines and supports, installation of collars in sensitive areas, resistance tests, replacement of sections, application of bituminous coating, application of a coating using basic metal deposits obtained by welding, specific protection under mooring ropes, excavation of soil under the pipes running along the banks, etc. The operator decided to reduce the pressure in the pipeline in question to maximum 3 bars and reinforce surveillance until the operating conditions were back to normal. The operating procedures were accordingly modified.

      **ARIA 37440 – 23/10/2009 – PORTO RICO - BAYAMON**

19.20 - Oil refining

An explosion occurred around 12:30 pm in an oil depot at a refinery ; 21 of the 40 hydrocarbon tanks caught on fire. Flames were visible several kilometres away, with a dense, black and toxic smoke released. A state of emergency was declared in five neighbouring municipalities ; a total of 1,500 people were evacuated, schools were closed and both air and road traffic was rerouted. Several drivers were injured by exploding car windows, while others were intoxicated from the smoke ; 3 rescue workers were also hurt. A shake measuring 2.8 on the Richter scale was recorded; dwellings and industrial premises were damaged at a distance of over 1.6 km from the explosion, and window panes were reported shattered several kilometres away. Local residents were asked to remain indoors due to the toxic smoke. The authorities prepared a stadium to accommodate up to 30,000 evacuees if necessary. Fire-fighters brought the fire under control on October 25th, at which time residents were allowed back home. Damages were estimated to run above \$6.4 million.

America's independent accident investigation commission (CSB - Chemical Safety Board) sought to identify the causes of this accident; according to initial findings, a gasoline tank was being filled from a boat. This tank had apparently overflowed, with gasoline spreading over the floor and forming an inflammable cloud 600 m in diameter prior to reaching an ignition source northwest of the site. The liquid level in the tank could not be determined, as the corresponding automated control system was not operational. Field technicians used a mechanical gauge on the outer tank wall, while control room technicians were unaware of the imminent danger resulting from tank overflow.

ARIA 37597 – 07/08/2005 - 76 - GONFREVILLE-L'ORCHER







19.20 - Oil refining

In an oil refinery, a leak was detected on crude oil tank A607 with a nominal capacity of 60,000m³ and filled at over 50%. Ground pollution covered several square metres from the extreme western edge of the tank until reaching the sump located a few metres from the tank shell. According to the operator, who was unable to visually observe any external corrosion either on the shell or on the visible section of the tank bottom and who relied on general renovation works conducted in 2000, with complete replacement of the tank bottom and foundation reconstruction and with feedback provided by other leaks (which had evolved slowly in a controlled manner), the tank's structural integrity was not considered suspect. The tank was kept operating under daily monitoring that took the form of rounds with : introduction of sand dams in the retention basin, regular pumping of spilled hydrocarbons, creation of a gutter to channel flow towards the sump, and replacement of the surface layer containing polluted gravel.

Six successive filling operations were conducted through Sept. 6th, when during the evening a sudden increase in the leak flow rate (20 m³/hr) was noticed at several points. On Sept. 7th, it was decided to drain the tank, and the crude oil was routed to the site's distillation units. The Classified Facilities inspectorate was informed of the event in the afternoon of the next day. In addition to verifying the tank's complete drainage, a technical inspection on Sept. 13th confirmed the presence of a few areas of seepage around the edge of the tank base, along with pollution over the entire retention basin surface area (and puddles of oil several centimetres thick in some areas). The inspectors also identified contamination in retention tanks A209 and 201, which were independent of tank A607. A decree ordered the issuance of incident reports on all 3 of these tanks as well as cleanup of the corresponding retention basins.

The expert appraisal of tank A607 revealed many internal corrosion pits on the tank bottom metal sheets and along welds with a leaky zone, plus the absence of a lining to protect against internal corrosion when replacing the bottom in 2000 ; two additional cases of leaks on this site's crude oil tanks would be identified in 2007 and 2009 (ARIA 33077 and 36502).

The operator installed an epoxy lining on the tank bottom prior to resuming operations and decided to extend this measure to all other onsite crude oil tanks. A penal court fined the operator €800 for failing to file the incident with the Classified Facilities Inspectorate.

      **ARIA 37720 – 08/01/2010 - 51 - MATOUGUES**

10.31 - Transformation and conservation of potatoes

A pipeline burst around 2 pm at a plant devoted to the transformation and conservation of potatoes; 11 of the 13.5 m³ of the 32% hydrochloric acid (HCl) from a 30-m³ tank leaked, to a point of filling the retention basin.

An on-duty watchman noticed a strong irritating odour around 10 pm and sounded the alert. HCl was discovered shortly thereafter in a gutter running parallel to a suppressor room located near the tank. A 20-m safety perimeter, demarcated by ribbons and metal containers, was set up around the installations. The stormwater basin outlet was plugged by an impermeable ball. Personnel working in the site's packaging zone were evacuated as a result of odours emanating from the stormwater drain pipes.

At 10:40 pm, two equipped individuals observed that the tank's retention basin was not well sealed and moreover that HCl began spreading on the ground along the suppressor utility room, over the adjacent lawn and onto the pavement. The tank leak was brought under control around 11 pm by successfully closing the bottom valve. The polluted stormwater remained confined while awaiting a decision regarding its disposal; this decision was made the following afternoon, in consultation with the Classified Facilities inspectors.

Also on the next day, pollution measurements at 3 points, conducted with fire-fighter assistance, showed no anomalies. The wind blew in a way that favoured dispersion of the emitted acid vapours, and fortunately the plant was located in the middle of a field with no dwellings within 1 km of the installation. The pH of effluent contained in the basin could be verified, as was the absence of chlorine gas in both the pipes and packaging sector. The Classified Facilities Inspectorate and local gendarmerie also made visits to the site.

The packaging zone was fully ventilated before personnel were allowed to return to work inside. The operator decontaminated the site by recovering a maximum quantity of HCl on the ground for tank storage. The bituminous pavement and utility room were both cleaned. The stormwater collector pipes were rinsed for 4 hours with abundant quantities of water. The pipe break was due to frost (-4°C at the time of the incident); moreover, the basin was not impermeable around the bottom slab / lower wall intersection. By undergoing maintenance, the tank was missing its antacid protective liner; HCl was thus spread over the pavement and adjoining land, before spilling into the collector connected to the stormwater drainage basin. A piping system made with more efficient material was installed. The basin was restored to good working order. The alarm warning of an abnormal drop in HCl inside the tank was upgraded. The damaged stormwater pipeline was placed under camera supervision, and the internal emergency plan was revised.

ARIA 37902 – 06/01/2009 - 72 - SABLE-SUR-SARTHE

21.20 - Manufacturing of pharmaceutical preparations

During a surprise inspection at a pharmaceutical plant, the Classified Facilities inspection authority noted that technicians were not complying with safety guidelines guaranteeing their radioprotection in the case of an incident when recharging radioactive sources. Such sources, implemented to sterilise medical accessories, were placed in 2 metal frames or holders at the bottom of a pool and in a safe position during the recharging operation. Sources were handled with poles, equipped at one end with a small chain to avoid any uncontrolled rise to within 3.5 m of the pool surface. During the follow-up visit held on December 9th, 2009, the inspector observed the same safety shortcomings and procedural noncompliance. According to the operator, the safety device was not being used given that its encumbrance impeded pole handling. The operator agreed on January 15th, 2010 to respect the conditions laid out in its guidelines and declared that the event had no consequences for personnel or the environment. Nonetheless, a Class 1 rating was issued on the INES scale due to the potential consequences of an individual's exposure to ionising radiation and noncompliance with the safety manual.



Monitoring of equipment characteristics

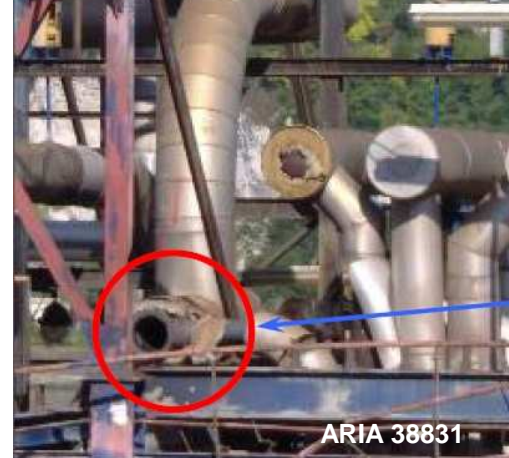

Rupture of an overheated water vapour pipe

ARIA 38831- 28/06/2010 - 76 - Le Grand Quevilly

20.15 - Manufacturing of nitrogenous products and fertilisers

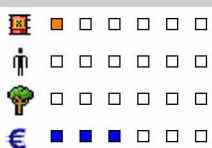

At 11:15 pm, a violent and loud bursting occurs within an ammonia (NH_3) synthesis unit at a SEVESO-classified nitrogenous fertiliser plant. The convex base welded to a heat-insulated, high-pressure water vapour pipe connected to catalytic reforming equipment had burst prior to ignition. The base, a 40-kg block of steel, was projected longitudinally. Inside the shop area, a walkway was ripped off its supports damaging an access ladder. The steel base crossed the ammonia confinement space 25 m further, without causing any damage, then flew over an ammonium nitrate conveyor belt only to

land 230 m away in a parking zone for tanker cars full of ammonia awaiting shipment, which on that day happened to be empty. The water vapour, circulated at 520°C under 120 bar of pressure in the pipeline, tore apart the asbestos cement cladding on the wall located 20 m from the original rupture and escaped into the atmosphere with a load accompanying noise. The two employees present in the unit at the time cut off vapour supply to stop the sound, shut down production operations and cooled the steam reformer with nitrogen. At 11:50 pm, the plant's internal emergency plan was activated by the operator, yet he failed to sound the siren or notify neighbouring localities. Alerted by the outside noise, local residents called emergency services around midnight; first responders arrived onsite with a crew of 55 men and several utility vehicles. No intervention was required on their part. Upon hearing the vehicle sirens, some residents stepped out onto their balconies or made their way to the periphery of the plant since the municipality was unable to provide information about the ongoing incident. No victims were reported and the site's other units were not adversely affected ; no operations had to be interrupted. The damaged unit was shut down for several weeks, which in turn caused shutdowns at special fertiliser production units due to the loss of vapour.

The site operator only reported a slight amount of rust at the level of the break in the convex support and a hole on the inner wall of the outlet tube. A metallurgical assessment of the base indicated that slow creep had initiated on the outer skin, which combined with flow into the material layer was the cause of pipe rupture. This hypothesis relied on the detection of oxidised, yet non-deformed, pipe openings in the presence of intergranular microcracks on both the pipe and its base. The origin of this creep was explained by the metallurgical composition of the base, i.e. ordinary carbon steel containing no alloys and not adapted to temperatures above 425°C. The pipeline was made of a slightly-alloyed P22 type steel, which was more resistant to creep and compliant with the original specifications defined 32 years prior for both material elements. Inspections carried out at the time on the convex base did not detect any noncompliance of the steel, given that non-destructive technology had not yet come of age. This creep might have been accelerated as a result of heat treatment performed at 700°C during equipment installation, once the assembly had been welded. Periodic inspections dedicated to pressurised equipment on the damaged pipe were only recorded into the log 25 years after service start-up, at the time of applying for facility recertification. The initial recertification was rendered official without any underlying structural documentation (misplaced), and subsequent inspections never focused on the section of pipe that would burst.

Nine months before the accident, the in-house inspection team had requested adding the mode of "degradation by high-pressure vapour pipe vibrations" to the unit's pipe inspection routine, following a break in the drain valve of a high-pressure pipe when restarting operations at the unit. On the day of the accident, this mode had not been included in the inspection programme. Classified Facilities inspectors requested a materials control of all unit pipes before restarting operations; this additional step revealed 12 other noncompliant steel components (a tee junction, tap, base, flange, etc.).



Bursting of an oxygen pipe

ARIA 38436 - 13/06/2010 - 57 - Richemont

20.11 - Production of industrial gases

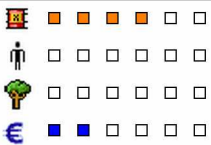

On a SEVESO-rated air liquefaction site with supply lines primarily serving the local industries, an oxygen (O₂) pipeline under 40 bar of pressure burst at 1:45 pm 2 m deep, at the spot where it had run underneath an infrequently used railway line (4 trains per month, according to the site operator). The facility's internal emergency plan was triggered; 30 fire-fighters and local gendarmes were called to the scene. The plant's clients were duly informed. At 2:30 pm, a reading of 26% O₂ was recorded a distance of 5 m from the isolated pipe section. The operator issued a press release at 6 pm.

At the installation, two unsheathed O₂ pipes and an N₂ pipe with a concrete sleeve were placed close to one another. The N₂ pipe, feeding the safety systems of several plants, could not be shut off instantaneously ; Classified Facilities inspectors thus requested reducing its pressure. The site's output was not affected, and N₂ distribution continued after setting up a safety perimeter and installing a surveillance camera for the zone. Built in 1974 and routed beneath the rails passing through a concrete conduit, this pipeline made of E24-4 steel (DN 300, thickness: 4.9 mm, min. Thickness : 4.3 mm, max. service pressure : 44 bar) and spiral welds was lined by a coal tar pitch and cathodic protection (-1.4 V). Immersed in water, this oxygen pipeline was laid out over a 1-m swath. A crater 7 m in diameter and 3 m deep was formed in the ground due to the blast, with clumps of soil and fragments of pavement / concrete being ejected 50 m (heavier debris weighing 15 kg was projected 30 m, while lighter material - i.e. 1 kg - was displaced 60 m). A nearby concrete wall was partially destroyed and the fence severely damaged. The TNT equivalent mass was evaluated at 0.14 kg ; no fire was ignited along the pipeline, however a 220 / 24 V transformer did catch on fire 3 or 4 m away. No works were being carried out in the vicinity, and moreover visual inspections and recordings had indicated no pressure surge. As recipient of a report on the circumstances surrounding this accident and internal emergency plan execution plus a technical review (pipeline characteristics, soil analyses, etc.), the Classified Installations inspectorate requested a series of metallurgical and geotechnical appraisals. Tube samples were submitted to expert evaluation after a 2-month outdoor rest period. By August, inspectors had been able to record the overall state of corrosion and ordered the tubes be placed in indoor storage.

Several hypotheses were forwarded : installation defect, quality of the soil / fill material, and differential settlements of poor quality ground layers due to the railway line. In an initial report, the expert observed that these phenomena so obviously present on the surface were not recorded and moreover foresaw corrosion of the installation. The soils contained a considerable amount of high-chloride water. The relatively shallow water table (depth of 2.2 m) was in fluctuation (Moselle River). This corrosion could have been more pronounced due to extended periods of immersion, sulphate-reducing bacteria or chlorides, all of which may explain the corrosion craters formed on the external tube surface. Replacement of a section of pipe 5 m away from the point of rupture and the unexpected elongation of a pipe end were both also noted.

Initial feedback under the heading "pipeline transport of hazardous substances" addressed :

- Activation of the internal emergency plan as opposed to the "PSI" plan, for an accident occurring near the site boundary on a pipeline instead of an "in-plant conduit". The limitations of this plan were announced by indicating in the various safety reports whether the pipeline was covered in all or part by the internal emergency plan.
- An internal emergency plan revision was required to underscore the "unique features" of this set-up : presence of the railway, production unit (classified with environmental protection impacts), other pipelines.
- The safety report complement in the areas of installation techniques and geotechnical / hydrogeological sector characteristics, in order to better grasp the "landslide" hazard.
- Revision of distances with regard to the effects caused by sudden pipe bursts, including: the crater, damaged wall, and material projections. Both the pressure surge responsible for such damage and the energy needed to move an equivalent volume of earth were to be evaluated. In addition to verifying data from generic "safety reports" conducted by the operator, the zones designated "ELS", "PEL" and "IRE" associated with such pipeline configurations should have been better defined.

Monitoring of equipment characteristics

Production equipment present on industrial sites may be subjected to intensive use cycles over extended periods, given that its useful life cycle can in some cases surpass 30 years. As such, the risk management strategy must pay special attention to monitoring the changes in characteristics of equipment used to transport or handle hazardous substances, as well as to the conditions capable of altering such equipment. While the regulatory language relative to Pressurised Equipment addresses certain risks, it does not encompass all vulnerable equipment found at an industrial site, hence the need for an adapted and formalised monitoring campaign, as prescribed in Classified Facility legislation (with emphasis on applying the Ministerial decree of October 4th, 2010, or the subsequent decree issued on January 26th, 2011 for pipelines carrying hazardous substances). The accident at Le Grand Quevilly (**ARIA 38831**) shows that organisational mistakes committed during monitoring, even those considered minor at first, are capable of causing serious accidental consequences over time (in this case, the impact on pressurised ammonia reservoirs could have been avoided).

The first organisational anomaly associated with this accident pertains to the missing technical specifications on the unit's piping layout. Even though non-destructive material control methods were not available in 1978 when the equipment was built, a rigorous examination of this file would have detected noncompliance in the steel used for this convex base and for the unit's 12 other noncompliant devices. At the very least, a file review would have raised questions regarding the relevance of conducting material controls given the lack of information therein at the time of the initial recertification application required in 2000. Without adequate traceability and monitoring, the materials or construction methods introduced may not have been adapted to the industrial processes (ARIA 24856, 33472, 34007 and 36599). For the case of the Le Grand Quevilly accident, like that of Pardies (ARIA 34007), the tracking of damaged pressurised equipment was set up later, when regulatory measures became reinforced. The loss of technical specifications and this lack of a formalised monitoring programme over several decades had made it impossible to correctly identify the risks induced by processes performed on equipment (e.g. corrosion, fatigue, vibration), thus leading to a loss of substance confinement. This lack of knowledge can only be recovered by undertaking organisational and financial efforts of sizeable proportions with the added constraint of rapid implementation (involving production shutdown, preparation of equipment controls, removal of heat insulation). Along the same lines, experience has shown that the act of opening equipment can reveal serious internal defects not easily imagined previously (see the narrow miss at Reichstett (ARIA 21886)).

The most obvious anomaly is the absence of any formalised monitoring strategy (ARIA 17815), on some occasions with blatant disregard of current regulations, such as at the same site where two accidents occurred within 2 months of one another (ARIA 38650 and 39526), on a pressurised pipeline carrying overheated water vapour that had never been inspected after some 40 years of operations. As demonstrated in the case of Richemont (**ARIA 38436**) however, it is more common that an accident occurs despite the existence of formalised equipment monitoring that nonetheless proves inappropriate, due to :

- the control technique adopted relative to the targeted defect (ARIA 36654, 35264);
- control protocols (ARIA, 5954, 27415);
- equipment operating characteristics, inducing a specific loading that justifies use of the adapted control procedures (ARIA 36599);
- frequency and location of controls (ARIA 14666, 20356, 21961, 22358, 32460, 33410 and 36599);
- an equipment layout that makes for difficult, or even impossible, direct access or visual inspection (ARIA 19538, 31718, 32347, 35402 and 38140), or soil conditions that heighten the risk of corrosion : presence of flint / cobble, high conductivity, stray currents (ARIA 2257, 23034 and 27937), location in a potential flood zone (ARIA 21233, 35293, 35402, 37681 and **38436**), or in a landslide zone (ARIA 17379, **38436** and 39803);
- the physicochemical environment of the equipment, e.g.: a corrosive medium (ARIA 19922, 19538, 22751, 27415, 33077, 36578, 36599 and 38552), including galvanic corrosion (ARIA 23898) ; high relative humidity (ARIA 23252, 25990, 32347 and 35286) ; pipeline supports (ARIA 33071 and 39714) ; vibrations (ARIA 2680 and 33428) ; thermal shocks and loadings (ARIA 22249) ; risk of liquid leak from a nearby pipeline (ARIA 34351) ; or condensation originating from a refrigerated pipeline passing along the same alignment (ARIA 35146 and 38140).

On a more exceptional basis, accidents may arise from a diagnostic error that leads to an inappropriate monitoring programme (ARIA 35293), or perhaps to falsified procedural documents (ARIA 5954).

The accident at Le Grand Quevilly attests to a second organisational error, which reflects that equipment monitoring should not be limited to the diagnostic stage, but instead include the actual completion of the recommended preventive or remedial actions. If, as requested by the Inspection team already in place for 9 months, the "degradation by vibration" mode had been incorporated into the inspection routine for the damaged pipe, then an additional opportunity would have been provided to examine this high-pressure vapour piping situation with a convex base support and then to perhaps ultimately detect the steel noncompliance or the onset of corrosion on the weld. This deficiency or delay in applying the recommendations resulting from the control campaign can be found in several of the accident causes (ARIA 34007, 34351, 34990, 35293, 38140 and 39803).

The equipment monitoring and control steps implemented would need to be scaled to the magnitude of the various accident scenarios; such considerations are defined by the criteria of toxicity, energy potential, possible domino effects and the presence of vulnerable human and/or environmental elements. The measures adopted by a site operator subsequent to a repetition of similar accidents at the same site (ARIA 35146) demonstrate the pertinence of this approach. On the other hand, the accident at Le Grand Quevilly (**ARIA 38831**) suggests that focusing on the toxic risks engendered by NH₃ pipelines probably led to complacency regarding the hazards associated with the energy potential of pressurised vapour (which is a nontoxic product), as well as with possible domino effects on the site's other installations (i.e. pressurised NH₃ tanks, ammonium nitrate storage).

Accidents whose ARIA number has not been underlined are described on the Website :

www.aria.developpement-durable.gouv.fr

ARIA 2680 - IC – 06/03/1991 - 76 - GRAND-COURONNE





GRANDE PAROISSE

20.15 - Manufacturing of nitrogenous products and fertilisers

A liquid sulphur leak occurred on a 14,900-tonne capacity tank containing 11,000 tonnes of product kept hot at a temperature of 155°-160°C. The leak was flowing at a rate of 8.5 m³/hr (350 tonnes/day) through a hole between 1 and 2 cm in diameter at the base of the shell. The crack was caused by the rupture of internal anchorage points on the tank supply pipe originating inside the production units. Vibrations emitted during material transfer operations (600 m³/hr) gave rise to tensions acting on a weld of one of the reheating pipes, which broke allowing vapour to leak. This rupture induced erosion over a previously corroded zone, thus leading to perforation of the tank wall. Drainage required 6-8 days via transfer to various consumption units. The sulphur was channelled to a former parking lot for subsequent recovery by means of grinding after cooling. No external consequences were reported.

ARIA 5954 – 19/10/1994 - GERMANY - BONN





35.30 - Production and distribution of vapour and air conditioning

     A explosion occurred within an urban heating facility, at the time of performing recalibration operations. Four plant employees plus a subcontracted staff member died on the spot ; 2 others succumbed 2 and 5 days later, while another employee suffered serious burns. The explosion, caused by the rupture of a pipe containing overheated vapour at 550°C, was not responsible for any consequences beyond installation boundaries. Nine days before the accident, a certified inspection body had performed a

repeat test on this specific part of the circuit at a pressure below that specified in the testing protocol, and this certification would have apparently been forged. The unit involved, placed into service in 1982, was equipped with a capacity of 492 tonnes/hr.

ARIA 17815 – 26/05/2000 - 88 - LE THILLOT

15.11 - Seasoning and tanning of hides; preparation and staining of furs

     A leak occurred on the lower drainage pipe of a 16-m³ tank containing 10.3 m³ of sulphuric acid. The tank operating under 2 bar of pressure was feeding a tanning workshop. Further downstream, plant effluent was neutralised using lime milk and then treated with ferrous sulphate (i.e. sulphide precipitate) ; this effluent emptied into the site's settling basin before reaching a collective biological treatment plant.

At 5 am, workers observed the presence of product in the retention basin. At 6:15 am, the head of maintenance, in recognising the inability to bring the leak under control, notified the plant director and turned off the tank pressure surge. Leaving open the retention drainage system caused the massive intake of a highly acidic effluent in the municipal stormwater treatment plant at 7:30 am. The settling basin pump was then shut down and the drainage device closed. The operator proceeded by pouring the acid still present in the tank into 3,000-litre containers. Around 8 am, cracks on the retention basin filled with 7,300 litres of product began to cause leaks. Some 500 litres polluted the COUARD stream, which crosses the site, over a 400-m section and then reached the MOSELLE River over a 500-m stretch, resulting in the death of a large fish population. A fish farm was also contaminated by the leak. The operator channelled 6,000 litres of acid into the settling pond (since operations were being threatened at the municipal treatment plant) and then notified the fire station, town hall and 15 minutes later the local Prefect's office. In conjunction with this step, the operator neutralised the 800 litres of acid still present inside the basin by introducing sodium carbonate (soda ash). Upon arriving at the scene, the fire-fighting crew installed a sand dyke upstream of the watercourse. Around 2:30 pm, a specialised firm was called to the site to pump basin contents, which were then rinsed with water. Three hours later, an emergency prefectural order prohibited the operator from discharging any hazardous substances into the biological treatment plant intake. Backed by a specialist subcontractor, the operator on May 29th introduced a pH neutralisation and control system for settling pond effluents prior to treatment plant discharge. This modification helped bring the situation at the site back to normal as of June 2nd. Several anomalies were observed as regards the Prefect's ordinances: a cracked retention basin, failure to complete periodic inspections, and a noncompliant lower drainage pipe. This pipe had consistently been carrying a load and could not be sealed by installing an internal plug. The operator kept the basin offline, given its oversized dimensions relative to the unit's needs, preferring instead to use two 1,000-liter containers on a retention set-up in the tanning shop.

ARIA 21886 – 01/02/1999 - 67 - REICHSTETT

19.20 - Oil refining

At a refinery, works were initiated to install a series of bottom valves on spherical liquefied petroleum gas (LPG) storage tanks, which had been operating for several tens of years and deliberately emptied for these works. The valves were positioned upstream of the point where gas is drawn from the tank into the supply pipelines (DN 250, Pbutane = 5 bar, Ppropane = 13.7 bar), which for this occasion were disconnected. The pipe cut on one of the spherical tanks, downstream of the designated valve installation location, made it possible to detect a zone of very limited residual thickness. In this particular zone, pipe wall thickness was found to be roughly 2 to 3 mm for a nominal thickness of 12.7 mm, i.e. equal to a thickness loss of over 70%. The cut in the off-take pipe of a second tank allowed identifying the same type of defect. These two defects, both 13 cm long by 3 cm wide, were located immediately downstream of the elbow along the tank base and upstream of the first stop valve. The defect had been overlooked by the company's in-house inspection unit. The operator proceeded by controlling all of the site's off-take pipes and initiated a five-year inspection interval for these lines.

The implementation of bottom valves by the operator (featuring hydraulically-controlled safety valves) served to satisfy requests repeatedly submitted over the past few years by the Classified Facilities Inspectorate (installation of a positive safety valve or tap, in accordance with Article 8 of the May 10th, 1993 Ministerial decree).

The defects detected did not seem to be of a metallurgical origin, as no modification appeared at the bottom of the opening. Corrosion due to cavitation was also eliminated as a cause given both the pipe diameter and flow velocity (between 0.3 and 1 m/s). Moreover, defects were observed in an elbow section on tubes with different metallurgical compositions. The operator oriented his search towards erosion problems tied to the in-house operation of tank sand blasting, since the technician would have been capable of temporarily securing the sand-blast lance in the tank bottom when carrying out this task.

Due to the potential seriousness of the defects recorded, a national inspection campaign was launched on all installations of this type (see March 19th, 1999 Ministerial order) ; this same defect turned up on an LPG spherical tank at another French refinery.

ARIA 23034 – 20/2002 - 69 - FEYZIN*19.20 - Oil refining*

A flow of crude oil was observed at the periphery of a pipeline located inside the refinery. This pipeline was being supplied with crude oil by 2 feeder pipes of 10" and 16" diameter, which ran above-ground throughout the site and, as such, were categorised as internal plant pipes. Cathodic protection was no longer being provided to this zone. The pipelines passed underneath one of the site's pathways and were protected against external corrosion by applying a pitch. When crude was discovered near this pathway, an excavation was dug nearby to drain the zone and inspect a section of the 16" pipe lying underground at this spot: once the pitch protection had been removed, corrosion (pinhole sunk to a depth of 5.5 mm) could be observed adjacent to the perforated zone. According to the operator, this situation was caused by the absence of a protective bed of sand around the pipeline: rollers were placed in direct contact with the pipe wall and punctured the pitch protection. Repairs were performed by installing watertight collars on the most heavily damaged zone and then recomposing the pitch protection. The refinery had studied the feasibility of replacing the two pipelines by a single pipe and routing them into a concrete box under the street.

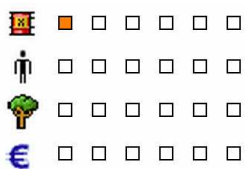
ARIA 27415 – 14/06/2004 - 22 - UZEL
46.71 - Wholesale of fuels and auxiliary products

During a routine inspection of a spherical 2,000-m³ propane tank (previous test date: 2002) located in an LPG depot, the facility manager heard a whistling sound caused by a leak. The origin was a 1" tube positioned 2.50 m from the top of the tank and used to feed a gauge device that at the time had been dismantled. Another tube connected with the first one was also serving no function. The gas detectors did not show any extraordinary readings ; moreover, the tank level indicators did not reveal

any visible variations. A walk-through inspection the day before at the top of the tank did not suggest anything abnormal. The tank was holding 830 tonnes of propane when the event took place.

The leak, which occurred less than 22 months after the most recent ten-year test, was due to an external 3-mm perforation resulting from a water retention point opening that triggered a differential aeration mechanism with local acidification, otherwise known under the name "EVANS drop". The repair work, which entailed removal of the 2 redundant tubes, required draining the spherical tank, installing scaffolding and then inspecting welds once the tubes had been dismantled and the surfaces smoothed and levelled. While waiting for this sequence of repairs, the operator plugged the crack with a resin and inserted reinforcement collars. Two tests were conducted daily on this temporary repair job using a leak detection product. The tank was subsequently drained and degassed at the end of July. A subcontractor executed these repairs during the second half of August. The suspected faulty tube was submitted for expert appraisal.

ARIA 33071 – 03/06/2007 - 76 - NOTRE-DAME-DE-GRAVENCHON
19.20 - Oil refining

Around 5:10 pm, an explosion followed by a fire rocked a fuel oil desulphurisation unit at a refinery. The internal emergency plan was activated, a safety perimeter set up around the unit and a departmental highway was temporarily closed to traffic.

A response team had the main fire under control within about 50 min without requiring assistance from external emergency services, which nonetheless were at the scene for preventive purposes. The internal emergency plan was lifted at 10:35 pm.

This unit was shut down at the time for scheduled cleaning of a cooling tower with reintroduction of a gas into the system at a high H₂ content. The accident was caused by the complete rupture of an 8" heat-insulated carbon steel pipeline located along an upper rack and fed by a hydrocarbon/hydrogen mix. The accident triggered an explosion whose pressure surge was evaluated by the site operator at approx. 60 mbar at a distance of 10 m. Since the leak was being fuelled, the fire affected other pipelines as well as the exhaust valves connected to the flare system, which explains the persistence of several secondary fire outbreaks, finally extinguished around 3:30 am. The quantities released were estimated by the operator to be less than 2 tonnes of liquid hydrocarbons and 50 kg of hydrogen.

No victims were reported. The economic consequences were appraised at €500,000 of property damage and €2 million in production losses.

A prefectural order imposing emergency measures required the operator to conduct investigations in order to determine accident causes and establish the conditions for restarting service at the damaged unit. This rupture was due to external corrosion localised on the pipeline supporting structure. Over a section approx. 45 cm long on the line's lower half-circumference, the residual pipeline thickness equalled 3 mm on average vs. 6.5 mm originally, and eventually reached 1.2 mm in certain zones. The rupture occurred in two stages: an initial break, followed by propagation of the opening as a result of the high pressure of gases circulating inside the pipeline.

Afterwards, the operator revised the risk assessment for the operational gas lines capable of corroding either under the heat insulation or at the supporting points, where the prospect of a pipe burst had to be taken into account under certain conditions, i.e.: service pressure above 25 bar ; gaseous or mixed state when operating ; diameter exceeding 2"; and a hazardous fluid being transported (H₂, C₂, C₃, H₂+H₂S). The operator also ensured the adequate implementation procedures and good state of heat insulation ; a special examination was also carried out on pipes not being stored on skids.

Moreover, the operator issued a press release.



ARIA 34007 – 17/12/2007 - 64 - PARDIES
20.15 - Manufacturing of nitrogenous products and fertilisers

Around 8:20 am, a sustained leak occurred on a pipeline located downstream of the reactors within a nitric acid production unit at a plant specialised in basic chemical products. The tripping of safety relays shut down the shop. An orange cloud of nitrous gas was released into the atmosphere for roughly 30 seconds. Onsite fire-fighters installed water curtains at the level of the leak and conducted a number of toxicity measurements in the wind, all of which turned out to be negative. No one was injured or hurt and no production facilities were damaged ; the operator issued a press release.

The investigation conducted by the site operator indicated that the leak occurred at the spot of a longitudinal weld to place a tap (DN 700, P=2.7 bar, T=85°C, type 304 L carbon steel), at the outlet of one of the unit's nitrous gas / nitrous gas exchangers. The pipeline in question, built in 1991, was originally used by another Group plant that had since closed. After a 3-year idle period, this infrastructure was assembled on the given unit in 1994, with an increased diameter (from 500 to 700 mm) in order to limit head loss. By being waived of regulations relative to pressurised equipment (i.e. P<4 bar), the incident was not recorded (neither materials certificates nor specifications). Since this regulation changed in 2000, the equipment had to be recertified in 2004, although no construction or modification application was filed. A metallurgical appraisal of the tapping opening revealed that while the material was compliant, an acidic (intergranular) corrosion had developed at the site of the longitudinal welds performed using 2 rolled and welded metal sheets. The corrosion caused a significant loss of thickness in the thermally affected

zones (TAZ) of these metal sheets: 0.4 mm residual vs. 2 mm originally. Excessive heat energy was used for the lateral welds during tap diameter modification. A precipitate of chromium carbides could also be observed outside these TAZ zones, which is characteristic of incomplete heat treatment of the sheet metal introduced. These two metallurgical processing errors caused a local decrease in the steel's chromium content, with the steel becoming more sensitive to intergranular corrosion by means of nitric acid condensation during transient phases. This corrosion wound up causing complete rupture of the pressurised tap adjacent to one of the welds. The loss of thickness at the point of the weld had already been detected in 2006 but only gave rise to a specific monitoring of the pipe ; the next inspection was scheduled for 2008.

The operator also verified the thickness of other equipment along the unit's pipe path, particularly longitudinal welds within the TAZ zones, yet no loss of thickness was recorded. The pipe inspection programme was enhanced and thereafter included a periodic thickness verification of TAZ zones containing longitudinal welds. Feedback on this accident was applied to the Group's other plants by recognising this mode of equipment degradation.

 □ □ □ □ □ □ **ARIA 34351 - 16/03/2008 - 44 – DONGES**

19.20 - Oil refining

 □ □ □ □ □ □ While loading 31,000 m3 of bunker fuel in a ship, a leak in a refinery transfer hose resulted in a major oil spill in the Loire estuary. At 4.10 pm, a person on a barge observed the presence of hydrocarbons on the water surface and sounded the alert. At around 4.45 pm, a roundsman identified and isolated the leak at

 ■ ■ ■ ■ ■ □ 500 m upstream to where the hydrocarbons were detected. The internal contingency plan was triggered at 5.00 pm and the inspection authorities of classified facilities were informed. A recovery ship was stationed at the mouth of the river while two trawlers recovered hydrocarbon pellets from the river. The public ban on access to several beaches and fishing in the river that was in place subsequent to the spill was gradually lifted between the 4 and 18 of April. Over 750 people were involved for three and a half months in cleaning up the 90 km of polluted banks (6,170 tonnes of waste recovered and stored onsite before disposal). The operator bore the cost of 50 M euros to cover for the damage incurred, clean up and compensate effected businesses.

Investigations revealed that the leak was detected only after 5 hours leading to 478 tonnes of fuel being spilled of which 180 tonnes flowed into the Loire estuary. A 16 cm² longitudinal breach caused by corrosion localised under the insulator was observed upon examination of the hose. The corrosion resulted from a water leak in the vertical pipe. Water seeped beneath the insulator, caused corrosion and subsequently caused the fuel pipe to rupture. Despite several defects detected the previous month on the same rack, the operator failed to revise this inspection programme to take into account the specific risks presented by this line given its proximity with the river banks. The effected fuel line was completely stopped and the inspections on the entire rack revealed several corrosion points on other lines that required repair. The operator was required to implement several additional initiatives and measures :

- Extending inspection operations to other pipes in the site along with measurement of thickness at sensitive points (supports, spurs, etc.)
- Moving the layout of the service water mark so that it is not in a vertical position with respect to the insulated pipe
- Using a leak detection system along with a remote alarm in the control room to constantly monitor pipes located near the river - Modifying the ground below the rack to channel any accidental spill to an adapted recovery network
- Installing a device to monitor the quantity of products leaving the tank and entering the corresponding transfer hose It was also planned to consolidate the available emergency measures in the event of accidental pollution of the Loire river.

 ■ ■ □ □ □ □ **ARIA 35146 – 06/09/2008 - 76 - NOTRE-DAME-DE-GRAVENCHON**

20.11 - Production of industrial gases

 □ □ □ □ □ □ Around 1:25 pm, a technician noticed a strong gas smell he could identify as propylene along with the presence of a fog cloud in the middle of the steam cracker, yet without being able to precisely locate the leak's source. He returned to the control room and sounded the alarm. Detection alarms on several explosimeters within the zone lit up on the safety control panel; the control panel operator called the fire







 □ □ □ □ □ □ safety team at 1:28 pm and activated the internal emergency plan at 1:33. Technicians working outside were evacuated and the site's sprinkling systems were sequentially turned on between 1:28 and 2:20 pm in order to create a water screen around the gas cloud and cool potential flash points. Classified Facilities Inspection authorities were informed of the incident via the alarm relay around 2:30 pm.







Some 15 minutes later, a vertical gaseous spray was observed in a cluster of above-ground pipes situated approx. 8 m off the floor. About 3:35 pm, an opening could be identified on a liquefied butane pipe made of carbon steel, 4" (101.6 mm) in diameter, 500 m long and operating at a pressure of 18 to 20 bar. At 3:40 pm, depressurisation of the line's contents towards the flare system began; shortly before 3:50 pm, the circuit was isolated and the leak reduced in magnitude. The emergency plan was lifted at 4 pm, and the operator proceeded by issuing a press release. This leak incident was estimated to have lasted slightly less than 2½ hours; according to the operator, gas concentration only reached 20% of the lower flammable limit. At the time of this event, the line in question had been filled with liquefied gas yet isolated at its ends by valves placed in the closed position. The tube burst due to thermal expansion of the liquid at a pressure below the set pressure of the exhaust valve installed on the line (48 bar relative pressure). The steam cracker was kept running for a few days until its scheduled shutdown for 6 weeks. An examination of the suspected piping revealed an opening on the upper generator along a so-called "fish mouth" longitudinal path extending approx. 50 mm long by 20 mm wide (equivalent diameter of approx. 30 mm), with a considerable loss of thickness in the rupture zone. The piping, which had no heat insulation, also displayed a general external corrosion over the entire cross-section.







The cluster containing the defective pipes lay directly underneath another rack, where a refrigerated ethylene pipeline was running. Highly-localised external corrosion had been exacerbated by the drops originating from melting ice enveloping the outer surface of the refrigerated ethylene pipe above the defective pipe.







The investigations conducted by the Classified Facilities Inspectorate would confirm the good working order of gas detection sensors, which responded sequentially between 1:28 and 1:30 pm, starting from the sensor positioned closest to the leak and continuing to the furthest sensor. From a regulatory standpoint, the operator indicated that the pipeline was exempt from periodic recertification procedures, simply requiring a periodic inspection; moreover, this inspection had been scheduled for 2009. A visual assessment of the damaged pipe section 14 months prior had not detected even the slightest trace of corrosion. Several accidents caused by corrosion underneath heat insulation had already occurred at the site; the operator implemented an inspection plan adapted to the likelihood and consequences of external pipeline degradation, including :

- A control protocol for all pipes containing inflammable, toxic or corrosive products was adopted (supplemental visual inspection and non-destructive control) ;
- Detailed pipe inspection practices were extended, extending to the pipe structures (i.e. racks) ;
- Quick detection and treatment of specific aggressions affecting the facilities was emphasised ;
- A quality assurance process dedicated to the pipe lining was designed (paint, heat insulation, fire retardant, coolant) in order to provide a minimum application standard.

      **ARIA 35264 – 27/07/2008 - 39 - TAVAUX**







      *20.13 - Manufacturing of other basic inorganic chemical products*







      At a plastics plant, a nitrogen injection pipe broke at the level of a pyrolysis oven (dichloroethane supply for producing vinyl chloride). Technicians quickly intervened to shut down the dichloroethane supply line to the oven, yet a loud noise persisted.

      The downstream valves were closed and the sprinkling system activated, making it possible to confine the leak to oven contents, which after draining amounted to 2,062 kg of dichloroethane, 41 kg of CVM and 23 kg of HCl. The background detection networks only signalled this leak as the incident was unfolding, once the wind had changed direction.

This pipe rupture was due to internal corrosion of the nitrogen injection pipeline, as a likely consequence of acidic condensation adjacent to the oven wall due to a lack of heat insulation. This incident called into question background detection networks, which under certain wind conditions had become inoperable; doubts were also raised regarding pipe thickness controls by ultrasound.







      **ARIA 35293 - 16/10/2008 - 64 – LACQ**

      *20.14 Manufacture of other basic organic chemicals*







      At around 4.00 pm, an employee in a chemical plant detected a hydrogen sulphide (H₂S) leak from a transport pipe (NPS 50, pressure 5 bars) in a four-cable walkway. Upon receiving the alert, the operator decreased the pressure in the pipeline, opened the automatic sectional valves and informed the emergency services. However, the surveillance and contingency plan relating to the structure was not







triggered. Once the fire-fighters arrived, a fire extinguisher nozzle was implemented to neutralise the hydrogen sulphide vapours, a safety perimeter was established and the gas concentrations were measured. The accredited inspection department of the chemical facility arrived onsite at around 4.30 pm. The leaking transport pipe was isolated using metal plates and at around 6.30 pm a collar was fitted to seal the pipe. The entire structure was inerted using nitrogen at around 7.00 pm. The operating company planned to submit a repair proposal to the inspection authorities for classified facilities. The operator immediately drafted a press release after the incident.

No casualties or environmental impact were reported. Differential aeration corrosion of the structure may have been the cause of the incident. The corrosion area was localised in a lower generator, at about 20 cm after the point where the pipeline resurfaced from the ground where the coal-tar pitch coating passively protecting the part of the pipeline below the ground is no longer present. Further to the investigation carried out by inspection authorities for classified facilities, it was found that the use of a general anti-oxidant treatment of the pipe was recommended to the operator. A malfunctioning in the cathodic protection was also brought to his notice. Errors in interpreting the images by the company that carried out the non destructive X-ray inspection were also observed. Lastly, the drop in the pipeline pressure failed to trigger the safety alarms provided for in the site's safety study. The inspection authorities concluded that the detection systems were ineffective given the low leak volume and that the alert was sounded only due to the adventitious presence of an employee.

      **ARIA 36599 – 03/09/2003 - BELGIUM - ANTWERP**

      *19.20 - Oil refining*

      A fire broke out at 8:15 pm in a vacuum distillation unit at a refinery. Internal and external first responders had the blaze under control within 90 minutes. Two slight injuries were reported : a technician suffered first-degree burns and a fire-fighter sprained his ankle, but both were able to return to work the same day.







      The environmental impact was limited to a black, non-toxic smoke cloud. Property damage was considerable, and the unit had to be shut down an estimated 3 months to allow for inspections and repair work.







This fire resulted from an ignited leak of slop wax (a paraffin residue) subsequent to an opening of approx. 40 cm² (10 cm*4 cm) on the 3" line for recycling this product into the vacuum distillation unit load. The slop wax drawn from the riser at 370°C, which is higher than its self-ignition temperature (220°-300°C), instantaneously combusted when placed in contact with air.

Several causes acting together were responsible for this accident. For starters, the presence of sulphur in the slop wax (0.7%-1.4% S) and the racking at 370°C generated a high-temperature sulphurous type of corrosion that in turn produced a loss of pipeline thickness on the order of 1 to 2 mm. Moreover, the targeted portion of the circuit had been added during a facility modification performed in 1988, which was intended to inject slop wax into the unit load : this modification used 3" carbon steel, a material that was not adapted to either the temperature conditions or the product composition. The defective pipeline was not included in the "slop wax" inspection programme, but instead as part of the programme dedicated to the load circuit, which is less vulnerable to corrosion. Since 1988 therefore, the thickness of this part of the circuit had been less frequently inspected than that of the "slop wax" circuit. The operator commented that during the fire outbreak, 3 automated sectional valves out of the 7 were not working properly and had remained open or partially open. Also, some electric pumps and turbines that had not been equipped with remote controls could not be shut down when the fire first broke out.

Following this accident, the operator revised the site's inspection schedules, particularly for pipelines whose service temperatures exceeded the product self-ignition temperatures. An audit and update were ordered of the plant's inspection plans to ensure compliance with a stricter set of criteria. The operator sought to verify that all previous modifications had been taken into account in the updated inspection plans and moreover that modification procedures addressed corrosion at the level of specification change zones. A systematic alarm and safety testing protocol at regular intervals was adopted in addition to checking that the shutdown controls for all rotating machinery were accessible remotely. As a final consideration, the operator introduced an adequate and continuous training programme on incident handling strategies for operating personnel.

      **ARIA 38140 – 15/02/2010 - 76 - GONFREVILLE-L'ORCHER**

      *20.14 - Manufacturing of other basic organic chemical products*

      A hydrogen leak occurred at a chemical plant around 1 am on a pipeline inside a steam cracking unit located between the C2 and C3 hydrogenation installations. The gaseous mix transported through this 2" pipe (at 30 bar, 40°C) was composed of 95% hydrogen, 4% methane and 1% nitrogen. The pipe ran in a rack within the cold sector, at a height of 6 m. The personnel shut down the steam cracker before repairing the pipeline ; they isolated the sector and the C2 and C3 cuts were sent to the flare system. The leak was successfully sealed at noon, and the steam cracker remained down for a full 24 hours.

Runoff due to water vapour condensation was observed on a cold pipe located above the perforated piping assembly. This drop-by-drop action had weakened the pipeline, causing corrosion and thinning of the upper surface. The perforation had resulted from a pressure shock introduced during the process. The Classified Facilities inspection authorities noted that the

pipeline had not been protected against corrosion by a coat of paint. This pipe section, despite being monitored by an accredited inspection body focusing on individual problem areas, had been repainted in 1990 and then verified in both 2000 and 2007. During the 2007 inspection, it had been commented that the particular section was inaccessible due to the expansion layer formed by corrosion/erosion and therefore could not be controlled. The 2007 investigations did not allow for measuring the magnitude of corrosion, and no specific guideline was issued for the restoration of this section (painting work at the very least). The inspectors also noticed runoff on the pipe racks through this zone, along with a major degradation of pipe paint, which in some cases had totally disappeared.

ARIA 39526 – 15/07/2010 - 40 - TARTAS

17.11 - Paper pulp manufacturing

In a paper mill requiring regulatory authorisation, a leak was detected on a pipe within the vapour network. The shutdown procedure targeting the boiler producing the vapour was activated. The pipe, operated at a pressure of 80 bar, connected the boiler outlet to a distribution barrel. The leak was located upstream of the barrel, at the level of the tie-in weld of a valve bypass tap. The barrel was stored in a seldom used utility room and the pipe's heat insulation contained the leak, which therefore posed no hazard relative to individual safety.

Installation piping was composed of alloy steel with a grade of 13CrMo4 and a DN 175 specification; it was designed for a maximum allowable pressure of 110 bar. The tap served to balance pressure upstream and downstream of a 60-mm diameter valve. The leak had originated from mechanical and thermal fatigue cracking, caused by the high number of boiler start/stop cycles. The operator performed the tap repair by changing a 20-cm spool, in addition to modifying the boiler start-up procedure in order to limit both dilatation stresses around the bypass and pressure surges, by allowing for a very gradual division of this component. The pipe had not been inspected since its initial service start-up in 1970 ; hence the operator was motivated to implement a periodic inspection programme, in accordance with regulations specific to pressurised equipment.

 □ □ □ □ □ □ **ARIA 39803 – 05/06/2010 - 77 - GRANDPUITS-BAILLY-CARROIS**

19.20 - Oil refining

 □ □ □ □ □ □ During his rounds at around 4 pm, a refinery technician detected a crude oil leak in the area of a pipe within a cluster connected to a crude storage tank. The operator placed a 2-m platinum plating in the leaky zone and called on a subcontractor to pump the crude oil released into the ground over a 200-m² surface area. It was estimated that the leak lasted 2 hours, given that the morning inspection did not reveal anything and that the volume released amounted to 200 m³. The polluted ground was excavated manually and then sent for disposal to a certified processing centre, while 15 m³ of crude oil were pumped on the day of the accident.

 ■ □ □ □ □ □ External corrosion on a pipe elbow emanating from the pressure release exhaust valve on a crude oil tank was responsible for this leak, which moreover was fed by the hydrostatic pressure of crude contained in the tank. The elbow was placed half underground in a sandy soil due to erosion of a nearby embankment slope. The above-ground clusters of refinery pipes had not been maintained for a number of years in order to reduce costs, and this situation led to the partial burial of some sections due to gradual soil subsidence. Soil humidity most likely accelerated the external corrosion phenomenon in the leaking elbow. The operator had introduced a 3-year pipe cluster renovation plan (sand removal and visual verification), but the plan had yet to be implemented on the compromised pipe, which had not received any cathodic protection. The Classified Facilities inspectors requested the operator to complete, as quickly as possible, the inspection of above-ground pipe clusters subjected to ground subsidence and then replace those displaying any risk of leaking.

European scale of industrial accidents

Graphic presentation used in France

This scale was made official in 1994 by the Committee of Competent Authorities of the member States which oversees the application of the Seveso directive. It is based on 18 technical parameters designed to objectively characterise the effects or consequences of accidents: each of these 18 parameters include 6 levels. The highest level determines the accident's index.

Further to difficulties which stemmed from the attribution of an overall index covering the consequences that are completely different according to the accidents, a new presentation of the European scale of industrial accidents with four indices was proposed. After having completed a large consultation of the various parties concerned in 2003, this proposal was retained by the Higher Council for Registered Installations. It includes the 18 parameters of the European scale in four uniform groups of effects or consequences:

- 2 parameters concern the quantities of dangerous materials involved,
- 7 parameters bear on the human and social aspects,
- 5 concern the environmental consequences,
- 4 refer to the economical aspects.

This presentation modifies neither the parameters nor the rating rules of the European scale.

The graphic charter:





































The graphic charter adopted for the presentation of the 4 indices is as follows:

Dangerous materials released							
Human and social consequences							
Environmental consequences							
Economic consequences							

When the indices are yet explained elsewhere in the text, a simplified presentation, without the wordings, can be used:

						
						
						
						

The parameters of the European scale:

 Dangerous material released		1	2	3	4	5	6
		     	     	     	     	     	     
Q1	Quantity Q of substance actually lost or released in relation to the « Seveso » threshold *	$Q < 0,1 \%$	$0,1 \% \leq Q < 1 \%$	$1 \% \leq Q < 10 \%$	$10 \% \leq Q < 100 \%$	De 1 à 10 fois le seuil	≥ 10 fois le seuil
Q2	Quantity Q of explosive substance having actually participated in the explosion (equivalent in TNT)	$Q < 0,1 \text{ t}$	$0,1 \text{ t} \leq Q < 1 \text{ t}$	$1 \text{ t} \leq Q < 5 \text{ t}$	$5 \text{ t} \leq Q < 50 \text{ t}$	$50 \text{ t} \leq Q < 500 \text{ t}$	$Q \geq 500 \text{ t}$

* Use the higher "Seveso" thresholds. If more than one substance are involved, the higher level should be adopted.

 Human and social consequences		1	2	3	4	5	6
		■□□□□□	■□□□□□	■□□□□□	■□□□□□	■□□□□□	■□□□□□
H3	Total number of death: including - employees - external rescue personnel - persons from the public	- - - -	1 1 - -	2 – 5 2 – 5 1 -	6 – 19 6 – 19 2 – 5 1	20 – 49 20 – 49 6 – 19 2 – 5	≥ 50 ≥ 50 ≥ 20 ≥ 6
H4	Total number of injured with hospitalisation ≥ 24 h: including - employees - external rescue personnel - persons from the public	1 1 - -	2 – 5 2 – 5 - -	6 – 19 6 – 19 1 – 5 -	20 – 49 20 – 49 6 – 19 -	50 – 199 50 – 199 20 – 49 20 – 49	≥ 200 ≥ 200 ≥ 200 ≥ 50
H5	Total number of slightly injured cared for on site with hospitalisation < 24 h : including - employees - external rescue personnel - persons from the public	1 – 5 1 – 5 - -	6 – 19 6 – 19 1 – 5 -	20 – 49 20 – 49 20 – 49 6 – 19	50 – 199 50 – 199 50 – 199 20 – 49	200 – 999 200 – 999 200 – 999 50 – 199	≥ 1000 ≥ 1000 ≥ 1000 ≥ 200
H6	Total number of homeless or unable to work (outbuildings and work tools damaged)	-	1 – 5	6 – 19	20 – 99	100 – 499	≥ 500
H7	Number N of residents evacuated or confined in their home > 2 hours x nbr of hours (persons x hours)	-	N < 500	500 ≤ N < 5 000	5 000 ≤ N < 50 000	50 000 ≤ N < 500 000	N ≥ 500 000
H8	Number N of persons without drinking water, electricity, gas, telephone, public transports > 2 hours x nbr of hours (persons x hours)	-	N < 1 000	1 000 ≤ N < 10 000	10 000 ≤ N < 100 000	100 000 ≤ N < 1 million	N ≥ 1 million
H9	Number N of persons having undergone extended medical supervision (≥ 3 months after the accident)	-	N < 10	10 ≤ N < 50	50 ≤ N < 200	200 ≤ N < 1 000	N ≥ 1 000

 Environmental consequences		1	2	3	4	5	6
		■□□□□□	■□□□□□	■□□□□□	■□□□□□	■□□□□□	■□□□□□
Env10	Quantity of wild animals killed, injured or rendered unfit for human consumption (t)	Q < 0,1	0,1 ≤ Q < 1	1 ≤ Q < 10	10 ≤ Q < 50	50 ≤ Q < 200	Q ≥ 200
Env11	Proportion P of rare or protected animal or vegetal species destroyed (or eliminated by biotope damage) in the zone of the accident	P < 0,1 %	0,1% ≤ P < 0,5%	0,5 % ≤ P < 2 %	2 % ≤ P < 10 %	10 % ≤ P < 50 %	P ≥ 50 %
Env12	Volume V of water polluted (in m ³) *	V < 1000	1000 ≤ V < 10 000	10 000 ≤ V < 0.1	0.1 Million ≤ V < 1 Million	1 Million ≤ V < 10 Million	V ≥ 10 Million
Env13	Surface area S of soil or underground water surface requiring cleaning or specific decontamination (in ha)	0,1 ≤ S < 0,5	0,5 ≤ S < 2	2 ≤ S < 10	10 ≤ S < 50	50 ≤ S < 200	S ≥ 200
Env14	Length L of water channel requiring cleaning or specific decontamination (in km)	0,1 ≤ L < 0,5	0,5 ≤ L < 2	2 ≤ L < 10	10 ≤ L < 50	50 ≤ L < 200	L ≥ 200

* The volume is determined with the expression Q/C_{lim} where:

- ✓ Q is the quantity of substance released,
- ✓ C_{lim} is the maximal admissible concentration in the milieu concerned fixed by the European directives in effect.

 Economic consequences		1	2	3	4	5	6
		■□□□□□	■□□□□□	■□□□□□	■□□□□□	■□□□□□	■□□□□□
€15	Property damage in the establishment (C expressed in millions of € - Reference 93)	0,1 ≤ C < 0,5	0,5 ≤ C < 2	2 ≤ C < 10	10 ≤ C < 50	50 ≤ C < 200	C ≥ 200
€16	The establishment's production losses (C expressed in millions of € - Reference 93)	0,1 ≤ C < 0,5	0,5 ≤ C < 2	2 ≤ C < 10	10 ≤ C < 50	50 ≤ C < 200	C ≥ 200
€17	Property damage or production losses outside the establishment (C expressed in millions of € - Reference 93)	-	0,05 < C < 0,1	0,1 ≤ C < 0,5	0,5 ≤ C < 2	2 ≤ C < 10	C ≥ 10
€18	Cost of cleaning, decontamination, rehabilitation of the environment (C expressed in millions of € - Reference 93)	0,01 ≤ C < 0,05	0,05 ≤ C < 0,2	0,2 ≤ C < 1	1 ≤ C < 5	5 ≤ C < 20	C ≥ 20