

**IMPEL**

**DIFFUSE VOC EMISSIONS**

December 2000



**IMPEL  
NETWORK**

European Union Network for the Implementation  
and Enforcement of Environmental Law



# **IMPEL**

## **DIFFUSE VOC EMISSIONS**

- **emission estimation methods**
- **emission reduction measures**
- **licensing and enforcement practice**

**December 2000**

**IMPEL Project 15**

- **Project management: the Netherlands' Inspectorate for Environmental Protection**
- **Consultants: Tebodin assisted by Schelde Leak Repairs Specam and Cowi**

**Note**

The European Union Network for the Implementation and Enforcement of Environmental Law is an informal network of the environmental authorities of EU Member States. The European Commission is also a member of IMPEL and shares the chairmanship of management meetings.

The network is commonly known as the IMPEL Network

The expertise and experience of the participants within IMPEL make the network uniquely qualified to work on certain of the technical and regulatory aspects of EU environmental legislation. The Network's objective is to create the necessary impetus in the European Community to make progress on ensuring a more effective application of environmental legislation. It promotes the exchange of information and experience and the development of greater consistency of approach in the implementation, application and enforcement of environmental legislation, with special emphasis on Community environmental legislation. It provides a framework for policy makers, environmental inspectors and enforcement officers to exchange ideas, and encourages the development of enforcement structures and best practices.

Information on the IMPEL Network is also available through its web site at <http://europa.eu.int/comm/environment/impel>.

This report is the result of a project within the IMPEL Network. The content does not necessarily represent the view of the national administrations nor of the Commission. The report was adopted approved at the IMPEL Meeting of 6-8 December 2000.

**IMPEL secretariat**

Directorate General XI: Environment, Nuclear Safety and Civil Protection,  
BU-5, 4/146  
Rue de la Loi - Wetstraat 200,  
B-1049 Brussels,  
Tel.: +32 (2) 2992349  
Fax: +32 (2) 2991070

<b>Table of contents</b>		page
<b>Executive summary</b>		<b>5</b>
<b>1</b>	<b>Introduction</b>	<b>17</b>
1.1	Background	17
1.2	Objective	17
1.3	Scope and definitions	17
1.4	VOC emission sources	19
1.5	European VOC policy	21
1.6	Approach	21
<b>2</b>	<b>Emission estimation methods</b>	<b>23</b>
2.1	General	23
2.2	Equipment	23
2.3	Storage tanks, loading & unloading and utilities	29
2.4	Remote sensing and other leak detection methods	31
2.5	Practice in the EU member states	33
2.6	Evaluation of the methods	34
<b>3</b>	<b>Measures to reduce VOC emissions</b>	<b>39</b>
3.1	General emission reduction measures	39
3.2	Equipment	39
3.3	Storage tanks, loading&unloading and utilities	40
3.4	Practice in the EU member states	40
<b>4</b>	<b>Licensing and enforcement practice</b>	<b>43</b>
4.1	Licensing and enforcement in general	43
4.2	Practice in the EU member states and the USA	44
<b>5</b>	<b>Recommendations</b>	<b>49</b>
5.1	Introduction	49
5.2	Identification of industries with potential relevant emissions	49
5.3	Target or limit value	49
5.4	Procedural measures	50
5.5	Emission estimation	50
5.6	Technical measures	51
5.7	Non-compliance	51
5.8	Supporting activities	52
<b>Literature and web sites</b>		<b>53</b>
<b>Glossary and extract of IPPC Directive</b>		<b>58</b>

**Annex**

Annex A: Contact details.

Annex B: Low emission components and techniques.

Annex C: Example of diffuse emissions regulations.

Annex D: Proposal for an action plan for diffuse emissions control.

Annex E: Comparison of different emission estimation methods.

Annex F: European VOC emissions and reduction targets.

Annex G: Questionnaire.

Annex H: Extract of the first draft BREF notes on mineral oil refineries.

## **Executive summary**

### **I. Background**

Establishing an environmental policy for industrial sources usually commences with a regulation of the large point sources. Attention is then focused on piped emissions, e.g. exhaust gases directed via a stack and wastewater through a discharge pipe. In general these piped emissions are well regulated and have been reduced substantially, to such an extent that the other emissions have become more and more dominating. With respect to atmospheric emissions of volatile organic emissions (VOC) these 'other emissions' comprise mainly leakage from equipment (fugitive emissions) and evaporation losses of storage, loading and unloading. These emissions are called 'diffuse' emissions. Monitoring of diffuse emissions is more complex compared with monitoring of piped emission sources. Abatement and regulation of diffuse emissions is a relatively new issue in some member states of the European Union (EU). It is however not common practice in all EU member states, this contrary to the USA where it is common practice for about 10-20 years.

The main environmental effect of VOC in general is their role in the formation of smog and ozone in the presence of nitrogen oxides. VOC in the ambient air are precursors to the formation of ground level (tropospheric) ozone, the primary constituent of smog. Smog and ozone cause respiratory damage, damage to property and vegetation (agriculture and ecosystems). Individual components of VOC are known for other negative effects such as toxic effects on health and ozone layer depletion in the stratosphere. Reduction of VOC emissions is not only beneficiary to the environment but also can lead to better workplace conditions, can reduce risks of fire, can reduce nuisance (odours) and can save money.

IMPEL, the environmental inspectors network for the EU, has defined a project on diffuse emissions. The intention is to provide guidelines for implementing diffuse emissions regulations, both for licensing of industrial plants and for enforcement. The Netherlands' Inspectorate for the Environment is in charge of the project and commissioned Tebodin to assist as consultant.

### **II. Objective, scope and approach**

The objective of the project is to review the diffuse VOC emissions estimation methods and measures in the EU and to propose guidelines in order to improve the monitoring, licensing and inspection of industrial activities.

The project is focused on the VOC emissions of diffuse sources of large process installations, both fugitive emissions (leakage from equipment) and emissions from storage tanks and loading/unloading. The installations & emissions are common in refineries and (petro-) chemical plants. Excluded are emissions resulting from the use of solvents which are regulated by the Directive 1999/13/EC and the VOC emissions from petrolfillingstations regulated by the Directive 94/63/EC.

Although the targeted activities are restricted to the process industry it should be clear that various of the presented measuring methods, reduction techniques and licensing&enforcement practice are also applicable to other activities such as (off-shore) gas&oil exploration/production and military activities.

Some of the remote sensing methods are well suited for measuring the diffuse emissions of landfill sites (e.g. methane leakage).

The project commenced with a literature review. The review was completed by an EU wide inventory, executed in close co-operation with the members of the IMPEL working group. The findings were summarised in this document, which was discussed in two meetings of the Working Group.

### **III. European policy**

A significant VOC emission reduction in Europe is the objective of several protocols and policy plans. A brief overview of the (European) VOC reduction policy and targets is presented in annex F.

Permit requirements are subject of the IPPC Directive [96/61/EC]. The application of Best Available Techniques (BAT) is a cornerstone of the Directive and diffuse emissions are a subject that needs to be addressed in the environmental permit.

It is the intention of the European IPPC Bureau in Sevilla to develop BAT reference documents for about 30 industrial sectors and a few general subjects. Of interest are the sectors 'refineries', 'large volume organic chemicals' and 'storage' and the subject 'monitoring'. These sectors BAT reference documents are being prepared.

The Technical Working Group on monitoring will cover the monitoring of fugitive emissions. It is however not their intention to provide a BAT reference document as it is not intended to specify the best monitoring techniques but it is their intention to provide an exchange of views and practices [IPPC'99] to enhance the licensing.

### **IV. Emission estimation methods**

Estimation of diffuse emissions is more difficult and complex than estimating piped emissions (e.g. by stack measurement). A variety of methods have been developed. The methods range from calculation to measurement, point measuring to remote sensing. Some are suited for leak detection, others for estimation of the annual emission or both. The presented overview is focused on methods to identify leaks and methods to estimate the annual emission.

It should be realised that the guidelines of the United States Environmental Protection Agency (EPA) are widely used in the EU member states. Also the methods that are developed within a member state are often based on the EPA guidelines and the emission estimating equations that are developed by the American Petroleum Institute (API). Interesting emission estimation methods of EPA and API are referenced in the literature overview (chapter 6).



#### **IV.1 Equipment, storage tanks, loading & unloading and utilities**

The United States Environmental Protection Agency (EPA) issued the Protocol for Equipment Leak Emission Estimates [EPA'95]. According to this protocol, different approaches can be used to estimate emissions. These approaches are, in order of increasing refinement:

1. Average emission factor,
2. Screening ranges / stratified factors,
3. EPA correlation and
4. Unit-specific correlation approach.

Except for the Average emission factor approach, all of the approaches require screening data. Screening data are collected by using a portable monitoring instrument to sample air from potential leak interfaces on individual pieces of equipment. A screening value is a measure of the concentration of leaking compounds in the ambient air that provides an indication of the leak rate from an equipment piece, and is measured in units of parts per million by volume (ppmv.). In addition to equipment counts and screening data, the Unit-specific correlation approach requires bagging data. Bagging data consist of screening values and their associated measured leak rates. A leak rate is measured by enclosing an equipment piece in a bag to determine the actual mass emission rate of the leak. The screening values and measured leak rates from several pieces of equipment are used to develop a unit-specific correlation. The resulting leak rate/screening value correlation predicts the mass emission rate as a function of the screening value.

Emissions of storage tanks and loading&unloading. are usually calculated based on general emission factors. Emissions from the utilities (wastewater treatment and cooling water system) are not always considered but can also calculated by general emission factors. Calculation methodologies are published by EPA and Concawe.

#### **IV.2 Remote sensing and other leak detection methods**

The annual emissions are calculated by extrapolation of the measurement time. Measuring times are relatively short. Hence attention should be paid to take into account the operational and meteorological conditions during the measuring versus annual average. Measuring in several periods of a year or during several years can increase accuracy in this respect.

- *Distributed point sources*: with the help a 'reverse' atmospheric dispersion model it is possible to calculate the emission from down-wind measured air quality data and meteorological data. In order to cover all potential emission sources it is common practice to monitor at several points. The method enables an estimation of the total emissions. The measuring may not cover high plume emissions. The (exact) location of a leakage is hard to indicate with this method.
- *Fixed beam (open-path) optical absorption methods*: the basic principle of a fixed beam (open-path) optical absorption method consists of absorption of an electromagnetic beam (IR and UV) by gases present in ambient air. Specific gases will absorb light from known parts of the spectrum, both in the UV, visible and IR wavelength ranges. From the absorption between the beam source and the detector coupled to a spectrometer and computer it is possible to calculate (the integrated) amount of VOC. High plume emissions may not be covered by the measuring. The (exact) location of a leakage is hard to indicate with this method.

- *Differential Absorption Lidar (DIAL)*: The optical methods have been further developed in the late nineties to overcome the main limitations (i.e. leakage localisation and non-detection of high leaking sources). The developed method is named DIAL (differential absorption LIDAR; LIDAR being light detection and ranging). The infrared laser beam source and the detector are located at the same end of the beam. The detector picks up the signal from the small amount of light scattered from aerosol droplets or particles in the atmosphere. The main advantages of DIAL over fixed beam methods are that gas concentration is measured at all points along the path and no height limitations exist. This allows building up 2/3-D maps of gas concentration. It is possible to localise the emissions within large industrial complexes. In other words DIAL enables both estimation of the total emission flux and localisation of (unexpected) leakage sources. It covers all potential emission sources (equipment, storage, loading/unloading, waste water system, etc.). However it has its limitations in the accuracy of the localisation and in the differentiation into different chemical compounds. Nevertheless DIAL is an outstanding technology complementary to standard point by point leak detection (screening ranges or correlation method).
- *Tracer gas*: The tracer gas method consists of releasing a tracer gas (usually SF<sub>6</sub>) at different identified release areas and at various heights above the surface in the factory area and of measuring the VOC & tracer gas concentrations downwind of the factory by portable syringe-based samplers or portable gas chromatographs. The emission rates of specific hydrocarbons can be estimated from simple flux assumptions with near stationary wind conditions and with no significant atmospheric reactions or deposition of hydrocarbons or other release gases between the leakage points and the sampling points.

### **IV.3 Leak detection and repair (LDAR)**

The main objective of the EPA fugitive emission estimation methods is to assist the leak detection and repair programme (LDAR). LDAR is compulsory for the process industry. It consists of checking the components for leakage and of repairing the identified leaking components. The check on leakage is performed by the EPA reference method 21 and has to be executed quarterly or annually. It should be noticed that in practice the inaccessible components are not monitored (e.g. for reasons of insulation, height).

Trained sniffer dogs can optimise LDAR. Monitoring is only performed at components, which the dog points out as leaking. The detection by dogs has been verified by a certification institute [The sniffers]. Other possibilities to enhance detection have developed, such as VOC-sensitive tubes and tapes.

### **IV.4 Practice in the EU member states**

The most widely used estimation method for the first estimation of the emissions, is the average emission factor method. The default emission factors are often EPA's, the German set of emission factors [VDI-3479] and the Netherlands' set of emission factors [KWS2000 FS18].

Significant product leakage from process components may cause hazardous situations leading to fire, explosion or intoxication of the personnel. Hence occupational safety considerations imply that all industrial process plants inspect process components on a regular basis. In this sense, all large chemical industries and refineries have a leak detection and repair programme.

However, this does not mean that these companies have a LDAR which is comparable to the EPA standards (monitoring of all components quarterly or annually). Only in some of the companies does a LDAR include measuring of a substantial part of equipment components annually.

The commonly used method to identify leaks and to estimate annual emissions is the EPA method 21. As only a small number of components are leaking (less than 1%) several methods are applied to screen more cost-effectively, i.e. restricting the measurements to those components that are more vulnerable to leaking. More and more (international) companies assist the detection programme by remote sensing techniques. Leak detection assisted by trained sniffer dogs is also becoming more common.

The most widely used estimation methods for estimations of the emissions of storage tanks and loading and unloading are the EPA AP42 [EPA-AP42] and similar methods ([VDI 3479], [NL-KWS2000 FS19]).

Remote sensing techniques are applied increasingly and DIAL has become common practise in some of the countries for estimation of the annual VOC emission. Also the tracer gas method is used on regular basis in some member states.

#### **IV.5 Discussion of the emission estimation methods**

The features of the presented methods differ considerably. The ideal method in the context of licensing and enforcement should have at least the following features:

- suitable for equipment, storage tanks and loading&unloading
- suitable for leak detection (all compounds, all locations)
- suitable for estimation of the annual emission
- real time estimation
- easy inspection for enforcement
- inexpensive.

None of the reported available methods comes close to the ideal method. Hence a combination of methods is required to manage diffuse emissions. A suitable approach is presented in the action plan (annex D).

It should be clear that it is practically impossible to measure the exact amount of diffuse emissions released during a year. The amount has to be estimated. The described methods will usually lead to considerably different results. Comparison the results of different methods it is in most cases not straightforward. However it may be crucial to judge a claimed emission reduction. The following discussion is intended to assist in this respect.

Estimation based measurement should be considered more reliable than based on average emission factors only. Nevertheless an average emission factors estimation will provide the right order of magnitude. Comparison studies differ in their conclusions but remarkably often it has been found that the average emission factors provide indeed the right order of magnitude.

The component measurements consist of measuring the hydrocarbon concentration nearby the component. From the measured concentration, the annual emission can be estimated by calculation according to different equations. The correlation equation is considered the most accurate estimation but screening ranges/stratified factors method is more widely used in the EU.

Comparing the different calculation methods the following conclusions can be drawn:

- the emission estimation may differ significantly from one calculation method to another (difference in order of magnitude);
- the average emission method does not reflect the emission in accordance with the condition of the plant but will reflect the average condition only;
- either the screening range or the stratified method will result in a slightly higher estimated emission;
- the correlation method will result in a considerable lower estimated emission.

Differences in the results of component measurements and remote sensing measurements need to be investigated. It is important to note that remote sensing techniques cover all emissions, not diffuse emissions only. Hence the emissions of all potential emission sources should be estimated.

## **V. Measures to reduce VOC emissions**

Diffuse emissions are originated by intrinsic leakage of equipment and of 'leaking' equipment. The latter may be related to inadequate design, installation, handling & maintenance of the equipment and external impact. An example of inadequate design is the choice of a material that is not suited for operational conditions (e.g. corrosion, pressure, temperature), either at the designed process conditions or following changes in process conditions. An example of inadequate handling is the non-tight closing of valves, flanges, drains, etc. Good maintenance should prevent the occurrence of equipment failure. An example of external impact is an object falling on process equipment.

It is clear that only good management and a good maintenance programme can guarantee the lowest emissions of an installation. As these programmes are not specific for diffuse emissions, management systems and maintenance programmes are not further discussed. In addition to these general measures a leak detection and repair programme is important.

*A leak detection and repair programme (LDAR) aims to reduce emissions by regularly checking the equipment for any abnormal leak and repairing if necessary. Measuring techniques and a measuring strategy are given in the EPA protocol for equipment leak emission estimates [EPA'95].*

### **V.1 Equipment**

A variety of 'low emission' components exists, especially for toxic, flammable and odious substances. Whether a component is a relevant or irrelevant fugitive emission source, depends on a lot of parameters, such as process conditions, investment and operational cost, resistance, reliability, maintenance capabilities, etc. There is no rigid rule. As previously explained the selection of equipment is complex. No specific guidelines exist for the selection of equipment with respect to diffuse emissions. General guidance documents however do exist, e.g. the German guidelines [VDI 479/3790/2440 (draft)]. Low emission components are presented in the annex B.

## V.2 Storage tanks, loading&unloading and utilities

The three technical items that are related to the emission of a storage tank are tank design, sealing and vapour handling. In general fixed roofs tanks are characterised with larger emissions than floating roof tanks for a given product. However as volatile products now often are stored in floating roof tanks, the VOC emissions of these floating roof tanks tend to be higher than the emissions of a fixed roof containing a non-volatile product like e.g. fuel oil.

The emissions of a fixed roof tank can be reduced by a large extent, using a vapour treatment system, such as:

- vapour balancing
- vapour recovery (e.g. by condensation or adsorption)
- vapour incineration.

The common requirements on the storage of large volume liquids such as motor fuels are floating roof tanks, vapour balancing system or vapour treatment system. Requirements for loading & unloading vessels are given in e.g. IMO guidelines. For crude receipt, the change over to segregated ballast with tanker fleet renewal over time (prescribed in the MARPOL 73/78 Convention) has the side effect of reducing hydrocarbon emissions at crude oil discharge locations. The gasoline loading & unloading of rail way and truck containers is regulated by the EU Council Directive 94/63/EC (VOC vapours at the dispatch stations to be recovered in a vapour recovery unit). The publication of an EU Directive on barge loading regulation is announced.

## V.3 Practice in the EU member states

Specific standards for process equipment with respect to diffuse emissions do not exist. A few general guidance documents are used, such as the German TA-Luft & VDI-3479/3790 and the British ETBPP documents. More information is referenced in paragraph 4.2. The VOC Stage 1 Council Directive 94/63/EC specifies special requirements for the storage of large volume liquids such as motor fuels. Floating roof tanks or vapour balancing systems are required in most countries, e.g. regulated in Austria by [AU'91]&[AU'95] or considered as BAT.

## VI. Licensing and enforcement practice

As clearly stated in the IPPC Directive [96/61/EC] large industrial installations must have an environmental permit. The permit must include requirements in accordance with the standards of Best Available Techniques (BAT), also related to diffuse emission. The permit must include requirements on monitoring of emissions and reporting to the authorities.

Technical requirements are mostly specified in fairly general definitions, which gives the permit holder the freedom of choosing between a range of apparatus according to BAT (e.g. [TA Luft]).

General requirements related to diffuse emissions are:

- Annual emission estimation
- Measuring programme
- Leak detection and repair programme
- 'Low emission' techniques
- Emission target (absolute value or relative value)

Furthermore the competent authority might supplement its enforcement program with technical assistance:

- Eco-audit
- Training programme, seminar or other educational forum
- Reliance on third parties.

Several options exist to check compliance of the permit requirements. The most common options are:

- Site inspection by the Competent Authority
- Inspection of company data by the Competent Authority
- Validation of company data by third party.

## **VII. Recommendations**

The review revealed that emission monitoring and reporting of the diffuse VOC emission to the competent authorities is not yet common practice in all EU member states. Also requirements with respect to diffuse emissions are either missing in permits or are prescribed in rather vague terms. Diffuse emissions have actually not yet caught the attention in all member states.

The IPPC Directive stipulates that the permit shall include emission limit values (amongst others for VOC). Emissions include diffuse sources in the installation into the air. The Directive also requires the operator to supply the competent authority with data required for checking compliance with the permit and requires the operator to inform the competent authority on the results of the monitoring. Results must also be made available to the Public.

This report may provide valuable input to the development of several BAT reference notes with respect to diffuse emissions. New measuring and low emissions techniques have emerged recently and are being applied successfully.

From these and their own observations the members of the IMPEL Working Group on diffuse emission draw the conclusion that a clear need exists for a licensing and enforcement guidance note with respect to diffuse emissions. Recommendations are given in the following paragraphs. An example of a diffuse emissions action plan is presented in annex D.

### **VII.1 Identification of industries with potential relevant emissions**

In order to identify industries with relevant emissions it is recommended that:

- Process industry handling organic liquids or gases in large volumes are investigated for their VOC emissions. The tank terminals, petroleum refineries and the organic chemical industry are most concerned. Total VOC emissions are typically above of 10-100 ton/a. The organic compounds may include toxic and/or smelly substances.

### **VII.2 Target or limit value**

The IPPC Directive stipulates that the permit conditions shall include emission limit value for pollutants. It is recommended to distinguish diffuse emissions separately. Examples are:

- setting a target on the total emissions; feasible reduction percentages depends on the initial situation.
- setting a target on the admissible number of leaking equipment. An example is given annex C.

The former requirement is of course more relevant for judgement of the environmental impact but exact quantification of the emission tends to be difficult. The latter requirement is easier to verify by enforcement authorities. Whatever the basis, a clear definition of the reference situation and limit is paramount. The emission calculation method and definition of a "leaking" component should be unambiguous.

### **VII.3 Procedural measures**

It is recommended that the environmental permit may include the following procedural measures:

- a leak detection and repair programme (LDAR) based on regular measuring of all accessible components, storage tanks and loading&unloading facilities; records of the detected leaks shall be maintained and reported regularly for checking of the compliance by the authorities.
- the monitoring results should be reported to the authorities [IPPC], e.g. the estimated total emission, the number of detected leaking components, the number of repaired/ replaced components and comparison with previous measurements.
- Maintenance should be geared to emission prevention.

The enforcement authorities can verify the execution of a LDAR by:

- checking the existence and regular updating of component measurements.
- checking just repaired units by measuring at the components.

### **VII.4 Emission estimation**

Emission estimation of all atmospheric emissions, including diffuse VOC emissions is laid down in the IPPC, as well as reporting to the competent authorities. It is recommended that the licensing Authorities take the following requirements into account:

- Companies indicate their monitoring methods.

- All identified industries provide a report on the atmospheric emissions covering all diffuse emissions sources regularly, e.g. on an annual basis. The concerned company is able to specify the emission calculation method for every single source at request of the competent authority.
- The emission monitoring (and control) should be approved by the competent authorities. An example of an appropriate emission monitoring plan is presented in annex D.

As the emission estimation may vary by order of magnitude according to the used calculation method it is paramount that emission calculation method is defined and that the definition is unambiguous. Also the monitoring and reporting frequency should be defined.

The enforcement authorities can verify the emission estimation by checking:

- the methodologies used and the applied emission factors
- if the estimation covers all relevant emission sources
- the use of remote sensing techniques (especially DIAL).

## **VII.5 Technical measures**

The application of BAT is laid down in the IPPC. Examples of good practice are presented in annex B. It is recommended that the licensing Authorities should require:

- In case of new installations, companies to justify their technology choice in relation to BAT; in case of existing installations, companies should agree an action plan to upgrade the installation to BAT standards.
- The requirements for the storage, loading & unloading of gasoline (-like products) should be based on the VOC stage I Council Directive 94/63/EC.

The enforcement authorities can verify the application of BAT by:

- checking the relevant documents (e.g. the ETBPP publications, German standards).
- site visit and checking of the installation and provisions (e.g. presence of cap or plug on open-ended lines) and proper operation (e.g. use of vapour recovery system or the execution of the repair programme)

It should be noticed that proper installation, operation and maintenance of the equipment are paramount. It has to be recognised that in all installations some components will leak to some extent. Notwithstanding that this situation is accepted, large uncontrolled leaks should not be acceptable. Different levels of response (e.g. immediate, short term, long term) could be defined for different leak sizes (see paragraph 4.2, Sweden for an example).

## **VII.6 Non-compliance**

In case of non-compliance the authority may decide to:

- have the plant audited resulting in additional permit conditions;
- initiate a leak detection and programme by a contractor at the cost of the plant.
- actively inform the public about the non-compliance.



It is emphasised that the permit requirements should be 'measurable' in order to provide unambiguous proof of compliance or non-compliance. Examples of measurable requirements related to diffuse emissions are:

- the annual emission reporting with a break-down of all emission sources;
- the presence and operation of technical measures (e.g. vapour recovery system);
- a leak detection programme by measurements through the check of the measuring data;
- a target on the admissible number of leaking components.

### **VII.7 Supporting activities**

Supporting activities may be considered by the authorities, such as:

- organising an information & training programme in regions where the subject is relatively new (targeting both companies and licensing & enforcing bodies)
- establishing national guidelines
- performing an eco-audit of the industrial plant
- establishing a helpdesk to assist both companies and licensing & enforcing bodies .

It is recommended that the IMPEL organisation set up an EU wide information exchange programme on the licensing and enforcement practice in relation to diffuse VOC emissions. Such programme could include a bench marking on subjects like estimation methods and measures; the latter (measures) preferably with a clear link to the BREF programme.



## **1 Introduction**

### **1.1 Background**

Establishing an environmental policy for industrial sources usually commences with a regulation of the large point sources. Attention is then focused on piped emissions, e.g. exhaust gases directed via a stack and wastewater through a discharge pipe. In general these piped emissions are well regulated and have been reduced substantially, to such an extent that the other emissions have become more and more dominating. With respect to atmospheric emissions of volatile organic emissions (VOC) these 'other emissions' comprise mainly leakage from equipment (fugitive emissions) and evaporation losses of storage, loading and unloading. These emissions are called 'diffuse' emissions. Monitoring of diffuse emissions is more complex compared with monitoring of piped emission sources. Abatement and regulation of diffuse emissions is a relatively new issue in some member states of the European Union (EU). It is however not common practice in all EU member states, this contrary to the USA where it is common practice for about 10 - 20 years.

The main environmental effect of VOC in general is their role in the formation of smog and ozone in the presence of nitrogen oxides. VOC in the ambient air are precursors to the formation of ground level (tropospheric) ozone, the primary constituent of smog. Smog and ozone cause respiratory damage, damage to property and vegetation (agriculture and ecosystems). Individual components of VOC are known for other negative effects such as toxic effects on health and ozone layer depletion in the stratosphere. Reduction of VOC emissions is not only beneficiary to the environment but also can lead to better workplace conditions, can reduce risks of fire, can reduce nuisance (odours) and can save money.

IMPEL, the environmental inspectors network for the EU, has defined a project on diffuse emissions. The intention is to provide guidelines for implementing diffuse emissions regulations, both for licensing of industrial plants and for enforcement. The Netherlands' Inspectorate for the Environment is in charge of the project and commissioned Tebodin to assist as consultant.

### **1.2 Objective**

The objective of the project is to review the diffuse VOC emissions estimation methods and measures in the EU and to propose guidelines in order to improve the monitoring, licensing and inspection of industrial activities.

### **1.3 Scope and definitions**

The project is focused on the VOC emissions of diffuse sources of large process installations, both fugitive emissions (leakage from equipment) and emissions from storage tanks and loading/unloading. The installations & emissions are common in refineries and (petro-) chemical plants.

The following definitions are used in the project:

**Volatile organic compounds (VOC):** any organic compound having at 293.15 K a vapour pressure of 0.01 kPa or more, or having a corresponding volatility under the particular conditions of use (VOC as defined by EC Directive 1999/13/EC of 11 March 1999, Article 2 sub 17).

**Diffuse emissions:** all emissions that are not released via specific emission points (stacks, etc.); e.g. leakage from equipment (= fugitive emissions), loading&unloading operations, evaporation losses from storage tanks and waste water treatment; excluded are emissions resulting from the use of solvents which are regulated by the EC Directive 1999/13/EC.

**Fugitive emissions:** all emissions that are released as leakage from equipment, e.g. leaking from seals (= part of diffuse emissions)

**Activities:** activities of the process industry, including e.g. (petro)chemical industry, petroleum refineries and tank terminals; excluded are dry cleaning, printing industry, gas/oil exploration & production, off-shore and military activities (IPPC Directive, Annex I categories 1 to 6, excluding 5.4, 6.6 and 6.7).

VOC may contain non-hydrocarbon (HC) atoms such as sulphur, chlorine and oxygen. Examples of VOC are gasoline, hexane, methyl- isobutylketone. VOC may include substances that are toxic to man, animals and plants (e.g. benzene being part of gasoline; ethene for plants), smelling substances (e.g. mercaptans in crude oil) or undesirable for other environmental reasons (chlorofluorohydrocarbons in relation to ozone layer depletion; methane in relation to global warming). The presence of such substances would require more a rigid regulation and close control.

Opinions differ on the amount of VOC emissions that are to be considered as relevant. E.g. emission threshold limits are used in the UK and in the Netherlands for reporting of the emissions to the Authorities. For VOC without specific toxic effects, the UK minimum reporting level equals 1 ton/a per product unit [CRI '97] and the Netherlands' minimum reporting level equals 100 ton/a per product unit [VROM'98]. The exact amount of VOC emission is of minor importance for the purpose of this study as relevance depends largely on local geographical circumstances. As a guidance note an emission level of 10-100 ton/a can be called relevant.

Different definitions of diffuse emissions are in use. In all cases the emissions, which originate as leakage from fittings, flanges, pumps, etc are part of diffuse emissions. These emissions of equipment leakage are called fugitive emissions in this report. Emissions of safety valves connected to a recovery/flare system and flares are not covered by the definition, as the equipment components are part of a piped system, the emission point is well defined and can be measured accurately. The emissions originated at storage tanks and during loading&unloading are not fugitive emissions in the strict sense (emissions are unavoidable and emission points are fairly well defined) but emissions are difficult to measure, the actual situation during operation may vary considerable (meteorological conditions, variety of connections and nozzle systems). These emissions are also targeted in the context of this report. Within the EU member states, dedicated programmes are addressed to fugitive emissions (e.g. UK) and to diffuse emissions (e.g. Germany, the Netherlands).

The typical diffuse emissions sources are illustrated in figure 1.1.

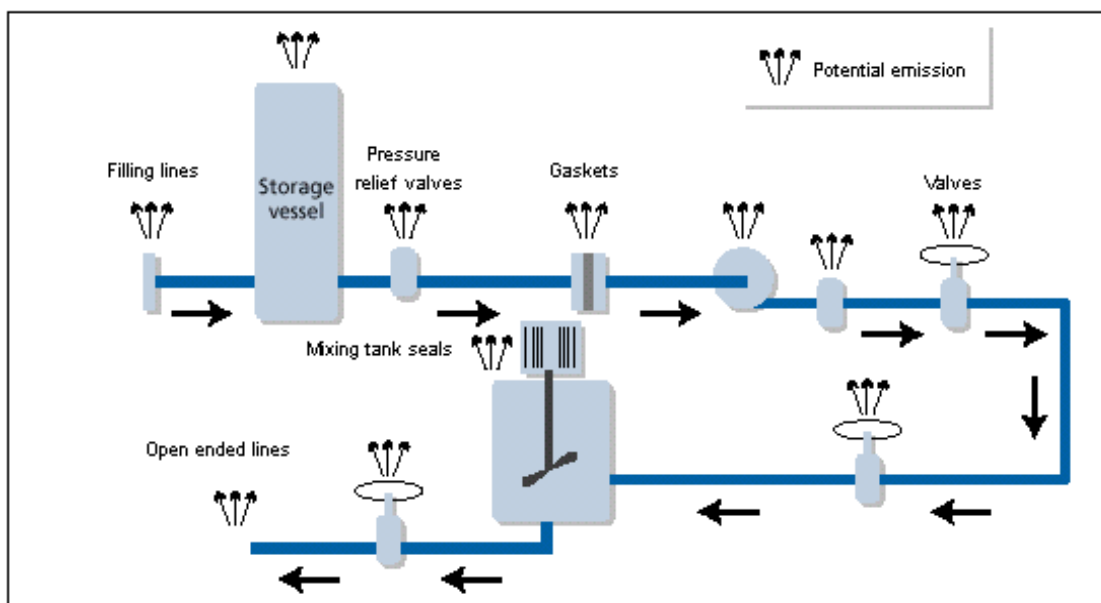

**Figure 1.1- Typical sources of diffuse emissions (after [ETBPP-GG71]).**

Although the targeted activities are restricted to the process industry it should be clear that various of the presented measuring methods, reduction techniques and licensing&enforcement practice are also applicable to other activities such as (off-shore) gas&oil exploration/production and military activities. Some of the remote sensing methods are well suited for measuring the diffuse emissions of landfill sites (e.g. methane leakage).

#### 1.4 VOC emission sources

In order to put the diffuse VOC emissions into perspective the contribution of the diffuse emissions to the total emissions has been estimated. Details are given in annex F.

In order to judge the contribution the compounds to be considered are actually NMVOC, i.e. VOC without methane. The European methane emissions account for about two thirds of the VOC emissions [EEA'98]; methane has a different environmental impact and the main sources are different (natural gas distribution networks, coal mining an agriculture).

The main NMVOC sources in Europe are mobile and natural sources. The main NMVOC emission sources are presented in figure 1.2.

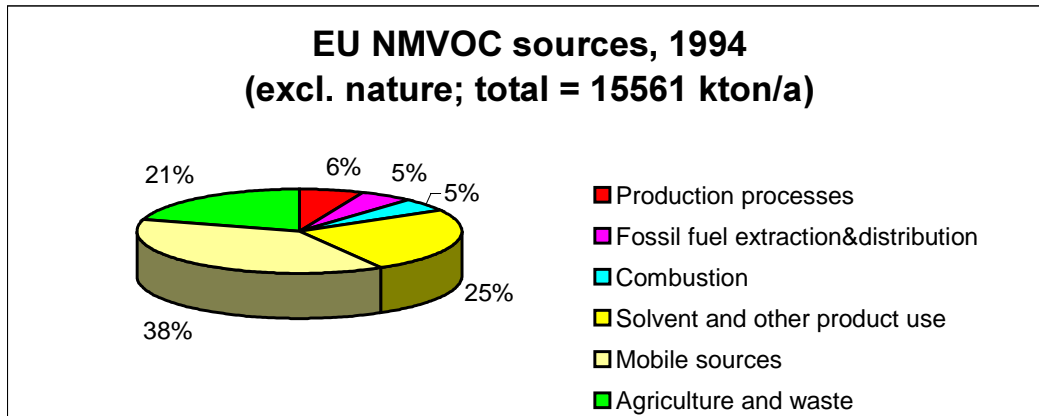

**Figure 1.2 - Sector split of NMVOC emissions of EU – 1994 [Corinair'94].**

The contribution of industrial non-combustion sources (industrial processes + extraction and distribution of fossil fuels) amounts to about 11%.

The main emission sources of industrial NMVOC emissions excluding solvent use are storage, loading & unloading and process equipment (fugitive emissions). The contribution of fugitive emissions on site level varies but the order of magnitude for a large integrated chemical plant is about 5-25%. An example for a Swedish refinery is presented in figure 1.3. As well as for the production processes as for the distribution of refinery products the contribution of fugitive emissions is approximately 8% of the total VOC emission [Corinair'94].

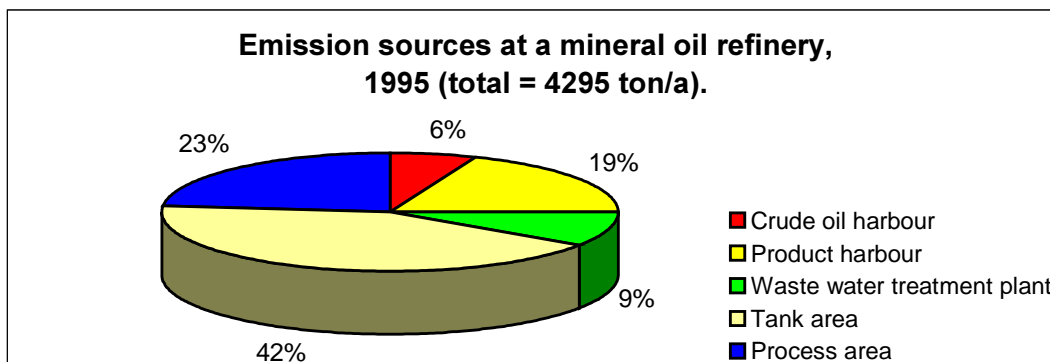

(Based on DIAL measurements [Janson'99])

**Figure 1.3 - Emission sources at a factory: a Swedish mineral oil refinery (10 Mton crude oil/a).**

## **1.5 European VOC policy**

### **1.5.1 VOC targets**

A significant VOC emission reduction in Europe is the objective of several protocols and policy plans. A brief overview of the (European) VOC reduction policy and targets is presented in annex F.

### **1.5.2 IPPC**

The project has a clear link to the IPPC Directive [96/61/EC]. The application of Best Available Techniques (BAT) is a cornerstone of the Directive and diffuse emissions are a subject that needs to be addressed in the environmental permit.

It is the intention of the European IPPC Bureau in Sevilla to develop BAT reference documents for about 30 industrial sectors and a few general subjects. Of interest are the sectors 'refineries', 'large volume organic chemicals' and 'storage' and the subject 'monitoring'. These sectors BAT reference documents are being prepared. The document on mineral oil refinery is available as draft [BREF'00]. The main paragraphs on diffuse emissions are added as annex H.

The Technical Working Group on monitoring will cover the monitoring of fugitive emissions. It is however not their intention to provide a BAT reference document as it is not intended to specify the best monitoring techniques but it is their intention to provide an exchange of views and practices [IPPC'99] to enhance the licensing.

## **1.6 Approach**

The project commenced with a literature review. The review was completed by an EU wide inventory, executed in close co-operation with the members of the IMPEL working group. The findings were summarised in this document, which was discussed in two meetings of the Working Group.

The central topics of the inventory and of this document are:

1. VOC: emission estimation methods
2. measures to reduce VOC emissions
3. licensing and enforcement practice.





## 2 Emission estimation methods

### 2.1 General

Estimation of diffuse emissions is more difficult and complex than estimating piped emissions (e.g. by stack measurement). A variety of methods have been developed. The methods range from calculation to measurement, point measuring to remote sensing. The presented overview is focused on methods to identify leaks and methods to estimate the annual emission.

The methods are presented in three paragraphs:

- methods suitable for equipment components (fugitive emissions; paragraph 2.2)
- methods suitable for storage tanks, loading&unloading and utilities (paragraph 2.3)
- remote sensing, which is suitable for all emission sources (paragraph 2.4).

It should be realised that the guidelines of the United States Environmental Protection Agency (EPA) are widely used in the EU member states. Also the methods that are developed within a member state are often based on the EPA guidelines and the emission estimating equations that are developed by the American Petroleum Institute (API). Interesting emission estimation methods of EPA and API are referenced in the literature overview (chapter 6).

### 2.2 Equipment

The United States Environmental Protection Agency (EPA) issued the Protocol for Equipment Leak Emission Estimates [EPA'95]. According to this protocol, different approaches can be used to estimate emissions. These approaches are, in order of increasing refinement:

1. Average emission factor,
2. Screening ranges / stratified factors,
3. EPA correlation and
4. Unit-specific correlation approach.

All approaches require an accurate count of equipment components by type of equipment (i.e., valves, pumps, connectors, etc.). Additionally, for some of the equipment types, the count must be further described by service (i.e. heavy liquid, light liquid, and gas).

Except for the average emission factor approach, all of the approaches require screening data. Screening data are collected by using a portable monitoring instrument to sample air from potential leak interfaces on individual pieces of equipment. A screening value is a measure of the concentration of leaking compounds in the ambient air that provides an indication of the leak rate from an equipment piece, and is measured in units of parts per million by volume (ppmv.).

In addition to equipment counts and screening data, the unit-specific correlation approach requires bagging data. Bagging data consist of screening values and their associated measured leak rates. A leak rate is measured by enclosing an equipment piece in a bag to determine the actual mass emission rate of the leak. The screening values and measured leak rates from several pieces of equipment are used to develop a unit-specific correlation. The resulting leak rate/screening value correlation predicts the mass emission rate as a function of the screening value.

An overview scheme is presented in figure 2.1.

### EPA Emission estimation methods (by increasing refinement)

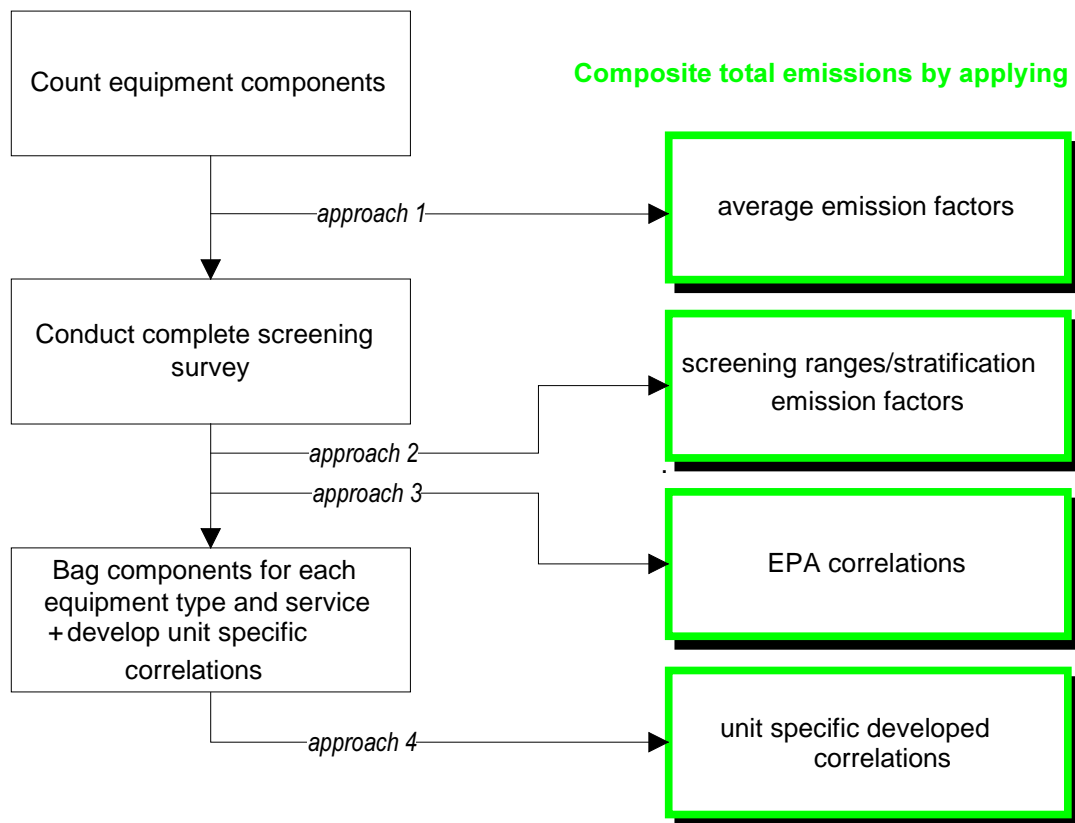

**Figure 2.1: EPA approaches to fugitive emissions estimation.**

#### 2.2.1 Average emission factor method

The average emission factor approach is commonly used to calculate emissions when site-specific screening data are unavailable, e.g. in the case of new installations.

The emission is calculated using average component specific emission factors. The following data of the units should be available:

- number and type of components (valve, connector, ...);
- medium characteristics (gas, light/heavy liquid, ...; VOC contents);
- time period that the component was in service.

EPA has developed average emission factors for process units, refineries, marketing terminals and oil&gas production operations. [EPA, 1995]

Default emission factors have also been developed in Germany and the Netherlands (see par. 4.2). Although most emission factors have been based on the EPA emission factors, emission factors may vary depending on the literature source.

<b>Estimating Emissions Using Average Emission Factors</b>				
This example demonstrates the use of this technique for a plant using light liquid solvents.				
Equipment	Service	Number of sources	Emission factor (kg/hour/source)	Total emissions (kg/hour)
Valves	Light liquid	94	0.007	0.658
Pump seals	Light liquid	14	0.050	0.700
Flanges	All	251	0.0008	0.201
Pressure relief devices	Gas/vapour	21	0.104	2.18
Total				3.79
Annual total (8760 hrs)				33.2 tonnes

**Figure 2.2 – Example of estimating fugitive emissions using average emission factors [KWS2000-19].**

### 2.2.2 Screening ranges / stratification method

The screening ranges method may be applied when screening data are available. The measuring consists of determining the concentration near an equipment component (called 'sniffing'). The measured value is used to classify the component into ranges 'greater than or equal to 10,000 ppmv' (called leaking component) or 'less than 10,000 ppmv' (scarcely leaking component). For each class (leaking or scarcely leaking) component specific emission factors have been developed for process units, refineries marketing terminals and oil&gas production operations. [EPA, 1995]

The method is applied in a similar manner as the average emission factors approach (i.e. equipment counts are multiplied by the applicable emission factor). The difference consists of use of measurements results (the screening value) to choose applicable emission factor. The stratification method is a variation of the screening ranges method. Instead of two classes of emission factors ('< 10,000 ppm' and '≥ 10,000 ppm') three classes are used ('<1,000 ppm', '1,000-10,000 ppm' and '≥ 10,000 ppm'). The screening ranges (stratification) method is no longer the preferred method in the USA but is still common within several EU countries. The preferred method in the USA is the correlation method (see next paragraph) because with the same monitoring data (screening values) a more precise result can be obtained by applying the suitable correlation equations.

Comparison with the average emission factors method highlights the greater accuracy that can be obtained by identifying which components are actually leaking before estimating the extent of fugitive emissions. Preliminary monitoring also helps to prioritise remedial work. The emission calculated by screening ranges methods is in most cases somewhat lower than calculated by the average emission factor method.

<b>Estimating fugitive emissions using screening ranges</b>				
At a plant using light liquid solvents, investigations have been carried out to determine the number of components that are actually leaking.				
Equipment	Service	Number of sources	Emission factor (kg/hr/source)	Total emissions (kg/hour)
Valves	Light liquid	4 Leaking	0.0852	0.34
		90 Non-leaking	0.0017	0.15
Pump seals	Light liquid	1 Leaking	0.437	0.44
		13 Non-leaking	0.0120	0.16
Flanges	All	1 Leaking	0.0375	0.04
		250 Non-leaking	0.00006	0.02
Pressure relief devices	Gas/vapour	1 Leaking	1.691	1.69
		20 Non-leaking	0.0447	0.89
Total				3.73
<b>Annual total</b>		<b>(8760 hrs)</b>		<b>32.6</b>

**Figure 2.3 – Example of estimating fugitive emissions using screening ranges refinery emission factors [EPA'95].**

### 2.2.3 Correlation method

The EPA correlation equation approach is the preferred method when actual screening values (see previous paragraph) are available. This approach involves entering the screening value into the correlation equation, which predicts the mass emission rate based on the screening value.

EPA has collected data on equipment leak emissions of organic compounds from refineries, marketing terminals, oil and gas production operations, and process units. Emission factors and correlations have been developed for the following equipment types: valves, pumps, compressors, pressure relief valves, connectors, flanges, and open-ended lines. An "others" category has also been developed for the petroleum industry.

The EPA correlation equations can be used to estimate emissions when the adjusted screening value (adjusted for the background concentration) is not a "pegged" screening value (the screening value that represents the upper detection limit of the monitoring device) or a "zero" screening value (the screening value that represents the minimum detection limit of the monitoring device). All non-zero and non-pegged screening values can be entered directly into the EPA correlation equation to predict the mass emissions (kg/hr) associated with the adjusted screening value (ppmv) measured by the monitoring device. An example of the correlation equations is presented in figure 2.3. The default zero emission rates are to be used only when the screening value (adjusted for background) equals 0.0 ppmv; if the monitoring device registers a pegged value, the appropriate pegged emission rate is to be used (otherwise the correlation equations).

### Estimating fugitive emissions using correlation equations

At a plant using light liquid solvents, investigations have been carried out to determine the number of components that are actually leaking.

#### Correlation equations, default zero emission rates, and pegged emission rates (kg/ hr per source).

Equipment Type	Default zero emission rate	Pegged emission rates		Correlation equation
		10,000 ppmv	100,000 ppmv	
Gas valves	6.6E- 07	0.024	0.11	Leak rate = $1.87\text{E}- 06 \times (\text{SV})^{0.873}$
Light liquid valves	4.9E- 07	0.036	0.15	Leak rate = $6.41\text{E}- 06 \times (\text{SV})^{0.797}$
Light liquid pumps	7.5E- 06	0.14	0.62	Leak rate = $1.90\text{E}- 05 \times (\text{SV})^{0.824}$
Connectors	6.1E- 07	0.044	0.22	Leak rate = $3.05\text{E}- 06 \times (\text{SV})^{0.885}$

#### Example 1

Equipment Type: Light-liquid Pumps

Hours of Operation: 8,760 hours

SV (Screening value) = 0 ppmv

Default-zero emission rate =  $7.5 \times 10^{-6}$  kg/hr/source

VOC emissions/equipment =  $7.5 \times 10^{-6}$  kg/hr  $\times$  8,760 hr/a = 0.066 kg/a.

#### Example 2

Equipment Type: Light-liquid Pumps

Hours of Operation: 8,760 hours

SV (Screening value) = 20 ppmv

Correlation Equation: TOC Leak Rate =  $1.90 \times 10^{-5} \times (20)^{0.824} = 2.24 \times 10^{-4}$  kg/hr

VOC emissions =  $2.24 \times 10^{-4}$  kg/hr  $\times$  8,760 hr/a = 2.0 kg/a.

**Figure 2.4 – Example of estimating fugitive emissions using correlation equations (SOCMI equations; [EPA'95]).**

For the purpose of an emission inventory only, usually a statistic relevant random sample is measured. This is in contrast to leak detection and repair programmes, which require that all components be measured.

Rather than using the EPA correlation equations, correlation equations may be developed for specific units. Once the correlation equations have been developed, they can be applied in the same way.

A separate set of emission factors has been developed by API [API, 4653] for pipeline facilities in addition to petroleum production facilities, refineries and marketing terminals. The emissions factors have been developed using the screening method of EPA 21 guidelines.

#### 2.2.4 Unit-specific correlation and EPA Reference method 21 for measuring

Establishing correlation equations requires a so-called 'bagging study'. First a quick scan of the apparatus is performed to identify 'leaking rate classes' (to present the whole leaking rate range). The emission leak rate from an equipment component is measured by bagging the component—that is, by isolating the component from ambient air to collect any leaking compound(s). A tent (i.e., bag) made of material impermeable to the compound(s) of interest is constructed around the leak interface of the piece of equipment. Two methods are generally employed in sampling source enclosures: the vacuum method and the blow-through (flushing) method.

Both methods involve enclosing individual equipment pieces with a bag and setting up a sampling train to collect two samples of leaking vapours to be taken to the laboratory for analysis. Both methods require that a screening value is obtained from the equipment prior to and after the equipment piece has been enclosed. The methods differ in the ways in which the carrier gas is conveyed through the bag. In the vacuum method, a vacuum pump is used to pull air through the bag. In the blow-through method, a carrier gas such as nitrogen (or other inert gas) is blown into the bag. The vacuum method is more commonly used in chemical processing industries for measuring relatively low leak rates; blow-through is more commonly used at petroleum refineries and is most valuable for measuring high leak rates.

The previous methods (screening ranges, correlation method) require measuring of equipment with respect to leaks. The widely used method measuring protocol is the EPA Reference method 21 [EPA21].

#### 2.2.5 Leak detection and repair (LDAR)

The main objective of the EPA emission estimation methods is to assist the leak detection and repair programme (LDAR). LDAR is compulsory for the process industry. It consists of checking the components for leakage and of repairing the identified leaking components. The check on leakage is performed by the EPA reference method 21 and has to be executed quarterly or annually.

A Leak Detection and Repair Programme (LDAR) commences with a component inventory with several characteristics of all potential leak sources, such as type of source, phase, product, size, location. Dedicated databases applications are available for the component inventory. These databases provide easy analysis of the results and easy emission reporting. After completion of the component inventory, the components can be measured with a portable leak detector according the EPA reference method 21. Leaks found should be repaired in order to reduce emissions. After repair, the leaks should be remonitored in order to check if the repair attempt was successful. If components are repeatedly found to be leaking, other solutions to prevent the leakage should be applied.

Two measuring strategies applied in practice:

1. All components are monitored in the initial phase:. After the initial survey covering all components, the measured data is compared and analysed. Based on the comparison and analysis, a plan can be made to monitor certain types of sources less frequent. This strategy is expensive in the initial phase, caused by database building and monitoring of all sources. But all leaks are detected and can be repaired as all components are monitored. This will cause a significant reduction of the emission, so that the cost per reduced amount of emission is acceptable.

After the initial phase the cost of the programme will be considerably less, due to the fact that the database is already built. The measuring of fewer components but with a higher leak probability may result in a cost per reduced amount of emission that is similar to the initial cost per reduced amount.

2. The components are monitored in successive phases: The survey consists of several successive phases measuring a part of the components per phase.(or program is only partly executed or spot checks are used). The cost of such a programme is less in the first phase but will remain the same (or increase) in future phases with a much lower emission reduction. The cost per reduced amount of emission will be higher. A complete program is usually already cheaper after the second monitoring cycle.

It should be noticed that in practice the inaccessible components are not monitored (e.g. for reasons of insulation, height).

### **2.2.6 Trained sniffer dogs**

The detection of the exact location of the leakage requires extensive monitoring. A complement to the human screening of equipment components is detection by trained dogs. Dogs are trained to identify a specific VOC and have been successfully applied throughout Europe.

The detection by dogs has been verified by a certification institute [The sniffers]. The use of this somewhat uncommon method is being appreciated by several companies. Quoting from [Borealis] 'dogs work whole-heartedly (without any prejudices), fast, efficiently, precisely and find those small leaks that one normally does not find. But dogs are limited to 1-2 gases and to 'accessible' locations.

### **2.2.7 Other methods**

VOC-sensitive tubes and tapes have been developed. The tubes and tapes contain reactive chemicals which change colour when brought into contact with VOC. The chemicals are specific for specific VOC compounds; complex VOC mixtures may be difficult to detect. The method is not suitable for quantification. Nevertheless the possibilities to establish a correlation with air quality and emission are being investigated.

## **2.3 Storage tanks, loading & unloading and utilities**

Most emissions originate from the storage tanks and loading&unloading. Emissions from the utilities (wastewater collection & treatment and cooling water system) are not always considered. Also contaminated soil and/or surface water are not always recognised as diffuse VOC emission sources.

Emissions from organic liquids in storage occur due to evaporative loss of the liquid during its storage and as a result of changes in the liquid level. The emission sources vary with tank design and maintenance, as does the relative contribution of each type of emission source.

Emissions from fixed roof tanks are a result of evaporative losses during storage (known as breathing losses or standing storage losses) and evaporative losses during filling and emptying operations (known as working losses). External and internal floating roof tanks are emission sources because of evaporative losses that occur during standing storage and withdrawal of liquid from the tank. Standing storage losses are a result of evaporative losses through rim seals, deck fittings, and/or deck seams. Variable vapour space tanks are also emission sources because of evaporative losses that result during filling operations.



**Figure 2.5 - Picture of a floating roof tank.**

Atmospheric emissions from a wastewater treatment system and cooling water system occur by the contamination of water systems. Wastewater treatment systems are clearly designed to handle the aqueous stream but treatment of VOC vapour is not always taken care of. Although the Parcom Recommendation 89/5 of 22 June 1989 states that cooling waters should be separated from other waters and remain uncontaminated by oil, cooling water systems may be contaminated by leakage from process equipment. In most cases the process design is such that a leakage of e.g. a heat exchanger will result in product leaking into the cooling water system.

### **2.3.1 EPA method**

The commonly used EPA procedure for tank emission estimation is presented in [EPA-AP42] and covers fixed roof, external floating roof, domed external floating roof and internal floating roof tanks. A subsidiary software tool (called 'Tanks') has been developed and can be downloaded from the EPA-internet site.

The emission is calculated using average emission factors. The following data of the tanks should be available:

- number of tanks and tank specifications;
- medium characteristics;
- tank operations;
- meteorological data (e.g. daily temperature variation).

The calculations of liquid storage tank emissions tend to be quite complex. For this reason no calculation example is presented here. Detailed examples for several types of storage tanks are given in [EPA-AP42].



### **2.3.2 Other methods**

The Concawe study report on cost-effectiveness of hydrocarbon emission controls [ref. Concawe'87] is also used as a reference for emission estimation from storage tanks and loading&unloading as well as for wastewater treatment systems and cooling water systems.

The remote sensing methods (see par. 2.4) are suitable to estimate emissions of storage tanks and loading & unloading and utilities. Also the possibility of using VOC-sensitive tapes around storage tanks for emission estimation is being investigated.

## **2.4 Remote sensing and other leak detection methods**

Remote sensing techniques have been improved considerably during the nineties. The techniques are discussed in order of 'sophistication'. An interesting feature of all remote sensing techniques is the ability to detect unexpected emission sources, like e.g. contaminated soil.

With the help of a 'reverse' atmospheric dispersion model it is possible to calculate the emission from down-wind measured air quality data and meteorological data. The annual emissions are calculated by extrapolation of the measurement time. Measuring times are often relatively short. Hence attention should be paid to take into account the operational and meteorological conditions during the measuring versus annual average. Measuring in several periods of a year or during several years can increase accuracy in this respect.

### **2.4.1 Distributed point sources**

The equipment of the distributed point sources method consists of typical air quality measuring device(s). In order to cover all potential emission sources it is common practice to monitor at several points. Instead of having fixed measuring points it is also possible to work with mobile continuous sensor.

The method enables an estimation of the total emissions. The measuring may not cover high plume emissions. The (exact) location of a leakage is hard to indicate with this method.

### **2.4.2 Fixed beam (open-path) optical absorption methods**

The basic principle of a fixed beam (open-path) optical absorption method consists of absorption of an electromagnetic beam (IR and UV) by gases present in ambient air. Specific gases will absorb light from known parts of the spectrum, both in the UV, visible and IR wavelength ranges. From the absorption between the beam source and the detector coupled to a spectrometer and computer it is possible to calculate (the integrated) amount of VOC. The monitoring path will typically be some hundreds of metres in length.

The method has been developed in the nineties and is now being standardised (e.g. VDI-4211/4210). Several variations on this principle exist (e.g. FTIR, DOAS). The method enables an estimation of the total emissions. High plume emissions may not be covered by the measuring. The (exact) location of a leakage is hard to indicate with this method.

### 2.4.3 Differential Absorption Lidar (DIAL)

The optical methods have been further developed in the late nineties to overcome the main limitations (i.e. leakage localisation and non-detection of high leaking sources). The developed method is named DIAL (differential absorption LIDAR; LIDAR being light detection and ranging). The infrared laser beam source and the detector are located at the same end of the beam.

The following paragraph describes how a DIAL remote sensing device is operated and an emission figure is produced.

There is a fortuitous coincidence of absorption features of non-methane, non-cyclic hydrocarbon, mainly alkane species, in the near to mid-infrared spectral region that allows to do measurements with DIAL. In the ultraviolet spectral range DIAL can only measure specific components, e.g. toluene. In case of a remote measurement system with two laser systems that can cover both the ultraviolet and the infrared spectral domain it is possible to measure the non-methane, non-cyclic hydrocarbon, mainly alkane species and aromatic species. Measurements of meteorological conditions and of VOC-concentrations are made orthogonal to the wind direction upwind and downwind of a targeted area. To get a full picture of the diffuse emissions of a plant where the emitted 'cocktail' is complex, you need a characterisation of all the components especially those that are not measured with the DIAL device. This information can be revealed by parallel measurements. To do so pumped sorption tubes analyses are made. With all this information, i.e. meteorological data, DIAL data and sorption tube data, an emission figure is calculated.



**Figure 2.6 - Example of a mobile DIAL measuring vehicle [NPL].**

The main advantages of DIAL over fixed beam methods are:

- gas concentration is measured at all points along the path;
- outstanding accuracy in localisation;
- no height limitations.

This allows building up 2/3-D maps of gas concentration. It is possible to localise the emissions within large industrial complexes. In other words DIAL enables both estimation of the total emission flux and localisation of (unexpected) leakage sources. It covers all potential emission sources (equipment, storage, loading/unloading, waste water system, etc.).

However it has its limitations in the accuracy of the localisation and in the differentiation into different chemical compounds. Nevertheless DIAL is an outstanding technology complementary to standard point by point leak detection (screening ranges or correlation method, see par. 2.2.2 and 2.2.3).

### 2.4.4 Tracer gas

The tracer gas method consists of releasing a tracer gas (usually SF<sub>6</sub>) at different identified release areas and at various heights above the surface in the factory area and of measuring the VOC & tracer gas concentrations downwind of the factory by portable absorption samplers (Dräger tubes) or portable gas chromatographs.

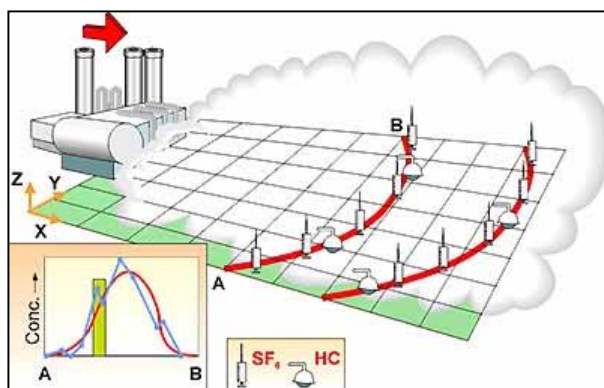

**Figure 2.7 - Lay-out of the tracer gas method [NILU]**

The emission rates of specific hydrocarbons can be estimated from simple flux assumptions with near stationary wind conditions and with no significant atmospheric reactions or deposition of hydrocarbons or other release gases between the leakage points and the sampling points. The release gas rates are usually adjusted to match the rough emission assumptions based upon screening studies undertaken prior to the tracer gas experiments.

The previous optical methods (paragraph 2.4.1.-2.4.3) can be combined with a tracer gas method (e.g.  $\text{SF}_6$ ). The known tracer gas emission can be used to calibrate the optical methods.

## 2.5 Practice in the EU member states

The most widely used estimation method for the first estimation of the emissions, is the average emission factor method. The default emission factors are often EPA's, the German set of emission factors [VDI-3479] and the Netherlands' set of emission factors [KWS2000 FS18]. Additional information is provided in paragraph 4.2.

Significant product leakage from process components may cause hazardous situations leading to fire, explosion or intoxication of the personnel. Hence occupational safety considerations imply that all industrial process plants inspect process components on a regular basis. In this sense, all large chemical industries and refineries have a leak detection and repair programme. However, this does not mean that these companies have a LDAR which is comparable to the EPA standards (monitoring of all components quarterly or annually). Only in some of the companies does a LDAR include measuring of a substantial part of equipment components annually. When available the measurements results of a LDAR are used to estimate the fugitive emissions.

The commonly used method to identify leaks and to estimate annual emissions is the EPA method 21. As only a small number of components are leaking (less than 1%) several methods are applied to screen more cost-effectively, i.e. restricting the measurements to those components that are more vulnerable to leaking. More and more (international) companies assist the detection programme by remote sensing techniques. Leak detection assisted by trained sniffer dogs is also becoming more common.

The most widely used estimation methods for estimations of the emissions of storage tanks and loading and unloading are the EPA AP42 [EPA-AP42] and similar methods ([VDI 3479], [NL-KWS2000 FS19]).

Remote sensing techniques are applied increasingly and DIAL has become common practise in some of the countries for estimation of the annual VOC emission. Also the tracer gas method is used on regular basis in some member states.

## 2.6 Evaluation of the methods

The features of the presented methods differ considerably. The ideal method in the context of licensing and enforcement should have at least the following features:

- suitable for equipment, storage tanks and loading&unloading
- suitable for leak detection (all compounds, all locations)
- suitable for estimation of the annual emission
- real time estimation
- easy inspection for enforcement
- inexpensive .

None of the reported available methods comes close to the ideal method. Hence a combination of methods is required to manage diffuse emissions. The main features of the methods are presented in Table 2.1.

The costs and the accuracy of the monitoring methods are discussed in paragraph 2.6.1-2.6.2.

**Table 2.1 – Features of the diffuse emission estimation methods and leak detection.**

Method	Equipment	Storage tanks, loading & unloading	Leak detection (suitable for LDAR)	Annual emission estimation	Accuracy	Real time emission estimation	Enforcement
Average emission factor	+	+	-	+	low	-	Data check is possible but tends to be time consuming
Screening ranges	+	-	+	+	medium	component	Check of documentation easy; field spot-check of repairs on identified leaks possible; complete inventory data check is almost impossible
Correlation	+	-	+	+	high	component	Check of documentation possible; field spot-check of repairs on identified leaks possible; complete inventory data check is almost impossible
Trained sniffer dogs	+	-	+	-	-	unit	Check of monitoring documents; could be used to check a part of installation during inspection visit
VOC-sensitive materials	+	-	+	-	-	component	Check of monitoring documents.
Distributed point sources, tracer gas	+	+	-	+	high	site	Check of monitoring documents and real time check
Fixed beam optical absorption	+	+	-	+	high	site	Check of monitoring documents and real time check
DIAL	+	+	+	+	very high	site	Check of monitoring documents and real time check

+ suitable; - not suitable.

### 2.6.1 Costs of the measurements

The magnitude of the costs depends on the size and type of the process installation. Three cases of imaginary factories have been worked out in order to give an impression of the typical costs.

**Table 2.2–Three typical configurations.**

	Petroleum refinery unit	Fine chemicals factory	Storage tank terminal
No. of equipment components	30000	3000	2500
No. of storage tanks	50	10	50
No. of products	10	50	50

An emission inventory/monitoring is often coupled to a LDAR (leak detection and repair programme), resulting in emission *reduction*. The monitoring costs have therefore also to be considered in combination with a LDAR. An indication of the costs to monitor the emissions is given in the following table, making distinction between methods suited for an emission inventory only, LDAR and LDAR supporting methods.

**Table 2.3 – Cost indication (order of magnitude) of the emission estimation methods (€; 1999).**

Method	Cost per unit	Petroleum refinery unit	Fine chemicals factory	Storage tank terminal
<b>Emission inventory only</b>				
Average emission factor	<sup>1)</sup>	5,000-15,000	2,500-5,000	2,500-7,500
Screening ranges or correlation (remark: not suited for storage tanks) <sup>2)</sup>	(see emission inventory being part of a LDAR)			
Distributed point sources	12,500 €/measurement	12,500	12,500	12,500
Fixed beam optical absorption	25,000 €/measurement	25,000	25,000	25,000
Differential absorption Lidar (DIAL)	10,000 €/day	150,000	50,000	30,000
<b>Emission inventory being part of a LDAR (leak detection and repair)</b>				
> once-only: component inventory	3 €/component	90,000	9,000	8,000
> annual <sup>3)</sup> : leak measuring	2 €/component	60,000	6,000	5,000
<b>LDAR supporting methods</b>				
Trained sniffer dogs	Methods will lower costs by improved leak detection.			
VOC-sensitive materials				
Differential absorption Lidar (DIAL) <sup>4)</sup>	10,000 €/day	150,000	50,000	30,000

- 1) Inventory required with type of source, phase, product; simple calculations for components; quite complicated calculation for storage tanks and loading&unloading.
- 2) Storage tanks and loading&unloading are not measured; have to be estimated otherwise (usually by average emission factors).
- 3) Annual or other frequency; the costs of the initial phase will amount to 3+2=5€/component as both component inventory and measurement are required.
- 4) First survey costs; following surveys and combining several factories tend to lower the costs.

## 2.6.2 Accuracy of the emission estimation

First of all it should be clear that it is practically impossible to measure the exact amount of diffuse emissions released during a year. The amount has to be estimated. The described methods will usually lead to considerably different results. Comparison the results of different methods it is in most cases not straightforward. However it may be crucial to judge a claimed emission reduction. The following discussion is intended to assist in this respect.

### Average emission factors versus measurements

Estimation based measurement should be considered more reliable than based on average emission factors only. Nevertheless an average emission factors estimation will provide the right order of magnitude. Comparison studies differ in their conclusions but remarkably often it has been found that the average emission factors provide indeed the right order of magnitude.

In case the estimated magnitude based on measurements differs considerably (more than factor 2) it is worth to look or ask for underlying reasons.

### Component measurements

The component measurements consist of measuring the hydrocarbon concentration nearby the component. From the measured concentration, the annual emission can be estimated by calculation according to different equations. The correlation equation is considered the most accurate estimation but screening ranges/stratified factors method is more widely used in the EU.

A detailed comparison of the different calculation methods is presented in annex F. The reader is recommended to consult this annex for gaining more feeling on the subject. Three situations are compared for a hypothetical plant to illustrate the impact of the method, i.e.:

- no leaking sources (hypothetical)
- average leaking sources
- severe leaking sources (higher emission rates than average)

The results are summarised in table 2.4.

**Table 2.4 - Comparison of emission calculation methods for a hypothetical plant (as fraction of the correlation method result for the average leaking situation).**

Calculation method	No leaking sources	Average leaking sources	Severe leaking sources
Average emission factor	10	10	10
Screening range method	1.2	8.5	23
Stratified factor method	0.49	10	25
Correlation method	0.0025	1	3.7

The comparison illustrates the following conclusions:

- the emission estimation may differ significantly from one calculation method to another (difference in order of magnitude);
- the average emission method does not reflect the emission in accordance with the condition of the plant but will reflect the average condition only;
- either the screening range or the stratified method will result in a slightly higher estimated emission;
- the correlation method will result in a considerable lower estimated emission.

The latter conclusion can be deduced by comparing the equations (figure 2.8) for a compressor.

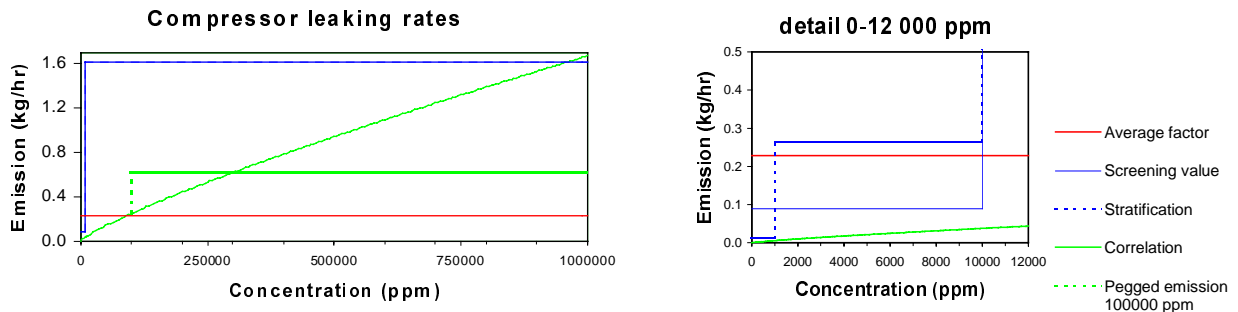

**Figure 2.8 – Graphic comparison of the different equations to calculate the emission rate based on an average emission factor and based on screening values (= concentration within 1 cm of the seal) of a compressor (SOCMI factors of [EPA'95]).**

The calculated emission is presented in the Y-axis; the measured hydrocarbons concentration in the X-axis. As the average factor method (red horizontal line) does not take any measurement into account, the calculated emission is fixed. The emission calculated according to the screening ranges / stratification method (blue horizontal lines with one/two leaps) varies stepwise with the measured concentration (respectively one and two leaps).

As the *high* emission factor of the screening ranges / stratification method corresponds to a high leaking situation, the calculated emissions tend to be overestimated. Furthermore the screening ranges / stratification method is not suitable to reflect *low* emission rates and will overestimate such situation. The emission calculated by the correlation method (green line) varies about linear with the measured concentration. As not all measuring devices are capable of measuring concentrations above 100,000 ppmv a fixed emission factor may be used (pegged emission; green horizontal line).

#### Component measurements versus remote sensing measurements

The results of component measurements (paragraph 2.3) and calculations of all other sources (hereafter called 'traditional' methods) may differ considerably with the results of remote sensing measurements (paragraph 2.4). The studies that compared both methods ('traditional' and remote sensing) differ in their conclusions. On one hand studies of Concauwe [Concauwe'95], IVL [IVL'95] and TNO [TNO'98] conclude that the results of remote sensing are consistent with the results of 'traditional' methods. On the other hand, the DIAL surveys lead consistently to higher results than the 'traditional' methods. A company that executes the DIAL measurements reports differences ranging from factor 3 to 18 for different refineries and loading&unloading facilities.

Differences in the results of component measurements and remote sensing measurements need to be investigated. It is important to note that remote sensing techniques cover all emissions, not diffuse emissions only. Hence the emissions of all potential emission sources should be estimated.

A considerably higher amount of emissions measured by remote sensing is often caused by a few leaks with a very high emission rate. Important errors of the 'traditional' methods are unknown emission sources (e.g. contaminated soil or surface water, cooling water system), non-applicability of equations due to different products or processes.



### **3 Measures to reduce VOC emissions**

#### **3.1 General emission reduction measures**

Diffuse emissions are originated by intrinsic leakage of equipment and of 'leaking' equipment. The latter may be related to inadequate design, installation, handling & maintenance of the equipment and external impact. An example of inadequate design is the choice of a material that is not suited for operational conditions (e.g. corrosion, pressure, temperature), either at the designed process conditions or following changes in process conditions. An example of inadequate handling is the non-tight closing of valves, flanges, drains, etc. Good maintenance should prevent the occurrence of equipment failure. An example of external impact is an object falling on process equipment.

It is clear that only good management and a good maintenance programme can guarantee the lowest emissions of an installation. As these programmes are not specific for diffuse emissions, management systems and maintenance programmes are not further discussed. In addition to these general measures a leak detection and repair programme is important.

*A leak detection and repair programme (LDAR)* aims to reduce emissions by regularly checking the equipment for any abnormal leak and repairing if necessary. Measuring techniques and a measuring strategy are given in the EPA protocol for equipment leak emission estimates [EPA'95] (see also paragraph 2.2.5).

#### **3.2 Equipment**

A variety of 'low emission' components exists, especially for toxic, flammable and odious substances. Whether a component is a relevant or irrelevant fugitive emission source, depends on a lot of parameters, such as process conditions, investment and operational cost, resistance, reliability, maintenance capabilities, etc. There is no rigid rule. As previously explained the selection of equipment is complex. No specific guidelines exist for the selection of equipment with respect to diffuse emissions. General guidance documents however do exist, e.g. the German guidelines [VDI 3479/3790/2440 (draft)].

The following equipment may form a relevant fugitive emission source:

- Valves
- Safety valves
- Pump seals
- Compressor seals
- Agitator seals
- Connectors/flanges
- Open-ended lines (loading/unloading hose, drains, ...)
- Open systems (e.g. oil/water separator, waste water treatment)

Low emission components are presented in the annex B.

### 3.3 Storage tanks, loading&unloading and utilities

The three technical items that are related to the emission of a storage tank are tank design, sealing and vapour handling. In general fixed roofs tanks are characterised with larger emissions than floating roof tanks for a given product. However as volatile products now often are stored in floating roof tanks, the VOC emissions of these floating roof tanks tend to be higher than the emissions of a fixed roof containing a non-volatile product like e.g. fuel oil.

Depending on the tank design the sealing may be applicable for the following components: floating roof (double seals are common), deck drains, rim vents, sample ports, emergency drains, guide poles, deck legs, swivels.

The emissions of a fixed roof tank can be reduced by a large extent, using a vapour treatment system, such as:

- vapour balancing
- vapour recovery (e.g. by condensation or adsorption)
- vapour incineration.

The common requirements on the storage of large volume liquids such as motor fuels are floating roof tanks, vapour balancing system or vapour treatment system. Requirements for loading & unloading vessels are given in e.g. IMO guidelines. For crude receipt, the change over to segregated ballast with tanker fleet renewal over time (prescribed in the MARPOL 73/78 Convention) has the side effect of reducing hydrocarbon emissions at crude oil discharge locations. The gasoline loading & unloading of rail way and truck containers is regulated by the EU Council Directive 94/63/EC (VOC vapours at the dispatch stations to be recovered in a vapour recovery unit). The publication of an EU Directive on barge loading regulation is announced.

### 3.4 Practice in the EU member states

Specific standards for process equipment with respect to diffuse emissions do not exist. A few general guidance documents are used, such as the German TA-Luft & VDI-3479/3790 and the British ETBPP documents. More information is referenced in paragraph 4.2.

The VOC Stage 1 Council Directive 94/63/EC specifies special requirements for the storage of large volume liquids such as motor fuels. Floating roof tanks or vapour balancing systems are required in most countries, e.g. regulated in Austria by [AU'91]&[AU'95] (according to 94/63/EG but the emission limit value for vapour recovery units is 10 g/m<sup>3</sup>/h) or considered as BAT.

As an example the main requirements related to the VOC Stage I Directive in the EU are:

a) loading: the units concerned have be designed and operated in a way that the petrol vapours displaced during loading are returned to the unit from which the product is loaded (vapour balance system). Furthermore, technical provisions have to ensure that the flow of the petrol is released only when a vapour collection hose has been installed between the tank and the transport vehicle.

b) storage: tanks equipped with floating-roof shall reduce emission at least with 95 % compared to emissions from fixed-roof tanks. The collected hydrocarbon vapours from the petrol tank farm have to be treated in a vapour recovery unit (VRU). The emission reduction of the VRU of tank farms not subjected to licensing (< 5,000 m<sup>3</sup> capacity) shall be at least 97 % and the emission concentration shall not exceed an limit value for VOC of 35 gr/m<sup>3</sup>. For installations subjected to licensing the emission limit value is 150 mg/m<sup>3</sup> (without methane). If the waste gas flow is less than 3 kg/h the emission value of 5 gr/m<sup>3</sup> shall not be exceeded. Road tankers have to be retrofitted with a below-level filling installation and with equipment for vapour balancing and over flow control until the end of the year 2004.



## 4 Licensing and enforcement practice

### 4.1 Licensing and enforcement in general

As clearly stated in the IPPC Directive [96/61/EC] large industrial installations must have an environmental permit. The permit must include requirements in accordance with the standards of Best Available Techniques (BAT), also related to diffuse emission. The permit must include requirements on monitoring of emissions and reporting to the authorities.

Best available techniques are defined in the IPPC as *'the most effective and advanced state in the development of activities and their methods of operation which indicate the practical suitability of particular techniques for providing in principle the basis for emission limit values designed to prevent, and where this is not practicable, generally to reduce emissions and the impact on the environment as a whole'*. Available techniques means *'those developed on a scale which allows implementation in the relevant industrial sector, under economically and technically viable conditions, taking into consideration the costs and advantages etc...'*. It should be noticed that historically the definition of BAT (or similar) used to vary from country to country. In some countries the emphasis was more on the *state of the art* aspect (e.g. in Germany where BAT means *the state of development of advanced processes, of facilities or modes of operation which is deemed to indicate the practical suitability of a particular technique for restricting emission levels*). In other countries there was more attention for the *economic* aspect (e.g. the UK's BATNEEC - best available techniques not entailing excessive costs - and the Netherlands' ALARA - as low as reasonably achievable-).

Technical requirements are mostly specified in fairly general definitions, which gives the permit holder the freedom of choosing between a range of apparatus according to BAT (e.g. [TA Luft]).

General requirements related to diffuse emissions are:

- Annual emission estimation
- Measuring programme
- Leak detection and repair programme
- 'Low emission' techniques
- Emission target (absolute value or relative value)

Furthermore the competent authority might supplement its enforcement program with technical assistance:

- Eco-audit
- Training programme, seminar or other educational forum
- Reliance on third parties.

Several options exist to check compliance of the permit requirements. The most common options are:

- Site inspection by the Competent Authority
- Inspection of company data by the Competent Authority
- Validation of company data by third party.

## 4.2 Practice in the EU member states and the USA

Some countries have developed guidelines for the licensing and enforcement of diffuse emissions. Most countries have no dedicated guidelines but specify the requirements in the environmental permit on a case by case basis. The leading principle is often BAT. These requirements are often comparable to those of the guidelines.

Some countries don't have any specific requirements related to diffuse emissions. Also reporting of annual emissions is not yet common practice in all countries.

Hereafter follows a short description of the practice in selected countries (specific regulation only). Examples of the requirements are given. Not mentioned are the compulsory emission monitoring and reporting to the authorities and the application of BAT.

### **Belgium (Flanders)**

A variety of emission estimation methods are used as no method has been outlined at federal/national level. The most common used estimation methods are the average emission methods (EPA/API, Concawe and the Netherlands' methods). More and more diffuse emissions are also measured (according to the EPA methodology). In some case remote sensing is applied (fixed beam optical absorption and DIAL). Notwithstanding these developments, systematic and regular emission monitoring of all diffuse emission sources by measurements is not yet common practice in all plants.

No general guidelines on diffuse emissions requirements exist. Requirements are specified in the individual environmental permits only. In order to give an impression of the requirements an example of the some main license requirements are given:

- Floating roof with double seals;
- vapour recovery and treatment, also for batch operations and non-continuous conditions (start-up, shut-down, regeneration phase, ...)
- double mechanical seals or better.

The environmental Inspectorate (competent authority) has checked the emission estimation results of the factory by its own measurements in three individual cases. The checks were performed by using the DIAL technique, which also provided the identification of the 'black spots'.

### **Denmark**

No general guidelines on diffuse emissions requirements exist in Denmark. Requirements are specified in the individual environmental permits. The environmental permit of a tar and naphthalene distillation plant provides an example of the Danish requirements related to diffuse VOC emissions from equipment. The requirements have been stipulated according to the German VDI-guidelines and TA-Luft. The plant caused serious smell nuisance. The most smelling operations such as pumping had to be encapsulated and ventilated to a 60 m high stack but this wasn't sufficient to prevent the smell nuisance. Hence it was decided to reduce the diffuse emissions. The internal transport of raw materials, intermediate products and final products had to be converted to closed pipes to and from tanks equipped with ventilation and vapour recovery systems.

The permit contains:

- Emission limit values for the diffuse emission of hydrocarbons and hydrogen sulphide expressed

in mass flow per hour;

- Emission limit values for breathing losses from tanks expressed as mass flow per hour;
- Limit values for the concentration of odour, benzene, PAH, toluene and xylene in the surroundings. Diffuse emissions are measured by sampling in several points at a vertical level. Based on these results the concentration in the surroundings is calculated. It is recognised that the inaccuracy is significant. Calculations are therefore supplemented with subjective assessments of odour done by the competent authority.

An automatic optical method (DOAS) is used to measure the average concentration of benzene, hydrocarbon, xylene, toluene and naphthalene along the borders between the factory and the neighbourhood. The technique is used together with a wind gauge to detect a sudden increase in the emissions and to indicate a general increase in emissions due to insufficient maintenance. A sudden increase in emission can be correlated to the mode of operation of the plant e.g. filling of naphthalene. The investment cost of the measuring device amounted to 125,000 €.

### **Germany**

Requirements related to diffuse emissions are given in technical guidelines (VDI-Richtlinien):

- 1) Emission estimation:
  - a) VDI 3479 (1985- being updated): marketing Installation Tank Farms
  - b) VDI 3790 (1997/1999): Atmospheric emissions of landfill sites
  - c) VDI-4285: Measuring of diffuse emissions
  - d) VDI-4211/4210 Optical methods for diffuse emissions:
  - e) VDI-2440 (draft'99): Emission control of mineral oil refineries
- 2) Equipment
  - a) TA-Luft (1986): general requirements (art. 3.1.8, 3.3.4.4.1)
  - b) equipment guidelines are also given in VDI 3479/3790/2440(draft).

These guidelines provide a complete set of requirements, both for the emission estimation and equipment. The TA-Luft requirements are legally binding, whereas the VDI guidelines may be adopted in permit requirements. The main requirements of diffuse vapours or gaseous emissions from processing, conveying and decanting or storage of liquid organic substances are laid down in the TA Luft Nr. 3.1.8 for pumps, compressors, flanged joints or valves or sampling stations.

#### Pumping Units

When conveying volatile and inflammable liquid organic substances, low leakage pumps, e.g. with mechanical seals shall be used. For the pumping of organic liquids, that contain a certain concentration of toxic and persistent substances (TA Luft nr. 2.3 carcinogenics; nr. 3.1.7, para.7 persistent and accumulative) such as refinery intermediates with more than 5 % benzene particular effective emission control measures shall be applied for instance pumps with dual mechanical seals, canned motor pumps or magnetic-coupled pumps, closed drainage of liquid leakage losses or exhaustion of vapours or gaseous leakage losses and treatment of the collected waste gases.

#### Compressors

The barrier fluid of the compressors that compress gases containing particular toxic substances (TA Luft nr. 2.3, nr. 3.1.7 para 7) shall not be emitted into the atmosphere.

#### Flanged Joints

Flanged joints shall only be used if they are required for processing, safety or maintenance reasons; for particular hazardous substances (TA Luft nr. 2.3, nr. 3.1.7 class 1 and para.7) the flanged joints shall be equipped with high-grade seals.

#### Stop Valves

Spindle bonnets of the valves and gate valves shall be sealed by utilising bellows in connection with a downstream safety packing gland or by other equal means, if the handled liquid contains certain concentrations of hazardous substances such as mentioned under pumps.

#### Sampling systems

Sampling systems shall be encapsulated or equipped with stop valves that do not allow emissions except during sampling; the run-out sample shall be either fed back or completely collected.

#### Decanting

When decanting organic liquids special emission reduction measures shall be applied, i.e. vapour balancing systems or collect the vapour for the waste gas treatment installation.

Within the specific regulations of the TA Luft requirements for the mineral oil refineries for the storage of crude oil and mineral oil products have to be considered. Nr. 3.3.4.4 and 3.3.9. of the Technical Instruction contains requirements for the construction of the tank or measures during the loading of mineral oil products in order to control the fugitive emissions. For example, effective seals around the edges of floating-roof tanks, the use of reflective paints for tank coating or below level loading is required. Hydrocarbon vapours escaping during loading, storage or inspection processes have to be collected by means of vapour balancing or exhaust ventilation and conducted to a vapour recovery unit (VRU) or waste gas treatment plant.

### **Netherlands**

Emission estimation methods are prescribed in successive publications. The first publication was in 1983 [VROM'83] and consisted basically of the API-equations. Some minor modifications were made to reflect the Netherlands' situation. The methodology was updated at the beginning of the nineties [VROM'93] and the measuring based, EPA-method (stratification) was added. The methodology was formalised by adopting the methodology in the VOC agreement (ref. [KWS2000-18], [KWS2000-19]) and by the publication of the inter-provincial organisation in 1995 (ref. [IPO'95]). The VOC agreement (KWS 2000 programme) was an agreement between the relevant authorities and sector organisation and individual companies aiming at a reduction of 50% by the year 2000 (compared to 1980). A follow-up of the programme is actually being prepared aiming at a reduction of 80% by 2010 as compared to 1980. The province is the competent environmental authority for the concerned industries. It should be noticed that in practice the introduction of the prescribed method in the permit takes a long time for several reasons. E.g. using an updated method - offering a more accurate estimation - has a drawback within the context of agreement. Evaluation of the actual emission would require a recalculation of the target's baseline to bring it in accordance with the updated method, which could imply a new negotiation between the agreement partners.



The emphasis of VOC agreement was on the implementation of technical measures (floating roof storage tanks, vapour recovery, ...), which were defined per sector (e.g. large volume storage). After the commencement of the VOC programme in 1986 the environmental policy developed a more integrated approach towards the so-called target groups. The requirements and target of the VOC agreement are being incorporated in the environmental sector agreements (covering all environmental aspects).

### **Sweden**

No general guidelines on diffuse emissions requirements exist in Sweden. Requirements are specified in the individual environmental permits. The company applying for a permit must specify the technical requirements to be fulfilled, including those related to diffuse emissions. In order to give an impression of the requirements an example of the some main license requirements in the Sweden are given:

- Emission monitoring by remote sensing (DIAL) on a regular basis.
- LDAR (Leak detection and repair programme): At least twice a year a complete leak detection programme is carried out at the refineries. The leaks are divided into three groups depending on their magnitude. Leaks at alarm level (>900 ppm, as propane), leaks at medium level (500-900 ppm, as propane) and leaks at low level (100-500 ppm, as propane).
- Equipment: live-loading valves, bellow seals valves or equally effective valves in all services for naphtha or lighter products; valves equipped with an extra sealing ring.
- Compressors: all compressors vents (centrifugal and plunger) connected to the flare; special seals with oil sealing are to be used.
- External floating roof tanks: All tanks with external floating roof are equipped with secondary seals on the roof.
- Water treatment plants: use of equalising tanks. These tanks and also ballast water tanks are equipped with floating roofs. The temperature of the wastewater is controlled in order to reduce volatilisation and to secure the performance of the biological treatment; all separators have been covered.

### **United Kingdom**

The publication series 'Chief Inspector's Guidance Note' covers a variety of industrial processes. In order to give an impression of the requirements an example the main license requirements in the UK for on-shore oil production [ref. HMSO-S2a] is given:

- LDAR including portable monitors, recording of test results and regular (quarterly) reporting to the Inspector on the total VOC emission.
- Floating roof tanks with double seals are preferred for the storage of crude oil which may contain unstabilised gases.
- Tankers should be bottom loaded
- examples of BAT for equipment components are given:
  - low emission valve stem packing
  - use of balanced bellows type relief valves
  - minimising the number of flanged connections on pipelines and the use of high specification jointing materials
  - use of canned pumps or double seals on conventional pumps.

**United States of America**

The United States Environmental Protection Agency (EPA) issued a set of documents on the emission estimation and regulation of diffuse VOC emissions. The relevant documents are referenced in the various chapters of the report.

The keystone in the regulation of fugitive emission is the leak detection and repair programme (LDAR). LDAR is compulsory for the process industry. It consists of checking the components for leakage and of repairing the identified leaking components. The check on leakage is performed by using the EPA reference method 21 and has to be executed quarterly, semi-annually or annually.

The emissions of storage tanks that contain volatile products (vapour pressure  $\geq 76.7$  kPa) must be controlled by e.g. a vapour recovery system (95% reduction efficiency) or routed to a flare or process / fuel gas system. Storage tanks containing less volatile products can also control emission by a floating roof. For loading&unloading the following is required:

- a closed vent system that routes vapours to a control device (98 reduction efficiency or 20 ppmv exit concentration) or flare; or
- process piping that routes vapours to a process or fuel gas system; or
- vapour balancing system.

An initiative to simplify, clarify and improve the environmental regulation for the process industry commenced in 1995 and resulted in e.g. the Consolidated Federal Air Rule (CAR) for the Synthetic Organic Chemical Manufacturing Industry (SOCMI). There exists a feeling that the costs made to control fugitive emissions are not balanced with the environmental benefits. It is the intention of the draft regulation CAR to make the regulation more flexible, e.g. monitoring period may vary from 1 month to 2 years.

The EPA audits the plant's compliance by checking the LDAR database on a regular basis. Some states have established additional requirements to the federal regulation, which may make the overall regulation for a given plant more complex.

Diffuse VOC emissions are regulated in the USA for about 10-20 years. At present the EPA is evaluating the experience gained by these regulations.

## **5 Recommendations**

### **5.1 Introduction**

The review revealed that emission monitoring and reporting of the diffuse VOC emission to the competent authorities is not yet common practice in all EU member states. Also requirements with respect to diffuse emissions are either missing in permits or are prescribed in rather vague terms. Diffuse emissions have actually not yet caught the attention in all member states.

The IPPC Directive stipulates that the permit shall include emission limit values (amongst others for VOC). Emissions include diffuse sources in the installation into the air. The Directive also requires the operator to supply the competent authority with data required for checking compliance with the permit and requires the operator to inform the competent authority on the results of the monitoring. Results must also be made available to the Public.

This report may provide valuable input to the development of several BAT reference notes with respect to diffuse emissions. New measuring and low emissions techniques have emerged recently and are being applied successfully.

From these and their own observations the members of the IMPEL Working Group on diffuse emission draw the conclusion that a clear need exists for a licensing and enforcement guidance note with respect to diffuse emissions. Recommendations are given in the following paragraphs. An example of a diffuse emissions action plan is presented in annex D.

### **5.2 Identification of industries with potential relevant emissions**

In order to identify industries with relevant emissions it is recommended that:

- Process industry handling organic liquids or gases in large volumes are investigated for their VOC emissions. The tank terminals, petroleum refineries and the organic chemical industry are most concerned. Total VOC emissions are typically above of 10-100 ton/a per product unit. The organic compounds may include toxic and/or smelly substances.

### **5.3 Target or limit value**

The IPPC Directive stipulates that the permit conditions shall include emission limit value for pollutants. It is recommended to distinguish diffuse emissions separately. Examples are:

- setting a target on the total emissions; feasible reduction percentages depends on the initial situation.
- setting a target on the admissible number of leaking equipment. An example is given annex C.

The former requirement is of course more relevant for judgement of the environmental impact but exact quantification of the emission tends to be difficult. The latter requirement is easier to verify by enforcement authorities. Whatever the basis, a clear definition of the reference situation and limit is paramount. The emission calculation method and definition of a "leaking" component should be unambiguous.

## 5.4 Procedural measures

### Permitting

It is recommended that the environmental permit may include the following procedural measures:

- a leak detection and repair programme (LDAR) based on regular measuring of all accessible components, storage tanks and loading&unloading facilities; records of the detected leaks shall be maintained and reported regularly for checking of the compliance by the authorities.
- the monitoring results should be reported to the authorities [IPPC], e.g. the estimated total emission, the number of detected leaking components, the number of repaired/ replaced components and comparison with previous measurements.
- Maintenance should be geared to emission prevention.

### Enforcement

The enforcement authorities can verify the execution of a LDAR by:

- checking the existence and regular updating of component measurements.
- checking just repaired units by measuring at the components.

## 5.5 Emission estimation

### Permitting

Emission estimation of all atmospheric emissions, including diffuse VOC emissions is laid down in the IPPC, as well as reporting to the competent authorities. It is recommended that the licensing Authorities take the following requirements into account:

- Companies indicate their monitoring methods.
- All identified industries provide a report on the atmospheric emissions covering all diffuse emissions sources regularly, e.g. on an annual basis. The concerned company is able to specify the emission calculation method for every single source at request of the competent authority.
- The emission monitoring (and control) should be approved by the competent authorities. An example of an appropriate emission monitoring plan is presented in annex D.

As the emission estimation may vary by order of magnitude according to the calculation method used it is paramount that emission calculation methods are defined and that the definitions are unambiguous. A combination of different estimation methods is required to manage diffuse emissions (see paragraph 2.6). Also the monitoring and reporting frequency should be defined.

### Enforcement

The enforcement authorities can verify the emission estimation by checking:

- the methodologies used and the applied emission factors
- if the estimation covers all relevant emission sources
- the use of remote sensing techniques (especially DIAL).

## 5.6 Technical measures

### Permitting

The application of BAT is laid down in the IPPC. Examples of good practice are presented in annex B. It is recommended that the licensing Authorities should require:

- in case of new installations, companies to justify their technology choice in relation to BAT; in case of existing installations, companies should agree an action plan to upgrade the installation to BAT standards.
- the requirements for the storage, loading & unloading of gasoline (-like products) should be based on the VOC stage I Council Directive 94/63/EC.

Examples of technical measures that could be approved of are given in annex B.

### Enforcement

The enforcement authorities can verify the application of BAT by:

- checking the relevant documents (e.g. the ETBPP publications, German standards).
- site visit and checking of the installation and provisions (e.g. presence of cap or plug on open-ended lines) and proper operation (e.g. use of vapour recovery system or the execution of the repair programme)

It should be noticed that proper installation, operation and maintenance of the equipment are paramount. It has to be recognised that in all installations some components will leak to some extent. Notwithstanding that this situation is accepted, large uncontrolled leaks should not be acceptable. Different levels of response (e.g. immediate, short term, long term) could be defined for different leak sizes (see paragraph 4.2, Sweden for an example).

## 5.7 Non-compliance

In case of non-compliance the authority may decide to:

- have the plant audited resulting in additional permit conditions;
- initiate a leak detection and repair programme by a contractor at the cost of the plant.
- inform the public about the non-compliance.

It is emphasised that the permit requirements should be 'measurable' in order to provide unambiguous proof of compliance or non-compliance. Examples of measurable requirements related to diffuse emissions are:

- the annual emission reporting with a break-down of all emission sources;
- the presence and operation of technical measures (e.g. vapour recovery system);
- a leak detection programme by measurements through the check of the measuring data;
- a target on the admissible number of leaking components.

## **5.8 Supporting activities**

Supporting activities may be considered by the authorities, such as:

- encourage and endorse an information & training programme in regions where the subject is relatively new (targeting both companies and licensing & enforcing bodies)
- establishing national guidelines
- performing an eco-audit of the industrial plant
- establishing a helpdesk to assist both companies and licensing & enforcing bodies .

It is recommended that the IMPEL organisation set up an EU wide information exchange programme on the licensing and enforcement practice in relation to diffuse VOC emissions. Such programme could include a bench marking on subjects like estimation methods and measures; the latter (measures) preferably with a clear link to the BREF notes programme. The exchange programme could be set up within the IMPEL organisation.

## Literature and web sites

5EAP	Fifth Environmental Action Programme of the EU.
API-2514A	Atmospheric hydrocarbon emissions from marine vessel transfer operations, second edition; API Publ 2514 A; 1981 (reaffirmed 1992).
API-2516	Evaporation loss from low-pressure tanks; API Bull 2516; March 1962 (reaffirmed August 1993).
API-2517	Evaporation loss from external floating-roof tanks; API Publ 2517, first edition; 1993.
API-2518	Evaporation loss from fixed -roof tanks; API Publ 2518, first edition; June 1962.
API-2519	Evaporation loss from internal floating-roof tanks; API Publ 2519, first edition; 1993.
API-4588	Development of fugitive emission factors and emission profiles for petroleum marketing terminals, volume 1; API Publ 4588; 1993.
API-45881	Development of fugitive emission factors and emission profiles for petroleum marketing terminals, volume 2; API Publ 45881; 1993.
API-4653	Fugitive Emission Factors for Crude Oil and Product Pipeline Facilities; API Publ 4653, June 1997.
API-manual	API Manual of petroleum measurements standards: chapter 19 - Evaporative loss measurement; API, regularly updated.
AU'91	Verordnung des Bundesministers für wirtschaftliche Angelegenheiten über die Ausstattung gewerblicher Betriebsanlagen mit Gaspendelleitungen für ortsfeste Kraftstoffbehälter (Vapour balance for loading from storage tanks to trucks, ships and trains); Bundesgesetzblatt der Republik Österreich Nr. 558 vom 31 Oktober 1991.
AU'92	Verordnung des Bundesministers für wirtschaftliche Angelegenheiten über die Ausstattung von Tankstellen mit Gaspendelleitungen (Vapour balance during refuelling); Bundesgesetzblatt der Republik Österreich Nr. 793 vom 17. September 1992.
AU'95	Verordnung des Bundesministers für wirtschaftliche Angelegenheiten, mit der die Verordnung über die Ausstattung gewerblicher Betriebsanlagen mit Gaspendelleitungen für ortsfeste Kraftstoffbehälter geändert wird (Vapour balance for loading from storage tanks to trucks, ships and trains); Bundesgesetzblatt der Republik Österreich Nr. 904 vom 29. Dezember 1995
BREF'00	Draft BAT reference document on mineral oil refineries; 18 February 2000
Borealis	To Whom It May Concern: Leak detection with dogs; Borealis 1997-04-10.
CAR	Consolidated Federal Air Rule for the Synthetic Organic Chemical Manufacturing Industry; Federal Register, 28 October 1998.
Concawe'87	Cost-effectiveness of hydrocarbon emission controls in refineries from crude oil receipt to product dispatch; Concawe report 87/52; 1987.
Concawe'95	95/52 VOC emissions from external floating roof tanks: comparison of remote measurements by laser with calculation methods; concawe 95/52.
Corinair'94	Corinair 94, summary report; report to the European Environment Agency from the European Topic Centre on Air Emissions; 10 April 1997.
CRI '97	Improved Consistency of reporting in the CRI, a consultation document; Environment Agency; 12 November 1997.

ECVM'98	VOC emission monitoring, presentation at ECVM meeting 13 <sup>th</sup> Jan.1998; J. Andersson (Borealis).
EEA'96	Atmospheric emission inventory Guidebook; EMEP/CORINAIR; Copenhagen, 1996.
EEA'98	Europe's Environment: The second assessment; European Environment Agency, 1998.
EIIP	EIIP-Volume II, chapter 4 – Preferred methods for estimating emissions; 29 November 1996.
EPA -AP42	Compilation of Air Pollutant Emission Factors, AP 42 – Section 7.1 Organic liquid storage tanks; US EPA; September 1997 (updated regularly).
EPA'95	Protocol for equipment leak emission estimates; EPA –453/R-95-017; US EPA; November 1995. – The protocol includes the measuring protocol 'Reference Method 21.
EPA-AP42doc	Emission factor documentation for AP-42 Section 7,1 Organic liquid storage tanks, final report; Midwest Research Institute (MRI) No. 4604-03; September 1997.
ETBPP-CG14	Detecting and reducing fugitive emissions saves money, a good practice case study at Shell's Stanlow ethylbenzene unit; Environmental Technology Best Practice Programme.
ETBPP-GG71	Cost-effective reduction of fugitive solvent emissions; Environmental Technology Best Practice Programme; March 1997.
HMSO-IPR	Environmental Protection Act 1990, industry sector guidance note IPR 4, Chemical Industry Sector; Chief Inspector's Guidance to inspectors, 1991.
HMSO-S2a	Processes subject to integrated pollution control, Petroleum processes: on-shore oil production; Chief Inspector's Guidance note, Series 2 (S2 1.11), November 1995.
HMSO-S2b	Processes subject to integrated pollution control, Petroleum processes: oil refining and associated processes; Chief Inspector's Guidance note, Series 2 (S2 1.10), November 1995.
Hund	Statoil publication.
IMPEL	Amended proposal for a European Parliament and Council recommendation providing for minimum criteria for environmental inspections in the member states; COM(1999) 652 final; Brussels, 03.12.1999.
IPO'95	Handreiking lekverliezen, beoordeling van meet- en beheersprogramma's; IPO; The Hague, April 1995
IPPC	Council Directive 96/61/EC of 26 September 1996.
IPPC'99	Draft reference document on monitoring; Technical Working Group on monitoring of the European BAT reference project; January 1999.
IVL'95	Measurements of industrial fugitive emissions by the FTIR-tracer method (FTM); IVL – Institutet för vatten- och luftvårdsforskning/Swedish environmental research institute; Report nr. B1214, January 1996.
Janson'99	Swedish BREF on refineries; B. Janson, Swedish Environmental Protection Agency; 1999.
KWS2000-18	Diffuse procesbronnen, Raffinaderijen&terminals; KWS2000, Factsheet 18; The Hague, December 1994.
KWS2000-19	Lekverliezen, chemische industrie; KWS2000, Factsheet 19;The Hague, December 1994.



LRTAP-VOC	Protocol to the 1979 convention on long-range transboundary air pollution concerning the control of emissions of volatile organic compounds or their transboundary fluxes; UN-ECE, 1991.
MARPOL	MARPOL 73/78, the International Convention of Pollution from Ships, 1973 as modified by the Protocol of 1978 ; IMO.
NILU	Company documentation on tracer gas; Norwegian Institute for Air Research NILU.
NPL	Company documentation on DIAL; the National Physics Laboratories, UK.
NW'97a	Optische Fernmessverfahren – ein Instrument zur Abschätzung von Luftverunreinigenden Emissionen aus diffusen Quellen; G. Bröker&A. Gärtner; Jahresbericht'97- landesumweltamt Nordrhein-Westfalen; 1997.
NW'97b	Effiziente Kohlenwasserstoff-Emissionsminderung während der Rohöltankreinigung ist technisch realisierbar; M. Wichert; Jahresbericht'97- landesumweltamt Nordrhein-Westfalen; 1997.
OPSIS	Company documentation on DOAS; OPSIS, Sweden.
SLRS	Company documentation of Schelde Leak Repairs Specam, the Netherlands.
TA Luft	Erste Allgemeine Verwaltungsvorschrift zum Bundes-Immissionsschutzgesetz (Technische Anleitung zur Reinhaltung der Luft - TALuft), Nach § 48 des Bundes-Immissionsschutzgesetzes (BimSchG) vom 15. März 1974 (BGBl. IS. 721); 1986.
The Sniffers	Company documentation on sniffer dogs; The Sniffers, Belgium.
TNO'98	Development and demonstration of a method to monitor the effects of measures to reduce VOC emissions in the EU; LIFE & VROM; TNO-MEP report no. R 98/028, January 1998.
UN-ECE'99	Press Release ECE/ENV/99/11 on the Protocol to Abate Acidification, Eutrophication and Ground-level Ozone; Geneva, 24 November 1999
UNITAR'95	Estimating environmental releases for facility PRTR reporting, a guide to methods; The Hamshire Research Institute for UN Institute for training and research, October 1995.
VDI'98	Second European fugitive emission conference – controlling leaks from valves, pumps and flanges – 8 <sup>th</sup> and 9 <sup>th</sup> September 1998 at Düsseldorf/Neuss by VDI-Gesellschaft Entwicklung Konstruktion Vertrieb/European Sealing Association (selection): Tackling fugitive emissions: a European Perspective; A.M. Farmer. Legal requirements in relation to fugitive emissions in Germany; W. Drechsler. A perspective of the US-EPA's experience with equipment leak regulations; R. Colyer (US-EPA). Control of fugitive emissions – activities and attitudes of the chemical and petrochemical industry; K. Herrmann&H.-J. Siegle (BASF). Determination of emissions of flange joints in a chemical plant; K. Kanschik&H. Schmidt-Traub (Dortmund University). Measurement of fugitive emissions: the different methods applied to industrial valves; Y. Birembaut, T. Ledauphin & V. Masi (CETIM). Screening vs. Bagging for leak control and monitoring; Th. Kittleman.

VDI'98	VDI-Berichte 1441: 2 <sup>nd</sup> European fugitive emissions conference – Controlling leaks from valves, pumps and flanges; VDI-Gesellschaft Entwicklung Konstruktion Vertrieb – Conference Düsseldorf/Neuss, September 8 <sup>th</sup> and 9 <sup>th</sup> 1998.
VDI-2440	Emissionsminderung Mineralölraffinerien/Emission control mineral oil refineries (Entwurf/draft); VDI, July 1999.
VDI-3479	Emissionsverminderung Mineralölvertriebsläger/ Emission control, Marketing installation tank farms ; VDI, July 1985 (revision expected!).
VDI-3790	Emissionen von Gasen, Gerüchen und Stäuben aus diffusen Quellendeponien (Entwurf/draft); VDI, March 1997.
VDI-4211/4210	Optische Fernmessverfahren für diffuse Emissionen; VDI.
VDI-4285	Messverfahren zur Ermittlung diffuser Emissionen; VDI.
VOC'93	'VOC Assessment and Evaluation' Workshop proceedings – 26-28 January 1993, Amersfoort The Netherlands (selection): Diffusion experiments to trace VOC leakages from refineries and petrochemical plants; NILU (Norwegian Institute for Air Research). Legislation and regulation policy on VOC in Austria; Austrian Federal Environmental Agency.
VOC'97	'Solution for industrial fugitive emissions' Conference - 20 <sup>th</sup> November 1997 at Strand Hotel, London (selection): High performance sealing technology; James Walker Ltd. Meeting the legal issues; Simmons & Simmons. Maximising the tools and techniques for detecting fugitive leaks; Symonds group Ltd. Environmental management of valves used in the petro-chemical plants; BP. Innovative sealing technology; Ferrofluidics Co.&Sterling Hydraulics Ltd.
VOC'98	'Volatile Organic Compounds' Conference - 9 <sup>th</sup> &10 <sup>th</sup> March at Forte Posthouse Bloomsbury Hotel, London (selection): VOC-measurement work&standards (CEN); AEA Netcen. Remote sensing techniques for gas detection, air pollution and direct fugitive loss monitoring; Centre for optical and environmental metrology – National Physical Laboratory.
VOC'99	'Volatile Organic Compounds' Conference - 27 <sup>th</sup> &28 <sup>th</sup> January 1999 at Mayfair Conference Centre, London (selection): Effectively measuring and monitoring emissions; Dr. R. Brown of Resource & Environmental Consultants Ltd. Cost effective reduction of fugitive emissions; Environmental Technology Best Practice Programme. Estimation and measurement of VOC emissions in the petroleum industry; Shell. Industrial Application of a novel biological technique for VOC reduction; A. Murphy.
VROM'83	Handbook of Emission Factors, part 2, industrial sources; VROM, The Hague, 1983.
VROM'93	Emissiefactoren, Lekverliezen van apparaten en verliezen bij op- en overslag; VROM, PublicatierEEKS Emissieregistratie nr. 8; The Hague, April 1993.
VROM'96	Estimating environmental releases from diffuse sources, a guide to methods; C.W.A.. Evers&P.F.J. van der Most; VROM; The Hague, March 1996.

VROM'98 Internal memorandum of Heslinga to Evers; "Notitie bij drempelwaarden tbv artikel"; 22 May 1998.

**Web sites (<http://>)**

API	<a href="http://www.api.org">www.api.org</a>
Austrian environmental legislation (Austrian Chancellery)	<a href="http://www.ris.bka.gv.at/plweb/doku/bgbl.html">www.ris.bka.gv.at/plweb/doku/bgbl.html</a>
Belgian/Flemish environmental legislation	<a href="http://www2.vito.be/navigator/default.asp">www2.vito.be/navigator/default.asp</a>
Concawe	<a href="http://www.concawe.be/reports">www.concawe.be/reports</a>
Corinair	<a href="http://www.aeat.co.uk/netcen/corinair/corinair.html">www.aeat.co.uk/netcen/corinair/corinair.html</a>
EEA (e.g. Atmospheric emission inventory guidebook)	<a href="http://www.eea.eu.int">www.eea.eu.int</a>
ETBPP	<a href="http://etbpp.netgates.co.uk">etbpp.netgates.co.uk</a>
Euro-BAT	<a href="http://eippcb.jrc.es">eippcb.jrc.es</a>
IMO	<a href="http://www.imo.org">www.imo.org</a>
IPPC	<a href="http://europa.eu.int/eur-lex">europa.eu.int/eur-lex</a>
OSPAR (PARCOM)	<a href="http://www.ospar.org">www.ospar.org</a>
TA Luft	<a href="http://www.umweltrecht.de/recht/luft/bimschg/vwv/ta_luft">www.umweltrecht.de/recht/luft/bimschg/vwv/ta_luft</a>
The Stationary Office (e.g. The chief Inspector's guidance series)	<a href="http://www.tso-online.co.uk">www.tso-online.co.uk</a>
US EPA -AP42	<a href="http://www.epa.gov/ttn/chief">www.epa.gov/ttn/chief</a>
US EPA-CAR	<a href="http://www.epa.gov/ttn/uatw/car/car_rdpq.html">www.epa.gov/ttn/uatw/car/car_rdpq.html</a>
US EPA-general	<a href="http://www.epa.gov">www.epa.gov</a>
US South Coast Air Quality Management District	<a href="http://www.aqmd.gov">www.aqmd.gov</a>
VDI	<a href="http://www.vdi.de">www.vdi.de</a>

## Glossary and extract of IPPC Directive

API	American Petroleum Institute.
BAT	Best Available Techniques
BREF	BAT reference documents.
CAR	Consolidated Federal Air Rule
CONCAWE	European Oil companies organisation for environment, health and safety.
CORINAIR	EEA's atmospheric emissions inventory.
DOAS	Differential optical absorption spectroscopy
DIAL	Differential Absorption LIDAR
ECE	Economic Commission for Europe.
EEA	European Environment Agency.
EPA	US Environmental Protection Agency.
ETBPP	Environmental Technology Best Practice Programme.
EU	European Union
FTIR	Fourier transfer infrared
IBC	Intermediate Bulk Container
IMO	International Maritime Organisation.
IMPEL	European organisation of Inspectorate for the environment.
IPO	The organisation of the Netherlands' Provinces.
IPPC	Integrated pollution prevention control (EU directive 96/61/EC).
IR	Infra red.
LASER	Light Amplification by Stimulated Emission of Radiation
LDAR	Leak detection and repair (checking of process components for leakage and repairing of identified leaking components); LDAR is compulsory in the USA for the process industry (detection according to EPA reference method 21 quarterly or annually for all components).
LIDAR	Light Detection and Ranging
NMVOG	Non-Methane VOC.
OSPAR (PARCOM)	The Convention for the Protection of the Marine Environment of the North-East Atlantic (the "OSPAR Convention" it replaces the Oslo and Paris Conventions)
Pegged emission	Emission that corresponds with the screening value beyond the upper limit measured by the portable screening device
ppmv	unit of parts per million by volume
Screening value	A measure of the concentration of leaking compounds in the ambient air that provides an indication of the leak rate from an equipment piece (concentration within 1 cm of the seal as ppmv)
SOCMI	Synthetic Organic Compound Manufacturing Industry
UK	United Kingdom of Great Britain and Northern Ireland.
UV	Ultra violet.
VOC	Volatile Organic Compounds: any organic compound having at 293.15 K a vapour pressure of 0.01 kPa or more, or having a corresponding volatility under the particular conditions of use (VOC as defined by EC Directive 1999/13/EC of 11 March 1999, Article 2 sub 17).

Diffuse emissions	All emissions that are not released via specific emission points (stacks, etc.); e.g. leakage from equipment (= fugitive emissions), loading&unloading operations, evaporation losses from storage tanks and waste water treatment; excluded are emissions resulting from the use of solvents which are regulated by the EC Directive 1999/13/EC.
Fugitive emissions	All emissions that are released as leakage from equipment, e.g. product leaking at seals (= part of diffuse emissions)
VROM	The Netherlands' Ministry of Housing, Spatial planning and the Environment.
VRU	Vapour recovery unit.

## Extract of IPPC Directive

### Article 2

For the purposes of this Directive:

#### Definitions

1. **'substance'** shall mean any chemical element and its compounds, with the exception of radioactive substances within the meaning of Directive 80/836/Euratom (8) and genetically modified organisms within the meaning of Directive 90/219/EEC (9) and Directive 90/220/EEC (10);

5. **'emission'** shall mean the direct or indirect release of substances, vibrations, heat or noise from individual or diffuse sources in the installation into the air, water or land;

11. **'best available techniques'** shall mean the most effective and advanced stage in the development of activities and their methods of operation which indicate the practical suitability of particular techniques for providing in principle the basis for emission limit values designed to prevent and, where that is not practicable, generally to reduce emissions and the impact on the environment as a whole:

- 'techniques' shall include both the technology used and the way in which the installation is designed, built, maintained, operated and decommissioned,
- 'available' techniques shall mean those developed on a scale which allows implementation in the relevant industrial sector, under economically and technically viable conditions, taking into consideration the costs and advantages, whether or not the techniques are used or produced inside the Member State in question, as long as they are reasonably accessible to the operator,
- 'best' shall mean most effective in achieving a high general level of protection of the environment as a whole.

In determining the best available techniques, special consideration should be given to the items listed in Annex IV.

### Article 9 -

#### Conditions of the permit

3. The permit shall include emission limit values for pollutants, in particular, those listed in in Annex III, likely to be emitted from the installation concerned in significant quantities, having regard to their nature and their potential to transfer pollution from one medium to another (water, air and land). If necessary, the permit shall include appropriate requirements ensuring protection of the soil and ground water and measures concerning the management of waste generated by the installation. Where appropriate, limit values may be supplemented or replaced by equivalent parameters or technical measures.

For installations under subheading 6.6 in Annex I<sup>1</sup>, emission limit values laid down in accordance with this paragraph shall take into account practical considerations appropriate to these categories of installation.

5. The permit shall contain suitable release monitoring requirements, specifying measurement methodology and frequency, evaluation procedure and an obligation to supply the competent authority with data required for checking compliance with the permit.

For installations under subheading 6.6 in Annex I<sup>2</sup>, the measures referred to in this paragraph may take account of costs and benefits.

<sup>1</sup> Installations for the intensive rearing of poultry or pigs

**Article 14-** Member States shall take the necessary measures to ensure that:

*Compliance with permit conditions*

- the conditions of the permit are complied with by the operator when operating the installation,
- the operator regularly informs the competent authority of the results of the monitoring of releases and without delay of any incident or accident significantly affecting the environment,
- operators of installations afford the representatives of the competent authority all necessary assistance to enable them to carry out any inspections within the installation, to take samples and to gather any information necessary for the performance of their duties for the purposes of this Directive.

**Article 15**

*Access to information and public participation in the permit procedure*

2. The results of monitoring of releases as required under the permit conditions referred to in Article 9 and held by the competent authority must be made available to the public.

3. An inventory of the principal emissions and sources responsible shall be published every three years by the Commission on the basis of the data supplied by the Member States. The Commission shall establish the format and particulars needed for the transmission of information in accordance with the procedure laid down in Article 19. In accordance with the same procedure, the Commission may propose measures to ensure inter-comparability and complementarity between data concerning the inventory of emissions referred to in the first subparagraph and data from other registers and sources of data on emissions.

**ANNEX III -**

*indicative list of the main polluting substances to be taken into account if they are relevant for fixing emission limit values*

AIR

1. Sulphur dioxide and other sulphur compounds
2. Oxides of nitrogen and other nitrogen compounds
3. Carbon monoxide
4. Volatile organic compounds
5. Metals and their compounds
6. Dust
7. Asbestos (suspended particulates, fibres)
8. Chlorine and its compounds
9. Fluorine and its compounds
10. Arsenic and its compounds
11. Cyanides
12. Substances and preparations which have been proved to possess carcinogenic or mutagenic properties or properties which may affect reproduction via the air
13. Polychlorinated dibenzodioxins and polychlorinated dibenzofurans

## **Annex A: Contact details**

The project was supported by a working group. The working group was set up to serve the following purposes:

- Ensure good utilisation of existing knowledge through input of information and discussions
- Ensure that the methodologies and approaches of the consultants are those best suited
- Overlook and take part in the progress of the work
- Give approval to methodology during the work, to ensure that the final result is acceptable
- Review the draft report

The inventory survey commenced by contacting the national IMPEL co-ordinators. In most cases the survey was completed by contacting other national experts.

The Consultant has benefited from the support of a large number of individuals in conducting the study. In particular the Consultant would like to thank Mr. Klaas Waterlander and the members of the working group, Mr. Philip Francois, Mr. Theo de Gelder, Mr. Jørn Hansen, Mr. Bo Jansson, Mr. Ken Ledgerwood, Mr. Wilhelm Muchitsch and Mr. Dieter Wilke for their direct assistance in providing valuable material and in the design of the report. The Consultant would also like to thank Mr. Enno de Vries of Shell Chemie Nederland and Mr. Dop Schoen of Exxon Chemical Holland for sharing their experiences in controlling diffuse VOC emissions with the members of the Working Group.

The IMPEL network has proved to be very useful in conducting the EU wide survey. Although the Consultants have experienced certain difficulties obtaining information from some EU member states, most have been helpful.

Valuable input was made by the subconsultants. Mr. Frans van Kogelenberg of Schelde Leak Repairs Specam B.V. (NL) assisted in the EU wide review and shared his outstanding experience of monitoring diffuse VOC emissions (LDAR). Mr. Philip Mellen of Cowi Consulting Engineers and Planners A.S. (DK) co-operated in the design of the questionnaire and assisted in the EU wide review.

The contact details of the contacted persons are provided in this annex. The details are presented in three groups:

1. Working Group and Consultants
2. IMPEL group
3. others.



## Working Group members

<b>chairman</b>	Mr. Klaas Waterlander	Inspectie Milieuhygiëne Oost Postbus 60083 NL-6800 JB Arnhem e-mail: <a href="mailto:klaas.waterlander@imh-o.dgm.minvrom.nl">klaas.waterlander@imh-o.dgm.minvrom.nl</a>	phone: 00 31 26 3528400 fax: 00 31 26 3528455
<b>member</b>	Mr. Filip Francois	AMINAL Afdeling Milieuspectie Koning Albert 2-laan 2020 B-1000 Brussel e-mail: <a href="mailto:filip.francois@lin.vlaanderen.be">filip.francois@lin.vlaanderen.be</a>	phone: 00 32 2 5538192 fax: 00 32 2 5538085
<b>member</b>	Mr. Theo de Gelder	Inspectie Milieuhygiëne ZuidWest Postbus 5312 NL-2280 HH Rijswijk e-mail: <a href="mailto:Theo.DeGelder@imh-zeeland.dgm.minvrom.nl">Theo.DeGelder@imh-zeeland.dgm.minvrom.nl</a>	phone: 00 31 118 687219 / 070 3985855 fax: 00 31 118 638245
<b>member</b>	Mr. Jørn L. Hansen	Danish Environment Protection Agency Strandgade 29 DK-1401 Copenhagen e-mail: <a href="mailto:jlh@mst.dk">jlh@mst.dk</a>	phone: 00 45 32 660100 fax: 00 45 32 660479
<b>member</b>	Mr. Bo Jansson	Swedish Environmental Protection Agency Naturvårdsverket SE-106 48 Stockholm e-mail: <a href="mailto:Bo.Jansson@environ.se">Bo.Jansson@environ.se</a>	phone: 00 46 (8) 698 11 73 fax: 00 46 (8) 698 12 22
<b>member</b>	Mr. Ken Ledgerwood	Environment and Heritage Service Calvert House Castle Place BT1 1FY Belfast e-mail: <a href="mailto:ken.ledgerwood@doeni.gov.uk">ken.ledgerwood@doeni.gov.uk</a>	phone: 00 44 2890 254754 fax: 00 44 2890 254700
<b>member</b>	Mr. Wilhelm Muchitsch	Bundesministerium für Wirtschaft und Arbeit Department III 6 Stubenring 1 A-1010 Wien e-mail: <a href="mailto:wilhelm.muchitsch@bmwa.gv.at">wilhelm.muchitsch@bmwa.gv.at</a>	phone: 00 43 1 711005501 fax: 00 43 1 7142718

## Annex A - Contact details

<b>member</b> (deputy)	Mr. Marc Vanthienen	AMINAL Afdeling Milieuspectie Waaistraat 1, bus 2B B-3000 Leuven e-mail: <a href="mailto:marc.vanthienen@lin.vlaanderen.be">marc.vanthienen@lin.vlaanderen.be</a>	phone: 00 32 16 211159 fax: 00 32 16 211151
<b>member</b>	Mr. Dieter Wilke	Ministerium für Umwelt, Raumordnung und Landwirtschaft Nordrhein Westfalen Bezirksregierung Köln D-50606 50667 Köln	phone: 00 49 221 1472664 fax: 00 49 221 1472469

**Project team**

<b>project</b> leader	Mr. Reinoud van der Auweraert	Tebodin P.O. box 16029 NL-2500 BA The Hague e-mail: <a href="mailto:r.vanderauweraert@tebodin.nl">r.vanderauweraert@tebodin.nl</a>	phone: 00 31 70 3480204 fax: 00 31 70 3480591
<b>member</b>	Mr. Frans van Kogelenberg	Schelde Leak Repairs Specam P.O. box 37 NL-4380 AA Vlissingen e-mail: <a href="mailto:teaminc@zeelandnet.nl">teaminc@zeelandnet.nl</a>	phone: 00 31 118 485809 fax: 00 31 118 485886
<b>member</b>	Mrs. Colinda Land	Tebodin P.O. box 16029 NL-2500 BA The Hague e-mail: <a href="mailto:c.land@tebodin.nl">c.land@tebodin.nl</a>	phone: 00 31 70 3480335 fax: 00 31 70 3480591
<b>member</b>	Mr. Philip Mellen	Cowi A.S. Parallevej 15 DK-2800 Lyngby e-mail: <a href="mailto:pcm@cowi.dk">pcm@cowi.dk</a>	phone: 00 45 4597 2211 fax: 00 45 4597 2212

**IMPEL contacts*****IMPEL secretariat***

<b>Co-ordinator</b>	Mr. Terry Shears	DG XI BU-5, 4/44 Rue de la Loi - Wetstraat 200 B-1049 Brussels e-mail: <a href="mailto:terence.shears@dg11.cec.be">terence.shears@dg11.cec.be</a>	phone: 00 32 (2) 2994383 fax: 00 32 (2) 2991070
---------------------	------------------	---	--

**secretary** Mrs. Roberta Salerno      DG XI      phone: 00 32 (2) 2992349  
 BU-5, 4/146      fax: 00 32 (2) 2991070  
 Rue de la Loi - Wetstraat 200  
 B-1049 Brussels  
 e-mail: [roberta.salerno@dg11.cec.be](mailto:roberta.salerno@dg11.cec.be)

### ***IMPEL → secretariat at the European Commission***

**Belgium** Mr. Georges Kremlis      DG XI      phone: 00 32 (2) 2966526  
 BU-5, 4/11      fax: 00 32 (2) 2991070  
 Rue de la Loi - Wetstraat 200  
 B-1049 Brussels  
 e-mail: [georges.kremlis@dg11.cec.be](mailto:georges.kremlis@dg11.cec.be)

### ***IMPEL → national co-ordinators***

**Austria** Mrs. Elisabeth Motycka      Federal Ministry of Environment,      phone: 00 43 (1) 51522 1628  
 Youth and Family Affairs      fax: 00 43 (1) 51522 7626  
 Department of International  
 and EU Affairs  
 Stubenbastei 5  
 A-1010 Vienna  
 e-mail: [elisabeth.motycka@bmu.gv.at](mailto:elisabeth.motycka@bmu.gv.at)

**Belgium** Mr. Jean Pierre Janssens      Brussels Institute for Environmental      phone: 00 32 (2) 7757501  
 Management      fax: 00 32 (2) 7757505  
 Division of Inspection and  
 Surveillance  
 Gulledele 100  
 e-mail: [jjp@ibgebim.be](mailto:jjp@ibgebim.be)

**Denmark** Mr. Gudmund Nielsen      Danish EPA      phone: 00 45 (32) 660100  
 Strandgade 29      fax: 00 45 (32) 660479  
 DK-1401 Copenhagen  
 e-mail: [gni@mst.dk](mailto:gni@mst.dk)

**Finland** Mr. Markku Hietamäki      Ministry of the Environment      phone: 00 358 (9) 1991 9703  
 PO Box 380      fax: 00 358 (9) 1991 9453  
 FIN-00131 Helsinki  
 e-mail: [markku.hietamaki@vyh.fi](mailto:markku.hietamaki@vyh.fi)

**France** Mrs. Marie-Claude Dupuis      Ministry of the Environment      phone: 00 33 (1) 4219 1440  
 DPPR/SEI      fax: 00 33 (1) 42191467  
 Av de Segur 20  
 F-75302 Paris 07 SP  
 e-mail: [Marie-claude.dupuis@environnement.gouv.fr](mailto:Marie-claude.dupuis@environnement.gouv.fr)

## Annex A - Contact details

<b>Germany</b>	Mr. Eckart Meyer-Rutz	Bundesministerium für Umwelt, Naturschutz und Reaktorsicherheit Kennedyallee 5 D-53175 Bonn e-mail: <a href="mailto:meyer.eckart@bmu.de">meyer.eckart@bmu.de</a>	phone: 00 49 (228) 305 2252 fax: 00 49 (228) 305 2225
<b>Greece</b>	Mr. Epaminondas Toleris	Ministry of Environment, Physical Planning and Public Works Environmental Planning Division 147 Patisision Street GR-11251 Athens e-mail: -	phone: 00 30 (1) 8623020 fax: 00 30 (1) 8562024
<b>Ireland</b>	Mr. Bill McCumiskey	Environmental Protection Agency Johnstown Castle Estate PO Box 3000 IR-Co. Wexford e-mail: <a href="mailto:c.malone@epa.ie">c.malone@epa.ie</a>	phone: 00 353 (53) 60600 fax: 00 353 (53) 60696
<b>Italy</b>	Mr. Francesco La Camera	Ministry of the Environment Via della Ferratella in Laterano 33 I-00184 Rome e-mail: <a href="mailto:f.lacamera@labnet.cnuce.cnr.it">f.lacamera@labnet.cnuce.cnr.it</a>	phone: 00 39 (06) 70362279 fax: 00 39 (06) 70362274
<b>Luxembourg</b>	Mr. Théo Weber	Administration for the Environment 1 Rue Bender L-1229 Luxembourg e-mail: <a href="mailto:weber@aev.etat.lu">weber@aev.etat.lu</a>	phone: 00 352 4056 56244 fax: 00 352 485078
<b>Netherlands</b>	Mrs. Annelie Kohl	Ministry of Housing, Spatial Planning and the Environment PO Box NL-2500 The Hague e-mail <a href="mailto:annelie.kohl@da.dgm.minvrom.nl">annelie.kohl@da.dgm.minvrom.nl</a>	phone: 00 31 (70) 3393939 fax: 00 31 (70) 3391300
<b>Portugal</b>	Mrs. Ana Magro e Silva	Inspectorate General for the Environment Rua da Murgueira - Zambujal, Apartado 7585 Alfragide P-2720 Amadora e-mail: <a href="mailto:asr@dga.min-amb.pt">asr@dga.min-amb.pt</a>	phone: 00 351 (1) 4728241 fax: 00 351 (1) 4728389
<b>Spain</b>	Mr. José Luis Obesso Gomez	Ministry of Environment, Plaza San Juan de la Cruz S/N E-28071 Madrid e-mail: <a href="mailto:jluis.obesso@sgeaas.mma.es">jluis.obesso@sgeaas.mma.es</a>	phone: 00 34 (91) 5976072 fax: 00 34 (91) 5975816

<b>Sweden</b>	Mrs. Inga Birgitta Larsson	Swedish Environmental Protection Agency Naturvårdsverket SE-106 48 Stockholm e-mail: <a href="mailto:ingabirgitta.larsson@environ.se">ingabirgitta.larsson@environ.se</a>	phone: 00 46 (8) 698 11 42 fax: 00 46 (8) 698 12 22
<b>United Kingdom</b>	Mrs. Caroline Hager	Environment Agency, Rio House Waterside Drive, Aztec West, Almondsbury BS32 4UD Bristol	phone: 00 44 (1454) 624 400 fax: 00 44 (1454) 624 319

### Other contacted national experts

(remark: not all contact details have been retrieved)

<b>Belgium</b>	Mr. Rudi van Balen	The Sniffers	phone: 00 32 14318888 <a href="mailto:the.sniffers@ping.be">the.sniffers@ping.be</a>
<b>Denmark</b>	Knud Erik Gormose <i>Environmental officer</i> <i>(refinery, tank terminal, organic chemicals industry)</i>	Vestsjælland Amt <a href="mailto:keg@vestamt.dk">keg@vestamt.dk</a>	phone: 00 45 57872533,
	Elle Maria Bisschop-Larsen <i>Environmental officer</i> <i>(Organic chemical industry Hazardous waste treatment)</i>	Fynn Amt	phone: 00 45 65561564
	Connie Schmidt <i>Environmental officer</i> <i>(Organic chemicals industry)</i>	Ringkjøbing Amt	phone: 00 45 96753617
	Jørgen Jørgensen <i>Civil Engineer (Organic chemicals industry)</i>	Vejle County	phone: 00 45 7835333
<b>Finland</b>	Ms. Anneli Karjalainen <i>(Senior Advisor)</i>	Ministry of Environment, Environmental Protection Department	phone: 00 358-9-19911 <a href="mailto:anneli.karjalainen@vyh.fi">anneli.karjalainen@vyh.fi</a>
<b>France</b>	Mrs. Bonneville		phone: 00 33 142191444
	Mr. R. Bouscaren <i>(Director)</i>	Citepa	
	Mr. J.M. Leygue <i>(Director)</i>	ECS	

## Annex A - Contact details

<b>Greece</b>	Mr Kafariss/ Mr. Kaludis		phone: 00 30 18652493
<b>Ireland</b>	Mr. Dr. K. Macken	Regional Manager Eastern Region	phone: 00 353 16674474
	Mr. M. Mcgettigan	Regional Manager Eastern Region	
<b>Italy</b>	Mr. Ezio Morionda	Techniplan	phone: 00 39 685350880
<b>Netherlands</b>	Mr. Bonekamp	DSM (Geleen)	phone: 00 31 4762274
	Mr. Lex de Jonge <i>(member of the BREF Working Group for large volume organic chemicals)</i>	Ministry of the Environment	phone: 00 31 70 3393939 lex.dejonge@dle.dgm.minvrom.nl
	Mr. Foppe de Jong	DCMR (Rotterdam Environmental authority )	phone: 00 31 10 2468291 fdj@dcmr.nl
	Mr. D. Schoen	Exxon Chemical Holland	
	Mr. E.B. de Vries	Shell Nederland Raffinaderij Shell Nederland Chemie	phone: 010-4311791 fax: 010-4311507
<b>Portugal</b>	Mrs. Ana Isabel Garcia	Environmental Engineer Portugal	phone: 00 351 14728989
	Mr. Jose Luis Obesso Gomez		phone: 00 34 915976072
<b>Spain</b>	Mr. S. Garrido (EH&S co-ordinator)	Dow Chemicals - Tarragona	
<b>United Kingdom</b>	Mr. R. Chase	Environment Agency for England and Wales - Bristol (England)	
	Mr. D. Ridley	Environment Agency for England and Wales - Bristol (England)	
	Mr. B. Tilly	Scottish Environmental Protection Agency - Stirling (Scotland)	



## **Annex B: Low emission components and techniques (after [ETBPP-GG71])**

### **Introduction**

This annex offers an overview of the available techniques to reduce VOC emissions. The emphasis is on equipment component in relations to fugitive emissions but also a brief overview of techniques for storage and handling is given. The presented items are:

- valves
- pump shaft seals
- pressure relief valves
- slow rotating equipment
- pipework joints flanges
- filling operations
- quick release couplings
- open-ended filling lines
- Filters
- Pipelines
- storage and handling.

### **Valves**

Popular valves such as 'gate' and 'ball' designs can be a major source of fugitive emissions, with most of the leakage occurring at the valve gland. Typically, a badly leaking valve can emit over 500 kg/year; for solvent costing € 1000/ton, this leakage could cost the company over € 500/year for this valve alone. Major savings can clearly be achieved by addressing leakage from valve glands and ensuring that modern gland sealing systems are installed.

Provided the process parameters and economics are suitable, an alternative is to consider installing diaphragm valves. Such valves, in which the solvent is isolated from the stem by an impervious diaphragm, can be suitable for applications up to 1 600 kN/m<sup>2</sup> (16 bar) and 175°C. The manufacturer's advice should be obtained with respect to the specific application and the choice of material for the diaphragm.

Valve gland seals traditionally consisted of a packing of braided cotton or asbestos yarn, wrapped around the valve stem and compressed into the stuffing box of the valve (see fig B1). Modern packing materials such as PTFE, aramid and graphite have generally replaced the traditional materials. These newer packing materials offer better sealing properties. An increasing range of other alternative sealing systems is available to suit a variety of temperature, pressure and chemical conditions.



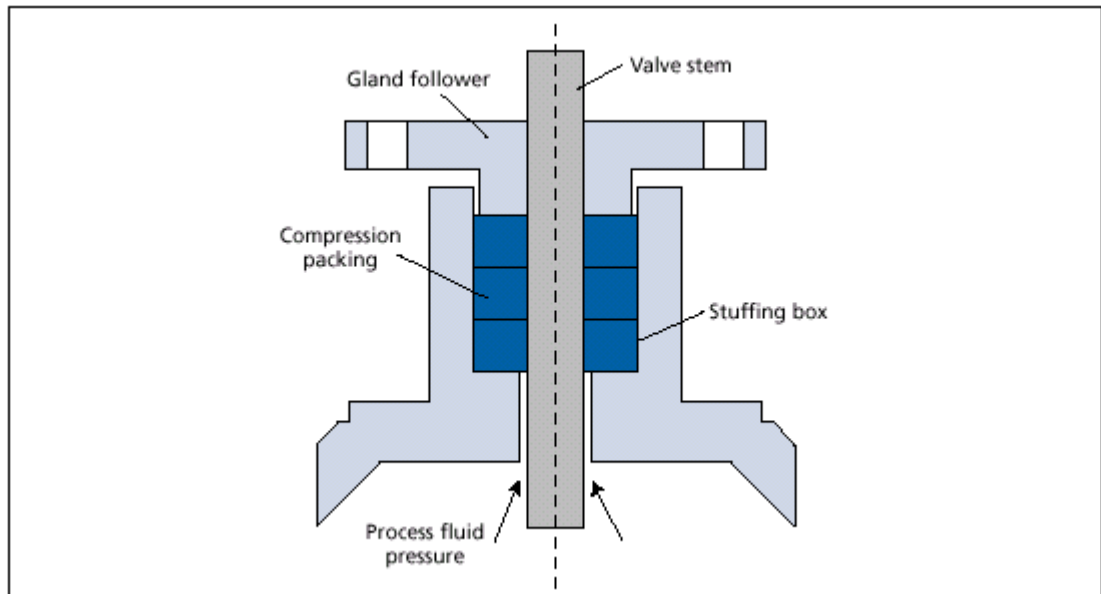

**Figure B1 - Cross-section through a valve gland**

### Conventional stem packing options

Compression packing, which is the most common form of sealing arrangement, is available in two generic types.

- *Braided material:* This is a versatile packing suitable for many applications and therefore used widely. The appropriate length of packing material can be cut from a coil. This eliminates the need to stock large quantities of individually-sized packing material and thus reduces the stores inventory. However, the emission control achievable with this type of packing is generally limited to around 10 000 ppm. This may be unacceptable for certain applications. The materials used for braided packing include acrylic, aramid, PTFE, exfoliated graphite and high temperature polymers.
- *Pre-formed rings:* These are manufactured from braid, extrusions or die-pressed products. Pre-formed rings are generally used where higher standards of emission control are required. These rings are manufactured to tight tolerances and to suit each stem/stuffing box arrangement. However, this may require a large inventory of replacement parts.

### Advanced stem packing

Special valve gland seals are available for specific applications.

- *Combination packing sets:* This type of valve packing assembly consists of die-formed graphite rings, with braided graphite wiper rings located at the top and bottom. Combination packing sets provide a superior level of emission control, typically less than 500 ppm. Profiling the die-pressed rings with 'cup and cone' or 'chevron' designs increases the 'sealability' of the valve. This allows more opportunity for re-tightening the gland normal operation and hence achieving service life. Combination packing sets provide good sealing properties on corroded and pitted stems, thus making them suitable for retrofitting into old, worn valves and prolonging valve life.
- *Bellows seals:* Bellows seals for valve stems consist of heavy-walled bellows made from metal or polymeric materials. The bellows isolate the valve stem from the process fluid and, as a consequence, are regarded as 'zero emission' seals. Bellows seals are generally used for highly toxic applications or in situations where escape of any process fluid is unacceptable.

- However, if the bellows arrangement fails, the potential release of process fluid can be significant. Conventional packing seals are, therefore, often installed as a secondary sealing system.

### Choice of stem sealing option

The technique chosen to seal a valve stem depends on the application. The factors that influence the choice of material include:

- chemical compatibility;
- temperature;
- pressure;
- cost;
- life expectancy of the component;
- frequency of valve use;
- ease and cost of maintenance;
- implications of failure.

Table B1 summarises the applicability and costs associated with the different types of valve sealing arrangement.

**Table B1 - Applications of different valve sealing materials**

Material	Emission control (ppm)	Maximum temperature (°C)	Maximum pressure (bar)	Relative cost*
Braided synthetic fibre packing	<10 000	190	80	1
Moulded or machined thermoplastic packing	<500	285	170	2
Carbon or graphite-based braid packing	<10 000	550**	170	3
Asbestos-based yarn packing	>10 000	480	275	3
Carbon or graphite-based die-formed rings	<500	550**	310	4
Polymeric bellows	0	150	20	5
Metal bellows	0	550**	170	6

\* Cost increases from 1 to 6.

\*\* Under non-oxidising conditions, a higher temperature may be reliably achieved.

### Pump shaft seals

Modern pumps almost exclusively use mechanical seals as shaft seals for solvent pumping applications. Mechanical seals are capable of achieving low fugitive emissions and a long life. The main categories of mechanical seal are discussed in the following Sections. Zero emission operation can be achieved, where necessary, using:

- dual seals (pressurised and unpressurised);
- gas barrier seals;
- sealless pumping systems.

### Single mechanical seals

Single mechanical seals (see figure B2) have traditionally been perceived as a significant source of fugitive emissions from pumps and other rotating machinery. However, modern seal designs can now achieve emission control levels below 500 ppm (US EPA Reference Method 21). Single mechanical seals are used to pump process fluids with a specific gravity greater than 0.4 and where the vapour pressure margin in the seal chamber is greater than  $170 \text{ kN/m}^2$ . As with many mechanical seals, the process fluid has to provide adequate lubrication of the seal faces.

Single mechanical seals have a minimum number of parts and are generally considered both reliable and economical.

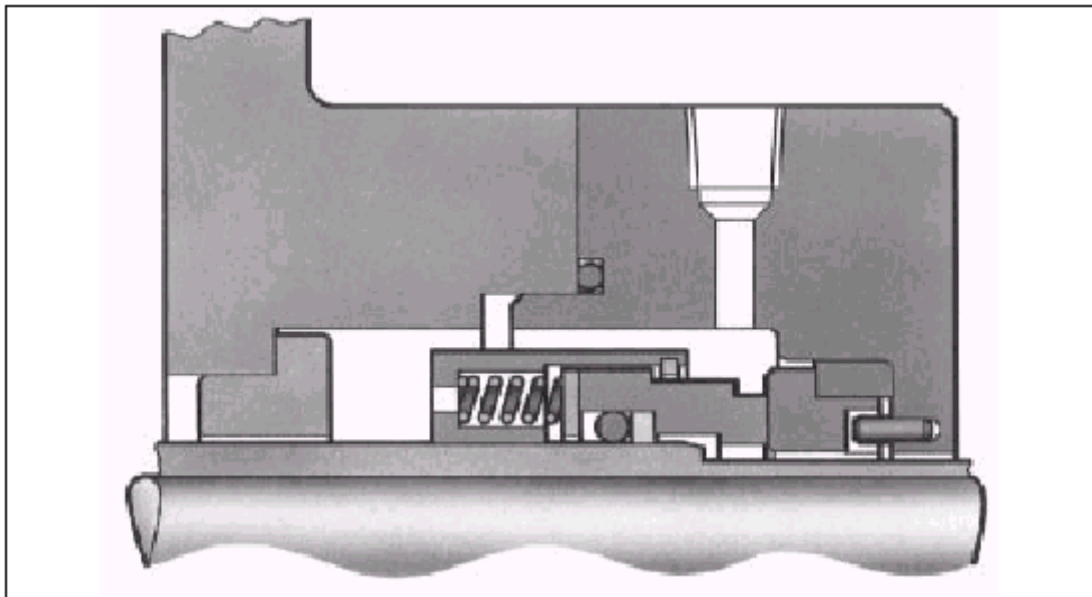

**Figure B2 - Cross-section through a single mechanical seal**

### Secondary containment seals

Secondary containment seals, which are fitted in the seal housing between the single seal and atmosphere, provide an extra level of security without the need to resort to buffer/barrier fluids.

Such seals are available in many forms.

#### **Low technology solutions**

- These include:
- packing rings (usually lubricated by steam);
- dry running lip seal (usually lubricated by steam);
- pressure-activated lip seal;
- fixed-throttle bushing;
- segmented floating spring-loaded throttle bushing (see figure B3).

In normal operation these seals may not provide the best low emissions performance. However, they provide a useful warning of high seal leakage and impending seal failure when used in conjunction with a pressure switch or other sensor. This arrangement enables the pump to be shut down before the leakage becomes excessive.

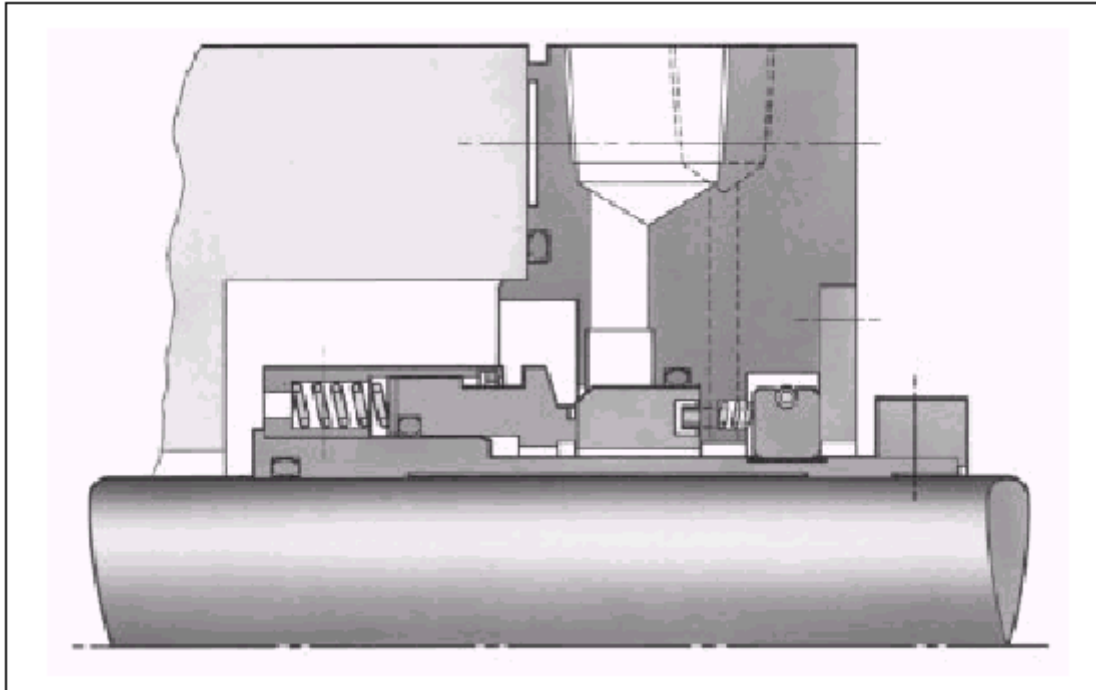

**Figure B3 - Cross-section through a single mechanical seal with segmented floating spring-loaded throttle bushing**

***High technology solutions***

These include:

- dry-running contacting mechanical seal;
- pressure-activated stand-by mechanical seal;
- non-contacting mechanical seal (see figure B4).

Because they can be used with a vent connection to a vapour recovery or flare system, these high technology solutions can achieve lower emissions performance under normal operating conditions. They can also be used with pressure switches or other sensors to flag inboard seal failure.

High technology secondary containment seals are able to take full service pressure in the event of either increased leakage from the primary seal or its complete failure. This allows the pump to be shut down safely and remedial action taken.

These secondary containment seals can be used for several hours at full duty conditions and thousands of hours at lower duties. This is especially beneficial in a batch process, where it may be possible to complete a batch before complete shutdown.

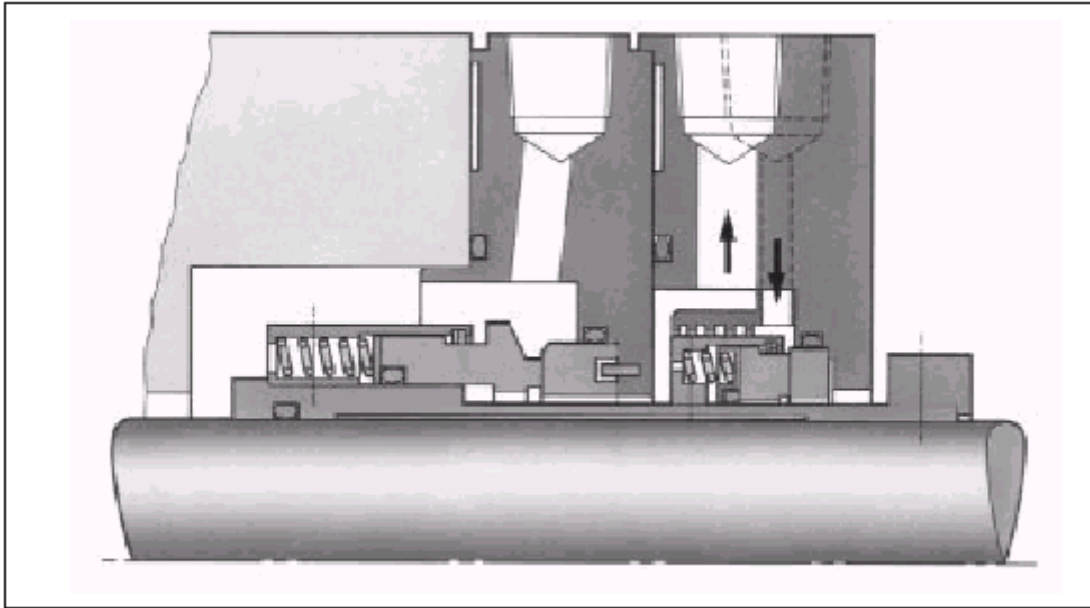
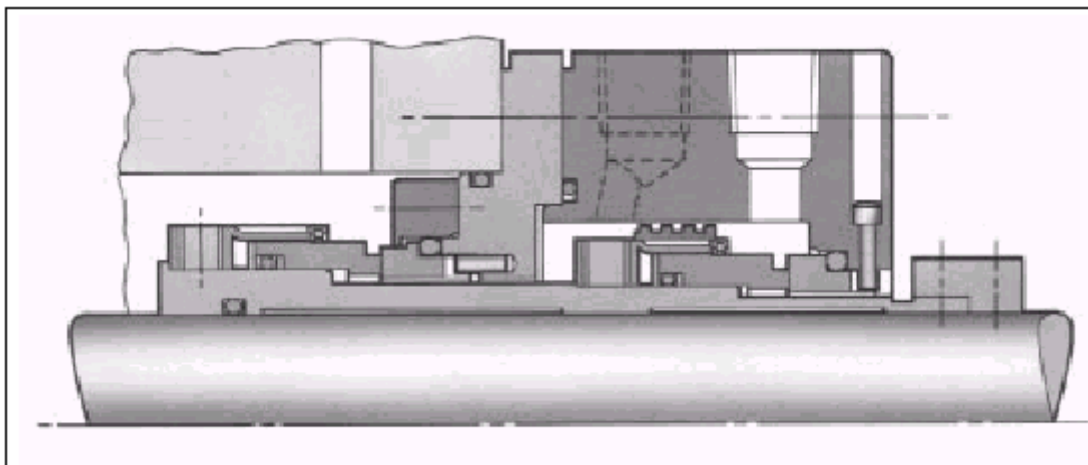

**Figure B4 - Cross-section through a single mechanical seal with a non-contacting secondary containment seal**

***Dual unpressurised seals***

Dual unpressurised or tandem seals (see figure B5) are used when more stringent emission control is required and where contamination of the process fluid by a buffer fluid cannot be tolerated. Emissions of less than 10 ppm (US EPA Reference Method 21) have been reported from pumps at a hydrocarbon plant in the USA using this type of seal.

The seal arrangement consists of an inner and outer seal separated by a buffer fluid maintained at a lower pressure than the process fluid. The buffer fluid is typically water, glycol or alcohol-based. Any failure of the inner seal will cause process fluid to enter the buffer fluid. In practice, some leakage of process fluid into the buffer fluid is inevitable and, if necessary, leakage of light hydrocarbons can be fed to a flare or solvent recovery system.

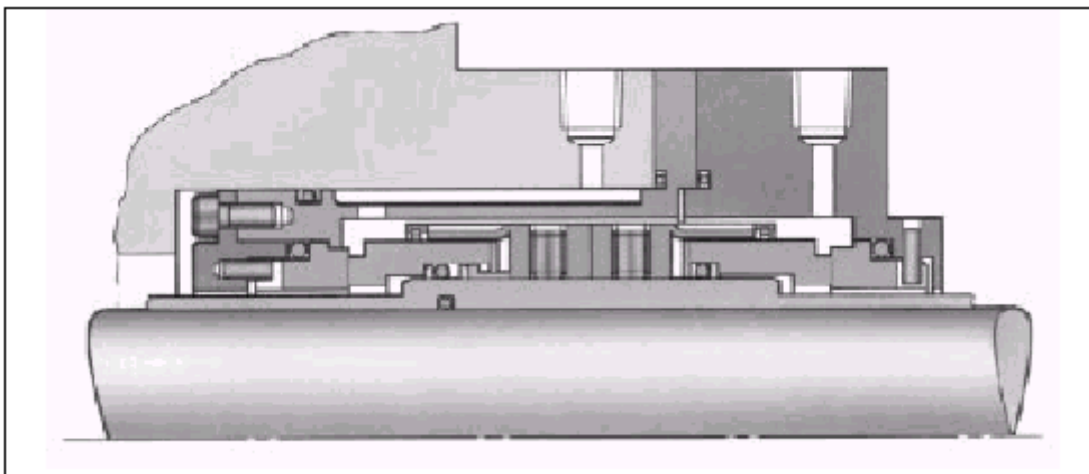

**Figure B5 - Cross-section through a dual unpressurised seal**

**Dual pressurised seals**

Dual pressurised or double seals (see figure B6) are designed to achieve 'zero emission' by maintaining the pressure of the barrier fluid at a higher pressure than the process fluid. The barrier fluid is either liquid or gaseous. Double seals can be used where loss of any process fluid is unacceptable or where the process fluid has poor lubricating properties.

During normal operation, some barrier fluid inevitably enters the process fluid. In the event of the inner seal failing, larger quantities of the barrier fluid are lost to the process stream. To ensure product quality remains unaffected by a seal failure, the barrier fluid must be chemically inert and not react with the process fluid.



**Figure B6 - Cross-section through a dual pressurised seal**

**Gas barrier seals**

Gas barrier seals are a type of dual pressurised seal that use an inert gas such as nitrogen as the barrier fluid. This arrangement can be used with both contacting and non-contacting seal faces.

Some types of non-contacting designs possess grooves in the seal faces to generate lift and separation of the faces during both dynamic and stationary conditions. Such non-contacting systems can improve seal life, while the pressurised gas barrier provides zero emission of the process fluid to atmosphere.

Such seals are usually bought as a pre-assembled cartridge and use nitrogen or compressed air as the gas barrier.

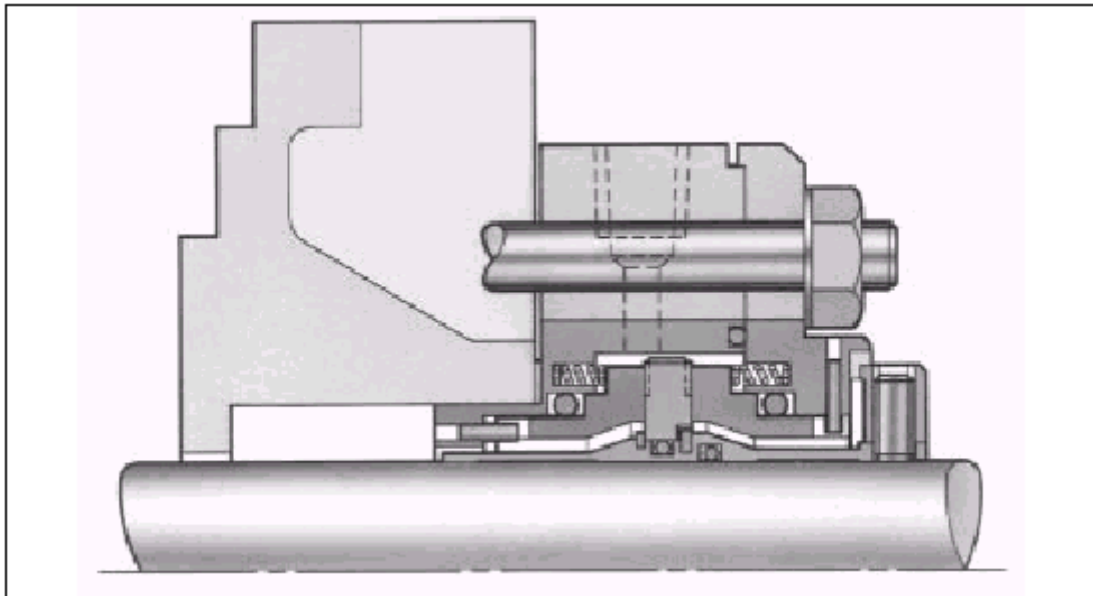

**Figure B7 - Cross-section through a gas barrier seal**

### **Sealless pumps**

Sealless pumps reduce fugitive emissions by eliminating all rotary seals. The technology of this type of pump is improving and sealless pumps are beginning to find new applications.

There are two main types of sealless pump:

- the canned pump, where the motor and pump unit are totally enclosed in a shell;
- the magnetic drive pump, where power is transferred from an external motor to the pump via rotating magnets and a sealed magnetic fluid coupling.

### **Pump seal selection**

Figure B8 and Table B2, which are based on data supplied by the European Sealing Association, indicate the applicability of different mechanical seal arrangements.

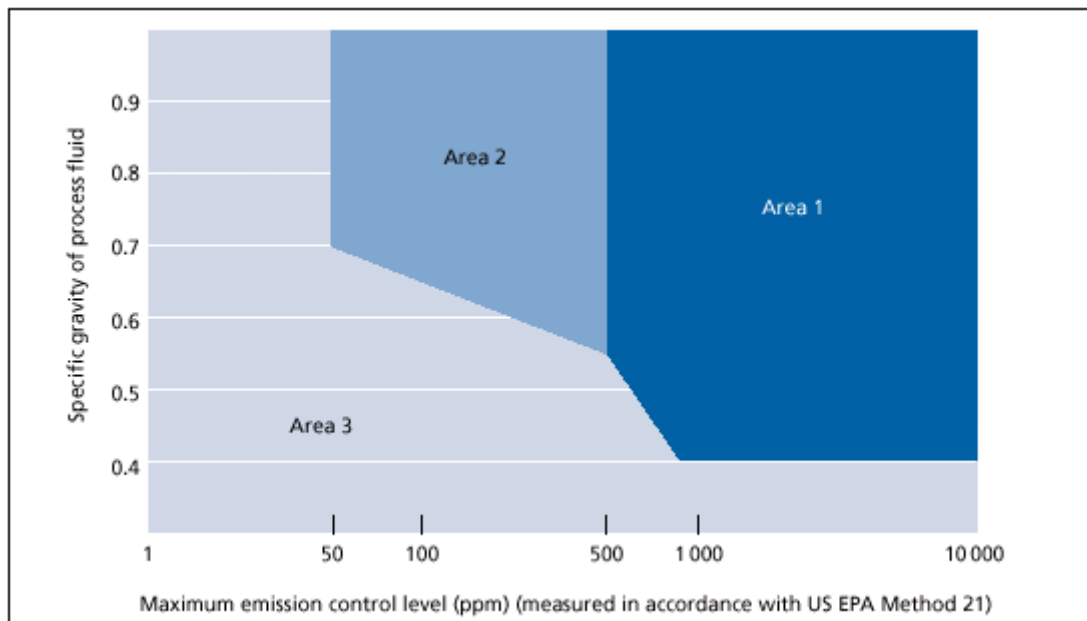

**Figure B8 - Max. emission control level (ppm; measured in accordance with EPA method 21)**

**Table B2 - Acceptable sealing solutions for different levels of emission control (Based on data supplied by the European Sealing Association).**

Area	Maximum leakage rate (g/hour)	Specific gravity of process fluid	Acceptable sealing solution
1	2.5 - 24	> 0.4	- General purpose single seals - Advanced technology single seals - Dual unpressurised and pressurised seals
2	0.5 - 2.5	> 0.4 to 0.7	- Advanced technology single seals
3	< 0.5	> 0.4	- Advanced technology single seals vented to a closed system - Dual unpressurised and pressurised seals vented to a closed system
		< 0.4	- Dual pressurised seals

**Pressure relief valves**

Pressure relief valves can be categorised into two common types:

- pilot-operated relief valves;
- spring-loaded relief valves.

The valve seats of pressure relief valves traditionally involve metal to metal contact; this requires lapping to ensure a tight seal. More pliant materials such as PTFE are now becoming more widespread as the seat material in relief valves. Depending on the application, these flexible seals may need to be replaced every two to five years.



Fugitive losses from pressure relief valves are usually due to:

- incorrect re-seating of the valve after operation;
- frequent operation of the valve due to the system pressure being too close to the set actuation pressure;
- valve operation in response to a genuine over-pressure situation.

Pilot-operated relief valves are designed so that the seal is maintained by the system pressure acting above and below the main seal. When the system pressure increases to the set point pressure, a pilot line vents to atmosphere. This decreases the pressure above the main seal and enables the valve to vent fully. Pilot-operated relief valves typically commence operation at around 95% of the set point pressure. With spring-loaded relief valves, however, the system pressure acts against a spring and the valve commences opening at approximately 90% of the set point pressure.

A less common design is the buckling pin relief valve. This device relies on a retaining pin yielding under load to give full bore venting. Such pins must be replaced after operation.

Fitting a rupture disc upstream of relief valves can help to reduce fugitive emissions. Such discs must be replaced after failure.

An alternative approach - which may be suitable for some applications - is to pipe the exhaust port of the relief valve to a secondary system and thus allow the solvent to be recovered or piped to a flare stack. The risk of over-pressure due to system back pressure necessitates careful design of such systems.

### **Slow rotating equipment**

Leakage from slow rotating equipment using gland packing seals, such as mixers and filters, can be controlled in certain applications by fitting disc springs to the gland nuts. This technique, known as 'live loading', involves applying a constant force to the gland follower. It can be used to compensate for thermal and pressure cycling effects.

Further leakage may occur through the packing as a result of the vessel oscillating on the shaft as it rotates. This leakage can be reduced by incorporating floating gland seal arrangements – which move with the shaft - in the design.

### **Pipework joints and flanges**

Where possible, pipework joints should be avoided. Welded joints should be used where screwed or flanged joints are not required for maintenance purposes. Where mechanical joints such as flanges are required, the joint should be designed to suit the temperature and pressure requirements.

Flanges are commonly used for connecting pipework to components such as valves, pumps and vessels. A gasket is fitted between the faces of the mating flanges to accommodate imperfections in the face material and slight misalignment.

Typical defects encountered on flanged joints include:

- non-parallel flange faces;
- face damage;
- poor surface condition;
- face distortion;

- incorrect bolt specification or tightening procedure;
- incorrect bolt stress;
- incorrectly rated flanges;
- unsuitable face design;
- unsuitable gasket material or thickness.

All these problems can be avoided by careful attention to detail.

A range of gasket materials is available for flanged joints:

#### **Compressed fibre materials**

These materials have been used for many years as the basis of the gasket seal. The fibres, which may be either organic or inorganic, are bound with elastomers under high load to provide sheet materials compatible with a wide range of fluids. By selecting various fibres and bonding them with different elastomers, the performance of the sheet materials can be tailored to meet specific applications.

#### **Compressed asbestos fibre**

Historically, compressed asbestos fibre has been the most widely used material for flange gasket applications. For many applications it is being superseded by alternative fibres.

Correct storage is important for all compressed fibre materials. The elastomeric structure undergoes ageing, with subsequent loss of performance with time.

#### **Carbon fibre**

Carbon-based gaskets have excellent thermal stability, load retention characteristics and chemical compatibility. The capability to operate at high temperatures ensures that carbon fibre gaskets are suitable for most applications, except where oxidation may occur.

#### **PTFE**

PTFE gaskets are traditionally used in chemical applications where inert sealing materials are required. PTFE is a soft material, which is unaffected by many chemicals, including strong acids. However, the material can suffer from poor recovery after deformation. PTFE gaskets are, therefore, vulnerable to creep; this is more significant at higher temperatures.

#### **Filling operations**

Significant fugitive emissions may arise when filling storage vessels, mixing vessels or other containers due to the displacement of solvent-rich air.

When filling vessels from storage tanks, intermediate bulk containers (IBCs) or larger vessels, a principle known as back venting (see figure B9) or balanced pumping can be used. With this arrangement, the displaced air is vented back to the original vessel, thus preventing its escape to atmosphere.

An alternative approach is to pass the displaced air through a solvent recovery vessel or an adsorption canister prior to its release to atmosphere (see figure B10).

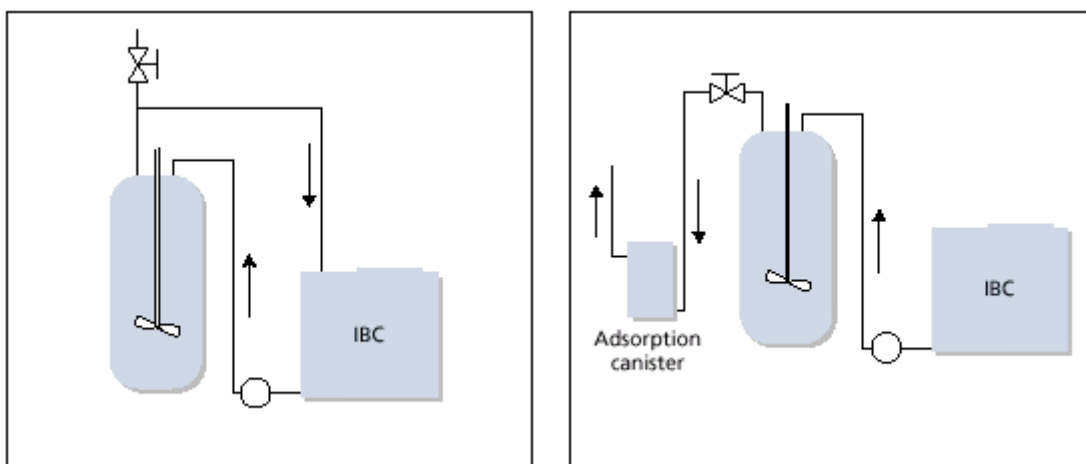

**Figure B9 - Back venting during filling of an IBC & Solvent recovery during filling of an IBC**

### Quick release couplings

These components should be kept clean and the seals maintained in a good state of repair. Filling and discharge connections to road tankers can be self-sealing, dry break couplings. If the tanker drives off while it is still connected, the coupling separates and seals, thus preventing spillage. This can be particularly important for applications using flammable solvents where safety issues are paramount.

### Open-ended filling lines

These are often found at the connections between storage or mixing tanks and product containers. Such lines can allow significant quantities of solvent to escape as fugitive emissions. The different measures that can be taken to isolate different types of open-ended filling lines are:

- The line is no longer used: Insert a blank
- The line is used occasionally: Insert a plug
- The line is used frequently: Fit a second valve or quick release blank

Investigations should be carried out to determine whether these measures are both feasible and safe. Employees should be made aware of the need to seal open lines. Regular checks should be performed to ensure that this is occurring.

### Filters

In certain specialist sectors, such as adhesives manufacture, products containing solvent may need to be filtered prior to filling containers. Muslin bags, which are cheap and easy to replace, are often used for this purpose. However, this method of filtration gives rise to fugitive emissions, which usually require local exhaust ventilation.

The use of enclosed filtration systems should be considered.

### Leaking pipelines

Mechanical damage or corrosion can give rise to leaks of solvent from pipework. Such leaks can create a significant hazard.

Most defects of this kind can be rectified as soon as they are detected. However, if it is not possible to take the pipework out of service immediately due to other, overwhelming safety considerations, the use of specialist companies with expertise in repairing leaks in pressurised pipelines should be considered.

### Storage and handling

A brief overview of the measure to prevent and reduce diffuse VOC emissions is presented in table B3. The available vapour recovery techniques are presented in annex H.

**Table B3 - Brief overview (Selection out of [Ref. LRTAP-VOC])**

Source of emission	Emission control measures	Reduction efficiency	Abatement costs and savings
<b>Process units</b>			
1 Process-unit turnarounds	Flares/process furnace vapour recovery	I	Not available
2 Wastewater separator	Floating cover	II	Medium costs/savings
<b>Storage of crude oil and products</b>			
3 Petrol	Internal floating roofs with secondary seals	I - II	Savings
	Floating roof tanks with secondary seals	II	Savings
4 Crude oil	Floating roof tanks with secondary seals	II	Savings
5 Petrol marketing terminals (loading and unloading of trucks, barges and trains)	Vapour recovery unit	I - II	Savings
6 Petrol service stations (Stage I)	Vapour balance on tank trucks	I - II	Low costs/savings
(Stage II)	Vapour balance during refuelling (refuelling nozzles)	I (- II**)	Medium costs*

Stage I: Emissions originated at the loading of petrol at the refinery (via intermediate terminals) up to its discharge at petrol service stations

Stage II: emissions from the refuelling of cars at service stations

\* depending on capacity (station size), retrofitting or new service stations.

\*\* will increase with increasing penetration of standardisation of vehicle filling pipes

Reduction efficiency: I = > 95 per cent; II = 80-95 per cent; III = < 80 per cent.

Total cost: High >500 €/t VOC abated  
Medium 150-500 €/t VOC abated  
Low <150 €/t VOC abated

Ad1. Process-unit turnaround emissions may be controlled by venting vessel vapours to vapour recovery systems or controlled flaring.

Ad 2. VOC emissions in connection with wastewater handling and treatment can be reduced by several means. Water-seal controls can be installed, as can junction boxes, equipped with tight-fitting covers, in drain systems. Sewer lines can be covered. Alternatively, the drain system can be completely closed to the atmosphere.

Oil-water separators, including separation tanks, skimmers, weirs, grit chambers, sludge hoppers and slop-oil facilities, can be equipped with fixed roofs and closed vent systems that direct vapours to a control device, designed either for the recovery or destruction of the VOC vapours. Alternatively, oil-water separators can be equipped with floating roofs with primary and secondary seals. The effective reduction of VOC emissions from waste-water treatment plants can be achieved by draining oil from process equipment to the slop-oil system, thus minimising the oil-flow into the wastewater treatment plant. The temperature of incoming water can also be controlled in order to lower emissions to the atmosphere.

Ad 3/4. VOC emissions from the storage of crude oil and products can be reduced by equipping fixed-roof tanks with internal floating roofs or by equipping floating-roof tanks with secondary seals.

Ad 5. VOC emissions from the storage of petrol and other light liquid components can be reduced by several means. Fixed-roof tanks can be equipped with internal floating roofs with primary and secondary seals or connected to a closed vent system and an effective control device, e.g. vapour recovery, flaring or combustion in process heaters. External floating-roof tanks with primary seals can be equipped with secondary seals, and/or supplemented with tight, fixed roofs, with pressure relief valves which can be connected to the flare.

Ad 6. Stage I control consists of vapour balancing and vapour collection at the loading of petrol, and recovering the vapour in recovery units. Furthermore, vapour collected at service stations from the discharge of petrol from trucks can be returned and recovered in vapour recovery units. Stage II control consists of vapour balancing between the vehicle fuel tank and the service station's underground storage tank. Stage II together with Stage I is the best available technology for reducing evaporative emissions during petrol distribution.

## Annex C: Example of diffuse emissions regulations

Two examples of the licensing in the USA are presented here:

- Fugitive emissions
- Loading activities.

### **RULE 1173. FUGITIVE EMISSIONS OF VOLATILE ORGANIC COMPOUNDS**

(Adopted July 7, 1989)(Amended December 7, 1990)(Amended May 13, 1994)

#### **(a) Purpose**

This rule is intended to control volatile organic compounds leaks from valves, fittings, pumps, compressors, pressure relief devices, diaphragms, hatches, sight-glasses, and meters at refineries, chemical plants, oil and gas production fields, natural gas processing plants, and pipeline transfer stations.

#### **(b) Definitions:**

For the purpose of this rule the following definitions shall apply:

1. BACKGROUND is the ambient concentration of volatile organic compounds in the air determined at least one (1) meter upwind of the component to be inspected.
2. CHEMICAL PLANT is any facility engaged in producing organic or inorganic chemicals, and/or manufacturing products by chemical processes. Any facility or operation that has 282 as the first three digits in its Standard Industrial Classification Code as defined in the Standard Industrial Classification Manual is included.
3. COMMERCIAL NATURAL GAS is a mixture of gaseous hydrocarbons, with at least 80 percent methane, and less than 10 percent by weight volatile organic compounds, determined according to test methods specified in subparagraph (g)(2).
4. COMPONENT is any valve, fitting, pump, compressor, pressure relief device, diaphragm, hatch, sight-glass, and meter. They are further classified as:
  - (A) MAJOR COMPONENT is any 4-inch or larger valve, any 5-hp or larger pump, any compressor, and any 4-inch or larger pressure relief device.
  - (B) MINOR COMPONENT is any component which is not a major component.
5. COMPRESSOR is a device used to compress gases and/or vapours by the addition of energy, and includes all associated components used for connecting and sealing purposes.
6. EXEMPT COMPOUNDS are any of the following compounds:
  - (A) Group I (General)
    - trifluoromethane (HFC-23)
    - pentafluoroethane (HFC-125)
    - 1,1,2,2-tetrafluoroethane (HFC-134)
    - tetrafluoroethane (HFC-134a)
    - 1,1,1-trifluoroethane (HFC-143a)
    - 1,1-difluoroethane (HFC-152a)
    - chlorodifluoromethane (HCFC-22)
    - dichlorotrifluoroethane (HCFC-123)
    - 2-chloro-1,1,1,2-tetrafluoroethane (HCFC-124)
    - dichlorofluoroethane (HCFC-141b)
    - chlorodifluoroethane (HCFC-142b)
    - cyclic, branched, or linear, completely fluorinated alkanes
    - cyclic, branched, or linear, completely fluorinated ethers with no unsaturations

cyclic, branched, or linear, completely fluorinated tertiary amines with no unsaturations  
sulfur-containing perfluorocarbons with no unsaturations and with sulfur bonds only to carbon  
and fluorine

(B) Group II

methylene chloride

1,1,1-trichloroethane (methyl chloroform)

trifluoromethane (FC-23)

trichlorotrifluoroethane (CFC-113)

dichlorodifluoromethane (CFC-12)

trichlorofluoromethane (CFC-11)

dichlorotetrafluoroethane (CFC-114)

chloropentafluoroethane (CFC-115)

The use of Group II compounds and/or carbon tetrachloride may be restricted in the future because they are toxic, potentially toxic, upper-atmosphere ozone depleters, or cause other environmental impacts. By January 1, 1996, chlorofluorocarbons (CFC), 1,1,1-trichloroethane (methyl chloroform), and carbon tetrachloride will be phased out in accordance with the Code of Federal Regulations Title 40, Part 82 (December 10, 1993).

7. FACILITY is a refinery, chemical plant, oil and gas production field, natural gas processing plant, or pipeline transfer station.
8. FIELD GAS means feed stock gas entering the natural gas processing plant.
9. FITTING is a component used to attach or connect pipes or piping details, including but not limited to flanges and threaded connections.
10. GAS LEAK is one of the following:
  - (A) MAJOR GAS LEAK FOR ANY COMPONENT EXCEPT FOR A PRESSURE RELIEF DEVICE is the detection of gaseous volatile organic compounds in excess of 10,000 ppm as methane above background measured according to test procedures in subparagraph (h)(1).
  - (B) MINOR GAS LEAK FOR ANY COMPONENT EXCEPT FOR A PRESSURE RELIEF DEVICE is the detection of gaseous volatile organic compounds in excess of 1,000 ppm but not more than 10,000 ppm as methane above background measured according to test procedures in subparagraph (h)(1).
  - (C) MAJOR GAS LEAK FOR A PRESSURE RELIEF DEVICE is the detection of gaseous volatile organic compounds in excess of 200 ppm as methane above background measured according to test procedures in subparagraph (h)(1).
11. HATCH is any covered opening system that provides access to a tank or container, usually through the top deck.
12. INACCESSIBLE COMPONENT is any component located over five meters above ground when access is required from the ground; or any component located over two meters away from a platform when access is required from the platform; or any component which would require the elevation of a monitoring personnel higher than two meters above permanent support surfaces.
13. INSPECTION is either of the following:
  - (A) OPERATOR INSPECTION is a survey of components by the operator for the purpose of determining compliance with this rule.
  - (B) DISTRICT INSPECTION is a survey of components by District personnel or their representatives.
14. LIQUID LEAK is the dripping of liquid volatile organic compounds at the rate of more than three drops per minute.

15. LUBRICATING FLUID is a fluid that provides lubrication of moving parts in a pump, including barrier fluids.
16. NATURAL GAS PROCESSING PLANT is a facility engaged in the separation of natural gas liquids from field gas and/or fractionation of the liquids into natural gas products, such as ethane, propane, butane, and natural gasoline. Excluded from the definition are compressor stations, dehydration units, sweetening units, field treatment, underground storage facilities, liquefied natural gas units, and field gas gathering systems unless these facilities are located at a natural gas processing plant.
17. OIL AND GAS PRODUCTION FIELD is a facility on which crude petroleum and natural gas production and handling are conducted, as defined in the Standard Industrial Classification Manual as Industry No. 1311, Crude Petroleum and Natural Gas.
18. PIPELINE TRANSFER STATION is a facility which handles the transfer and storage of petroleum products or crude petroleum in pipelines.
19. PLATFORM is any raised, permanent, horizontal surface for the purpose of gaining access to components.
20. PRESSURE RELIEF DEVICE (PRD) is a pressure relief valve or a rupture disc.
21. PRESSURE RELIEF VALVE (PRV) is a valve which is automatically actuated by upstream static pressure, and used for safety or emergency purposes.
22. PUMP is a device used to transport fluids by the addition of energy, and includes all associated components used for connecting or sealing purposes.
23. REFINERY is a facility that processes petroleum, as defined in the Standard Industrial Classification Manual as Industry No. 2911, Petroleum Refining.
24. REPAIR is any of the following:
  - (A) ON-SITE REPAIR is corrective action for the purpose of eliminating leaks and which is not a significant repair.
  - (B) SIGNIFICANT REPAIR is corrective action for the purpose of eliminating leaks involving the temporary removal or taking out of service of a component.
25. RUPTURE DISC is a diaphragm held between flanges for the purpose of isolating a volatile organic compound from the atmosphere or from a downstream pressure relief valve.
26. VALVE is a device that regulates or isolates the fluid flow in a pipe, tube, or conduit by means of an external actuator; including flanges, flange seals, and other components used for attachment or sealing.
27. VOLATILE ORGANIC COMPOUND (VOC) is any volatile compound containing the element carbon, excluding methane, carbon monoxide, carbon dioxide, carbonic acid, metallic carbides or carbonates, ammonium carbonate, and exempt compounds.

**(c) Leak Control Requirements**

1. Any liquid leak or gas leak of over 50,000 ppm detected by District inspection shall constitute a violation of this rule.
2. Any major gas leak detected by District inspection, within any continuous 24-hour period, and numbering in excess of the Leak Thresholds for that component listed below in Table 1, shall constitute a violation of this rule.



**Table C1 - Leak thresholds**

<b>Component</b>	<b>Max. No. of Leaks (200 or less components inspected)</b>	<b>Max. No. of Leaks (over 200 components inspected)</b>
Valves	1	0.5% of number inspected
Pumps	2	1% of number inspected
Compressors	1	1
PRDs	1	1
Other Components	1	1

The maximum number of leaks in Table C1 shall be rounded upwards to the nearest integer, where required.

- Open-ended lines and valves located at the end of lines shall be sealed with a blind flange, plug, cap, or a second closed valve, at all times except during operations requiring process fluid flow through the open-ended line.

**(d) Identification Requirements**

- All major components shall be physically identified clearly and visibly for inspection, repair, replacement, and recordkeeping purposes.
- All minor components shall be clearly identified in Piping and Instrumentation (P&I) flow diagrams, and/or grouped together functionally for inspection, repair, replacement, and recordkeeping purposes.
- Any change(s) in major component identification shall require prior written approval from the Executive Officer's designee.

**(e) Operator Inspection Requirements**

- All accessible pumps, compressors, and pressure relief devices shall be audio-visually inspected once during every eight-hour operating period, except for unmanned oil and gas production fields, and unmanned pipeline transfer stations.
- All accessible components shall be inspected quarterly.
- All inaccessible components shall be inspected annually.
- A pressure relief device shall be inspected within 14 calendar days after every functional pressure relief.
- The inspection frequency for accessible components, except pumps and compressors, at a facility, as required in subparagraph (e)(2), may change from quarterly to annually, provided all of the following conditions are met.
  - All accessible components, except pumps and compressors, at that facility have been successfully operated and maintained with no liquid leaks and with major gas leaks within the Leak Thresholds for such components listed in Table 1, for five consecutive quarters; and
  - The above is substantiated by documentation and submitted for written approval from the Executive Officer's designee.
- The annual inspection frequency for all accessible, components, except pumps and compressors, if approved in subparagraph (e)(5), shall revert to quarterly, should the annual inspection or District inspection show any liquid leak or major gas leaks in excess of the Leak Thresholds for such components listed in Table 1.

**(f) Maintenance Requirements**

- A component shall be repaired or replaced within the following time period after detection of the leak by operator inspection or District inspection, according to Table 2, Repair Periods.

**TableC2 - Repair periods**

<b>Type of Leak</b>	<b>Time Period</b>
Minor Gas Leak	14 Calendar Days
Major Gas Leak	5 Calendar Days
Gas Leak over 50,000 ppm	1 Calendar Day
Liquid Leak	1 Calendar Day

2. The repaired or replaced component shall be subjected to operator inspection within 30 days of the repair or replacement.
3. A component or parts thereof shall be replaced with Best Available Control or Retrofit Technology (BACT or BARCT), or vented to an air pollution control device approved by the Executive Officer's designee, after it has been subjected to five significant repair actions for a liquid leak or a major gas leak within a continuous twelve-month period.
4. The reporting provisions of Rule 430 shall not be applicable to components being repaired or replaced under the provisions of this rule, except compressors.

**(g) Recordkeeping Requirements**

1. Records of leaks detected by quarterly or annual operator inspection, and subsequent repair and reinspection, shall be submitted to the Executive Officer's designee, within 30 or 60 days, respectively. Such records shall be submitted on standard forms specified by the District and shall contain all information required on the form.

**(h) Test Methods**

1. Measurements of gaseous volatile organic compound leak concentrations shall be conducted according to EPA Reference Method 21 using an appropriate analyser calibrated with methane at a distance of 1 cm or less from the source.
2. The volatile organic compound content of fluids shall be determined using ASTM methods E-168, E-169, or E-260, or any other alternative test method approved in advance as a source-specific State Implementation Plan revision by the United States Environmental Protection Agency and the California Air Resources Board, and authorised by the Executive Officer's designee.
3. All records of operator inspection and repair shall also be maintained at the facility for a period of two (2) years and made available to the District staff on request.

**(i) Compliance Schedule**

All facilities shall be in compliance with this rule by February 1, 1991.

**(j) Other Rules and Regulation Applicability**

1. Affected facilities shall comply with the provisions of Rules 466, 466.1, and 467 until February 1, 1991, or until compliance with this rule is achieved, whichever is earlier.
2. In case of conflict between the provisions of this rule and any other rule, the provisions of the rule which more specifically applies to the subject shall prevail.

**(k) Exemptions**

The provisions of this rule shall not apply to the following cases, where the person seeking the exemption shall supply the proof of the applicable criteria to the satisfaction of the Executive Officer's designee:

1. Components which present a safety hazard for inspection as documented and established in a safety manual or policy, previously, or with the prior written approval of the Executive Officer's designee except that these components shall be monitored for leaks when it is safe to do so. Upon detection of a leak, component(s) shall be repaired or replaced as soon as the repairs or replacement can be carried out safely.
2. Components being repaired or replaced within the specified repair or replacement period, as given in Table 2.
3. Components exclusively handling commercial natural gas.
4. Components exclusively handling fluids with a VOC concentration of ten percent by weight or less, determined according to test methods specified in subparagraph (h)(2).
5. Components incorporated in lines, while operating under negative pressures.
6. Components totally contained or enclosed such that there are no VOC emissions into the atmosphere.
7. Lubricating fluids.
8. Components buried below ground.
9. Components handling liquids exclusively, if the weight percent evaporated is ten percent or less at 150°C, as determined by ASTM Method D-86.
10. Pressure vacuum valves on storage tanks.

**RULE 462. ORGANIC LIQUID LOADING**

*(Adopted Jan. 9, 1976) (Amended May 5, 1978) (Amended Oct. 14, 1979)  
(Amended April 4, 1986) (Amended December 7, 1990) (Amended June 9, 1995)  
(Amended May 14, 1999)*

**(a) Purpose**

This rule is intended to control emissions of volatile organic compounds (VOC) from facilities that load organic liquids with a vapour pressure of 1.5 psia (77.5 mm Hg) or greater under actual loading conditions into any tank truck, trailer, or railroad tank car.

**(b) Definitions**

For the purpose of this rule, the following definitions shall apply:

1. BACKGROUND is the ambient concentration of organic vapours in the air measured according to the EPA Method 21 subsection 4.3.2.
2. CLASS "A" FACILITY is any facility which loads 20,000 gallons (75,700 liters) or more on any one day of organic liquids into any tank truck, trailer, or railroad tank car.
3. CLASS "B" FACILITY is any facility:
  - (A) which was constructed before January 9, 1976 and loads more than 4,000 gallons (15,140 liters) but not more than 20,000 gallons (75,700 liters) of gasoline on any one day into any tank truck, trailer, or railroad tank car.
  - (B) which was constructed before January 9, 1976 and loads not more than 4,000 gallons (15,140 liters) of gasoline on any one day, but more than 500,000 gallons (1,892,500 liters) of gasoline in any one calendar year, into any tank truck, trailer, or railroad tank car.
  - (C) which was constructed after January 9, 1976 and loads not more than 20,000 gallons (75,700 liters) of gasoline on any one day into a tank truck, trailer or railroad tank car.
4. CLASS "C" FACILITY is any facility existing before January 9, 1976 which loads not more than 4,000 gallons (15,140 liters) of gasoline on any one day and not more than 500,000 gallons in any one calendar year, into any tank truck, trailer, or railroad tank car.
5. EXEMPT COMPOUNDS are as defined in Rule 102.
6. FACILITY is an organic liquid or gasoline loading rack or set of such racks that load organic liquid or gasoline into tanks, trailers or railroad cars, which are located on one or more contiguous properties within the District, in actual physical contact or separated solely by a public roadway or other public right-of-way, and are owned or operated by the same person or persons under common control.
7. FACILITY VAPOUR LEAK is an escape of organic vapours from a source other than a tank truck, trailer or railroad tank car in excess of 3,000 ppm as methane above background when measured according to EPA Method 21. A facility vapour leak source does not include liquid spillage or condensate resulting from "liquid leaks".
8. GASOLINE is any petroleum distillate or petroleum distillate/alcohol blend or alcohol, except any liquefied petroleum gas (LPG), which has a vapour pressure of 1.5 psia (77.5 mm Hg) or greater under actual loading conditions and is used as a fuel for internal combustion engines.
9. LIQUID LEAK is a dripping of liquid organic compounds at a rate in excess of three drops per minute from any single leak source other than the liquid fill line and vapour line of disconnect operations.
10. LIQUID LEAK FROM DISCONNECT OPERATIONS is defined as: (a) more than two milliliters of liquid drainage per disconnect from a top loading operation; or (b) more than ten milliliters of liquid drainage per disconnect from a bottom loading operation. Such liquid drainage shall be determined by computing the average drainage from three consecutive disconnects at any one loading arm.

11. ORGANIC LIQUID is any liquid compound containing the element carbon that has a vapour pressure of 1.5 psia (77.5 mm Hg) or greater under actual loading conditions excluding liquefied petroleum gases (LPG), methane, carbon monoxide, carbon dioxide, carbonic acid, metallic carbides or carbonates, ammonium carbonate, and exempt compounds.
12. SUBMERGED FILL LOADING is a type of organic liquid loading operations where the discharge opening is completely submerged when the liquid level above the bottom of the vessel is eight centimeters (3.2 inches) or higher.
13. SWITCH LOADING is a transfer of organic liquids with a vapour pressure of less than 1.5 psia (77.5 mm Hg) under actual loading condition into any tank truck, trailer or railroad tank car that was loaded with an organic liquid with a vapour pressure of 1.5 psia (77.5 mm Hg) or greater immediately preceding the transfer.
14. TRANSFER EQUIPMENT shall consist of all the components of the liquid loading line between the liquid pump and the transporting vessel, and the vapour return line from the transporting vessel to the storage tank, or to and including the vapour recovery system.
15. TRANSPORT VESSEL is a tank truck, trailer or railroad tank car that is equipped to receive and transport organic liquid.
16. TRANSPORT VESSEL VAPOUR LEAK is an escape of organic vapours from a transport vessel in excess of 100 percent of the LEL when monitored according to the CARB Vapour Recovery Test Procedure TP-204.3 – Determination of Leak(s).
17. VAPOUR DISPOSAL SYSTEM is a control equipment designed and operated to reduce VOC emissions into the atmosphere.
18. VAPOUR RECOVERY SYSTEM is a vapour gathering system which is capable of collecting and returning discharged hydrocarbon vapours and gases during loading of organic liquids into transport vessels, back to a stationary storage container, or into an enclosed process system.
19. VOLATILE ORGANIC COMPOUND (VOC) is any volatile compound containing the element carbon, excluding methane, carbon monoxide, carbon dioxide, carbonic acid, metallic carbides or carbonates, ammonium carbonate, and exempt compounds.

**(c) Applicability**

The provisions of this rule shall apply to all the organic liquid loading facilities that are defined as Class A, B or C facilities pursuant to paragraphs (b)(2), (b)(3) and (b)(4) of this rule.

**(d) Requirements**

1. Loading Requirements at Class A Facilities
  - (A) Each Class A facility shall be equipped with
    - (i) a CARB certified vapour recovery and/or disposal system, or;
    - (ii) a District-approved vapour recovery and/or disposal system only when such system does not require CARB certification pursuant to Health and Safety Code 41954.
  - (B) Each vapour recovery and/or disposal system at a Class A facility shall be equipped with a continuous monitoring system (CMS) that is installed, operated, and maintained according to the manufacturer's specifications and is approved by the Executive Officer or designee.
  - (C) The transfer of organic liquids shall be accomplished in such a manner that the displaced organic vapours and air are vented under design conditions to the vapour recovery and/or disposal system.
  - (D) Each vapour recovery and/or disposal system shall reduce the emissions of VOCs to 0.08 pound or less per thousand gallons (10 grams per 1,000 liters) of organic liquid transferred.
  - (E) Any Class A facility transferring gasoline into any truck, trailer, or railroad tank car shall be designed and operated for bottom loading only.

- (F) The transfer equipment shall be operated and maintained so that there are no overfills, facility vapour leaks, liquid leaks, or liquid leaks from disconnect operations.
  - (G) The backpressure in the vapour recovery and/or disposal system shall not exceed 18 inches of water column pressure.
2. Loading Requirements at Class B Facilities
- (A) Each Class B facility shall be equipped with
    - (i) a CARB certified vapour recovery and/or disposal system, or;
    - (ii) a District-approved vapour recovery and/or disposal system only when such system does not require CARB certification pursuant to Health and Safety Code 41954.
  - (B) Such system shall be designed and operated to recover at least 90 percent of the displaced vapours.
  - (C) The backpressure in the vapour recovery system shall not exceed 18 inches of water column pressure.
  - (D) Any Class B facility transferring gasoline into any truck, trailer, or railroad tank car, shall be designed for bottom loading only.
  - (E) The transfer equipment shall be operated and maintained so that there are no overfills, facility vapour leaks, liquid leaks, or liquid leaks from disconnect operations.
3. Loading Requirements at Class C Facilities
- (A) Each Class C facility shall be equipped and operated for submerged fill loading or bottom fill loading. All gasoline or equivalent vapour pressure organic liquids shall be transferred in this manner.
  - (B) The transfer equipment shall be operated and maintained so that there are no overfills, liquid leaks, or liquid leak from disconnect operations.
4. Loading Requirements for Transport Vessels
- (A) No person shall allow loading or unloading of organic liquid or other use or operation of any transport vessel unless the vessel has a valid certification of vapour integrity as defined by the applicable Air Resources Board Certification and Test Procedures, pursuant to Health and Safety Code Section 41962(g).
  - (B) Transport vessel vapour leaks from dome covers, pressure vacuum vents or other sources shall be determined in accordance with the CARB Vapour Recovery Test Procedure TP-204.3 – Determination of Leak(s).
  - (C) The transport vessel shall be operated so that there are no transport vessel vapour leaks or liquid leaks.
5. Switch Loading
- Uncontrolled switch loading is prohibited except at Class C facilities.
6. Leak Inspection Requirements
- (A) The owner and operator of any Class A, B, or C facility shall be required to perform an inspection of the vapour collection system, the vapour disposal system, and each loading rack handling organic liquids, for facility vapour leaks or liquid leaks of volatile organic compounds on one of the following schedule:
    - (i) monthly if sight, sound, and smell are used as detection methods.
    - (ii) quarterly if an organic vapour analyser (OVA) is used to monitor for facility vapour leaks.
  - (B) Each detection of a leak shall be repaired or replaced within 72 hours. The repaired or replacement component shall be reinspected the first time the component is in operation after the repair or replacement.

**(e) Compliance Schedule**

The owner and operator of any Class A, B, or C facility subject to this rule shall comply with the requirements of subdivision (d) in accordance with the following schedule:

1. For Class A facilities subject to paragraph (d)(1):
  - (A) By July 1, 1996, submit an application to the Executive Officer or designee for permit to construct a new or modified vapour recovery and/or disposal system where applicable.
  - (B) By February 1, 1997, submit a Continuous Monitoring System (CMS) Plan to the Executive Officer or designee for the approval.
  - (C) By February 1, 1998, demonstrate compliance with the organic vapour emission limit of 0.08 pound per thousand gallons of organic liquid transferred.
  - (D) Within 30 calendar days after completing construction of a new or modified vapour recovery and/or disposal system, a written request shall be submitted to CARB for certification of the new or modified vapour recovery and/or disposal system.
  - (E) CARB Certification or District Approval
    - (i) Any vapour recovery and/or disposal system subject to clause (d)(1)(A)(i) shall meet the following requirements:
      - (I) By February 1, 1999, the existing or modified vapour recovery and/or disposal system shall be CARB-certified.
      - (II) No later than 180 calendar days after completion of construction, any vapour recovery and/or disposal system installed after May 14, 1999 shall be CARB-certified, or;
    - (ii) By December 31, 1999 or 180 calendar days after completing construction, whichever is later, the vapour recovery and/or disposal system subject to Clause (d)(1)(A)(ii) shall be District approved.
2. For Class B facilities subject to paragraph (d)(2):
  - (A) Any vapour recovery and/or disposal system subject to clause (d)(2)(A)(i) shall meet the following requirements:
    - (i) By February 1, 1999, the existing or modified vapour recovery and/or disposal system shall be CARB-certified.
    - (ii) No later than 180 calendar days after completion of construction, any vapour recovery and/or disposal system installed after May 14, 1999 shall be CARB-certified, or;
  - (B) By December 31, 1999 or 180 calendar days after completion of construction, whichever is later, the vapour recovery and/or disposal system subject to clause (d)(2)(A)(ii) shall be District-approved.
3. For Class B facilities that were Class C facilities prior to June 9, 1995 and now are subject to paragraph (d)(2):
  - (A) By January 1, 1996, submit an application to the Executive Officer or designee for permit to construct and permit to operate a vapour recovery system where applicable.
  - (B) By February 1, 1998, demonstrate compliance with the requirement of 90 percent recovery of displaced vapours.
  - (C) Within 30 calendar days after completing construction of a new or modified vapour recovery system, a written request shall be submitted to CARB for certification of the new or modified vapour recovery and/or disposal system.
  - (D) CARB Certification or District Approval
    - (i) Any vapour recovery and/or disposal system subject to clause (d)(2)(A)(i) shall meet the following requirements:
      - (I) By February 1, 1999, the existing or modified vapour recovery and/or disposal system shall be CARB-certified.

- (II) No later than 180 calendar days after completion of construction, any vapour recovery and/or disposal system installed after May 14, 1999 shall be CARB-certified, or;
- (ii) By December 31, 1999 or 180 calendar days after completion of construction, whichever is later, the vapour recovery and/or disposal system subject to clause (d)(2)(A)(ii) shall be District-approved.

**(f) Compliance Determination/Test Methods**

1. Compliance with the emission limit of organic vapours as specified in the subparagraph (d)(1)(D) shall be determined according to EPA Method 25A, 25B or SCAQMD Method 501.1, as applicable.
2. Continuous Monitoring System required pursuant to subparagraph (d)(1)(B) shall be in compliance with Code of Federal Regulations Title 40 Part 63 Subpart R Section 63.427 and Code of Federal Regulations Title 40 Part 60 Appendix B, as applicable.
3. Compliance with the vapour recovery efficiency as specified in the subparagraph (d)(2)(B) shall be determined according to the CARB Vapour Recovery Certification Procedure CP-202 – Certification Procedure for Vapour Recovery Systems of Bulk Plants or, for the vapour recovery and/or disposal system subject to Clause (d)(2)(A)(ii), the SCAQMD Approval Procedure for Vapour Recovery Systems of Bulk Plants dated May 14, 1999.
4. Determinations of facility vapour leaks as defined in the paragraph (b)(7) shall be conducted according to EPA Method 21.
5. Compliance with the requirements of District approval for vapour recovery and/or disposal systems as specified in subparagraphs (d)(1)(A) and (d)(2)(A) shall be determined according to the District Approval Procedure for Vapour Recovery Systems for Bulk Plants dated May 14, 1999. All testing required in the District Approval Procedure for Vapour Recovery and/or Disposal System shall be conducted by testing firms/laboratories that have been approved by the District for the specific tests under the Laboratory Approval Program.
6. Any other alternative test method approved in writing by the District, CARB, and EPA may be used only when none of the test methods identified in this subdivision are applicable.
7. When more than one test method or set of test methods are specified for any testing, a violation of any requirements of this rule established by any one of the specified test methods or set of test methods shall constitute a violation of the rule.

**(g) Recordkeeping**

1. The owner and operator of any Class A, B, or C facility, in order to verify the classification of such facility, shall maintain a daily log of the throughput and a summary of the throughput for the calendar year to date, of the liquid organic compounds subject to the provisions of this rule. A log showing daily compliance shall suffice to satisfy this requirement.
2. The owner and operator of any Class A, B, or C facility shall maintain records for verification of compliance with the requirements in paragraph (d)(6). The records shall include, but are not limited to, inspection dates, description of leaks detected, repair/replacement dates, and reinspection dates.
3. All records shall be maintained at the facility for at least two years and shall be available to the Executive Officer or designee upon request.

**(h) Distribution of Responsibilities**

1. The owner and operator of any Class A, B, or C facility shall be responsible and liable for complying with the provisions of paragraphs (d)(1), (d)(2), (d)(3), and (d)(6) and subdivisions (e) and (g) of this rule, and for maintaining the equipment at the facility in such condition that it can comply with the requirements of this rule if properly operated. If employees of the owner or operator of the facility supervise or affect the transfer operation, the owner or operator of the



facility shall be responsible for ensuring that the transfer operation complies with all requirements of this rule and that the transfer equipment is properly operated.

2. The owner, operator, and driver of a transport vessel shall be responsible and liable for complying with paragraphs (d)(4) and (d)(5) of this rule.

**(i) Exemptions**

1. The provisions of subparagraphs (d)(1)(F), (d)(2)(E) and (d)(3)(B) shall not apply to components found in violation of facility vapour leaks or liquid leaks either of which is detected and recorded originally by the owner or operator, provided the repair or replacement of applicable equipment is completed within the specified period as given in subparagraph (d)(6)(B).
2. The provisions of subparagraphs (d)(1)(A), and (d)(1)(B) shall not apply to vapour recovery and/or disposal systems which vent displaced hydrocarbon vapours to an adjacent refinery flare or other combustion device that receives gaseous streams from other refinery sources.

## **Annex D: Proposal for an action plan for diffuse emissions control**

### **Why ?**

The aim of the action plan for diffuse emissions control consists of three subjects:

1. prevent and reduce emissions;
2. manage the operations with respect to the emissions;
3. estimate, monitor and report the emission.

Ad 1: Preventing and reducing emissions is what it is all about. At the same time the acceptable emission level should be clear. Acceptable will be related to acceptable from an air quality point of view (occupational and environmental), acceptable from a technical and economic point of view. The latter is illustrated by the definition of BAT (see glossary), which addresses both. Hence it is important to take the cost-efficiency into consideration.

Ad 2: Managing the operations requires an insight in the correlation between emissions and maintenance and equipment. Emission monitoring will provide the information in order to find an efficient strategy for maintenance, to identify the major leaking sources and to optimise monitoring itself. The information is valuable for considerations for replacement & new investments.

Ad 3: Regular emission reporting is required by the IPPC. It is an important communication tool with the Authorities and the public. In order to be convincing the emission monitoring should be based on good practice methods and be consistent over a range of years.

### **What ?**

The action plan consists of following phases:

1. *gaining insight* in the contribution of different installations of a plant and in the order of magnitude; based on this insight an monitoring approach can be developed.
2. *initial monitoring*: the initial monitoring should cover all potential emission sources.
3. *first evaluation* of the initial monitoring results
4. *first reporting*
5. *regular monitoring*
6. *regular reporting*

### **How ?**

#### ***Gaining insight***

1. Prepare an inventory of all components within the installations. To be inventoried are the number of tanks (fixed roof, floating roof, ...), pumps, compressors, agitators, valves, pressure relief devices, flanges, open-ended lines. Examples of installations are loading&unloading of raw material (e.g. crude oil), loading&unloading of product, storage tanks, process unit 1, process unit 2, waste water treatment and cooling water system.
2. . Estimate diffuse VOC emissions according to the average emission factors. Choose the method that is best suited for the plant. Suitable methods are:
  - fugitive emissions: EPA's [EPA'95],
  - storage, loading&unloading: [EPA-AP42]

- waste water treatment [Concawe'87]
  - cooling water system [Concawe'87].
3. Present the estimated emissions per logical installations/operations and per group of components.
  4. Develop the measuring approach. The recommended approach consists of measuring all components (screening according EPA21) and of measuring the total VOC flux by a remote sensing technique. Remote sensing using the DIAL technique gives the best results by covering all emissions and by pinpointing the major emission source. The screening may be contracted or may be executed by own personnel. Remote sensing is in most cases performed by a contractor because of the expensive equipment.
  5. Discuss the strategy for diffuse emission control with the authorities. Both the methods and the costs to monitor emissions can be discussed.

### ***Initial monitoring***

1. Set up an inventory database of all components. Several companies have developed database applications which will calculate the emissions based on the screening values and which can be used to generate the overviews that are necessary for an in-depth analysis and for the reporting. It is also possible to have a similar database application developed by own personnel.
2. Measure all components and enter all screening data in the database, which can be executed by a mobile computer coupled to the measuring device. The preferred method for calculating emissions based on the screening value is the correlation method [EPA'95]. The correlation method is more accurate than the screening range (stratification) method and requires equal measuring effort.
3. Execute the possible repairs (e.g. fastening of bolts to fasten the seal) and measure the component after the repair; small repairs can be done during the measurements.
4. Mark the components that couldn't be repaired for repair during shut-down and inform the maintenance department.
5. Execute the remote sensing.

### ***First evaluation***

1. Analyse the results of the initial monitoring with respect to the contribution of the various emission sources to the (total) VOC emissions, the reliability of the components, the costs of maintenance & replacement. Special attention should be paid to significant difference in results between the emission estimation according to the average emission factor, according to the screening and according to the remote sensing.
2. Set priorities for emission reduction items (e.g. in three categories: urgent, high and medium priority) and define suitable measures to reduce/prevent emission. The appendix on 'low emission components and techniques' may be of help for finding suitable measures. The measures should cover the system design, installation and maintenance
3. Develop a strategy and action plan for maintenance and monitoring, taking into consideration other environmental priorities also. The strategy and action plan should include the timing of the measures, e.g. measures during normal operations, during cleaning or revamp or recommendations for new investments. System design includes not only suitable low emission equipment but should also include minimisation of potential leakages (e.g. weld pipes rather than using flange connections). The choice of fittings and sealing materials is paramount, as is the careful installation.

***First reporting***

1. Communicate the results to the authorities and discuss the strategy for diffuse emission control and discuss the reporting format. Both the magnitude of the emissions and the costs to monitor and reduce emissions can be discussed.
2. Report the emissions, the strategy and the short-term action plan in the annual environmental report (both to the authorities and to the public).

***Regular monitoring***

1. Measure all components and enter all screening data in the database; execute the repairs if possible (e.g. fastening of bolts to fasten the seal) and measure the component after the repair; mark the components that couldn't be repaired for repair during shut-down and inform the maintenance department.
2. The monitoring can be assisted by methods such as sniffer dogs and VOC sensitive tubes/tapes.

***Regular evaluation and reporting***

1. Analyse the results of the monitoring from the initial monitoring on (trend analysis). Special attention should be paid to significant differences in results between different years and between results according to the screening and according to the remote sensing.
2. Review the set priorities for emission reduction items and measures to reduce/prevent emission.
3. Reconsider the strategy and action plan for maintenance and monitoring, taking into consideration other environmental priorities also.
4. Communicate the results to the authorities and discuss the changes in strategy. Both the magnitude of the emissions and the costs to monitor and reduce emissions can be discussed.
5. Report the emissions, the strategy and the short-term action plan in the annual environmental report (both to the authorities and to the public).



## **Annex E: Comparison of different emission estimation methods**

### **E1 - Introduction**

The United States Environmental Protection Agency issued the Protocol for Equipment Leak Emission Estimates. According to this protocol, different approaches can be used to estimate emissions. These approaches are:

- Average Emission Factor Approach
- Screening Ranges Approach
- Stratified Factors Approach<sup>1</sup>
- EPA Correlation Approach
- Unit-specific Correlation Approach

The calculated emissions may vary by order of magnitude according to the approach used. This annex illustrates the differences by comparing the approaches for three situations of a hypothetical factory. The reader is recommended to consult chapter 2 of the main report for an overview of all estimation methods and paragraph 2.6 for an evaluation of these methods.

All approaches require an accurate count of equipment components by type of equipment (i.e., valves, pumps, connectors, etc.). Additionally, for some of the equipment types, the count must be further described by service (i.e., heavy liquid, light liquid, and gas).

Except for the Average Emission Factor Approach, all of the approaches require screening data. Screening data are collected by using a portable monitoring instrument to sample air from potential leak interfaces on individual pieces of equipment. A screening value is a measure of the concentration of leaking compounds in the ambient air that provides an indication of the leak rate from an equipment piece, and is measured in units of parts per million by volume (ppmv.).

In addition to equipment counts and screening data, the Unit-specific Correlation Approach requires bagging data. Bagging data consist of screening values and their associated measured leak rates. A leak rate is measured by enclosing an equipment piece in a bag to determine the actual mass emission rate of the leak. The screening values and measured leak rates from several pieces of equipment are used to develop a unit-specific correlation. The resulting leak rate/Screening value correlation predicts the mass emission rate as a function of the screening value.

In order to make a comparison of the calculated emissions according to the different approaches, an average population was calculated of over 200,000 potential leak sources in 50 Synthetic Organic Compound Manufacturing Industry (SOCMI) units. These units include production, storage facilities as well as loading and unloading facilities. This average population 'built' a representative unit of 1000 equipment items. The equipment count of this unit is displayed in table E1.

---

<sup>1</sup> The Screening Ranges Approach was introduced in the 1993 revision of the Protocol and was devised to replace the Stratified Factors Approach. In some European countries however, the Stratified Factors Approach is more commonly used than the Screening Ranges Approach. The Stratified Factors Approach is therefore included in this comparison.

**Table E1 - Representative unit of 1000 equipment items**

Equipment type	Service <sup>2</sup>	Number
Compressors	G	1
Pumps	LL	9
Pumps	HL	1
Pressure Relief Devices	G	4
Valves	G	59
Valves	LL	208
Valves	HL	18
Flanges/Connectors	All	698
Sampling Connection	All	2
Total		1000

The emission estimate of this population of equipment items was calculated in 3 different situations:

- Non-leaking
- Average leaking
- Severe leaking.

The screening values in the non-leaking emission estimate were assumed to be 'no detectable emissions'. The population of screening values for the average leaking were calculated from the screening data of the 200,000 potential leak sources. The screening data used for the severe leaking situation was supplied by the most leaking of all units.

For the EPA Correlations approach a typical screening value was used to estimate mass emissions. This screening value was 15,000 ppmv. for the equipment items with a screening value higher than 10,000 ppmv., 3,000 ppmv. for the equipment items with a screening value in between 1,000 ppmv. and 10,000 ppmv., and in the screening range 0 to 1,000 ppmv. the applied screening value was 0 ppmv. for 70 % of the equipment items, and 60 ppmv. for the remainder of the population.

The Unit-Specific Correlation Method was not included in this comparison. The factors and correlation equations developed for the Synthetic Organic Compound Manufacturing Industry have been used. For refineries individual factors and correlation equations are available for all approaches. Marketing terminals and oil and gas production operations only have emission factors for the Average Emission Approach and the Screening Ranges Approach.

---

<sup>2</sup>

G	Gas, material in a gaseous state at operating conditions.
LL	Light Liquid, material in a liquid state in which the sum of the concentration of individual constituents with a vapour pressure over 0,3 kPa at 20°C is greater than or equal to 20 % by weight.
HL	Heavy Liquid, not in gas service or light liquid service.

## E2 - AVERAGE EMISSION FACTORS APPROACH

The Average Emission Factors Approach allows use of average emission factors developed by the EPA in combination with unit-specific data that are relatively simple to obtain. These data include:

1. The number of each equipment type in a unit
2. The service each equipment item is in
3. Time period that the equipment item was in service

The total number for each equipment type and service is then multiplied with the average emission factor. An overview of these factors for Synthetic Organic Compounds Manufacturing Industries (SOCMI) is presented in table 2.

**Table E2 - SOCMI Average Emission Factors**

Equipment type	Service	Emission Factor (kg/h/source)
Compressors	G	0.22800
Pumps	LL	0.01990
Pumps	HL	0.00862
Pressure Relief Devices	G	0.10400
Valves	G	0.00597
Valves	LL	0.00403
Valves	HL	0,00023
Flanges/Connectors	All	0.00183
Open-ended lines	All	0.00170
Sampling Connection	All	0.01500



No screening data are required to execute an Average Emission Factors Estimate. This means that the emission estimate will be the same in all three situations. The total emissions estimated with the Average Emission Approach is presented in table E3.

**Table E3 - SOCFI Average Emission Factors Approach Estimate**

Equipment type	Service	Number	Emission Factor (kg/h/source)	Emission (kg/h)
Compressors	G	1	0.22800	0.22800
Pumps	LL	9	0.01990	0.17910
Pumps	HL	1	0.00862	0.00862
Pressure Relief Devices	G	4	0.10400	0.41600
Valves	G	59	0.00597	0.35223
Valves	LL	208	0.00403	0.83824
Valves	HL	18	0.00023	0.00414
Flanges/Connectors	All	698	0.00183	1.27734
Sampling Connection	All	2	0.01500	0.03000
<b>Total</b>		1000		3.33367

The Average Emission Factors account for the span of possible leak rates, but, as a result, they are not necessarily an accurate indication of the mass emission rate from an individual piece of equipment. Furthermore, the Average Emission Factors do not reflect different site-specific conditions. Site-specific factors can have considerable influence on leak rates from equipment. Therefore, the Average Emission Approach provide an indication of equipment leak emission rates only if screening data are not available.

### E3 - SCREENING RANGES APPROACH

The Screening Ranges Approach offers some refinement over the Average Emission Factor Approach, thereby allowing some adjustment for individual unit conditions and operation. This approach and the other three remaining approaches require that screening data be collected for the equipment items in addition to the data already collected for the Average Emission Approach. The screening data are an indication of leak rates. When applying this approach, it is assumed that components having screening values greater than 10,000 ppmv have a different average emission rate than components with screening ranges less than 10,000 ppmv. Like the Average Emission Approach, the total number for each equipment type, service and greater than or less than 10,000 ppmv. screening value is multiplied with the respective emission factor. An overview of these factors for Synthetic Organic Compounds Manufacturing Industries (SOCMI) is presented in table E4.

**Table E4 - SOCMI Screening Ranges Emission Factors**

Equipment type	Service	< 10,000 ppmv. Emission Factor (kg/h/source)	>= 10,000 ppmv. Emission Factor (kg/h/source)
Compressors	G	0.089400	1.608000
Pumps	LL	0.001870	0.243000
Pumps	HL	0.002100	0.216000
Pressure Relief Devices	G	0.047700	1.691000
Valves	G	0.000131	0.078200
Valves	LL	0.000165	0.089200
Valves	HL	0.000230	0.000230
Flanges/Connectors	All	0.000081	0.113000
Open-ended lines	All	0.001500	0.011950

For our hypothetical unit this is the first time we can estimate emissions for the three situations.

**Table E5 - SOCMI Screening Ranges Emission Factors Approach for non-leaking unit**

Equipment type	Service	Number	< 10,000 ppmv. Emission Factor (kg/h/source)	Emission (kg/h)
Compressors	G	1	0.089400	0.089400
Pumps	LL	9	0.001870	0.016830
Pumps	HL	1	0.002100	0.002100
Pressure Relief Devices	G	4	0.044700	0.178800
Valves	G	59	0.000131	0.007729
Valves	LL	208	0.000165	0.034320
Valves	HL	18	0.000230	0.004140
Flanges/Connectors	All	698	0.000081	0.056538
Sampling Connections	All	2	0.001500	0.003000
<b>Total</b>		1000		0.392857

**Table E6 - SOCMI Screening Ranges Emission Factors Approach for average leaking unit**

Equipment type	Service	Screening Value (ppmv.)	Number	Emission Factor (kg/h/source)	Emission (kg/h)
Compressors	G	< 10,000	1	0.089400	0.089400
		>=10,000	0	1.608000	0,000000
Pumps	LL	< 10,000	8	0.001870	0.014960
		>=10,000	1	0.243000	0.243000
Pumps	HL	< 10,000	1	0.002100	0.002100
		>=10,000	0	0.216000	0,000000
Pressure Relief Devices	G	< 10,000	3	0.044700	0.134100
		>=10,000	1	1.691000	1.691000
Valves	G	< 10,000	58	0,000131	0.007598
		>=10,000	1	0.078200	0.078200
Valves	LL	< 10,000	204	0.000165	0.033660
		>=10,000	4	0.089200	0.356800
Valves	HL	< 10,000	18	0.000230	0.004140
		>=10,000	0	0.000230	0,000000
Flanges/Connectors	All	< 10,000	697	0,000081	0.056457
		>=10,000	1	0.113000	0.113000
Sampling Connections	All	< 10,000	2	0.001500	0.003000
		>=10,000	0	0.011950	0,000000
<b>Total</b>			1000		2.827415

**Table E7 - SOCFI Screening Ranges Emission Factors Approach for severe leaking unit**

Equipment type	Service	Screening Value (ppmv.)	Number	Emission Factor (kg/h/source)	Emission (kg/h)
<b>Compressors</b>	G	< 10,000	0	0.089400	0.000000
		>=10,000	1	1.608000	1.608000
<b>Pumps</b>	LL	< 10,000	6	0.001870	0.011220
		>=10,000	3	0.243000	0.729000
<b>Pumps</b>	HL	< 10,000	1	0.002100	0.002100
		>=10,000	0	0.216000	0,000000
<b>Pressure Relief Devices</b>	G	< 10,000	2	0.044700	0.089400
		>=10,000	2	1.691000	3.382000
<b>Valves</b>	G	< 10,000	56	0.000131	0.007336
		>=10,000	3	0.078200	0.234600
<b>Valves</b>	LL	< 10,000	198	0.000165	0.032670
		>=10,000	10	0.089200	0.892000
<b>Valves</b>	HL	< 10,000	18	0.000230	0.004140
		>=10,000	0	0.000230	0,000000
<b>Flanges/Connectors</b>	All	< 10,000	691	0.000081	0.055971
		>=10,000	7	0.113000	0.791000
<b>Sampling Connections</b>	All	< 10,000	1	0.001500	0.001500
		>=10,000	1	0.011950	0.011950
<b>Total</b>			1000		7.852887

#### E4 - STRATIFIED RANGES APPROACH

The Stratified Ranges Approach offers more refinement over the Screening Ranges Approach for equipment items with a screening value less than 10,000 ppmv.. This approach ofcourse requires that screening data be collected for the equipment items. The screening data are an indication of leak rates. When applying this approach, it is assumed that components having screening values in the different strata have different average emission rate. Like the Average Emission Approach and Screening Ranges Approach, the total number for each equipment type, service and screening value strata is multiplied with the respective emission factor. An overview of these factors for Synthetic Organic Compounds Manufacturing Industries (SOCMI) is presented in table E8.

**Table E8 - SOCMI Stratified Emission Factors**

Equipment type	Service	<= 1,000 ppmv. Emission Factor (kg/h/source)	> 1,000 ppmv. <= 10,000 ppmv. Emission Factor (kg/h/source)	> 10,000 ppmv. Emission Factor (kg/h/source)
<b>Compressors</b>	G	0.01132	0.26400	1.60800
<b>Pumps</b>	LL	0.00198	0.03350	0.43700
<b>Pumps</b>	HL	0.00380	0.09260	0.38550
<b>Pressure Relief Devices</b>	G	0.01140	0.27900	1.69100
<b>Valves</b>	G	0.00014	0.00165	0.04510
<b>Valves</b>	LL	0.00028	0.00963	0.08520
<b>Valves</b>	HL	0.00023	0.00023	0,00023
<b>Flanges/Connectors</b>	All	0.00002	0.00875	0.03750
<b>Open-ended lines</b>	All	0.00013	0.00876	0.01195

Again mass emission estimate calculations were made for the hypothetical unit, using the same screening values as in the former two approaches.

**Table E9 - SOCFI Stratified Emission Factors Approach for non-leaking unit**

Equipment type	Service	Screening Value (ppmv.)	Number	Emission Factor (kg/h/source)	Emission (kg/h)
<b>Compressors</b>	G	<= 1,000 ppmv	1	0.01132	0.01132
		1.001–10,000 ppmv.	0	0.26400	0.00000
		>10,000 ppmv.	0	1.60800	0,00000
<b>Pumps</b>	LL	<= 1,000 ppmv	9	0.00198	0.01782
		1.001–10,000 ppmv.	0	0.03350	0.00000
		>10,000 ppmv	0	0.43700	0.00000
<b>Pumps</b>	HL	<= 1,000 ppmv	1	0.00380	0.00380
		1.001–10,000 ppmv.	0	0.09260	0.00000
		>10,000 ppmv	0	0.38550	0.00000
<b>Pressure Relief Devices</b>	G	<= 1,000 ppmv	4	0.01140	0.04560
		1.001–10,000 ppmv.	0	0.27900	0.00000
		>10,000 ppmv	0	1.69100	0.00000
<b>Valves</b>	G	<= 1,000 ppmv	59	0,00014	0.00826
		1.001–10,000 ppmv.	0	0.00165	0.00000
		>10,000 ppmv	0	0.04510	0.00000
<b>Valves</b>	LL	<= 1,000 ppmv	208	0.00028	0.05824
		1.001–10,000 ppmv.	0	0.00963	0.00000
		>10,000 ppmv	0	0.08520	0.00000
<b>Valves</b>	HL	<= 1,000 ppmv	18	0.00023	0.00414
		1.001–10,000 ppmv.	0	0.00023	0.00000
		>10,000 ppmv	0	0.00023	0.00000
<b>Flanges/Connectors</b>	All	<= 1,000 ppmv	698	0.00002	0.01396
		1.001–10,000 ppmv.	0	0.00875	0.00000
		>10,000 ppmv	0	0.03750	0.00000
<b>Open-ended lines</b>	All	<= 1,000 ppmv	2	0.00013	0.00026
		1.001–10,000 ppmv.	0	0.00876	0.00000
		>10,000 ppmv	0	0.01195	0.00000
<b>Total</b>			1000		0.16340

**Table E10 - SOCMI Stratified Emission Factors Approach for average leaking unit**

Equipment type	Service	Screening Value (ppmv.)	Number	Emission Factor (kg/h/source)	Emission (kg/h)
<b>Compressors</b>	G	<= 1,000 ppmv	0	0.01132	0.00000
		1.001–10,000 ppmv.	1	0.26400	0.26400
		>10,000 ppmv.	0	1.60800	0.00000
<b>Pumps</b>	LL	<= 1,000 ppmv	6	0.00198	0.01188
		1.001–10,000 ppmv.	2	0.03350	0.06700
		>10,000 ppmv	1	0.43700	0.43700
<b>Pumps</b>	HL	<= 1,000 ppmv	1	0.00380	0.00380
		1.001–10,000 ppmv.	0	0.09260	0.00000
		>10,000 ppmv	0	0.38550	0.00000
<b>Pressure Relief Devices</b>	G	<= 1,000 ppmv	2	0.01140	0.02280
		1.001–10,000 ppmv.	1	0.27900	0.27900
		>10,000 ppmv	1	1.69100	1.69100
<b>Valves</b>	G	<= 1,000 ppmv	55	0.00014	0.00770
		1.001–10,000 ppmv.	3	0.00165	0.00495
		>10,000 ppmv	1	0.04510	0.04510
<b>Valves</b>	LL	<= 1,000 ppmv	196	0.00028	0.05488
		1.001–10,000 ppmv.	8	0.00963	0.07704
		>10,000 ppmv	4	0.08520	0.34080
<b>Valves</b>	HL	<= 1,000 ppmv	18	0.00023	0.00414
		1.001–10,000 ppmv.	0	0.00023	0.00000
		>10,000 ppmv	0	0.00023	0.00000
<b>Flanges/Connectors</b>	All	<= 1,000 ppmv	691	0.00002	0.01382
		1.001–10,000 ppmv.	6	0.00875	0.05250
		>10,000 ppmv	1	0.03750	0.03750
<b>Open-ended lines</b>	All	<= 1,000 ppmv	1	0.00013	0.00013
		1.001–10,000 ppmv.	1	0.00876	0.00876
		>10,000 ppmv	0	0.01195	0.00000
<b>Total</b>			1000		3.42380

**Table E10 - SOcMI Stratified Emission Factors Approach for severe leaking unit**

Equipment type	Service	Screening Value (ppmv.)	Number	Emission Factor (kg/h/source)	Emission (kg/h)
<b>Compressors</b>	G	<= 1,000 ppmv	0	0.01132	0.00000
		1.001–10,000 ppmv.	0	0.26400	0.00000
		>10,000 ppmv.	1	1.60800	1.60800
<b>Pumps</b>	LL	<= 1,000 ppmv	3	0.00198	0.00594
		1.001–10,000 ppmv.	3	0.03350	0.10050
		>10,000 ppmv	3	0.43700	1.31100
<b>Pumps</b>	HL	<= 1,000 ppmv	0	0.00380	0.00000
		1.001–10,000 ppmv.	1	0.09260	0.09260
		>10,000 ppmv	0	0.38550	0,00000
<b>Pressure Relief Devices</b>	G	<= 1,000 ppmv	1	0.01140	0.01140
		1.001–10,000 ppmv.	1	0.27900	0.27900
		>10,000 ppmv	2	1.69100	3.38200
<b>Valves</b>	G	<= 1,000 ppmv	47	0.00014	0.00658
		1.001–10,000 ppmv.	9	0.00165	0.01485
		>10,000 ppmv	3	0.04510	0.13530
<b>Valves</b>	LL	<= 1,000 ppmv	183	0.00028	0.05124
		1.001–10,000 ppmv.	15	0.00963	0.14445
		>10,000 ppmv	10	0.08520	0.85200
<b>Valves</b>	HL	<= 1,000 ppmv	16	0.00023	0.00368
		1.001–10,000 ppmv.	2	0.00023	0.00046
		>10,000 ppmv	0	0.00023	0.00000
<b>Flanges/Connectors</b>	All	<= 1,000 ppmv	679	0.00002	0.01358
		1.001–10,000 ppmv.	12	0.00875	0.10500
		>10,000 ppmv	7	0.03750	0.26250
<b>Open-ended lines</b>	All	<= 1,000 ppmv	0	0.00013	0.00000
		1.001–10,000 ppmv.	1	0.00876	0.00876
		>10,000 ppmv	1	0.01195	0.01195
<b>Total</b>			1000		8.40079



### E5 - EPA CORRELATION APPROACH

This approach offers an additional refinement to estimating emissions from equipment leaks by providing an equation to predict mass emission rate as a function of screening value for a particular equipment type, thus providing a more realistic estimate. The EPA Correlation Approach is the most preferred estimation method if actual screening data are available. An overview of the factors for zero screening value and screening value correlation equations is presented in table E11.

**Table E11 - SOCMI Leak Rate / Screening Value Correlations**

Equipment type	Service	Default-zero emission rates (kg/h/source)	Leak Rate / Screening Value Correlations (kg/h/source)
Compressors	G	7.5E-06	1.90E-05 * (SV) <sup>0.824</sup>
Pumps	LL	7.5E-06	1.90E-05 * (SV) <sup>0.824</sup>
Pumps	HL	7.5E-06	1.90E-05 * (SV) <sup>0.824</sup>
Pressure Relief Devices	G	7.5E-06	1.90E-05 * (SV) <sup>0.824</sup>
Valves	G	6.6E-07	1.87E-06 * (SV) <sup>0.873</sup>
Valves	LL	4.9E-07	6.41E-06 * (SV) <sup>0.797</sup>
Valves	HL	4.9E-07	6.41E-06 * (SV) <sup>0.797</sup>
Flanges/Connectors	All	6.1E-07	3.05E-06 * (SV) <sup>0.885</sup>
Open-ended lines	All	7.5E-06	1.90E-05 * (SV) <sup>0.824</sup>

(SV) = Screening Value

The emission was calculated for the hypothetical unit in the three situations.

**Table E12 - SOCMI Correlation Approach for non-leaking unit**

Equipment type	Service	Number	Emission (kg/h/source)
Compressors	G	1	0.000008
Pumps	LL	9	0.000068
Pumps	HL	1	0.000008
Pressure Relief Devices	G	4	0.000030
Valves	G	59	0.000039
Valves	LL	208	0.000102
Valves	HL	18	0.000135
Flanges/Connectors	All	698	0.000426
Open-ended lines	All	2	0.000015
<b>Total</b>		<b>1000</b>	<b>0.000829</b>

**Table E13 - SOCMI Correlation Approach for average leaking unit**

Equipment type	Service	Number	Emission (kg/h/source)
Compressors	G	1	0.013928
Pumps	LL	9	0.082073
Pumps	HL	1	0.000008
Pressure Relief Devices	G	4	0.058172
Valves	G	59	0.015491
Valves	LL	208	0.093609
Valves	HL	18	0.003005
Flanges/Connectors	All	698	0.053991
Open-ended lines	All	2	0.013951
<b>Total</b>		<b>1000</b>	<b>0.334229</b>

**Table E14 - SOCMI Correlation Approach for severe leaking unit**

Equipment type	Service	Number	Emission (kg/h/source)
Compressors	G	1	0.052463
Pumps	LL	9	0.282911
Pumps	HL	1	0.013928
Pressure Relief Devices	G	4	0.177581
Valves	G	59	0.059922
Valves	LL	208	0.295187
Valves	HL	18	0.033717
Flanges/Connectors	All	698	0.240261
Open-ended lines	All	2	0.080342
<b>Total</b>		<b>1000</b>	<b>1.236313</b>

## E6 - CONCLUSION

The calculated emissions for the hypothetical unit are summarised in table E15.

**Table E15 - Comparison of emission calculation methods for the hypothetical plant (as fraction of the correlation method result for the average leaking situation).**

Calculation method	No leaking sources	Average leaking sources	Severe leaking sources
Average emission factor	10	10	10
Screening range method	1.2	8.5	23
Stratified factor method	0.49	10	25
Correlation method	0.0025	1	3.7

Of all approaches presented in this document, the EPA Correlation Approach is the most preferred if screening values are available. The EPA Correlation Approach provides the most accurate estimation, and is therefore the best approach for estimating mass emissions and reduce total VOC emissions. Due to the difference in results of the estimation methods, it is only possible to quantify emission reduction caused by maintenance if the same estimation method is used.

## Annex F: European VOC emissions and reduction targets

### F1 - VOC emission sources

In order to put the diffuse VOC emissions into perspective a brief overview of the contribution of the different countries and sectors is presented. The data is an extract of the European Environment Agency (EEA) database. The Agency monitors the state of the environment [e.g. EEA'98: Europe's Environment: the second assessment]. One of the tools is a Europe wide inventory of atmospheric emissions (Corinair).

In order to judge the contribution the compounds to be considered are actually NMVOC, i.e. VOC without methane. The European methane emissions account for about two thirds of the VOC emissions [EEA'98]; methane has a different environmental impact and the main sources are different (natural gas distribution networks, coal mining and agriculture). The main NMVOC emission sources are presented in figure F1.

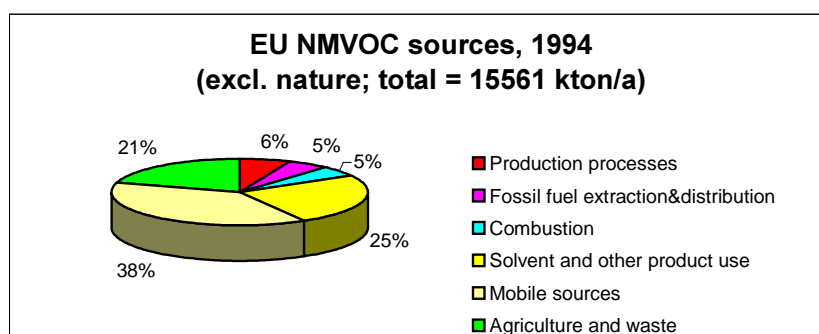

**Figure F1 - Sector split of NMVOC emissions of EU – 1994 (Corinair'94).**

The contribution of industrial non-combustion sources (industrial processes + extraction and distribution of fossil fuels) amounts to about 11%. The geographical distribution of the industrial non-combustion sources is presented in figure 1.3.

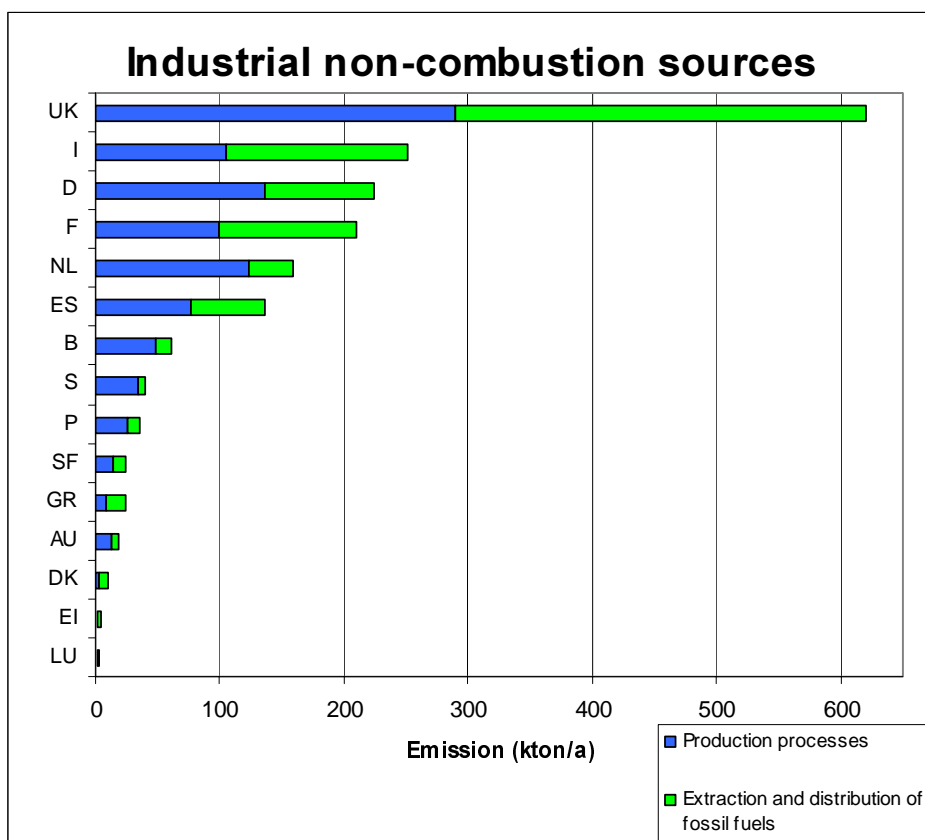

**Figure F2 – Distribution of industrial non-combustion NMVOC emissions excluding solvent use; 1994 [Corinair'94].**

The main emission sources of industrial NMVOC emissions excluding solvent use are storage, loading & unloading and process equipment (fugitive emissions). The contribution of fugitive emissions on site level varies but the order of magnitude for a large integrated chemical plant is about 5-25%. An example for a Swedish refinery is presented in figure F3. As well as for the production processes as for the distribution of refinery products the contribution of fugitive emissions is approximately 8% of the total VOC emission [Corinair'94].

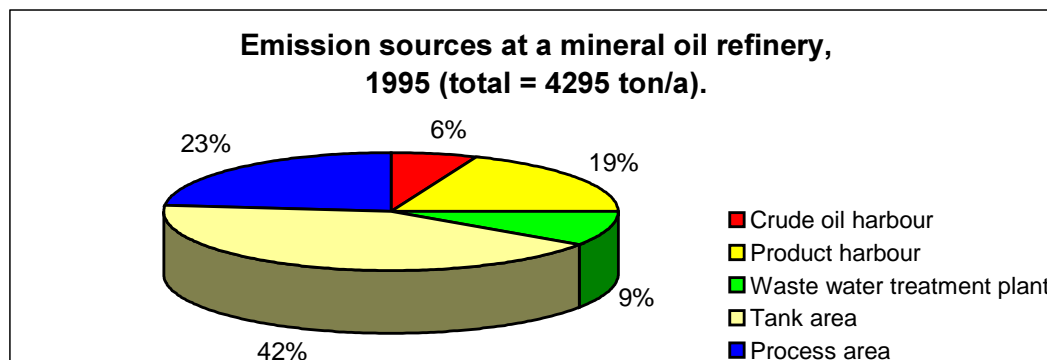

(Based on DIAL measurements [Janson'99])

**Figure F3 - Emission sources at a factory: a Swedish mineral oil refinery (10 Mton crude oil/a).**

## F2 - VOC targets

Reduction of VOC emissions is on the agenda of several European forums. The fifth environmental action programme (5EAP) of the EU-establishes a VOC reduction target of 30% by 2000 relative to 1990 levels. The EU is presently developing an ozone abatement strategy which will involve significant (up to 50-75% by 2010) emission reductions of VOC and NO<sub>x</sub> (precursors of ozone). It can be noticed that the policy focus changed from a pollutant-oriented approach (most existing EU legislation) towards an effects-oriented approach (ozone abatement strategy).

With respect to the 30% reduction by 2000 of the fifth environmental action programme it is unlikely that the EU or all EU member states will achieve the target [EEA'98].

Besides the EU forum, the UN-ECE Convention on long-range transboundary air pollution (LRTAP) should be mentioned. The Convention Protocol to Abate Acidification, Eutrophication and Ground-level Ozone aims to cut emissions of sulphur, nitrogen oxides, volatile organic compounds (VOCs) and ammonia from energy generation, industrial sources, motor vehicles, agriculture and products. The Protocol sets reduction targets for all four pollutants. By 2010, Europe's VOC emissions should be cut by 40% compared to their 1990 levels. The Protocol has been signed by several EU member states.

The national targets of the Protocol are presented in the following table.

**Table F1 - Extract of the VOC Targets of the Protocol to Abate Acidification, Eutrophication and Ground-level Ozone (kton/a).**

<b>Party</b>	<b>Emission levels 1990</b>	<b>Emission ceilings 2010</b>	<b>Emission reductions 1990-2010</b>
Austria	351	159	-55%
Belgium	324	144	-56%
Denmark	178	85	-52%
Finland	209	130	-38%
France	2957	1100	-63%
Germany	3195	995	-69%
Greece	373	261	-30%
Ireland	197	55	-72%
Italy	2213	1159	-48%
Luxembourg	20	9	-55%
Netherlands	502	191	-62%
Portugal	640	202	-68%
Spain <sup>1)</sup>	1094	669	-39%
Sweden	526	241	-54%
United Kingdom	2555	1200	-53%
European Community	15353	6600	-57%

1) Figures apply to the European part.

Various countries have adopted national or regional targets, e.g. the Nordic countries have agreed on a regional target to reduce VOC-emissions by approximately 50% before 2005 compared to 1988, the Netherlands have completed a programme to reduce VOC emissions by 80% before 2010 compared to 1980.

## **Annex G: Questionnaire (June-November 1999)**

The presented questionnaire served as a checklist of the topics which were discussed by telephone. The aim of the discussion was to get an overview of:

- emissions estimation methods,
- abatement measures
- licensing and enforcement practices.

Specific national procedures or standards dedicated to industrial diffuse VOC emissions and an example of the requirements of an existing environmental permit have been asked for.



**1. Emission estimation**

- 1) How do you identify the permitted industries which have relevant diffuse VOC emissions?
- 2) How many industries with relevant diffuse emissions exist in your jurisdictional area (order of magnitude)?
- 3) In order to have an impression of the common situation, how many installations estimate and report the diffuse emissions on a regular basis to the authorities in the present situation and in the near future?
  - present situation: All/most/half/some/none.
  - near future (next 5 years): All/most/half/some/none.
- 4) How are the diffuse emissions estimated?  
(common methods are described in the background document, chapter 2).

**Method for**

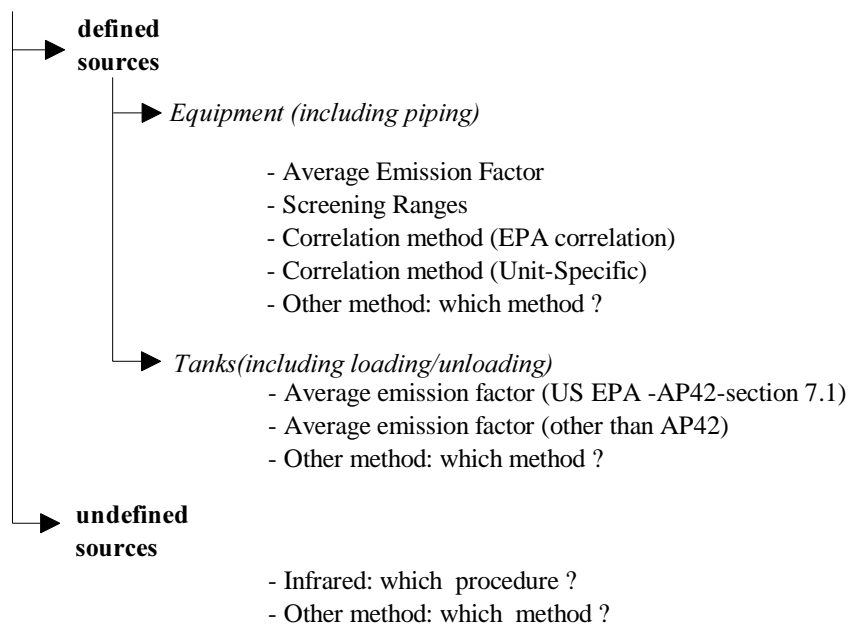

- 5) Are specific procedures/standards/guidelines used in your country; if so please mention the references.

## 2. Emissions reducing measures

- 1) Which emission reducing measures have been taken by the relevant industries in the present situation and are expected to be taken in the near future (next 5 years)?

### Emission reducing measure

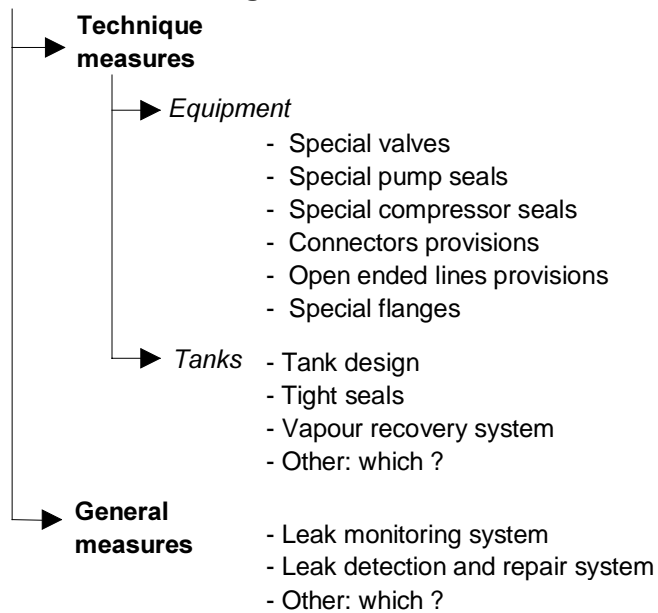

- 2) Are specific procedures/standards/guidelines used in your country; if so please mention the references.

### 3. Licensing and enforcement practice<sup>3</sup>

- 1) Which requirements related to diffuse emissions are included in environmental permits in the present situation and in the near future?
  - Annual emission estimation (self-monitoring) and reporting to the Authorities
  - Measuring programme
  - Leak detection and repair programme
  - 'Low emission' techniques: which techniques
  - Emission target (absolute value or relative value)
  - No requirements
  - Other requirements: which.
  
- 2) Does the competent authority supplement its enforcement program with technical assistance now or does it plan to in the near future
  - Eco-audit
  - Training program, seminar or other educational forum
  - Reliance on third parties
  - Other: which.
  
- 3) How is compliance of the permit requirements monitored in the present situation and in the near future (next 5 years)?
  - Site inspection by the Competent Authority: how
  - Inspection of company data by the Competent Authority
  - Validation of company data by third party
  - No monitoring
  - Other: which.
  
- 4) In case of non-compliance of the permit requirements, which additional measures are required?
  - Leak detection and repair programme
  - Validation of company data by third party
  - No additional requirements
  - Other requirements: which.

---

<sup>3</sup> General enforcement protocol for permit violations (e.g. warning notice, penalty, ...) is not within the scope of this project.

## Annex H: Extract of the first draft BREF notes on mineral oil refineries.

The main paragraphs on diffuse VOC emissions of the first draft BAT reference document on mineral oil refineries of 18 February 2000 are attached. The paragraphs are :

- 4.16- point 6 -Prevention, detection and control of fugitive emissions.
- 4.23.3 - VOC abatement techniques.

The complete document can be downloaded from <http://eippcb.jrc.es> (>activities > refineries).

### 6 - Prevention, detection and control of fugitive emissions

The aim in all refinery processes should be to prevent or minimise the release of VOCS. Because of the size, scope and nature of hydrocarbon processing on refineries, this presents a major challenge which requires an overall strategy that also devolves down into individual action at a process unit and plant item level. Most VOCs are released through fugitive losses from sources including valves, flanges, pump seals and equipment vents. Even a small simple refinery may have over 10000 potential sources and the problem is magnified proportionally on the complete complex refineries.

The principal areas of fugitive loss are well known and their minimising has been the subject of much investigation and action on refineries world-wide, mainly led by operators subject to extremely tight regulation, e.g. certain US states and parts of Europe. Some techniques to consider can be:

- An essential first step of any programme is to establish a fugitive release inventory for the refinery. This normally involves a combination of sampling, measurements, environmental monitoring, dispersion modeling and estimates based on emission factors.
- the identifying of all potential sources of VOC releases, by establishing population counts of equipment components in line with up-to-date P & I drawings for processes. This survey should cover gas, vapour and light liquid duties;
- quantifying of the VOC releases, initially as "baseline" estimates, and subsequently to more refined levels. Suitable protocols for this include the US EPA Method 21(22) for process component losses and API methods(9) for tankage losses. Some major companies have developed their own techniques and protocols;
- using appropriate dispersion modeling techniques, predict atmospheric mass flux and concentrations;
- employing environmental monitoring techniques, compare the predicted situation with the measured one.
- Identification of the processes that have higher fugitive releases.
- VOC releases should also be minimised from refinery utility and ancillary systems and during plant maintenance and cleaning operations. Hydrocarbons should be minimised in cooling water and adequate separation facilities provided to deal with incidents of contamination. After depressurising off-line process vessels to RFG/flare, they should normally be steamed out to flare and residual liquids returned to oil slops plants, not run to drain before venting to air, when personnel entry is required.
- Vapour recovery/incineration/use
- A strategy to reduce VOC emissions may include a complete inventory and quantification by a DIAL LIDAR (differential absorption light detection and ranging) technique. In all cases, emissions estimates using API methods give lower emissions than estimates based on the DIAL monitoring. In some case the discrepancies are very large. By using the method for estimating fugitive

emissions proposed by EPA "Workbook for estimating fugitive emissions from petroleum production operations, 1992" the emissions from the process area at Preem refinery [Janson, 1999] have been estimated to 125 tonnes per year. Extrapolations of the DIAL measurements to a yearly emission give emissions of 500-600 tonnes per year. Emissions that occur through relief valves are to be routed to flare or dedicated incineration systems, and in exceptional cases vented to a safe location.

- Fugitive VOC emissions (sometimes containing H<sub>2</sub>S) can be minimised through double mechanical seals on valves, pumps, compressors, etc.

#### *Establish leak detection and repair program*

In the case of process component fugitive releases the only real option, is the implementation of a permanent on-going Leak Detection and Repair (LDAR) programme. This should be developed and tailored to suit the situation concerned, using appropriate techniques, frequencies and priorities. It should provide estimates of fugitive VOC releases for monitoring returns and enable action to be taken to minimise releases.

Fugitive emissions are one of the largest sources of refinery hydrocarbon emissions. A leak detection and repair (LDAR) program consists of using a portable VOC detecting instrument to detect leaks during regularly scheduled inspections of valves, flanges, and pump seals. Leaks are then repaired immediately or are scheduled for repair as quickly as possible. A LDAR program could reduce fugitive emissions 40 to 64 percent, depending on the frequency of inspections.

LDAR programmes have been used successfully world-wide to reduce VOC releases. Typical survey results show that leaks from glands on valves and pumps are responsible for 90% or more of estimated fugitive releases and that a small proportion of valves, virtually all on gas or high temperature light material streams, contribute almost all of the total. The available techniques used to minimise such process component fugitive releases include:

- use of low emission valve stem packing (500 ppm) on critical valves, e.g. rising stem gate type control valves in continuous operation, particularly on gas/light liquid high pressure/temperature duties. Valves is the type of equipment that causes most of the leaks (40-65%) [Janson, 1999]
- use of alternative proven types of low-release valves where gate valves are not essential, e.g. quarter turn and sleeved plug valves, both of which have two independent seals;
- use of balanced bellows type relief valves to minimise valve leakage outside the design lift range and piping of reliefs to RFG or flare gas, normally via phase separation, without header back pressure;
- minimising the number of flanged connections on pipelines and the use of high specification jointing materials;
- use of canned pumps or double seals on conventional pumps. Study the use of magnetic pumps;
- piping of compressor seals, vent and purge lines to RFG or flare systems;
- use of end caps or plugs on open ended lines and closed loop flush on liquid sampling points;
- minimising the releases to air from process hydrocarbon analysers, by optimising sampling volume/frequency and venting to RFG or flare systems.

Process emissions (fugitive): double seals or improved mechanical seals and glands in pumps, and improved packing materials at valves and flanges, supported by a leak detection and repair (LDAR) maintenance management scheme;

### 4.23.3 VOC abatement techniques

#### 1.- Vapour treatment units

##### Waste stream application

Vapour recovery units (VRUs) are installations designed for the emission reduction of volatile organic compounds (VOC) which are emitted during loading and unloading operations of light products. For a refinery this is particularly relevant to gasoline storage and loading as well as for products with equivalent volatility characteristics such as naphtha and BTEX. As VOC emission abatement by VRUs is only one aspect of total VOC control in a refinery this section should be considered in combination with Storage, Handling and Integrated Refinery management.

##### Purpose and principle

When transferring liquids to vessels at atmospheric pressure, the existing mixture of vapour and gas (often air, but also inerts) in the receiving vessel is often emitted to atmosphere. Such loading operation is recognised as having an impact on the environment due to the presence of VOC, a precursor of ozone. EU Stage 1 Directive 94/63/EC requires that Member States prescribe the specific emission reduction measures is laid down in the annexes of the Directive. Also the application of VRUs to prevent escape of these vapours to the atmosphere is specified in the directive. VRUs aim for recovery of hydrocarbons for reuse. In some cases recovery is not economic, and preference will be given to vapour destruction units (VDU). A more general term covering both options is Vapour Handling Systems (VHS).

In the Netherlands, the KWS2000 programme applies to storage and loading operations of liquid hydrocarbons with a vapour pressure > 1 kPa (10 mbar) at ambient temperature. Moreover, the specific requirements on gasoline storage and loading are laid down in the national legislation following the Stage-1 Directive. For refineries the VOC emissions of gasoline and their abatement is by far the most important due to the high vapour pressure (>27.6 kPa), the large throughput and the large number of transshipments by truck, rail and barge.

##### System description

A survey and characterisation of the main commercially available Vapour Handling Systems (VHS) lists the following types and combinations, used to process the expelled vapours in combination with vapour balancing lines:

##### *Vapour recovery units (VR U)*

- Adsorption: The vapour molecules adhere physically to activate sites on the surface of solid materials, like activated carbon (AC) or zeolite. Due to heat of adsorption this method cannot handle high inlet concentrations (auto-ignition). At higher inlet concentrations the AC is quickly saturated, so regeneration is necessary. Normally, adsorption VRUs applies therefore to a two-stage system.
- Absorption: The vapour molecules dissolve in a suitable absorption liquid (water, lyes, glycols or mineral oil fractions such as reformate ). If reformate is used recycling to blending tanks is done. If water is used regeneration of the absorption liquid is not necessary , as water can be treated in a waste water treatment plant. Regeneration more than doubles the investment + energy costs.
- Refrigeration/condensation: By cooling of the vapour/gas mixture the vapour molecules condense and are separated as a liquid. This method can achieve low exit concentrations if the applied refrigeration temperature is low enough. A great advantage of condensation is that the vapours are recovered as pure liquids (no waste), which can easily be returned directly to the storage tank.

- Membrane gas separation: This new technology is now used at a number of refineries. The vapour molecules dissolve into the
- membrane, move by diffusion to the other side and desorb into the support material, driven by a pressure difference. The concentration is higher at the desorption side of the membrane, as the vapour molecules are preferentially absorbed into the membrane compared to the gas molecules.
- Hybrid systems. Nowadays, combinations of above VRUs are on the market which are able to meet very low emissions standards. Examples are cooling/absorption and compression/absorption/membrane separation.

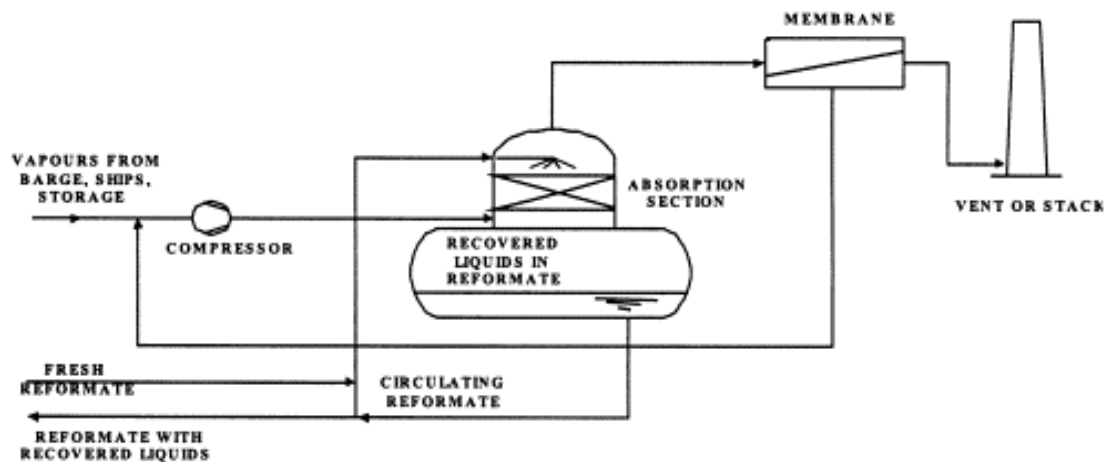

**Figure 4.9: Simplified process flow scheme of a vapour recovery unit (Compression/absorption/membrane type)**

#### *Vapour Destruction (VD)*

In addition to vapour recovery also vapour destruction can be applied. Two systems are relevant in this respect:

- Oxidation: The vapour molecules are converted to CO<sub>2</sub> and H<sub>2</sub>O either by thermal oxidation at high temperatures or by catalytic oxidation at lower temperatures. Thermal oxidation can give unwanted combustion products such as NO<sub>x</sub>, requiring extra treatment. Catalytic oxidation requires less energy to arrive at combustion temperatures, and can be competitive with thermal oxidation at low inlet concentrations. Thermal oxidation requires good primary and/or secondary safety measures to prevent explosions, while the efficiency of catalyst oxidation may be reduced by catalyst poisoning and ageing. The stage 1 directive on allows oxidation in special situations, e.g. when energy is recovered by a gas motor.
- Biofiltration: Decomposition to CO<sub>2</sub> and H<sub>2</sub>O is achieved at temperatures slightly above ambient by micro-organisms located in a solid humidified mass. The method is high] suited for treatment of continuous constant-composition air streams with low concentration of organic pollutants. The method is not suitable for the direct treatment of the vapour/a mixtures often encountered in transshipments, because such mixtures have mostly high vapour concentrations (> 1 vol%) and appear as sudden peak flows during the rather infrequent unloading operations.

#### Operability, health and safety

The following removal efficiencies can be noted for the VHS systems discussed above: Adsorption 99.95-99.99 %, Absorption 99-99.95%, Thermal oxidation 99.8-99.99%, Catalytic oxidation 95-99%, Refrigeration/Condensation 99.8-99.95%, Biofilters 95-99%, Membrane gas separation 99-99.9%. The

handling of VOC involves always safety measures in view of explosion risks (flame arresters) and the presence of toxic compounds such as benzene.

#### Energy and process materials utilisation

VRUs are compact and require very little energy and process materials to operate.

#### Environmental aspects

Emissions of the various systems are directly related to the reduction efficiency as reported above and can be as low as 10 g/Nm<sup>3</sup> (for VRU) or even 50 mg/Nm<sup>3</sup> (VD). Effluent is usually only condensate and is usually negligible. Waste is only relevant in case absorption bed or biofilters are exhausted. Usually operating times are longer than two years.

#### Costs

VRUs occupy limited space. Usually they are preassembled and delivered skid mounted. Commercial VRU capacities range from 500- 2000 Nm<sup>3</sup>/h. A typical VRU with a capacity of 1000 Nm<sup>3</sup>/h involves a capital cost of EUR 2 million with an installation factor of 1.5 (as package unit) to 5 (in exceptional cases). Capital investment strongly depends on site specific factors, such as the number of loading berths connected to the system, the distance between berth and the emission control facility (cost of ducting), the need for blowers, safety systems (explosion and flame arresters) systems. The capital costs can range from EUR 4-20 million for a VRU of 2000 Nm<sup>3</sup>/h capacity.



DESCRIPTION		K EUR	%
<b>INDIRECT COSTS</b>			
	230 Detailed Engineering	275	7
	213 Field Supervision	137	3
	213 Inspection	83	2
	260 PMT - NPQC - Owner	424	10
	Subtotal	919	22
<b>DIRECT COSTS - EQUIPMENT</b>			
	311 Heat Exchangers	0	0
	314 Towers	0	0
	315 Drums	0	0
	316 Reactors	943	22
	324 Pumps and Drivers	13	<1
	326 Tanks and Spheres	0	0
	347 Cooling Towers	0	0
	Subtotal	956	22
<b>DIRECT COSTS - NON EQUIPMENT</b>			
	208 Scaffolding	25	<1
	209 Cleanup Construction	8	<1
	216 Construction Equipment	16	<1
	307 Excavation & Cable Trenches	142	3
	308 Concrete Work and Paving	216	5
	309 Piling	33	1
	313 Piping	1179	28
	318 Structural Steel	77	2
	322 Instrumentation	285	7
	328 Roads, Walks, Fences	15	<1
	337 Electric Power and Light	107	3
	345 Communication Equipment	0	0
	348 Insulation	3	<1
	349 Paint	167	4
	380 Standby Equipment (Cap. Spare)	0	0
	Subtotal	2273	54
	Total Capital	4148	98
<b>EXPENSE</b>			
	101 Dismantling	17	<1
	102 Site Clearance	0	0
	103 Relocation	7	<1
	104 Reconditioning	0	0
	105 Temporary Bypasses	0	0
	111 Gas Freeing & Cleaning	8	41
	165 Owner Expense Charges	81	2
	Subtotal	113	2
	<b>Final Total</b>	<b>4261</b>	<b>100</b>

**Table 4.6: Total erected cost of a Vapour Recovery Unit [Martin and Schipper, 1999]**

#### Suppliers

*Membrane gas separation in hybrid systems:* Aluminium Rheinfelden (Vaconocore), Preussag; *Refrigeration* (liquid nitrogen): AGA Gas, Hoek Loos, L'oxhydrique; *Thermal oxidation:* Brinkman & Germeraad Milieutechniek BV, IT McGill, John Zink; *Condensation-Absorption:* Coolsorption, Wiese, GVWU, Kappa Gi, Mar Research, Schwelm Anlaen, Citex; *Condensation:* Holter, IBK Compac; *Adsorption-Absorption:* IT McGill, John Zink, Kappa Gi, Kaldair. *Biofiltration:* ClairTech.

#### Status

Scores of VRUs at gasoline (un)loading installations for VOC emission reduction have been built in W - Europe following Stage-I legislation. Hybrid systems are popular due to simplicity, good operability and high performance.

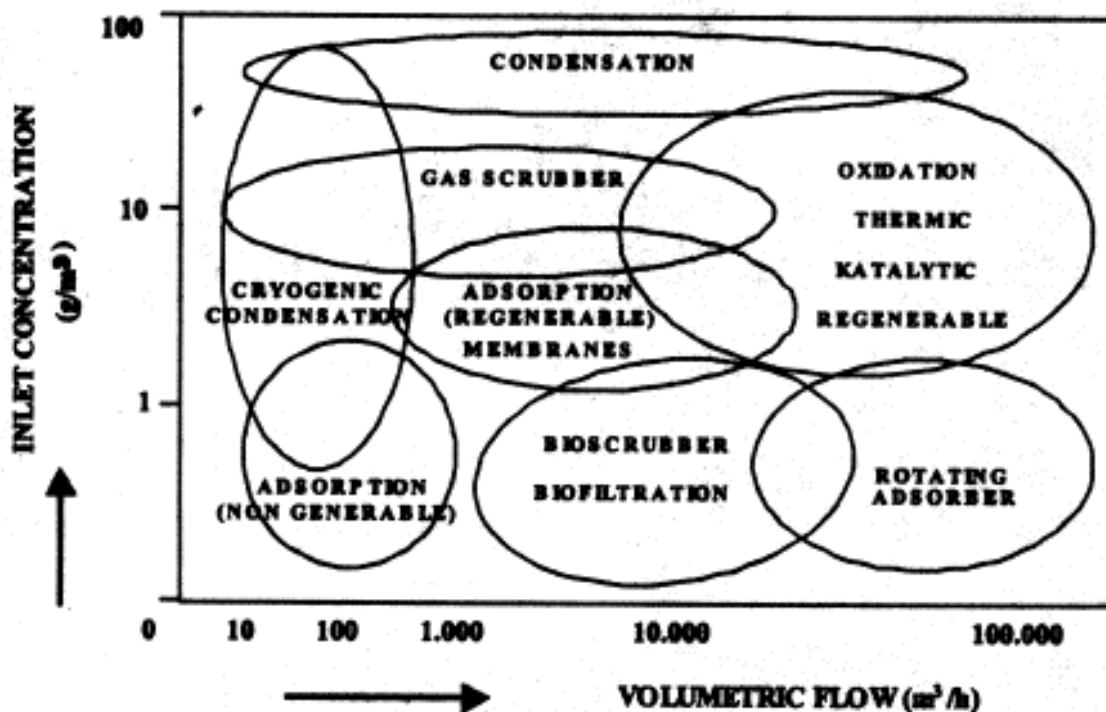

Figure 4.10: Applicability different techniques for end-of-pipe gas treatment for VOC removal

Another control technique is to collect VOCs from vents, pumps and compressors and to route them to a flare system. Costs are given in Table 4.7.

Emission Source	Refinery Process Units and Equipment (Installed and Retrofitted)	
Control Technology	Leak Detection and Repair Programmes	Collection of atmospheric VOCs and relief valves to flare/incineration system
Efficiency	50- 90%	up to 99.5% destruction efficiency in incineration
Investment Costs	Moderate	1.3 M EUR for 5 Mt/a refinery <sup>(2)</sup>
Operating Costs	0.1-0.15 M EUR for 300000 BPSD Refinery <sup>(1)</sup> 0.06 M EUR for 5 Mt/a refinery <sup>(2)</sup> 0.04 -0.08 M EUR/y for a 10000 ppm programme to 0.8 M EUR/y for a 100-500 ppm programme <sup>(3)</sup>	3.0 M EUR <sup>(2)</sup>
Other Impacts	Costs of repair not included in above	Increase in CO <sub>2</sub> emissions due to combustion

Table 4.7: VOC Controls in Refinery Process Units

Source: (1) Industry Propriety Information (2) UN-ECE EC AIR/WG6/1998/5 (3) Hydrocarbon Processing, September 1996, p 121